

**ENVIRONMENTAL PROTECTION AGENCY**

**40 CFR Parts 2, 59, 60, 80, 85, 86, 600, 1027, 1030, 1031, 1033, 1036, 1037, 1039, 1042, 1043, 1045, 1048, 1051, 1054, 1060, 1065, 1066, 1068, and 1090**

[EPA-HQ-OAR-2019-0055; FRL-7165-02-OAR]

RIN 2060-AU41

**Control of Air Pollution From New Motor Vehicles: Heavy-Duty Engine and Vehicle Standards**

**AGENCY:** Environmental Protection Agency (EPA).

**ACTION:** Final rule.

**SUMMARY:** The Environmental Protection Agency (EPA) is finalizing a program to further reduce air pollution, including ozone and particulate matter (PM), from heavy-duty engines and vehicles across the United States. The final program includes new emission standards that are significantly more stringent and that cover a wider range of heavy-duty engine operating conditions compared to today's standards; further, the final program requires these more stringent emissions standards to be met for a longer period of when these engines operate on the road. Heavy-duty vehicles and engines are important contributors to concentrations of ozone and particulate matter and their resulting threat to public health, which includes premature death, respiratory illness (including childhood asthma), cardiovascular problems, and other adverse health impacts. The final rulemaking promulgates new numeric standards and changes key provisions of the existing heavy-duty emission control program, including the test procedures, regulatory useful life, emission-related warranty, and other requirements. Together, the provisions in the final rule will further reduce the air quality impacts of heavy-duty engines across a range of operating conditions and over a longer period of the operational life of heavy-duty engines. The requirements in the final rule will lower emissions of NO<sub>x</sub> and other air pollutants (PM, hydrocarbons (HC), carbon monoxide (CO), and air toxics) beginning no later than model year 2027. We are also finalizing limited amendments to the regulations that implement our air pollutant emission standards for other sectors (e.g., light-duty vehicles, marine diesel engines, locomotives, and various other types of nonroad engines, vehicles, and equipment).

**DATES:** This final rule is effective on March 27, 2023. The incorporation by reference of certain material listed in this rule is approved by the Director of the Federal Register as of March 27, 2023.

**ADDRESSES:** Docket: EPA has established a docket for this action under Docket ID No. EPA-HQ-OAR-2019-0055. Publicly available docket materials are available either electronically at [www.regulations.gov](http://www.regulations.gov) or in hard copy at Air and Radiation Docket and Information Center, EPA Docket Center, EPA/DC, EPA WJC West Building, 1301 Constitution Ave., NW, Room 3334, Washington, DC. Out of an abundance of caution for members of the public and our staff, the EPA Docket Center and Reading Room are open to the public by appointment only to reduce the risk of transmitting COVID-19. Our Docket Center staff also continues to provide remote customer service via email, phone, and webform. Hand deliveries and couriers may be received by scheduled appointment only. For further information on EPA Docket Center services and the current status, please visit us online at [www.epa.gov/dockets](http://www.epa.gov/dockets).

**FOR FURTHER INFORMATION CONTACT:** Brian Nelson, Assessment and Standards Division, Office of Transportation and Air Quality, Environmental Protection Agency, 2000 Traverwood Drive, Ann Arbor, MI 48105; telephone number: (734) 214-4278; email address: [nelson.brian@epa.gov](mailto:nelson.brian@epa.gov).

**SUPPLEMENTARY INFORMATION:**

**Does this action apply to me?**

This action relates to companies that manufacture, sell, or import into the United States new heavy-duty highway engines. Additional amendments apply for gasoline refueling facilities and for manufacturers of all sizes and types of motor vehicles, stationary engines, aircraft and aircraft engines, and various types of nonroad engines, vehicles, and equipment. Regulated categories and entities include the following:

NAICS codes <sup>a</sup>	NAICS title
326199 .....	All Other Plastics Product Manufacturing.
332431 .....	Metal Can Manufacturing.
333618 .....	Manufacturers of new marine diesel engines.
335312 .....	Motor and Generator Manufacturing.
336111 .....	Automobile Manufacturing.
336112 .....	Light Truck and Utility Vehicle Manufacturing.

NAICS codes <sup>a</sup>	NAICS title
336120 .....	Heavy Duty Truck Manufacturing.
336211 .....	Motor Vehicle Body Manufacturing.
336213 .....	Motor Home Manufacturing.
336411 .....	Manufacturers of new aircraft.
336412 .....	Manufacturers of new aircraft engines.
333618 .....	Other Engine Equipment Manufacturing.
336999 .....	All Other Transportation Equipment Manufacturing.
423110 .....	Automotive and Other Motor Vehicle Merchant Wholesalers.
447110 .....	Gasoline Stations with Convenience Stores.
447190 .....	Other Gasoline Stations.
454310 .....	Fuel dealers.
811111 .....	General Automotive Repair.
811112 .....	Automotive Exhaust System Repair.
811198 .....	All Other Automotive Repair and Maintenance.

<sup>a</sup>NAICS Association. NAICS & SIC Identification Tools. Available online: <https://www.naics.com/search>.

This table is not intended to be exhaustive, but rather provides a guide for readers regarding entities likely to be regulated by this action. This table lists the types of entities that EPA is now aware could potentially be regulated by this action. Other types of entities not listed in the table could also be regulated. To determine whether your entity is regulated by this action, you should carefully examine the applicability criteria found in Sections XI and XII of this preamble. If you have questions regarding the applicability of this action to a particular entity, consult the person listed in the **FOR FURTHER INFORMATION CONTACT** section.

**Public participation: Docket:** All documents in the docket are listed on the [www.regulations.gov](http://www.regulations.gov) website. Although listed in the index, some information is not publicly available, e.g., CBI or other information whose disclosure is restricted by statute. Certain other material, such as copyrighted material, is not placed on the internet and will be publicly available only in hard copy form through the EPA Docket Center at the location listed in the **ADDRESSES** section of this document.

**What action is the agency taking?**

The Environmental Protection Agency (EPA) is adopting a rule to reduce air pollution from highway heavy-duty vehicles and engines. The final rulemaking will promulgate new numeric standards and change key provisions of the existing heavy-duty emission control program, including the

test procedures, regulatory useful life, emission-related warranty, and other requirements. Together, the provisions in the final rule will further reduce the air quality impacts of heavy-duty engines across a range of operating conditions and over a longer period of the operational life of heavy-duty engines. Heavy-duty vehicles and engines are important contributors to concentrations of ozone and particulate matter and their resulting threat to public health, which includes premature death, respiratory illness (including childhood asthma), cardiovascular problems, and other adverse health impacts. This final rule will reduce emissions of nitrogen oxides and other pollutants.

#### What is the agency's authority for taking this action?

Clean Air Act section 202(a)(1) requires that EPA set emission standards for air pollutants from new motor vehicles or new motor vehicle engines that the Administrator has found cause or contribute to air pollution that may endanger public health or welfare. See Sections I.D and XIII of this preamble for more information on the agency's authority for this action.

#### What are the incremental costs and benefits of this action?

Our analysis of the final standards shows that annual total costs for the final program relative to the baseline (or no action scenario) range from \$3.9 billion in 2027 to \$4.7 billion in 2045 (2017 dollars, undiscounted, see Table V–16). The present value of program costs for the final rule, and additional details are presented in Section V. Section VIII presents our analysis of the human health benefits associated with the final standards. We estimate that in 2045, the final rule will result in total annual monetized ozone- and PM<sub>2.5</sub>-related benefits of \$12 and \$33 billion at a 3 percent discount rate, and \$10 and \$30 billion at a 7 percent discount rate (2017 dollars, discount rate applied to account for mortality cessation lag, see Table VIII–3).<sup>1</sup> These benefits only reflect those associated with reductions in NO<sub>x</sub> emissions (a precursor to both ozone and secondarily-formed PM<sub>2.5</sub>) and directly-emitted PM<sub>2.5</sub> from highway heavy-duty engines. The agency was unable to quantify or monetize all the benefits of the final program, therefore the monetized

benefit values are underestimates. There are additional human health and environmental benefits associated with reductions in exposure to ambient concentrations of PM<sub>2.5</sub>, ozone, and NO<sub>2</sub> that data, resource, or methodological limitations have prevented EPA from quantifying. There will also be benefits associated with reductions in air toxic pollutant emissions that result from the final program, but we did not attempt to monetize those impacts because of methodological limitations. More detailed information about the benefits analysis conducted for the final rule, including the present value of program benefits, is included in Section VIII and RIA Chapter 8. We compare total monetized health benefits to total costs associated with the final rule in Section IX. Our results show that annual benefits of the final rule will be larger than the annual costs in 2045, with annual net benefits of \$6.9 and \$29 billion assuming a 3 percent discount rate, and net benefits of \$5.8 and \$25 billion assuming a 7 percent discount rate.<sup>2</sup> The benefits of the final rule also outweigh the costs when expressed in present value terms and as equalized annual values (see Section IX for these values). See Section VIII for more details on the net benefit estimates

#### Did EPA conduct a peer review before issuing this action?

This regulatory action was supported by influential scientific information. EPA therefore conducted peer review in accordance with OMB's Final Information Quality Bulletin for Peer Review. Specifically, we conducted peer review on five analyses: (1) Analysis of Heavy-Duty Vehicle Sales Impacts Due to New Regulation (Sales Impacts), (2) Exhaust Emission Rates for Heavy-Duty Onroad Vehicles in MOVES\_CTI NPRM (Emission Rates), (3) Population and Activity of Onroad Vehicles in MOVES\_CTI NPRM (Population and Activity), (4) Cost teardowns of Heavy-Duty Valvetrain (Valvetrain costs), and (5) Cost teardown of Emission Aftertreatment Systems (Aftertreatment Costs). All peer review was in the form of letter reviews conducted by a contractor. The peer review reports for each analysis are in the docket for this action and at EPA's Science Inventory (<https://cfpub.epa.gov/si/>).

#### Table of Contents

- I. Executive Summary
  - A. Introduction
  - B. Overview of the Final Regulatory Action
  - C. Impacts of the Standards

- D. EPA Statutory Authority for This Action
- II. Need for Additional Emissions Control
  - A. Background on Pollutants Impacted by This Proposal
  - B. Health Effects Associated With Exposure to Pollutants Impacted by This Rule
  - C. Environmental Effects Associated With Exposure to Pollutants Impacted by This Rule
  - D. Environmental Justice
- III. Test Procedures and Standards
  - A. Overview
  - B. Summary of Compression-Ignition Exhaust Emission Standards and Duty Cycle Test Procedures
  - C. Summary of Compression-Ignition Off-Cycle Standards and Off-Cycle Test Procedures
  - D. Summary of Spark-Ignition HDE Exhaust Emission Standards and Test Procedures
  - E. Summary of Spark-Ignition HDV Refueling Emission Standards and Test Procedures
- IV. Compliance Provisions and Flexibilities
  - A. Regulatory Useful Life
  - B. Ensuring Long-Term In-Use Emissions Performance
  - C. Onboard Diagnostics
  - D. Inducements
  - E. Fuel Quality
  - F. Durability Testing
  - G. Averaging, Banking, and Trading
- V. Program Costs
  - A. Technology Package Costs
  - B. Operating Costs
  - C. Program Costs
- VI. Estimated Emissions Reductions From the Final Program
  - A. Emission Inventory Methodology
  - B. Estimated Emission Reductions From the Final Program
  - C. Estimated Emission Reductions by Engine Operations and Processes
- VII. Air Quality Impacts of the Final Rule
  - A. Ozone
  - B. Particulate Matter
  - C. Nitrogen Dioxide
  - D. Carbon Monoxide
  - E. Air Toxics
  - F. Visibility
  - G. Nitrogen Deposition
  - H. Demographic Analysis of Air Quality
- VIII. Benefits of the Heavy-Duty Engine and Vehicle Standards
- IX. Comparison of Benefits and Costs
  - A. Methods
  - B. Results
- X. Economic Impact Analysis
  - A. Impact on Vehicle Sales, Mode Shift, and Fleet Turnover
  - B. Employment Impacts
- XI. Other Amendments
  - A. General Compliance Provisions (40 CFR Part 1068) and Other Cross-Sector Issues
  - B. Heavy-Duty Highway Engine and Vehicle Emission Standards (40 CFR Parts 1036 and 1037)
  - C. Fuel Dispensing Rates for Heavy-Duty Vehicles (40 CFR Parts 80 and 1090)
  - D. Refueling Interface for Motor Vehicles (40 CFR Parts 80 and 1090)
  - E. Light-Duty Motor Vehicles (40 CFR Parts 85, 86, and 600)
  - F. Large Nonroad Spark-Ignition Engines (40 CFR Part 1048)

<sup>1</sup> 2045 is a snapshot year chosen to approximate the annual health benefits that occur when the final program will be fully implemented and when most of the regulated fleet will have turned over.

<sup>2</sup> The range of benefits and net benefits reflects a combination of assumed PM<sub>2.5</sub> and ozone mortality risk estimates and selected discount rate.

- G. Small Nonroad Spark-Ignition Engines (40 CFR Part 1054)
  - H. Recreational Vehicles and Nonroad Evaporative Emissions (40 CFR Parts 1051 and 1060)
  - I. Marine Diesel Engines (40 CFR Parts 1042 and 1043)
  - J. Locomotives (40 CFR Part 1033)
  - K. Stationary Compression-Ignition Engines (40 CFR Part 60, subpart IIII)
  - L. Nonroad Compression-Ignition Engines (40 CFR Part 1039)
- XII. Statutory and Executive Order Reviews
- A. Executive Order 12866: Regulatory Planning and Review and Executive Order 13563: Improving Regulation and Regulatory Review
  - B. Paperwork Reduction Act (PRA)
  - C. Regulatory Flexibility Act (RFA)
  - D. Unfunded Mandates Reform Act (UMRA)
  - E. Executive Order 13132: Federalism
  - F. Executive Order 13175: Consultation and Coordination With Indian Tribal Governments
  - G. Executive Order 13045: Protection of Children From Environmental Health and Safety Risks
  - H. Executive Order 13211: Actions Concerning Regulations That Significantly Affect Energy Supply, Distribution, or Use
  - I. National Technology Transfer and Advancement Act (NTTAA) and 1 CFR Part 51
  - J. Executive Order 12898: Federal Actions To Address Environmental Justice in Minority Populations and Low-Income Populations
  - K. Congressional Review Act
  - L. Judicial Review
- XIII. Statutory Provisions and Legal Authority

## I. Executive Summary

### A. Introduction

#### 1. Summary of the Final Criteria Pollutant Program

In this action, the EPA is finalizing a program to further reduce air pollution, including pollutants that create ozone and particulate matter (PM), from heavy-duty engines and vehicles across the United States. The final program includes new, more stringent emissions standards that cover a wider range of heavy-duty engine operating conditions compared to today's standards, and it requires these more stringent emissions standards to be met for a longer period of time of when these engines operate on the road.

This final rule is part of a comprehensive strategy, the "Clean Trucks Plan," which lays out a series of clean air and climate regulations that the agency is developing to reduce pollution from large commercial heavy-duty trucks and buses, as well as to advance the transition to a zero-emissions transportation future. Consistent with President Biden's

Executive Order (E.O.) 14037, this final rule is the first step in the Clean Trucks Plan.<sup>3</sup> We expect the next two steps of the Clean Trucks Plan will take into consideration recent Congressional action, including the recent Inflation Reduction Act of 2022, that we anticipate will spur significant change in the heavy-duty sector.<sup>4</sup> We are not taking final action at this time on the proposed targeted updates to the existing Heavy-Duty Greenhouse Gas Emissions Phase 2 program (HD GHG Phase 2); rather, we intend to consider potential changes to certain HD GHG Phase 2 standards as part of a subsequent rulemaking.

Across the United States, heavy-duty engines emit oxides of nitrogen (NO<sub>x</sub>) and other pollutants that are significant contributors to concentrations of ozone and PM<sub>2.5</sub> and their resulting adverse health effects, which include death, respiratory illness (including childhood asthma), and cardiovascular problems.<sup>5 6 7</sup> Without this final rule, heavy-duty engines would continue to be one of the largest contributors to mobile source NO<sub>x</sub> emissions nationwide in the future, representing 32 percent of the mobile source NO<sub>x</sub> emissions in calendar year 2045.<sup>8</sup> Furthermore, we estimate that without this final rule, heavy-duty engines would represent 90 percent of the onroad NO<sub>x</sub> inventory in calendar year 2045.<sup>9</sup> Reducing NO<sub>x</sub> emissions is a

<sup>3</sup> President Joseph Biden. Executive Order on Strengthening American Leadership in Clean Cars and Trucks. 86 FR 43583, August 10, 2021.

<sup>4</sup> For example, both the 2021 Infrastructure Investment and Jobs Act (commonly referred to as the "Bipartisan Infrastructure Law" or BIL) and the Inflation Reduction Act of 2022 ("Inflation Reduction Act" or IRA) include many incentives for the development, production, and sale of zero emissions vehicles (ZEVs) and charging infrastructure. Infrastructure Investment and Jobs Act, Public Law 117–58, 135 Stat. 429 (2021) ("Bipartisan Infrastructure Law" or "BIL"), available at <https://www.congress.gov/117/plaws/publ58/PLAW-117publ58.pdf>; Inflation Reduction Act of 2022, Public Law 117–169, 136 Stat. 1818 (2022) ("Inflation Reduction Act" or "IRA"), available at <https://www.congress.gov/117/bills/hr5376/BILLS-117hr5376enr.pdf>.

<sup>5</sup> Oxides of nitrogen (NO<sub>x</sub>) refers to nitric oxide (NO) and nitrogen dioxide (NO<sub>2</sub>).

<sup>6</sup> Zawacki et al., 2018. Mobile source contributions to ambient ozone and particulate matter in 2025. *Atmospheric Environment*, Vol 188, pg 129–141. Available online: <https://doi.org/10.1016/j.atmosenv.2018.04.057>.

<sup>7</sup> Davidson et al., 2020. The recent and future health burden of the U.S. mobile sector apportioned by source. *Environmental Research Letters*. Available online: <https://doi.org/10.1088/1748-9326/ab83a8>.

<sup>8</sup> Sectors other than onroad and nonroad were projected from 2016v1 Emissions Modeling Platform. <https://www.epa.gov/air-emissions-modeling/2016v1-platform>.

<sup>9</sup> U.S. EPA (2020) Motor Vehicle Emission Simulator: MOVES3. <https://www.epa.gov/moves>.

critical part of many areas' strategies to attain and maintain the National Ambient Air Quality Standards (NAAQS) for ozone and PM; many state and local agencies anticipate challenges in attaining the NAAQS in the future, and/or preventing nonattainment.<sup>10</sup> Some nonattainment areas have already been "bumped up" to higher classifications because of challenges in attaining the NAAQS.<sup>11</sup>

In addition, emissions from heavy-duty engines can result in higher pollutant levels for people living near truck freight routes. Based on a study EPA conducted of people living near truck routes, an estimated 72 million people live within 200 meters of a truck freight route.<sup>12</sup> Relative to the rest of the population, people of color and those with lower incomes are more likely to live near truck routes.<sup>13</sup> This population includes children; childcare facilities and schools can also be in close proximity to freight routes.<sup>14</sup>

The final rulemaking will promulgate new numeric standards and change key provisions of the existing heavy-duty emission control program, including the test procedures, regulatory useful life, emission-related warranty, and other requirements. Together, the provisions in the final rule will further reduce the air quality impacts of heavy-duty engines across a range of operating conditions and over a longer portion of the operational life of heavy-duty engines.<sup>15</sup> The requirements in the final

<sup>10</sup> See Section II for additional detail.

<sup>11</sup> For example, in September 2019 several 2008 ozone nonattainment areas were reclassified from moderate to serious, including Dallas, Chicago, Connecticut, New York/New Jersey and Houston, and in January 2020, Denver. Also, on September 15, 2022, EPA finalized reclassification of 5 areas in nonattainment of the 2008 ozone NAAQS from serious to severe and 22 areas in nonattainment of the 2015 ozone NAAQS from marginal to moderate. The 2008 NAAQS for ozone is an 8-hour standard with a level of 0.075 ppm, which the 2015 ozone NAAQS lowered to 0.070 ppm.

<sup>12</sup> See discussion in Section II.B.7.

<sup>13</sup> See Section VII.H for additional discussion on our analysis of environmental justice impacts of this final rule.

<sup>14</sup> Kingsley, S., Eliot, M., Carlson, L. et al. Proximity of U.S. schools to major roadways: a nationwide assessment. *J Expo Sci Environ Epidemiol* 24, 253–259 (2014). <https://doi.org/10.1038/jes.2014.5>.

<sup>15</sup> Note that the terms useful life and operational life are different, though they are related. As required by Clean Air Act (CAA) section 202(a), the useful life period is when manufacturers are required to meet the emissions standards in the final rule; whereas, operational life is the term we use to describe the duration over which an engine is operating on roadways. We are finalizing useful life periods that cover a greater portion of the operational life. We consider operational life to be the average mileage at rebuild for compression-ignition engines and the average mileage at replacement for spark-ignition engines (see preamble Section IV.A for details).

rule will lower emissions of NO<sub>x</sub> and other air pollutants (PM, hydrocarbons (HC), carbon monoxide (CO), and air toxics) beginning no later than model year (MY) 2027. The emission reductions from the final rule will increase over time as more new, cleaner vehicles enter the fleet.

We estimate that the final rule will reduce NO<sub>x</sub> emissions from heavy-duty vehicles in 2040 by more than 40 percent; by 2045, a year by which most of the regulated fleet will have turned over, heavy-duty NO<sub>x</sub> emissions will be almost 50 percent lower than they would have been without this action. These emission reductions will result in widespread decreases in ambient concentrations of pollutants such as ozone and PM<sub>2.5</sub>. We estimate that in 2045, the final rule will result in total annual monetized ozone- and PM<sub>2.5</sub>-related benefits of \$12 and \$33 billion at a 3 percent discount rate, and \$10 and \$30 billion at a 7 percent discount rate. These widespread air quality improvements will play an important role in addressing concerns raised by state, local, and Tribal governments, as well as communities, about the contributions of heavy-duty engines to air quality challenges they face such as meeting their obligations to attain or continue to meet NAAQS, and to reduce other human health and environmental impacts of air pollution. This rule's emission reductions will reduce air pollution in close proximity to major roadways, where concentrations of many air pollutants are elevated and where people of color and people with low income are disproportionately exposed.

In EPA's judgment, our analyses in this final rule show that the final standards will result in the greatest degree of emission reduction achievable starting in model year 2027, giving appropriate consideration to costs and other factors, which is consistent with EPA's statutory authority under Clean Air Act (CAA) section 202(a)(3)(A).<sup>16</sup>

CAA section 202(a)(1) requires the EPA to "by regulation prescribe (and from time to time revise) . . . standards applicable to the emission of any air

<sup>16</sup> CAA section 202(a)(3)(A) requires standards for emissions of NO<sub>x</sub>, PM, HC, and CO emissions from heavy-duty vehicles and engines to "reflect the greatest degree of emission reduction achievable through the application of technology which the Administrator determines will be available for the model year to which such standards apply, giving appropriate consideration to cost, energy, and safety factors associated with the application of such technology." Throughout this notice we use terms like "maximum feasible emissions reductions" to refer to this statutory requirement to set standards that "reflect the greatest degree of emission reduction achievable . . . ."

pollutant from any class or classes of new motor vehicles or new motor vehicle engines . . . , which in his judgment cause, or contribute to, air pollution which may reasonably be anticipated to endanger public health or welfare." CAA section 202(a)(3)(C) requires that NO<sub>x</sub>, PM, HC, and CO (hereafter referred to as "criteria pollutants") standards for certain heavy-duty vehicles and engines apply for no less than 3 model years and apply no earlier than 4 years after promulgation.<sup>17</sup>

Although heavy-duty engines have become much cleaner over the last decade, catalysts and other technologies have evolved such that harmful air pollutants can be reduced even further. The final standards are based on technology improvements that have become available over the 20 years since the last major rule was promulgated to address emissions of criteria pollutants and toxic pollutants from heavy-duty engines, as well as projections of continued technology improvements that build on these existing technologies. The criteria pollutant provisions we are adopting in this final rule apply for all heavy-duty engine (HDE) classes: Spark-ignition (SI) HDE, as well as compression-ignition (CI) Light HDE, CI Medium HDE, and CI Heavy HDE.<sup>18</sup>

As described in Section III, the final standards will reduce emissions during a broader range of operating conditions

<sup>17</sup> See Sections I.D and XIII for additional discussion on EPA's statutory authority for this action, including our authority under CAA sections 202(d) and 207.

<sup>18</sup> This final rule includes new criteria pollutant standards for engine-certified Class 2b through 8 heavy-duty engines and vehicles. Class 2b and 3 vehicles with a Gross Vehicle Weight Rating (GVWR) between 8,500 and 14,000 pounds are primarily commercial pickup trucks and vans and are sometimes referred to as "medium-duty vehicles." The majority of Class 2b and 3 vehicles are chassis-certified vehicles, and EPA intends to include them in a future combined light-duty and medium-duty rulemaking action, consistent with E.O. 14037, Section 2a. SI HDE are typically fueled by gasoline, whereas CI HDE are typically fueled by diesel; note that the Heavy HDE class, which is largely CI engines, does include certain SI engines that are generally natural gas-fueled engines intended for use in Class 8 vehicles. See 40 CFR 1036.140 for additional description of the primary intended service classes for heavy-duty engines. Heavy-duty engines and vehicles are also used in nonroad applications, such as construction equipment; nonroad heavy-duty engines and vehicles are not the focus of this final rule. As outlined in I.B of this Executive Summary and detailed in Section XI, this final rule also includes limited amendments to regulations that implement our air pollutant emission standards for other industry sectors, including light-duty vehicles, light-duty trucks, marine diesel engines, locomotives, and various types of nonroad engines, vehicles, and equipment. See 40 CFR 1036.140 for a description of the primary intended service classes for heavy-duty engines.

compared to the current standards, such that nearly all in-use operation will be covered. Available data indicate that emission levels demonstrated for certification are not currently achieved under the broad range of real-world operating conditions.<sup>19 20 21 22</sup> In fact, less than ten percent of the data collected during a typical test while the vehicle is operated on the road is subject to EPA's current on-the-road emission standards.<sup>23</sup> These testing data further show that NO<sub>x</sub> emissions from heavy-duty CI engines are high during many periods of vehicle operation that are not subject to current on-the-road emission standards. For example, "low-load" engine conditions occur when a vehicle operates in stop-and-go traffic or is idling; these low-load conditions can result in exhaust temperature decreases that then lead to the diesel engine's selective catalytic reduction (SCR)-based emission control system becoming less effective or ceasing to function. Test data collected as part of EPA's manufacturer-run in-use testing program indicate that this low-load operation could account for more than half of the NO<sub>x</sub> emissions from a vehicle during a typical workday.<sup>24</sup> Similarly, heavy-duty SI engines also operate in conditions where their catalyst technology becomes less effective, resulting in higher levels of air pollutants; however, unlike CI engines, it is sustained medium-to-high load operation where emission levels are less certain. To address these concerns, as part of our comprehensive approach, the final standards include both revisions to our existing test procedures and new test procedures to reduce emissions

<sup>19</sup> Hamady, Fakhri, Duncan, Alan. "A Comprehensive Study of Manufacturers In-Use Testing Data Collected from Heavy-Duty Diesel Engines Using Portable Emissions Measurement System (PEMS)." 29th CRC Real World Emissions Workshop, March 10–13, 2019.

<sup>20</sup> Sandhu, Gurdas, et al. "Identifying Areas of High NO<sub>x</sub> Operation in Heavy-Duty Vehicles". 28th CRC Real-World Emissions Workshop, March 18–21, 2018.

<sup>21</sup> Sandhu, Gurdas, et al. "In-Use Emission Rates for MY 2010+ Heavy-Duty Diesel Vehicles". 27th CRC Real-World Emissions Workshop, March 26–29, 2017.

<sup>22</sup> As noted in Section I.B and discussed in Section III, testing engines and vehicles while they are operating without a defined duty cycle is referred to as "off-cycle" testing; as detailed in Section III, we are finalizing new off-cycle test procedures and standards as part of this rulemaking.

<sup>23</sup> Heavy-duty CI engines are currently subject to off-cycle standards that are not limited to specific test cycles; throughout this notice we use the terms "on-the-road", "over the road", or "real world" interchangeably to refer to off-cycle standards.

<sup>24</sup> Sandhu, Gurdas, et al. "Identifying Areas of High NO<sub>x</sub> Operation in Heavy-Duty Vehicles". 28th CRC Real-World Emissions Workshop, March 18–21, 2018.

from heavy-duty engines under a broader range of operating conditions, including low-load conditions.

Data also show that tampering and mal-maintenance of the engine's emission control system after the useful life period is projected to result in NO<sub>x</sub> emissions that would represent a substantial part of the HD emissions inventory in 2045.<sup>25</sup> To address this problem, as part of our comprehensive approach, the final rule includes longer regulatory useful life and emission-related warranty requirements to ensure the final emissions standards will be met through more of the operational life of heavy-duty vehicles.<sup>26 27</sup> Further, the final rule includes requirements for manufacturers to better ensure that operators keep in-use engines and emission control systems working properly in the real world. We expect these final provisions to improve maintenance and serviceability will reduce incentives to tamper with the emission control systems on MY 2027 and later engines, which would avoid large increases in emissions that would impact the reductions projected from the final rule. For example, we estimate NO<sub>x</sub> emissions will increase more than 3000 percent due to malfunction of the NO<sub>x</sub> emissions aftertreatment on a MY 2027 and later heavy-duty vehicle. To address this, the final rule requires manufacturers to meet emission standards with less frequent scheduled maintenance for emission-related parts and systems, and to provide more information on how to diagnose and repair emission control systems. In addition, the final rule requires manufacturers to demonstrate that they design their engines to limit access to electronic controls to prevent operators from reprogramming the engine to bypass or disable emission controls. The final rule also specifies a balanced approach for manufacturers to design their engines with features to ensure

that operators perform ongoing maintenance to keep SCR emission control systems working properly, without creating a level of burden and corresponding frustration for operators that could increase the risk of operators completely disabling emission control systems. These provisions combined with the longer useful life and warranty periods will provide a comprehensive approach to ensure that the new, much more stringent emissions standards are met during in use operations.

The final standards and requirements are based on further consideration of the data included in the proposed rule, as well as additional supporting data from our own test programs, and consideration of the extensive public input EPA received in response to the proposed rule. The proposal was posted on the EPA website on March 7, 2022, and published in the **Federal Register** on March 28, 2022 (87 FR 17414, March 28, 2022). EPA held three virtual public hearings in April 2022. We received more than 260,000 public comments.<sup>28</sup> A broad range of stakeholders provided comments, including state and local governments, heavy-duty engine manufacturers, emissions control suppliers and others in the heavy-duty industry, environmental organizations, environmental justice organizations, state, local, and Tribal organizations, consumer groups, labor groups, private citizens, and others. Some of the issues raised in comments included the need for new, more stringent NO<sub>x</sub> standards, particularly in communities already overburdened by pollution; the feasibility and costs of more stringent NO<sub>x</sub> standards combined with much longer useful life periods; the longer emissions-related warranty periods; a single- vs. two-step program; and various details on the flexibilities and other program design features of the proposed program. We briefly discuss several of these key issues in Section I.B, with more detail in later sections in this preamble and in the Response to Comments document that is available in the public docket for this rule.<sup>29</sup>

This Section I provides an overview of the final program, the impacts of the final program, and how the final program is consistent with EPA's statutory requirements. The need for

additional emissions control from heavy-duty engines is described in Section II. We describe the final standards and compliance flexibilities in detail in Sections III and IV. We discuss our analyses of estimated emission reductions, air quality improvements, costs, and monetized benefits of the final program in Sections V through X. Section XI describes limited amendments to the regulations that implement our air pollutant emission standards for other sectors (e.g., light-duty vehicles, marine diesel engines, locomotives, and various types of nonroad engines, vehicles, and equipment).

## 2. EPA Will Address HD GHG Emissions in a Subsequent Rulemaking

Although we proposed targeted revisions to the MY2027 GHG Phase 2 standards as part of the same proposal in which we laid out more stringent NO<sub>x</sub> standards, in this final rule we are not taking final action on updates to the GHG standards. Instead, we intend to consider potential changes to certain HD GHG Phase 2 standards as part of a subsequent rulemaking.

### B. Overview of the Final Regulatory Action

We are finalizing a program that will begin in MY 2027, which is the earliest year that these new criteria pollutant standards can begin to apply under CAA section 202(a)(3)(C).<sup>30</sup> The final NO<sub>x</sub> standards are a single-step program that reflect the greatest degree of emission reduction achievable starting in MY2027, giving appropriate consideration to costs and other factors. The final rule establishes not only new, much more stringent NO<sub>x</sub> standards compared to today's standards, but also requires lower NO<sub>x</sub> emissions over a much wider range of testing conditions both in the laboratory and when engines are operating on the road. Further, the final standards include longer useful life periods, as well as significant increases in the emissions-related warranty periods. The longer useful life and emissions warranty periods are particularly important for ensuring continued emissions control when the engines are operating on the road. These final standards will result in significant reductions in emissions of NO<sub>x</sub>, PM<sub>2.5</sub>, and other air pollutants across the country, which we project will meaningfully decrease ozone

<sup>25</sup> See Section VI for more information on projected inventory contributions from each operating mode or process, as well as discussion on the emissions impacts of tampering and mal-maintenance.

<sup>26</sup> Emission standards set under CAA section 202(a) apply to vehicles and engines "for their useful life." CAA section 202(d) directs EPA to prescribe regulations under which the useful life of vehicles and engines shall be determined, and for heavy-duty vehicles and engines establishes minimum values of 10 years or 100,000 miles, whichever occurs first, unless EPA determines that greater values are appropriate. CAA section 207(a) further requires manufacturers to provide emission-related warranty, and EPA set the current emission-related warranty periods for heavy-duty engines in 1983 (48 FR 52170, November 16, 1983). See Section I.D for more discussion on the statutory authority for the final rule.

<sup>27</sup> See Section IV for more discussion on the final useful life and warranty requirements.

<sup>28</sup> Of these comments, 1,860 were unique letters, many of which provided data and other detailed information for EPA to consider; the remaining comments were mass mailers sponsored by 30 different organizations, nearly all of which urged EPA to take action to reduce emissions from trucks or to adopt more stringent limits.

<sup>29</sup> U.S. EPA, "Control of Air Pollution from New Motor Vehicles: Heavy-Duty Engine and Vehicle Standards—Response to Comments", Docket EPA-HQ-OAR-2019-0055.

<sup>30</sup> Section 202(a)(3)(C) requires that standards under 202(a)(3)(A), such as the standards in this final rule, apply no earlier than 4 years after promulgation, and apply for no less than 3 model years. See Section I.D for additional discussion on the statutory authority for this action.

concentrations across the country. We expect the largest improvements in both ozone and PM<sub>2.5</sub> to occur in areas with the worst baseline air quality. In a supplemental demographic analysis, we also found that larger numbers of people of color are projected to reside in these areas with the worst baseline air quality.

The final standards and requirements are based on further consideration of the data included in the proposed rule, as well as additional supporting data from our own test programs, and consideration of the extensive public input EPA received in response to the proposed rule. As required by CAA section 202(a)(3), the final new numeric NO<sub>x</sub> standards will result in the greatest degree of emission reduction achievable for a national program starting in MY 2027 through the application of technology that the Administrator has determined will be available starting in MY 2027, after giving appropriate consideration to cost, energy, and safety factors associated with the application of such technology. The EPA proposal included two options for the NO<sub>x</sub> program. Proposed Option 1 was the more stringent option, and it included new standards and other program elements starting in MY 2027, which were further strengthened in MY 2031. Proposed Option 2 was the less stringent option, with new standards and requirements implemented fully in MY 2027. The final numeric NO<sub>x</sub> standards and testing requirements are largely consistent with the proposed Option 1 in MY 2027. The final numeric standards and regulatory useful life values will reduce NO<sub>x</sub> emissions not only when trucks are new, but throughout a longer period of their operational life under real-world conditions. For the smaller engine service-class categories, we are finalizing the longest regulatory useful life and emissions warranty periods proposed, and for the largest engines we are finalizing requirements for useful life and emissions aftertreatment durability demonstration that are significantly longer than required today.

As previously noted in this Section I, we received a large number and wide range of comments on the proposed rule. Several comments raised particularly significant issues related to some fundamental components of the proposed program, including the level of the numeric standards and feasibility of lower numeric standards combined with longer useful life periods. We briefly discuss these key issues in this Section I.B, with more detail in later sections in this preamble. The Response to Comments document provides our responses to the comments we received;

it is located in the docket for this rulemaking.

#### 1. Key Changes From the Proposal

##### i. Feasibility of More Stringent NO<sub>x</sub> Standards Combined With Much Longer Useful Life Periods

Many stakeholders commented on the proposed numeric NO<sub>x</sub> standards, and the feasibility of maintaining those numeric standards over the proposed useful life periods. Environmental organizations and other commenters, including suppliers to the heavy-duty industry, generally urged EPA to adopt the most stringent standards proposed, or to finalize even more stringent standards by fully aligning with the California Air Resources Board (CARB) Low NO<sub>x</sub> Omnibus program.<sup>31</sup> In contrast, most engine manufacturers, truck dealers, fleets, and other members of the heavy-duty industry stated that even the less stringent proposed numeric standards and useful life periods would be extremely challenging to meet, particularly for the largest heavy-duty engines. Some of these commenters provided data that they stated showed the potential for large impacts on the purchase price of a new truck if EPA were to finalize the most stringent proposed numeric standards and useful life periods for the largest heavy-duty engines.

As summarized in I.B.2 and detailed in preamble Section III, we are finalizing numeric NO<sub>x</sub> standards and useful life periods that are largely consistent with the most stringent proposed option for MY 2027. For all heavy-duty engine classes, the final numeric NO<sub>x</sub> standards for medium- and high-load engine operations match the most stringent standards proposed for MY 2027; for low-load operations we are finalizing the most stringent standard proposed for any model year (see I.B.1.ii for discussion).<sup>32</sup> For smaller heavy-duty engines (*i.e.*, light and medium heavy-duty engines CI and

SI heavy-duty engines), the numeric standards are combined with the longest useful life periods we proposed. The final numeric NO<sub>x</sub> emissions standards and useful life periods for smaller heavy-duty engines are based on further consideration of data included in the proposal from our engine demonstration programs that show the final NO<sub>x</sub> emissions standards are feasible at the final useful life periods applicable to these smaller heavy-duty engines. Our assessment of the data available at the time of proposal is further supported by our evaluation of additional information and public comments stating that the proposed standards are feasible for these smaller engine categories. For the largest heavy-duty engines (*i.e.*, heavy heavy-duty engines), the final numeric standards are combined with the longest useful life mileage that we proposed for MY 2027. The final useful life periods for the largest heavy-duty engines are 50 percent longer than today's useful life periods, which will play an important role in ensuring continued emissions control while the engines operate on the road.

After further consideration of the data included in the proposal, as well as information submitted by commenters and additional data we collected since the time of proposal, we are finalizing two updates from our proposed testing requirements in order to ensure the greatest degree of emission reduction achievable are met throughout the final useful life periods; these updates are tailored to the larger engine classes (medium and heavy heavy-duty engines), which have longer useful life periods and more rigorous duty-cycles compared to the smaller engine classes. First, we are finalizing a requirement for manufacturers to demonstrate before heavy heavy-duty engines are in-use that the emissions control technology is durable through a period of time longer than the final useful life mileage.<sup>33</sup> For these largest engines with the longest useful life mileages, the extended laboratory durability demonstration will better ensure the final standards will be met throughout the regulatory useful life

<sup>31</sup> EPA is reviewing a waiver request under CAA section 209(b) from California for the Omnibus rule. For more information on the California Air Resources Board Omnibus rule see, "Heavy-Duty Engine and Vehicle Omnibus Regulation and Associated Amendments," December 22, 2021. <https://ww2.arb.ca.gov/rulemaking/2020/hdomnibuslownox>. Last accessed September 21, 2022. See also "California State Motor Vehicle Pollution Control Standards and Nonroad Engine Pollution Control Standards; The "Omnibus" Low NO<sub>x</sub> Regulation; Request for Waivers of Preemption; Opportunity for Public Hearing and Public Comment" at 87 FR 35765 (June 13, 2022).

<sup>32</sup> As proposed, we are finalizing a new test procedure for heavy-duty CI engines to demonstrate emission control when the engine is operating under low-load and idle conditions; this new test procedure does not apply to heavy-duty SI engines (see Sections I.B.2 and III for additional discussion).

<sup>33</sup> Manufacturers of any size heavy-duty engine must demonstrate that the emission control technology is durable through a period equivalent to the useful life period of the engine, and may be subject to recall if EPA subsequently determines that properly maintained and used engines do not conform to our regulations over the useful life period (as specified in our regulations and consistent with CAA section 207). As outlined here, the extended laboratory durability demonstration in the final program will require manufacturers of the largest heavy-duty engines to demonstrate emission control durability for a longer period to better ensure that in-use engines will meet emission standards throughout the long regulatory useful life of these engines.

under real-world operations where conditions are more variable. Second, we are finalizing an interim compliance allowance that applies when EPA evaluates whether the heavy or medium heavy-duty engines are meeting the final standards after these engines are in use in the real world. When combined with the final useful life values, we believe the interim compliance allowance will address concerns raised in comments from manufacturers that the more stringent proposed MY 2027 standards would not be feasible to meet over the very long useful life periods of heavy heavy-duty engines, or under the challenging duty-cycles of medium heavy-duty engines. This interim, in-use compliance allowance is generally consistent with our past practice (for example, see 66 FR 5114, January 18, 2001); also consistent with past practice, the interim compliance allowance is included as an interim provision that we may reassess in the future through rulemaking based on the performance of emissions controls over the final useful life periods for medium and heavy heavy-duty engines. To set standards that result in the greatest emission reductions achievable for medium and heavy heavy-duty engines, we considered additional data that we and others collected since the time of the proposal; these data show the significant technical challenge of maintaining very low NO<sub>x</sub> emissions throughout very long useful life periods for heavy heavy-duty engines, and greater amounts of certain aging mechanisms over the long useful life periods of medium heavy-duty engines. In addition to these data, in setting these standards, we gave appropriate consideration to costs associated with the application of technology to achieve maximum emissions reductions in MY 2027 (*i.e.*, cost of compliance for manufacturers associated with the standards) and other factors. We determined that for heavy heavy-duty engines the combination of: (1) The most stringent MY 2027 standards proposed, (2) longer useful life periods compared to today's useful life periods, (3) targeted, interim compliance allowance approach to in-use compliance testing, and (4) the extended durability demonstration for emissions control technologies is appropriate, feasible, and consistent with our authority under the CAA to set technology-forcing NO<sub>x</sub> pollutant standards for heavy-duty engines for their useful life.<sup>34</sup> Similarly, for medium

heavy-duty engines we determined that the combination of the first three elements (*i.e.*, most stringent MY 2027 standards proposed, increase in useful life periods, and interim compliance allowance for in-use testing) is appropriate, feasible, and consistent with our CAA authority to set technology-forcing NO<sub>x</sub> pollutant standards for heavy-duty engines for their useful life.

#### ii. Test Procedures To Control Emissions Under a Broader Range of Engine Operations

Many commenters supported our proposal to update our test procedures to more accurately account for and control emissions across a broader range of engine operation, including in urban driving conditions and other operations that could impact communities already overburdened with pollution. Consistent with our proposal, we are finalizing several provisions to reduce emissions from a broader range of engine operating conditions. First, we are finalizing new standards for our existing test procedures to reduce emissions under medium- and high-load operations (*e.g.*, when trucks are traveling on the highway). Second, we are finalizing new standards and a corresponding new test procedure to measure emissions during low-load operations (*i.e.*, the low-load cycle, LLC). Third, we are finalizing new standards and updates to an existing test procedure to measure emissions over the broader range of operations that occur when heavy-duty engines are operating on the road (*i.e.*, off-cycle).<sup>35</sup>

advances in pollution control capability, considering costs and other statutory factors. See *National Petrochemical & Refiners Association v. EPA*, 287 F.3d 1130, 1136 (D.C. Cir. 2002) (explaining that EPA is authorized to adopt "technology-forcing" regulations under CAA section 202(a)(3)); *NRDC v. Thomas*, 805 F.2d 410, 428 n.30 (D.C. Cir. 1986) (explaining that such statutory language that "seek[s] to promote technological advances while also accounting for cost does not detract from their categorization as technology-forcing standards"); see also *Husqvarna AB v. EPA*, 254 F.3d 195 (D.C. Cir. 2001) (explaining that CAA sections 202 and 213 have similar language and are technology-forcing standards). In this context, the term "technology-forcing" has a specific legal meaning and is used to distinguish standards that may require manufacturers to develop new technologies (or significantly improve existing technologies) from standards that can be met using existing off-the-shelf technology alone. Technology-forcing standards such as those in this final rule do not require manufacturers to use specific technologies.

<sup>35</sup> Duty-cycle test procedures measure emissions while the engine is operating over precisely defined duty cycles in an emissions testing laboratory and provide very repeatable emission measurements. "Off-cycle" test procedures measure emissions while the engine is not operating on a specified duty cycle; this testing can be conducted while the engine is being driven on the road (*e.g.*, on a

The new, more stringent numeric standards for the existing laboratory-based test procedures that measure emissions during medium- and high-load operations will ensure significant emissions reductions from heavy-duty engines. Without this final rule, these medium- and high-load operations are projected to contribute the most to heavy-duty NO<sub>x</sub> emissions in 2045.

We are finalizing as proposed a new LLC test procedure, which will ensure demonstration of emission control under sustained low-load operations. After further consideration of data included in the proposal, as well as additional information from the comments summarized in this section, we are finalizing the most stringent numeric LLC standard proposed for any model year. As discussed in our proposal, data from our CI engine demonstration program showed that the lowest numeric NO<sub>x</sub> standard proposed would be feasible for the LLC throughout a useful life period similar to the useful life period we are finalizing for the largest heavy-duty engines. After further consideration of this data, and additional support from data collected since the time of proposal, we are finalizing the most stringent standard proposed for any model year.

We are finalizing new numeric standards and revisions to the proposed off-cycle test procedure. We proposed updates to the current off-cycle test procedure that included binning emissions measurements based on the type of operation the engine is performing when the measurement data is being collected. Specifically, we proposed that emissions data would be grouped into three bins, based on whether the engine was operating in idle (Bin 1), low-load (Bin 2), or medium-to-high load (Bin 3). Given the different operational profiles of each of the three bins, we proposed a separate standard for each bin. Based on further consideration of data included in the proposal, as well as additional support from our consideration of data provided by commenters, we are finalizing off-cycle standards for two bins, rather than three bins; correspondingly, we are finalizing a two-bin approach for grouping emissions data collected during off-cycle test procedures. Our evaluation of available information shows that two bins better represent the

package delivery route), or in an emission testing laboratory. Both duty-cycle and off-cycle testing are conducted pre-production (*e.g.*, for certification) or post-production to verify that the engine meets applicable duty-cycle or off-cycle emission standards throughout useful life (see Section III for more discussion).

<sup>34</sup> CAA section 202(a)(3)(A) is a technology-forcing provision and reflects Congress' intent that standards be based on projections of future

differences in engine operations that influence emissions (*e.g.*, exhaust temperature, catalyst efficiency) and ensure sufficient data is collected in each bin to allow for an accurate analysis of the data to determine if emissions comply with the standard for each bin. Preamble Section 0 further discusses the final off-cycle standards with additional detail in preamble Section III.

### iii. Lengthening Emissions-Related Warranty

EPA received general support from many commenters for the proposal to lengthen the emissions-related warranty beyond existing requirements. Some commenters expressed support for one of the proposed options, and one organization suggested a warranty period even longer than either proposed option. Several stakeholders also commented on the costs of lengthened warranty periods and potential economic impacts. For instance, one state commenter supported EPA's cost estimates and agreed that the higher initial cost will be offset by lower repair costs; further, the commenter expects the resale value of lengthened warranty will be maintained for subsequent owners. In contrast, stakeholders in the heavy-duty engine and truck industry (*e.g.*, engine and vehicle manufacturers, truck dealers, suppliers of emissions control technologies) commented that the proposed warranty periods would add costs to vehicles, and raised concerns about these cost impacts on first purchasers. Many commenters indicated that purchase price increases due to the longer warranty periods may delay emission reductions, stating that high costs could incentivize pre-buy and reduce fleet turnover from old technology.

After further consideration of data included in the proposal, and consideration of additional supporting information from the comments summarized in this Section I.B.1.iii, we are finalizing a single-step increase for new, longer warranty periods to begin in MY 2027. Several commenters recommended we pull ahead the longest proposed warranty periods to start in MY 2027. We agree with that approach for the smaller heavy-duty engine classes, and our final warranty mileages match the longest proposed warranty periods for these smaller engines (*i.e.*, Spark-ignition HDE, Light HDE, and Medium HDE). However, we are finalizing a different approach for the largest heavy-duty engines (*i.e.*, Heavy HDE). We are finalizing a warranty mileage that matches the MY 2027 step of the most stringent proposed option to

maximize the emission control assurance and to cover a percentage of the final useful life that is more consistent with the warranty periods of the smaller engine classes. The final emissions warranty periods are approximately two to four times longer than today's emissions warranty periods. The durations of the final emissions warranty periods balance two factors: First, the expected improvements in engine emission performance from longer emissions warranty periods due to increases in maintenance and lower rates of tampering with emissions controls (see preamble Section IV.B for more discussion); and second, the potential, particularly for the largest heavy-duty engines, for very large increases in purchase price due to much longer warranty periods to slow fleet turnover through increases in pre- and low-buy, and subsequently result in fewer emissions reductions. We are finalizing emissions warranty periods that in our evaluation will provide a significant increase in the emissions warranty coverage while avoiding large increases in the purchase price of a new truck.

### iv. Model Year 2027 Single-Step Program

Many stakeholders expressed support for a single-step program to implement new emissions standards and program requirements beginning in model year 2027, which is consistent with one of the proposed options. Stakeholders in the heavy-duty engine and truck industry, including suppliers of emissions controls technologies, truck dealers, and engine manufacturers, generally stated that a single-step program avoids technology disruptions and allows industry to focus on research and development for zero-emissions vehicle technologies for model years beyond 2027. Some of these commenters further noted that a two-step approach would result in gaps in available technology for some vehicle types and could exacerbate slower fleet turnover from pre- and low-buy associated with new standards. The trade association for truck dealers noted that a two-step approach would significantly compromise expected vehicle performance characteristics, including fuel economy. Other commenters also generally supported a single-step approach in order for the most stringent standards to begin as soon as possible, which would lead to larger emissions reductions earlier than a two-step approach. Several of these stakeholders noted the importance of early emissions reductions in

communities already overburdened with pollution.

The final NO<sub>x</sub> standards are a single-step program that reflect the greatest emission reductions achievable starting in MY 2027, giving appropriate consideration to costs and other factors. In this final rule, we are focused on achieving the greatest emission reductions achievable in the MY 2027 timeframe, and have applied our judgment in determining the appropriate standards for MY 2027 under our CAA authority for a national program. As the heavy-duty industry continues to transition to zero-emission technologies, EPA could consider additional criteria pollutant standards for model years beyond 2027 in future rules.

### v. Averaging, Banking, and Trading of NO<sub>x</sub> Emissions

The majority of stakeholders supported the proposed program to allow averaging, banking, and trading (ABT) of NO<sub>x</sub> emissions, although several suggested adjustments for EPA to consider in the final rule. Stakeholders provided additional input on several specific aspects of the proposed ABT program, including the proposed family emissions limit (FEL) caps, the proposed Early Adoption Incentives, and the proposed allowance for manufacturers to generate NO<sub>x</sub> emissions credits from Zero Emissions Vehicles (ZEVs). In this Section we briefly discuss stakeholder perspectives on these specific aspects of the proposed ABT program, as well as our approach for each in the final rule.

#### a. Family Emissions Limit Caps

A wide range of stakeholders urged EPA to finalize a lower FEL cap than proposed; there was broad agreement that the FEL cap in the final rule should be 100 mg/hp-hr or lower, with commenters citing various considerations, such as the magnitude of reduction between the current and proposed standards, as well as the desire to prevent competitive disruption.

After further consideration, including consideration of public comments, we are finalizing lower FEL caps than proposed. The FEL caps in the final rule are 65 mg/hp-hr for MY 2027 through 2030, and 50 mg/hp-hr for MY 2031 and later. Our rationale for the final FEL caps includes two main factors. First, we agree with commenters that the difference between the current standard (approximately 200 mg/hp-hr) and the standards we are finalizing for MY 2027 and later suggests that FEL caps lower than the current standard are



appropriate to ensure that available emissions control technologies are adopted. This is consistent with our past practice when issuing rules for heavy-duty onroad engines or nonroad engines in which there was a substantial (*e.g.*, greater than 50 percent) difference between the numeric levels of the existing and new standards (69 FR 38997, June 29, 2004; 66 FR 5111, January 18, 2001). Specifically, by finalizing FEL caps below the current standards, we are ensuring that the vast majority of new engines introduced into commerce include updated emissions control technologies compared to the emissions control technologies manufacturers use to meet the current standards.<sup>36</sup>

Second, finalizing FEL caps below the current standard is consistent with comments from manufacturers stating that a FEL cap of 100 mg/hp-hr or between 50 and 100 mg/hp-hr would help to prevent competitive disruptions (*i.e.*, require all manufacturers to make improvements in their emissions control technologies).

The FEL caps for the final rule have been set at a level to ensure sizeable emission reductions from the current 2010 standards, while providing manufacturers with flexibility in meeting the final standards. When combined with the other restrictions in the final ABT program (*i.e.*, credit life, averaging sets, expiration of existing credit balances), we determined the final FEL caps of 65 mg/hp-hr in MYs 2027 through 2030, and 50 mg/hp-hr in MY 2031 and later avoid potential adverse effects on the emissions reductions expected from the final program.

#### b. Encouraging Early Adoption of New Emissions Controls Technologies

Several stakeholders provided general comments on the proposed Early Adoption Incentive program, which included emissions credit multipliers of 1.5 or 2.0 for meeting all proposed requirements prior to the applicable model year. Although many of the stakeholders in the heavy-duty engine industry generally supported incentives

such as emissions credit multipliers to encourage early investments in emissions reductions technology; other industry stakeholders were concerned that the multipliers would incentivize some technologies (*e.g.*, hybrid powertrains, natural gas engines) over others (*e.g.*, battery-electric vehicles). Environmental organizations and other commenters were concerned that the emissions credit multipliers would result in an excess of credits that would undermine some of the benefits of the rule.

After consideration of public comments, EPA is not finalizing the proposed Early Adoption Incentives program, and in turn we are not including emissions credit multipliers in the final program. Rather, we are finalizing an updated version of the proposed transitional credit program under the ABT program. As described in preamble Section IV.G.7, the transitional credit program that we are finalizing provides four pathways to generate straight NO<sub>x</sub> emissions credits (*i.e.*, no credit multipliers) in order to encourage the early introduction engines with NO<sub>x</sub>-reducing technology.

#### c. Heavy-Duty Zero Emissions Vehicles and NO<sub>x</sub> Emissions Credits

Numerous stakeholders provided feedback on EPA's proposal to allow manufacturers to generate NO<sub>x</sub> emissions credits from ZEVs. Environmental organizations and other commenters, as well as suppliers of heavy-duty engine and vehicle components, broadly oppose allowing manufacturers to generate NO<sub>x</sub> emissions credits from ZEVs. These stakeholders present several lines of argument, including the potential for: (1) Substantial impacts on the emissions reductions expected from the proposed rule, which could also result in disproportionate impacts in disadvantaged communities already overburdened with pollution; and (2) higher emissions from internal combustion engines, rather than further incentives for additional ZEVs (further noting that other State and Federal actions are providing more meaningful and less environmentally costly HD ZEV incentives). In contrast, heavy-duty engine and vehicle manufacturers generally support allowing manufacturers to generate these credits. These stakeholders also provided several lines of argument, including: (1) The potential for ZEVs to help meet emissions reductions and air quality goals; (2) an assertion that ZEV NO<sub>x</sub> credits are essential to the achievability of the standards for some manufacturers; and (3) ZEV NO<sub>x</sub> credits

allow manufacturers to manage investments across different products that may ultimately result in increased ZEV deployment.

After further consideration, including consideration of public comments, we are not finalizing the allowance for manufacturers to generate NO<sub>x</sub> emissions credits from heavy-duty ZEVs. Our decision is based on two primary considerations. First, the standards in the final rule are technology-forcing, yet achievable for MY 2027 and later internal combustion engines without this flexibility. Second, because the final standards are not based on projected utilization of ZEV technology, and because we believe there will be increased penetration of ZEVs in the heavy-duty fleet by MY 2027 and later,<sup>37</sup> we are concerned that allowing ZEVs to generate NO<sub>x</sub> emissions credits would result in fewer emissions reductions than intended from this rule. For example, by allowing manufacturers to generate ZEV NO<sub>x</sub> credits, EPA would be allowing higher emissions (through internal combustion engines using credits to emit up to the FEL cap) in MY 2027 and later, without requiring commensurate emissions reductions (through additional ZEVs beyond those already entering the market without this rule). This erosion of emissions benefits could have particularly adverse impacts in communities already overburdened by pollution. In addition, we continue to believe that testing requirements to ensure continued battery and fuel cell performance over the useful life of a ZEV may be important to ensure the zero-emissions tailpipe performance for which they are generating NO<sub>x</sub> credits; however, after further consideration, including consideration of public comments, we believe it is appropriate to take additional time to work with industry and other stakeholders on any test procedures and other specifications for ZEV battery and fuel cell performance over the useful life period of the ZEV.

## 2. Summary of the Key Provisions in the Regulatory Action

### i. Controlling Criteria Pollutant Emissions Under a Broader Range of Operating Conditions

The final rule provisions will reduce emissions from heavy-duty engines

<sup>37</sup> For example, the recently passed Inflation Reduction Act (IRA) has many incentives for promoting zero-emission vehicles, see Sections 13403 (Qualified Clean Vehicles), 13404 (Alternative Fuel Refueling Property Credit), 60101 (Clean Heavy-Duty Vehicles), 60102 (Grants to Reduce Air Pollution at Ports), and 70002 (United States Postal Service Clean Fleets) of H. R. 5376.

<sup>36</sup> As discussed in Section IV.G.9, we are finalizing an allowance for manufacturers to continue to produce a small number (5 percent of production volume) of engines that meet the current standards for a few model years (*i.e.*, through MY 2030); thus, the vast majority of, but not all, new engines will need to include updated emissions control technologies compared to those used to meet today's standards until MY 2031, when all engines will need updated emissions control technologies to comply with the final standards or use credits up to the FEL cap. See Section IV.G.9 for details on our approach and rationale for including this allowance in the final rule.

under a range of operating conditions through revisions to our emissions standards and test procedures. These revisions will apply to both laboratory-based standards and test procedures for both heavy-duty CI and SI engines, as well as the off-cycle standards and test procedures for heavy-duty CI engines. These final provisions are outlined immediately below and detailed in Section III.

a. Final Laboratory Standards and Test Procedures

For heavy-duty CI engines, we are finalizing new standards for laboratory-based tests using the current duty cycles, the transient Federal Test Procedure (FTP) and the steady-state Supplemental Emission Test (SET) procedure. These existing test procedures require CI engine manufacturers to demonstrate the effectiveness of emission controls when the engine is transitioning from low-to-high loads or operating under sustained high load, but do not include demonstration of emission control under sustained low-load operations. As proposed, we are finalizing a new, laboratory-based LLC test procedure for heavy-duty CI engines to demonstrate emission control when the engine is operating under low-load and idle conditions. The addition of the LLC will help ensure lower NO<sub>x</sub> emissions in

urban areas and other locations where heavy-duty vehicles operate in stop-and-go traffic or other low-load conditions. As stated in Section I.B.1, we are finalizing the most stringent standard proposed for any model year for low-load operations based on further evaluation of data included in the proposal, and supported by information received during the comment period. We are also finalizing as proposed the option for manufacturers to test hybrid engines and powertrains together using the final powertrain test procedure.

For heavy-duty SI engines, we are finalizing new standards for laboratory-based testing using the current FTP duty cycle, as well as updates to the current engine mapping procedure to ensure the engines achieve the highest torque level possible during testing. We are also finalizing the proposed addition of the SET duty-cycle test procedure to the heavy-duty SI laboratory demonstrations; it is currently only required for heavy-duty CI engines. Heavy-duty SI engines are increasingly used in larger heavy-duty vehicles, which makes it more likely for these engines to be used in higher-load operations covered by the SET.

Our final NO<sub>x</sub> emission standards for all defined duty cycles for heavy-duty CI and SI engines are detailed in Table I-1. As shown, the final NO<sub>x</sub> standards will be implemented with a single step

in MY 2027 and reflect the greatest emission reductions achievable starting in MY 2027, giving appropriate consideration to costs and other factors. As discussed in I.B.1.i, for the largest heavy-duty engines we are finalizing two updates to our testing requirements to ensure the greatest emissions reductions technically achievable are met throughout the final useful life periods of the largest heavy-duty engines: (1) A requirement for manufacturers to demonstrate before heavy heavy-duty engines are in-use that the emissions control technology are durable through a period of time longer than the final useful mileage, and (2) a compliance allowance that applies when EPA evaluates whether medium or heavy heavy-duty engines are meeting the final standards after these engines are in-use in the real world. We requested comment on an interim compliance allowance, and it is consistent with our past practice (for example, see 66 FR 5114, January 18, 2001); the interim compliance allowance is shown in the final column of Table I-1. See Section III for more discussion on feasibility of the final standards. Consistent with our existing, MY 2010 standards for criteria pollutants, the final standards, presented in Table 1, are numerically identical for SI and CI engines.<sup>38</sup>

TABLE I-1—FINAL NO<sub>x</sub> EMISSION STANDARDS FOR HEAVY-DUTY CI AND SI ENGINES ON SPECIFIC DUTY CYCLES [milligrams/horsepower-hour (mg/hp-hr)]

	Current	Model years 2027 and later	
	All HD engines	Spark ignition HDE, light HDE, medium HDE, and heavy HDE	Medium and heavy HDE with interim in-use compliance allowance
Federal Test Procedure (transient mid/high load conditions) .....	200	35	50
Supplemental Emission Test (steady-state conditions) .....	200	35	50
Low Load Cycle (low-load conditions) .....	N/A	50	65

b. Final On-the-Road Standards and Test Procedures

In addition to demonstrating emission control over defined duty cycles tested in a laboratory, heavy-duty CI engines must be able to demonstrate emission control over operations experienced while engines are in use on the road in the real world (*i.e.*, “off-cycle” testing).<sup>39</sup> We are finalizing with

revisions the proposed updates to the procedure for off-cycle testing, such that data collected during a wider range of operating conditions will be valid, and therefore subject to emission standards.

Similar to the current approach, emission measurements collected during off-cycle testing will be collected on a second-by-second basis. As proposed, we are finalizing that the emissions data will be grouped into 300-

second windows of operation. Each 300-second window will then be binned based on the type of operation that the engine performs during that 300-second period. Specifically, the average power of the engine during each 300-second window will determine whether the emissions during that window are binned as idle (Bin 1), or non-idle (Bin 2).<sup>40</sup>

<sup>38</sup> See Section III for our final PM, HC, and CO standards.

<sup>39</sup> As discussed in Section III, “off-cycle” testing measures emissions while the engine is not operating on a specified duty cycle; this testing can

be conducted while the engine is being driven on the road (*e.g.*, on a package delivery route), or in an emission testing laboratory.

<sup>40</sup> Due to the challenges of measuring engine power directly on in-use vehicles, we are finalizing

as proposed the use of the CO<sub>2</sub> emission rate (grams per second) as a surrogate for engine power; further, we are finalizing as proposed to normalize CO<sub>2</sub> emission rates relative to the nominal maximum CO<sub>2</sub> rate of the engine (*e.g.*, when an engine with

Our final, two-bin approach covers a wide range of operations that occur in the real world—significantly more in-use operation than today’s requirements. Bin 1 includes extended idle and other very low-load operations, where engine exhaust temperatures may drop below the optimal temperature where SCR-based aftertreatment works best. Bin 2 includes a large fraction of urban driving conditions, during which engine exhaust temperatures are generally moderate, as well as higher-power operations, such as on-highway driving, that typically results in higher

exhaust temperatures and high catalyst efficiencies.<sup>41</sup> Given the different operational profiles of each of these two bins, we are finalizing, as proposed, a separate standard for each bin. As proposed, the final structure follows that of our current not-to-exceed (NTE) off-cycle standards where testing is conducted while the engine operates on the road conducting its normal driving patterns, however, the final standards apply over a much broader range of engine operation.

Table I–2 presents our final off-cycle standards for NO<sub>x</sub> emissions from

heavy-duty CI engines. As discussed in I.B.1.i, for the medium and heavy heavy-duty engines we are also finalizing an interim compliance allowance that applies to non-idle (Bin 2) off-cycle standard after the engines are in-use. This interim compliance allowance is consistent with our past practice (for example, see 66 FR 5114, January 18, 2001) and is shown in the final column of Table I–2. See Section III for details on the final off-cycle standards for other pollutants.

TABLE I–2—FINAL OFF-CYCLE NO<sub>x</sub> STANDARDS FOR HEAVY-DUTY CI ENGINES<sup>a</sup>

	Model years 2027 and later	
	Light HDE, medium HDE, heavy HDE	Medium HDE and heavy HDE with in-use compliance allowance
Bin 1: Idle (g/hr) .....	10.0	<sup>b</sup> 10.0
Bin 2: Low/medium/high load (mg/hp-hr) .....	58	73

<sup>a</sup> The standards reflected in Table I–2 are applicable at 25 °C and above; at lower temperatures the numerical off-cycle Bin 1 and Bin 2 standards for NO<sub>x</sub> adjust as a function of ambient air temperature (see preamble Section III.C for details).

<sup>b</sup> The interim compliance allowance we are finalizing for medium and heavy heavy-duty engines does not apply to the Bin 1 (Idle) off-cycle standard (see preamble Section III for details).

In addition to the final standards for the defined duty cycle and off-cycle test procedures, the final standards include several other provisions for controlling emissions from specific operations in CI or SI engines. First, we are finalizing, as proposed, to allow CI engine manufacturers to voluntarily certify to idle standards using a new idle test procedure that is based on an existing California Air Resources Board (CARB) procedure.<sup>42</sup>

We are also finalizing two options for manufacturers to control engine crankcase emissions. Specifically, manufacturers will be required to either: (1) As proposed, close the crankcase, or (2) measure and account for crankcase emissions using an updated version of the current requirements for an open crankcase. We believe that either will ensure that the total emissions are accounted for during certification testing and throughout the engine operation during useful life. See Section III.B for more discussion on both the final idle and crankcase provisions.

For heavy-duty SI, we are finalizing as proposed a new refueling emission

standard for incomplete vehicles above 14,000 lb GVWR starting in MY 2027.<sup>43</sup> The final refueling standard is based on the current refueling standard that applies to complete heavy-duty gasoline-fueled vehicles. Consistent with the current evaporative emission standards that apply for these same vehicles, we are finalizing a requirement that manufacturers can use an engineering analysis to demonstrate that they meet our final refueling standard. We are also adopting an optional alternative phase-in compliance pathway that manufacturers can opt into in lieu of being subject to this implementation date for all incomplete heavy-duty vehicles above 14,000 pounds GVWR (see Section III.E for details).

ii. Ensuring Standards Are Met Over a Greater Portion of an Engine’s Operational Life

In addition to reducing emissions under a broad range of engine operating conditions, the final program also includes provisions to ensure emissions standards are met over a greater portion

of an engine’s operational life. These final provisions include: (1) Lengthened regulatory useful life periods for heavy-duty engines, (2) revised requirement for the largest heavy-duty engines to demonstrate that the emissions control technology is durable through a period of time longer than the final useful life mileage, (3) updated methods to more accurately and efficiently demonstrate the durability of emissions controls, (4) lengthened emission warranty periods, and (5) increased assurance that emission controls will be maintained properly through more of the service life of heavy-duty engines. Each of these final provisions is outlined immediately below and detailed in Section IV.

a. Final Useful Life Periods

Consistent with the proposal, the final useful life periods will cover a significant portion of the engine’s operational life.<sup>44</sup> The longer useful life periods, in combination with the durability demonstration requirements we are finalizing in this rule, are expected to lead manufacturers to further improve the durability of their

a maximum CO<sub>2</sub> emission rate of 50 g/sec emits at a rate of 10 g/sec, its normalized CO<sub>2</sub> emission rate is 20 percent).

<sup>41</sup> Because the final approach considers time-averaged power, either of the bins could include some idle operation and any of the bins could include some high-power operation.

<sup>42</sup> 13 CCR 1956.8 (a)(6)(C)—Optional NO<sub>x</sub> idling emission standard.

<sup>43</sup> Some vehicle manufacturers sell their engines or “incomplete vehicles” (*i.e.*, chassis that include their engines, the frame, and a transmission) to body builders who design and assemble the final vehicle.

<sup>44</sup> We consider operational life to be the average mileage at rebuild for CI engines and the average mileage at replacement for SI engines (see preamble Section IV.A for details).

emission-related components. After additional consideration of data included in the proposal, as well as additional data provided in public comments, we are modifying our proposed useful life periods to account for the combined effect of useful life and the final numeric standards on the overall stringency and emissions reductions of the program (see Section IV.A for additional details).

For smaller heavy-duty engines (*i.e.*, Spark-ignition HDE, Light HDE, and

Medium HDE) we are finalizing the longest useful life periods proposed (*i.e.*, MY 2031 step of proposed option 1), to apply starting in MY 2027. The final useful life mileage for Heavy HDE, which has a distinctly longer operational life than the smaller engine classes, is approximately 50 percent longer than today's useful life mileage for these engines and matches the longest useful life we proposed for MY 2027. Our final useful life periods for all

heavy-duty engine classes are presented in Table I–3. We are also increasing the years-based useful life from the current 10 years to values that vary by engine class and match the respective proposed options. After considering comments, we are also adding hours-based useful life values to all engine categories based on a 20 mile per hour speed threshold and the corresponding final mileage values.<sup>45</sup>

TABLE I–3—CURRENT AND FINAL USEFUL LIFE PERIODS FOR HEAVY-DUTY CI AND SI ENGINES

Primary intended service class	Current			MY 2027 and later		
	Miles	Years	Hours	Miles	Years	Hours
Spark-ignition HDE <sup>a</sup>	110,000	10	.....	200,000	15	10,000
Light HDE <sup>a</sup>	110,000	10	.....	270,000	15	13,000
Medium HDE	185,000	10	.....	350,000	12	17,000
Heavy HDE <sup>b</sup>	435,000	10	22,000	650,000	11	32,000

<sup>a</sup> Current useful life period for Spark-ignition HDE and Light HDE for GHG emission standards is 15 years or 150,000 miles; we are not revising these useful life periods in this final rule. See 40 CFR 1036.108(d).

<sup>b</sup> As discussed in Section I.B.2.ii.c, we are finalizing a requirement for manufacturers to demonstrate at the time of certification that the emissions controls on these largest heavy-duty engines are durable through the equivalent of 750,000 miles.

b. Extended Laboratory Demonstration of Emissions Control Durability for the Largest Heavy-Duty Engines

As discussed in Section I.B.1.i, for the largest heavy-duty engines we are finalizing two updates to our proposed testing requirements in order to ensure the greatest emissions reductions technically achievable are met throughout the final useful life periods of these engines. One of the approaches (an in-use interim compliance allowance for medium and heavy heavy-duty engines) was noted in Section I.B.2.i; here we focus on the requirement for manufacturers to demonstrate before the largest heavy-duty engines are in use that the emissions control technology is durable through a period of time longer than the final useful mileage. Specifically, we are finalizing a requirement for manufacturers to demonstrate before the largest heavy-duty engines are in use that the emissions controls on these engines are durable (*e.g.*, capable of controlling NO<sub>x</sub> emissions over the FTP duty-cycle at a level of 35 mg/hp-hr) through the equivalent of 750,000 miles. The extended durability demonstration in a laboratory environment will better ensure the final standards will be met throughout the longer final regulatory

useful life mileage of 650,000 miles when these engines are operating in the real world where conditions are more variable.<sup>46</sup> As discussed immediately below in Section I.B.2.ii.c, we are also finalizing provisions to improve the accuracy and efficiency of emissions control durability demonstrations for all heavy-duty engine classes.

c. Final Durability Demonstration

EPA regulations require manufacturers to include durability demonstration data as part of an application for certification of an engine family. Manufacturers typically complete this demonstration by following regulatory procedures to calculate a deterioration factor (DF). The final useful life periods outlined in Table I–4 will require manufacturers to extend their durability demonstrations to show that the engines will meet applicable emission standards throughout the lengthened useful life.

To address the need for accurate and efficient emission durability demonstration methods, EPA worked with manufacturers and CARB to address this concern through guidance for MY 2020 and later engines.<sup>47</sup> Consistent with the recent guidance, we proposed three methods for determining

DFs. We are finalizing two of the three proposed methods; we are not finalizing the option to perform a fuel-based accelerated DF determination, noting that it has been shown to underestimate emission control system deterioration. The two methods we are finalizing include: (1) Allowing manufacturers to continue the current practice of determining DFs based on engine dynamometer-based aging of the complete engine and aftertreatment system out to regulatory useful life, and (2) a new option to bench-age the aftertreatment system at an accelerated rate to limit the burden of generating a DF over the final lengthened useful life periods. If manufacturers choose the second option (accelerated bench-aging of the aftertreatment system), then they may also choose to use an accelerated aging test procedure that we are codifying in this final rule; the test procedure is, based on a test program that we introduced in the proposal to evaluate a rapid-aging protocol for diesel catalysts. We are also finalizing with revisions two of the three proposed DF verification options to confirm the accuracy of the DF values submitted by manufacturers for certification. After further consideration of data included in the proposal, as well as supported by

<sup>45</sup> As noted in this I.B.2, we are finalizing, as proposed, refueling standards for certain HD SI engines that apply for a useful life of 15 years or 150,000 miles. See 40 CFR 1037.103(f) and preamble Section IV.A for more details.

<sup>46</sup> Once these engines are in use, EPA can require manufacturers to submit test data, or can conduct our own testing, to verify that the emissions control technologies continue to control emissions through the 650,000 mile useful life period (or the equivalent hours or years requirements as applicable).

<sup>47</sup> U.S. EPA. "Guidance on Deterioration Factor Validation Methods for Heavy-Duty Diesel Highway Engines and Nonroad Diesel Engines equipped with SCR." CD–2020–19 (HD Highway and Nonroad). November 17, 2020.

information provided in public comments, we are finalizing that, upon EPA request, manufacturers would be required to provide confirmation of the DF accuracy through one of two options.

d. Final Emission-Related Warranty Periods

We are updating and significantly strengthening the emission-related warranty periods, for model year 2027 and later heavy-duty engines.<sup>48</sup> We are finalizing most of the emission-related warranty provisions of 40 CFR 1036.120 as proposed. Following our approach for useful life, we are revising the proposed warranty periods for each primary intended service class to reflect the difference in average operational life of each class and in consideration of the information provided by commenters (see preamble Section IV and the Response to Comments document for details).

EPA’s current emissions-related warranty periods for heavy-duty engines range from 22 percent to 54 percent of the current regulatory useful life. Notably, these percent values have decreased over time given that the warranty periods have not changed since 1983 even as the useful life periods were lengthened.<sup>49</sup> The revised warranty periods are expected to result in better maintenance, including maintenance of emission-related components, and less tampering, which would help to ensure the benefits of the emission controls in-use. In addition, longer regulatory warranty periods may lead engine manufacturers to simplify repair processes and make them more aware of system defects that need to be tracked and reported to EPA.

Our final emission-related warranty periods for heavy-duty engines are presented in Table I–4. The final warranty mileages that apply starting in MY 2027 for Spark-ignition HDE, Light

HDE, and Medium HDE match the longest warranty mileages proposed (*i.e.*, MY 2031 step of proposed Option 1) for these primary intended service classes. For Heavy HDE, which has a distinctly longer operational life, the final warranty mileage matches the longest warranty mileage proposed to apply in MY 2027 (*i.e.*, MY 2027 step of proposed Option 1), and is more than four times longer than today’s warranty mileage for these engines. We are also increasing the years-based warranty from the current 5 years to 10 years for all engine classes. After considering comments, we are also adding hours-based warranty values to all primary intended service classes based on a 20 mile per hour speed threshold and the corresponding final mileage values. Consistent with current warranty provisions, the warranty period would be whichever warranty value (*i.e.*, mileage, hours, or years) occurs first.

TABLE I–4—CURRENT AND FINAL EMISSION-RELATED WARRANTY PERIODS FOR HEAVY-DUTY CI AND SI ENGINES CRITERIA POLLUTANT STANDARDS

Primary intended service class	Current			Model year 2027 and later		
	Mileage	Years	Hours	Mileage	Years	Hours
Spark-Ignition HDE .....	50,000	5	.....	160,000	10	8,000
Light HDE .....	50,000	5	.....	210,000	10	10,000
Medium HDE .....	100,000	5	.....	280,000	10	14,000
Heavy HDE .....	100,000	5	.....	450,000	10	22,000

e. Provisions To Ensure Long-Term Emissions Performance

We proposed several approaches for an enhanced, comprehensive strategy to increase the likelihood that emission controls will be maintained properly through more of the operational life of heavy-duty engines, including beyond their useful life periods. These approaches include updated maintenance provisions, revised requirements for the owner’s manual and emissions label, codified engine derates or “inducements” regulations, and updated onboard diagnostics (OBD) regulations.

Our final updates to maintenance provisions include defining the type of maintenance manufacturers may choose to recommend to owners in maintenance instructions, updating minimum maintenance intervals for certain critical emission-related components, and outlining specific

requirements for maintenance instructions provided in the owner’s manual.

We are finalizing changes to the owner’s manual and emissions label requirements to ensure access to certain maintenance information and improve serviceability. We expect this additional maintenance information to improve factors that contribute to mal-maintenance, which would result in better service experiences for independent repair technicians, specialized repair technicians, owners who repair their own equipment, and possibly vehicle inspection and maintenance technicians. We also believe improving owner experiences with operating and maintaining heavy-duty engines can reduce the likelihood of tampering.

In addition, we are adopting inducement regulations that are an update to and replace existing guidance

regarding recommended methods for manufacturers to reduce engine performance to induce operators to maintain appropriate levels of high-quality diesel emission fluid (DEF) in their SCR-based aftertreatment systems and discourage tampering with such systems. See Section IV.D for details on the principles we followed to develop multi-step derate schedules that are tailored to different operating characteristics, as well as changes in the final rule inducement regulations from the proposal.

We are also finalizing updated OBD regulations both to better address newer diagnostic methods and available technologies, and to streamline provisions where possible. We are incorporating by reference the current CARB OBD regulations, updated in 2019, as proposed.<sup>50</sup> Specifically, manufacturers must comply with OBD requirements as referenced in the CARB

<sup>48</sup> Components installed to control only criteria pollutant emissions or both greenhouse gas (*i.e.*, CO<sub>2</sub>, N<sub>2</sub>O, and CH<sub>4</sub>) and criteria pollutant emissions would be subject to the final warranty periods of 40 CFR 1036.120. See 40 CFR 1036.150(w).

<sup>49</sup> The useful life for heavy heavy-duty engines was increased from 290,000 miles to 435,000 miles for 2004 and later model years (62 FR 54694, October 21, 1997).

<sup>50</sup> CARB’s 2019 Heavy-duty OBD Final Regulation Order was approved and became effective October

3, 2019. Title 13, California Code of Regulations sections 1968.2, 1968.5, 1971.1, and 1971.5, available at <https://ww2.arb.ca.gov/rulemaking/2018/heavy-duty-board-diagnostic-system-requirements-2018>.

OBD regulations starting in model year 2027, with optional compliance based on the CARB OBD regulations for earlier model years. After considering comments, many of which included specific technical information and requests for clarification, we are finalizing certain provisions with revisions from proposal and postponing others for consideration in a future rulemaking (see Section IV.C for details).

### iii. Averaging, Banking, and Trading of NO<sub>x</sub> Emissions Credits

In addition the key program provisions, EPA is finalizing an averaging, banking, and trading (ABT) program for heavy-duty engines that provides manufacturers with flexibility in their product planning while encouraging the early introduction of emissions control technologies and maintaining the expected emissions reductions from the program. Several core aspects of the final ABT program are consistent with the proposal, but the final ABT program also includes several updates after consideration of public comments. In particular, EPA requested comment on and agrees with commenters that a lower family emission limit (FEL) cap than proposed is appropriate for the final rule. Further, after consideration of public comments, EPA is choosing not to finalize at this time the proposed Early Adoption Incentives program, and in turn we are not including emissions credit multipliers in the final program. Rather, we are finalizing an updated version of the proposed transitional credit program under the ABT program. The revised transitional credit program that we are finalizing provides four pathways to generate NO<sub>x</sub> emissions credits in MYs 2022 through 2026 that are valued based on the extent to which the engines generating credits comply with the requirements we are finalizing for MY 2027 and later (e.g., credits discounted at a rate of 40 percent for engines meeting a lower numeric standard but none of the other MY 2027 and later requirements). Specifically, the four transitional credit pathways in the final rule are: (1) In MY 2026, for heavy heavy-duty or medium heavy-duty engine service classes, certify all engines in the manufacturer's respective service class to a FEL of 50 mg/hp-hr or less and meet all other EPA requirements for MYs 2027 and later to generate undiscounted credits that have additional flexibilities for use in MYs 2027 and later (2026 Service Class Pull Ahead Credits); (2) starting in MY 2024, certify one or more engine family(ies) to a FEL below the current MY 2010

emissions standards and meet all other EPA requirements for MYs 2027 and later to generate undiscounted credits based on the longer UL periods included in the 2027 and later program (Full Credits); (3) starting in MY 2024, certify one or more engine family(ies) to a FEL below the current MY 2010 emissions standards and several of the key requirements for MYs 2027 and later, while meeting the current useful life and warranty requirements to generate undiscounted credits based on the shorter UL period (Partial Credits); (4) starting in MY 2022, certify one or more engine family(ies) to a FEL below the current MY 2010 emissions standards, while complying with all other MY2010 requirements, to generate discounted credits (Discounted Credits). We note that the transitional credit and main ABT program we are finalizing does not allow engines certified to state standards that are different than the Federal EPA standards to generate Federal EPA credits.

In addition, we are finalizing an optional production volume allowance for MYs 2027 through 2029 that is consistent with our request for comment in the proposal but different in several key aspects, including a requirement for manufacturers to use NO<sub>x</sub> emissions credits to certify heavy heavy-duty engines compliant with MY 2010 requirements in MYs 2027 through 2029. Finally, we have decided not to finalize an allowance for manufacturers to generate NO<sub>x</sub> emissions credits from heavy-duty ZEVs (see Section IV.G for details on the final ABT program).

### iv. Migration From 40 CFR Part 86, Subpart A

Heavy-duty criteria pollutant regulations were originally codified into 40 CFR part 86, subpart A, in the 1980s. As discussed in the proposal, this rulemaking provides an opportunity to clarify and improve the wording of our existing heavy-duty criteria pollutant regulations in plain language and migrate them to 40 CFR part 1036.<sup>51</sup> Part 1036, which was created for the Phase 1 GHG program, provides a consistent, updated format for our heavy-duty regulations, with improved organization. In general, this migration is not intended to change the compliance program specified in part

86, except as specifically stated in this final rulemaking. See our summary of the migration in Section III.A. The final provisions of part 1036 will generally apply for model years 2027 and later, unless noted, and manufacturers will continue to use part 86 in the interim.

### v. Technical Amendments to Regulatory Provisions for Mobile Source Sectors

EPA has promulgated emission standards for highway and nonroad engines, vehicles, and equipment. Section XI of this final rule describes several amendments to correct, clarify, and streamline a wide range of regulatory provisions for many of those different types of engines, vehicles, and equipment. Section XI.A includes technical amendments to compliance provisions that apply broadly across EPA's emission control programs to multiple industry sectors, including light-duty vehicles, light-duty trucks, marine diesel engines, locomotives, and various other types of nonroad engines, vehicles, and equipment. Some of those amendments are for broadly applicable testing and compliance provisions in 40 CFR parts 1065, 1066, and 1068. Other cross-sector issues involve making the same or similar changes in multiple standard-setting parts for individual industry sectors. The rest of Section XI describes amendments we are finalizing that apply uniquely for individual industry sectors. Except as specifically identified in this rulemaking, EPA did not reopen any of the underlying provisions across these standard setting parts.

We are finalizing amendments in two areas of note for the general compliance provisions in 40 CFR part 1068. First, we are finalizing, with updates from proposal, a comprehensive approach for making confidentiality determinations related to compliance information that companies submit to or is collected by EPA. These provisions apply for highway, nonroad, and stationary engine, vehicle, and equipment programs, as well as aircraft and portable fuel containers.

Second, we are finalizing, with updates from proposal, provisions that include clarifying text to establish what qualifies as an adjustable parameter and to identify the practically adjustable range for those adjustable parameters. The adjustable-parameter provisions in the final rule also include specific provisions related to electronic controls that aim to deter tampering.

<sup>51</sup> We are also adding and amending some provisions in parts 1065 and 1068 as part of the migration from part 86 for heavy-duty highway engines; these provisions in part 1065 and 1068 will apply to other sectors that are already subject to part 1065 and 1068. Additionally, some current vehicle provisions in part 1037 refer to part 86 and, as proposed, the final rule updates those references in part 1037 as needed.

C. Impacts of the Standards

1. Projected Emission Reductions and Air Quality Improvements

Our analysis of the estimated emission reductions, air quality improvements, costs, and monetized benefits of the final rule is outlined in this section and detailed in Sections V through X. The final standards, which are described in detail in Sections III and IV, are expected to reduce emissions from highway heavy-duty engines in several ways. We project the final emission standards for heavy-duty CI engines will reduce tailpipe emissions of NO<sub>x</sub>; the combination of the final low-load test cycle and off-cycle test procedure for CI engines will help to ensure that the reductions in tailpipe emissions are achieved in-use, not only under high-speed, on-highway conditions, but also under low-load and idle conditions. We also project reduced tailpipe emissions of NO<sub>x</sub> from the final emission standards for heavy-duty SI engines, as well as reductions of CO, PM, VOCs, and associated air toxics, particularly under cold-start and high-load operating conditions. The final emissions warranty and regulatory useful life requirements for heavy-duty CI and SI engines will also help maintain emissions controls of all pollutants beyond the existing useful life periods, which will result in additional emissions reductions of all pollutants from both CI and SI engines, including primary exhaust PM<sub>2.5</sub>. The onboard refueling vapor recovery requirements for heavy-duty SI engines will reduce VOCs and associated air toxics. Table I-5 summarizes the projected reductions in heavy-duty emissions from the final standards in 2045 and shows the significant reductions in NO<sub>x</sub> emissions. Section VI and Regulatory Impact Analysis (RIA) Chapter 5 provide more information on our projected emission reductions for the final rule.

TABLE I-5—PROJECTED HEAVY-DUTY EMISSION REDUCTIONS IN 2045 FROM THE FINAL STANDARDS

Pollutant	Percent reduction in highway heavy-duty emissions (percent)
NO <sub>x</sub> .....	48
Primary PM <sub>2.5</sub> .....	8
VOC .....	23
CO .....	18

The final standards will also reduce emissions of other pollutants. For

instance, the final rule will result in a 28 percent reduction in benzene from highway heavy-duty engines in 2045. Leading up to 2045, emission reductions are expected to increase over time as the fleet turns over to new, compliant engines.

We expect this rule will decrease ambient concentrations of air pollutants, including significant improvements in ozone concentrations in 2045, as demonstrated in the air quality modeling analysis. We also expect reductions in ambient PM<sub>2.5</sub>, NO<sub>2</sub> and CO due to this rule. The emission reductions provided by the final standards will be important in helping areas attain and maintain the NAAQS and prevent future nonattainment. This rule's emission reductions will also reduce air pollution in close proximity to major roadways, reduce nitrogen deposition and improve visibility.

Our consideration of environmental justice literature indicates that people of color and people with low income are disproportionately exposed to elevated concentrations of many pollutants in close proximity to major roadways. We also used our air quality data from the proposal to conduct a demographic analysis of human exposure to future air quality in scenarios with and without the rule in place. Although the spatial resolution of the air quality modeling is not sufficient to capture very local heterogeneity of human exposures, particularly the pollution concentration gradients near roads, the analysis does allow estimates of demographic trends at a national scale. To compare demographic trends, we sorted 2045 baseline air quality concentrations from highest to lowest concentration and created two groups: Areas within the contiguous United States with the worst air quality and the rest of the country. We found that in the 2045 baseline, the number of people of color living within areas with the worst air quality is nearly double that of non-Hispanic Whites. We also found that the largest predicted improvements in both ozone and PM<sub>2.5</sub> are estimated to occur in areas with the worst baseline air quality, where larger numbers of people of color are projected to reside. An expanded analysis of the air quality impacts experienced by specific race and ethnic groups found that non-Hispanic Blacks will receive the greatest improvement in PM<sub>2.5</sub> and ozone concentrations as a result of the standards. More details on our air quality modeling and demographic analyses are included in Section VII and RIA Chapter 6.

2. Summary of Costs and Benefits

Our estimates of reductions in heavy-duty engine emissions and the associated air quality impacts are based on manufacturers adding emissions-reduction technologies and making emission control components more durable in response to the final standards and longer regulatory useful life periods; our estimates of emissions reductions also account for improved repair of emissions controls by owners in response to the longer emissions-related warranty periods and other provisions in the final rule.

Our program cost analysis includes both the total technology costs (*i.e.*, manufacturers' costs to add or update emissions control technologies) and the operating costs (*i.e.*, owners' costs to maintain and operate MY 2027 and later vehicles) (see Section V and RIA Chapter 7). Our evaluation of total technology costs of the final rule includes direct costs (*i.e.*, cost of materials, labor costs) and indirect manufacturing costs (*e.g.*, warranty, research and development). The direct manufacturing costs include individual technology costs for emission-related engine components and for exhaust aftertreatment systems. Importantly, our analysis of direct manufacturing costs includes the costs of the existing emission control technologies, because we expect the emissions warranty and regulatory useful life provisions in the final standards to have some impact on not only the new technology added to comply with the standards, but also on any existing emission control components. The cost estimates thus account for existing engine hardware and aftertreatment systems for which new costs will be incurred due to the new warranty and useful life provisions, even absent any changes in the level of emission standards. The indirect manufacturing costs in our analysis include the additional costs—research and development, marketing, administrative costs, etc.—incurred by manufacturers in running the company.

As part of our evaluation of operating costs, we estimate costs truck owners incur to repair emission control system components. Our repair cost estimates are based on industry data showing the amount spent annually by truck owners on different types of repairs, and our estimate of the percentage of those repairs that are related to emission control components. Our analysis of this data shows that extending the useful life and emission warranty periods will lower emission repair costs during several years of operation for several vehicle types. More discussion on our

emission repair costs estimates is included in Section V, with additional details presented in RIA Chapter 7.

We combined our estimates of emission repair costs with other operating costs (*i.e.*, urea/DEF, fuel consumption) and technology costs to calculate total program costs. Our analysis of the final standards shows that total costs for the final program relative to the baseline (or no action scenario) range from \$3.9 billion in 2027 to \$4.7 billion in 2045 (2017 dollars, undiscounted, see Table V–16). The present value of program costs for the final rule, and additional details are presented in Section V.

Section VIII presents our analysis of the human health benefits associated with the final standards. We estimate that in 2045, the final rule will result in total annual monetized ozone- and PM<sub>2.5</sub>-related benefits of \$12 and \$33

billion at a 3 percent discount rate, and \$10 and \$30 billion at a 7 percent discount rate.<sup>52</sup> These benefits only reflect those associated with reductions in NO<sub>x</sub> emissions (a precursor to both ozone and secondarily-formed PM<sub>2.5</sub>) and directly-emitted PM<sub>2.5</sub> from highway heavy-duty engines.

There are additional human health and environmental benefits associated with reductions in exposure to ambient concentrations of PM<sub>2.5</sub>, ozone, and NO<sub>2</sub> that EPA has not quantified due to data, resource, or methodological limitations. There will also be health benefits associated with reductions in air toxic pollutant emissions that result from the final program, but we did not attempt to quantify or monetize those impacts due to methodological limitations. Because we were unable to quantify and monetize all of the benefits associated

with the final program, the monetized benefits presented in this analysis are an underestimate of the program’s total benefits. More detailed information about the benefits analysis conducted for the final rule, including the present value of program benefits, is included in Section VIII and RIA Chapter 8.

We compare total monetized health benefits to total costs associated with the final rule in Section IX. Table I–6 shows that annual benefits of the final rule will be larger than the annual costs in 2045, with annual net benefits of \$6.9 and \$29 billion assuming a 3 percent discount rate, and net benefits of \$5.8 and \$25 billion assuming a 7 percent discount rate.<sup>53</sup> The benefits of the final rule also outweigh the costs when expressed in present value terms and as equalized annual values (see Section IX for these values).<sup>54</sup>

TABLE I–6—FINAL COSTS, BENEFITS AND NET BENEFITS IN 2045  
[billions, 2017\$]

	3% Discount	7% Discount
Benefits .....	\$12–\$33	\$10–\$30
Costs .....	\$4.7	\$4.7
Net Benefits .....	\$6.9–\$29	\$5.8–\$25

3. Summary of Economic Impacts

Section X examines the potential impacts of the final rule on heavy-duty vehicles (sales, mode shift, fleet turnover) and employment in the heavy-duty industry. The final rule may impact vehicle sales due to both changes in purchase price and longer emission warranty mileage requirements. The final rule may impact vehicle sales by increasing purchases of new vehicles before the final standards come into effect, in anticipation of higher prices after the standards (“pre-buy”). The final rule may also reduce sales after the final standards are in place (“low-buy”). In this final rule, we outline an approach to quantify potential impacts on vehicle sales due to new emission standards. Our illustrative analysis for this final rule, discussed in RIA Chapter 10.1, suggest pre- and low-buy for Class 8 trucks may range from zero to approximately 2 percent increase in sales over a period of up to 8 months before the 2027 standards begin (pre-buy), and a decrease in sales from zero to

approximately 3 percent over a period of up to 12 months after the 2027 standards begin (low-buy). We expect little mode shift due to the final rule because of the large difference in cost of moving goods via trucks versus other modes of transport (*e.g.*, planes or barges).

Employment impacts of the final rule depend on the effects of the rule on sales, the share of labor in the costs of the rule, and changes in labor intensity due to the rule. We quantify the effects of costs on employment, and we discuss the effects due to sales and labor intensity qualitatively. In response to comments, we have added a discussion in Chapter 10 of the RIA describing a method that could be used to quantitatively estimate a demand effect on employment, as well as an illustrative application of that method. The partial quantification of employment impacts due to increases in the costs of vehicles and parts, holding labor intensity constant, shows an increase in employment by 1,000 to 5,300 job-years in 2027.<sup>55</sup> See Section X

for further detail on limitations and assumptions of this analysis.

D. EPA Statutory Authority for This Action

This section briefly summarizes the statutory authority for the final rule. Title II of the Clean Air Act provides for comprehensive regulation of mobile sources, authorizing EPA to regulate emissions of air pollutants from all mobile source categories. Specific Title II authorities for this final rule include: CAA sections 202, 203, 206, 207, 208, 213, 216, and 301 (42 U.S.C. 7521, 7522, 7525, 7541, 7542, 7547, 7550, and 7601). We discuss some key aspects of these sections in relation to this final action immediately below (see also Section XIII of this preamble), as well as in each of the relevant sections later in this preamble. As noted in Section I.B.2.v, the final rule includes confidentiality determinations for much of the information collected by EPA for certification and compliance under Title II; see Section XI.A. for discussion of

<sup>52</sup> 2045 is a snapshot year chosen to approximate the annual health benefits that occur when the final program will be fully implemented and when most of the regulated fleet will have turned over.

<sup>53</sup> The range of benefits and net benefits reflects a combination of assumed PM<sub>2.5</sub> and ozone mortality risk estimates and selected discount rate.

<sup>54</sup> EPA’s analysis of costs and benefits does not include California’s Omnibus rule or actions by other states to adopt it. EPA is reviewing a waiver request under CAA section 209(b) from California for the Omnibus rule; until EPA grants the waiver, the HD Omnibus program is not enforceable. EPA’s analysis also does not include the recent IRA of

2022, which we anticipate will accelerate zero emissions technology in the heavy-duty sector.

<sup>55</sup> A job-year is, for example, one year of full-time work for one person, or one year of half-time work for two people.



relevant statutory authority for these final rule provisions.

Statutory authority for the final NO<sub>x</sub>, PM, HC, and CO emission standards in this action comes from CAA section 202(a), which states that “the Administrator shall by regulation prescribe (and from time to time revise) . . . standards applicable to the emission of any air pollutant from any class or classes of new . . . motor vehicle engines, which in his judgment cause, or contribute to, air pollution which may reasonably be anticipated to endanger public health or welfare.” Standards under CAA section 202(a) take effect after such period as the Administrator finds necessary to permit the development and application of the requisite technology, giving appropriate consideration to the cost of compliance within such period.”

Section 202(a)(3) further addresses EPA authority to establish standards for emissions of NO<sub>x</sub>, PM, HC, and CO from heavy-duty engines and vehicles. Section 202(a)(3)(A) requires that such standards “reflect the greatest degree of emission reduction achievable through the application of technology which the Administrator determines will be available for the model year to which such standards apply, giving appropriate consideration to cost, energy, and safety factors associated with the application of such technology.” Section 202(a)(3)(B) allows EPA to take into account air quality information in revising such standards. Section 202(a)(3)(C) provides that standards shall apply for a period of no less than three model years beginning no earlier than the model year commencing four years after promulgation. CAA section 202(a)(3)(A) is a technology-forcing provision and reflects Congress’ intent that standards be based on projections of future advances in pollution control capability, considering costs and other statutory factors.<sup>56 57</sup> CAA section 202(a)(3)

neither requires that EPA consider all the statutory factors equally nor mandates a specific method of cost-analysis; rather EPA has discretion in determining the appropriate consideration to give such factors.<sup>58</sup>

CAA section 202(d) directs EPA to prescribe regulations under which the useful life of vehicles and engines are determined and establishes minimum values of 10 years or 100,000 miles, whichever occurs first, unless EPA determines that a period of greater duration or mileage is appropriate. EPA may apply adjustment factors to assure compliance with requirements in use throughout useful life (CAA section 206(a)). CAA section 207(a) requires manufacturers to provide emissions-related warranty, which EPA last updated in its regulations for heavy-duty engines in 1983 (see 40 CFR 86.085–2).<sup>59</sup>

EPA is promulgating the final emission standards pursuant to its authority under CAA section 202(a), including 202(a)(3)(A). Section II and Chapter 4 of the RIA describe EPA’s analysis of information regarding heavy-duty engines’ contribution to air pollution and how that pollution adversely impacts public health and welfare. Sections III and IV discuss our feasibility analysis of the emission standards and useful life periods in the final rule, with more detail in Chapter 3 of the RIA. Our analysis shows that the final emission standards and useful life periods are feasible and will result in the greatest emission reductions achievable for the model years to which they will apply, pursuant to CAA section 202(a)(3), giving appropriate consideration to costs, lead time, and other factors. Our analysis of the final standards includes providing manufacturers with sufficient time to ensure that emission control components are durable enough for the longer useful life periods in the final program. In setting the final emission standards, EPA appropriately assessed the statutory factors specified in CAA

technology alone. Technology-forcing standards such as those in this final rule do not require manufacturers to use specific technologies.

<sup>56</sup> See, e.g., *Sierra Club v. EPA*, 325 F.3d 374, 378 (D.C. Cir. 2003) (explaining that similar technology-forcing language in CAA section 202(l)(2) “does not resolve how the Administrator should weigh all [the statutory] factors in the process of finding the ‘greatest emission reduction achievable’”); *Husqvarna AB v. EPA*, 254 F.3d 195, 200 (D.C. Cir. 2001) (explaining that under CAA section 213’s similar technology-forcing authority that “EPA did not deviate from its statutory mandate or frustrate congressional will by placing primary significance on the ‘greatest degree of emission reduction achievable’” or by considering cost and other statutory factors as important but secondary).

<sup>59</sup> 48 FR 52170, November 16, 1983.

section 202(a)(3)(A), including giving appropriate consideration to the cost associated with the application of technology EPA determined will be available for the model year the final standards apply (*i.e.*, cost of compliance for the manufacturer associated with the application of such technology). EPA’s assessment of the relevant statutory factors in CAA section 202(a)(3)(A) justify the final emission standards. We also evaluated additional factors, including factors to comply with E.O. 12866; our assessment of these factors lend further support to the final rule.

As proposed, we are finalizing new emission standards along with new and revised test procedures for both laboratory-based duty-cycles and off-cycle testing. Manufacturers demonstrate compliance over specified duty-cycle test procedures during pre-production testing, as well as confirmatory testing during production, which is conducted by EPA or the manufacturer. Test data and other information submitted by the manufacturer as part of their certification application are the basis on which EPA issues certificates of conformity pursuant to CAA section 206. Under CAA section 203, sales of new vehicles are prohibited unless the vehicle is covered by a certificate of conformity. Compliance with engine emission standards is required throughout the regulatory useful life of the engine, not only at certification but throughout the regulatory useful life in-use in the real world. In-use engines can be tested for compliance with duty-cycle and off-cycle standards, with testing over corresponding specific duty-cycle test procedures and off-cycle test procedures, either on the road or in the laboratory (see Section III for more discussion on for testing at various stages in the life of an engine).

Also as proposed, we are finalizing lengthened regulatory useful life and emission warranty periods to better reflect the mileages and time periods over which heavy-duty engines are driven today. These and other provisions in the final rule are further discussed in the preamble sections that follow. The proposed rule (87 FR 17414, March 28, 2022) includes additional information relevant to the development of this rule, including: History of Emissions Standards for Heavy-duty Engines and Vehicles; Petitions to EPA for Additional NO<sub>x</sub> control; the California Heavy-Duty Highway Low NO<sub>x</sub> Program Development; and the Advance Notice of Proposed Rulemaking.

<sup>56</sup> See *National Petrochemical & Refiners Association v. EPA*, 287 F.3d 1130, 1136 (D.C. Cir. 2002) (explaining that EPA is authorized to adopt “technology-forcing” regulations under CAA section 202(a)(3)); *NRDC v. Thomas*, 805 F.2d 410, 428 n.30 (D.C. Cir. 1986) (explaining that such statutory language that “seek[s] to promote technological advances while also accounting for cost does not detract from their categorization as technology-forcing standards”); see also *Husqvarna AB v. EPA*, 254 F.3d 195 (D.C. Cir. 2001) (explaining that CAA sections 202 and 213 have similar language and are technology-forcing standards).

<sup>57</sup> In this context, the term “technology-forcing” has a specific legal meaning and is used to distinguish standards that may require manufacturers to develop new technologies (or significantly improve existing technologies) from standards that can be met using off-the-shelf

## II. Need for Additional Emissions Control

This final rule will reduce emissions from heavy-duty engines that contribute to ambient levels of ozone, PM, NO<sub>x</sub> and CO, which are all pollutants for which EPA has established health-based NAAQS. These pollutants are linked to premature death, respiratory illness (including childhood asthma), cardiovascular problems, and other adverse health impacts. Many groups are at greater risk than healthy people from these pollutants, including people with heart or lung disease, outdoor workers, older adults and children. These pollutants also reduce visibility and negatively impact ecosystems. This final rule will also reduce emissions of air toxics from heavy-duty engines. A more detailed discussion of the health and environmental effects associated with the pollutants affected by this rule is included in Sections II.B and II.C and Chapter 4 of the RIA.

Populations who live, work, or go to school near high-traffic roadways experience higher rates of numerous adverse health effects, compared to populations far away from major roads. We note that there is substantial evidence that people who live or attend school near major roadways are more likely to be people of color, Hispanic ethnicity, and/or low socioeconomic status.

Across the United States, NO<sub>x</sub> emissions from heavy-duty engines are important contributors to concentrations of ozone and PM<sub>2.5</sub> and their resulting threat to public health.<sup>60 61</sup> The emissions modeling done for the final rule (see Chapter 5 of the RIA) indicates that without these standards, heavy-duty engines will continue to be one of the largest contributors to mobile source NO<sub>x</sub> emissions nationwide in the future, representing 32 percent of the mobile source NO<sub>x</sub> in calendar year 2045.<sup>62</sup> Furthermore, it is estimated that heavy-duty engines would represent 90 percent of the onroad NO<sub>x</sub> inventory in calendar year 2045.<sup>63</sup> The emission reductions that will occur from the final

rule are projected to reduce air pollution that is (and is projected to continue to be) at levels that endanger public health and welfare. For the reasons discussed in this Section II, EPA concludes that new standards are warranted to address the emissions of these pollutants and their contribution to national air pollution. We note that in the summer of 2016 more than 20 organizations, including state and local air agencies from across the country, petitioned EPA to develop more stringent NO<sub>x</sub> emission standards for on-road heavy-duty engines.<sup>64 65</sup> Among the reasons stated by the petitioners for such an EPA rulemaking was the need for NO<sub>x</sub> emission reductions to reduce adverse health and welfare impacts and to help areas attain the NAAQS. EPA responded to the petitions on December 20, 2016, noting that an opportunity exists to develop a new national NO<sub>x</sub> reduction strategy for heavy-duty highway engines.<sup>66</sup> We subsequently initiated this rulemaking and issued an Advanced Notice of Proposed Rulemaking in January 2020.<sup>67</sup> This final rule culminates the rulemaking proceeding and is responsive to those petitions.

Many state and local agencies across the country commented on the NPRM and have asked the EPA to reduce NO<sub>x</sub> emissions, specifically from heavy-duty engines, because such reductions will be a critical part of many areas' strategies to attain and maintain the ozone and PM NAAQS. These state and local agencies anticipate challenges in attaining the NAAQS, maintaining the NAAQS in the future, and/or preventing nonattainment. Some nonattainment areas have already been "bumped up" to higher classifications because of challenges in attaining the NAAQS; others say they are struggling to avoid nonattainment.<sup>68</sup> Others note that the

ozone and PM NAAQS are being reconsidered so they could be made more stringent in the future.<sup>69 70</sup> Many state and local agencies commented on the NPRM that heavy-duty vehicles are one of their largest sources of NO<sub>x</sub> emissions. They commented that without action to reduce emissions from heavy-duty vehicles, they will have to adopt other potentially more burdensome and costly measures to reduce emissions from other sources under their state or local authority, such as local businesses. More information on the projected emission reductions and air quality impacts that will result from this rule is provided in Sections VI and VII.

In their comments on the NPRM, many nonprofit groups, citizen groups, individuals, and state, local, and Tribal organizations emphasized the role that emissions from trucks have in harming communities and that communities living near truck routes are disproportionately people of color and those with lower incomes. They supported additional NO<sub>x</sub> reductions from heavy-duty vehicles to address concerns about environmental justice and ensuring that all communities benefit from improvements in air quality. In addition, many groups and commenters noted the link between emissions from heavy duty trucks and harmful health effects, in particular asthma in children. Commenters also supported additional NO<sub>x</sub> reductions from heavy-duty vehicles to address concerns about regional haze, and damage to terrestrial and aquatic ecosystems. They mentioned the impacts of NO<sub>x</sub> emissions on numerous locations, such as the Chesapeake Bay, Long Island Sound, the Rocky Mountains, Sierra Nevada Mountains, Appalachian Mountains, Southwestern Desert ecosystems, and other areas. For further detail regarding these comments and EPA's responses, see Section 2 of the Response to Comments document for this rulemaking.

### A. Background on Pollutants Impacted by This Proposal

#### 1. Ozone

Ground-level ozone pollution forms in areas with high concentrations of ambient nitrogen oxides (NO<sub>x</sub>) and

nonattainment of the 2015 ozone NAAQS from marginal to moderate. The 2008 NAAQS for ozone is an 8-hour standard with a level of 0.075 ppm, which the 2015 ozone NAAQS lowered to 0.070 ppm.

<sup>69</sup> <https://www.epa.gov/ground-level-ozone-pollution/epa-reconsider-previous-administrations-decision-retain-2015-ozone>.

<sup>70</sup> <https://www.epa.gov/pm-pollution/national-air-quality-standards-naaqs-pm>.

<sup>60</sup> Zawacki et al., 2018. Mobile source contributions to ambient ozone and particulate matter in 2025. *Atmospheric Environment*, Vol 188, pg 129–141. Available online: <https://doi.org/10.1016/j.atmosenv.2018.04.057>.

<sup>61</sup> Davidson et al., 2020. The recent and future health burden of the U.S. mobile sector apportioned by source. *Environmental Research Letters*. Available online: <https://doi.org/10.1088/1748-9326/ab3a8>.

<sup>62</sup> Sectors other than onroad and nonroad were projected from 2016v1 Emissions Modeling Platform. <https://www.epa.gov/air-emissions-modeling/2016v1-platform>.

<sup>63</sup> U.S. EPA (2020) Motor Vehicle Emission Simulator: MOVES3. <https://www.epa.gov/moves>.

<sup>64</sup> Brakora, Jessica. "Petitions to EPA for Revised NO<sub>x</sub> Standards for Heavy-Duty Engines" Memorandum to Docket EPA-HQ-OAR-2019-0055. December 4, 2019.

<sup>65</sup> 87 FR 17414, March 28, 2022.

<sup>66</sup> U.S. EPA. 2016. Memorandum in Response to Petition for Rulemaking to Adopt Ultra-Low NO<sub>x</sub> Standards for On-Highway Heavy-Duty Trucks and Engines. Available at <https://19january2017snapshot.epa.gov/sites/production/files/2016-12/documents/nox-memorandum-nox-petition-response-2016-12-20.pdf>.

<sup>67</sup> The Agency published an ANPR on January 21, 2020 to present EPA's early thinking on this rulemaking and solicit feedback from stakeholders to inform this proposal (85 FR 3306).

<sup>68</sup> For example, in September 2019 several 2008 ozone nonattainment areas were reclassified from moderate to serious, including Dallas, Chicago, Connecticut, New York/New Jersey and Houston, and in January 2020, Denver. Also, on September 15, 2022, EPA finalized reclassification, bumping up 5 areas in nonattainment of the 2008 ozone NAAQS from serious to severe and 22 areas in

volatile organic compounds (VOCs) when solar radiation is strong. Major U.S. sources of NO<sub>x</sub> are highway and nonroad motor vehicles, engines, power plants and other industrial sources, with natural sources, such as soil, vegetation, and lightning, serving as smaller sources. Vegetation is the dominant source of VOCs in the United States. Volatile consumer and commercial products, such as propellants and solvents, highway and nonroad vehicles, engines, fires, and industrial sources also contribute to the atmospheric burden of VOCs at ground-level.

The processes underlying ozone formation, transport, and accumulation are complex. Ground-level ozone is produced and destroyed by an interwoven network of free radical reactions involving the hydroxyl radical (OH), NO, NO<sub>2</sub>, and complex reaction intermediates derived from VOCs. Many of these reactions are sensitive to temperature and available sunlight. High ozone events most often occur when ambient temperatures and sunlight intensities remain high for several days under stagnant conditions. Ozone and its precursors can also be transported hundreds of miles downwind, which can lead to elevated ozone levels in areas with otherwise low VOC or NO<sub>x</sub> emissions. As an air mass moves and is exposed to changing ambient concentrations of NO<sub>x</sub> and VOCs, the ozone photochemical regime (relative sensitivity of ozone formation to NO<sub>x</sub> and VOC emissions) can change.

When ambient VOC concentrations are high, comparatively small amounts of NO<sub>x</sub> catalyze rapid ozone formation. Without available NO<sub>x</sub>, ground-level ozone production is severely limited, and VOC reductions would have little impact on ozone concentrations. Photochemistry under these conditions is said to be “NO<sub>x</sub>-limited.” When NO<sub>x</sub> levels are sufficiently high, faster NO<sub>2</sub> oxidation consumes more radicals, dampening ozone production. Under these “VOC-limited” conditions (also referred to as “NO<sub>x</sub>-saturated” conditions), VOC reductions are effective in reducing ozone, and NO<sub>x</sub> can react directly with ozone, resulting in suppressed ozone concentrations near NO<sub>x</sub> emission sources. Under these NO<sub>x</sub>-saturated conditions, NO<sub>x</sub> reductions can actually increase local ozone under certain circumstances, but overall ozone production (considering downwind formation) decreases. Even in VOC-limited areas, NO<sub>x</sub> reductions are not expected to increase ozone levels if the NO<sub>x</sub> reductions are sufficiently large—large enough to become NO<sub>x</sub>-limited.

The primary NAAQS for ozone, established in 2015 and retained in 2020, is an 8-hour standard with a level of 0.07 ppm.<sup>71</sup> EPA announced that it will reconsider the decision to retain the ozone NAAQS.<sup>72</sup> The EPA is also implementing the previous 8-hour ozone primary standard, set in 2008, at a level of 0.075 ppm. As of August 31, 2022, there were 34 ozone nonattainment areas for the 2008 ozone NAAQS, composed of 141 full or partial counties, with a population of more than 90 million, and 49 ozone nonattainment areas for the 2015 ozone NAAQS, composed of 212 full or partial counties, with a population of more than 125 million. In total, there are currently, as of August 31, 2022, 57 ozone nonattainment areas with a population of more than 130 million people.<sup>73</sup>

States with ozone nonattainment areas are required to take action to bring those areas into attainment. The attainment date assigned to an ozone nonattainment area is based on the area’s classification. The attainment dates for areas designated nonattainment for the 2008 8-hour ozone NAAQS are in the 2015 to 2032 timeframe, depending on the severity of the problem in each area. Attainment dates for areas designated nonattainment for the 2015 ozone NAAQS are in the 2021 to 2038 timeframe, again depending on the severity of the problem in each area.<sup>74</sup> The final NO<sub>x</sub> standards will take effect starting in MY 2027 and will assist areas with attaining the NAAQS and may relieve areas with already stringent local regulations from some of the burden associated with adopting additional local controls.<sup>75</sup> The rule will also

<sup>71</sup> <https://www.epa.gov/ground-level-ozone-pollution/ozone-national-ambient-air-quality-standards-naaqs>.

<sup>72</sup> <https://www.epa.gov/ground-level-ozone-pollution/epa-reconsider-previous-administrations-decision-retain-2015-ozone>.

<sup>73</sup> The population total is calculated by summing, without double counting, the 2008 and 2015 ozone nonattainment populations contained in the Criteria Pollutant Nonattainment Summary report (<https://www.epa.gov/green-book/green-book-data-download>).

<sup>74</sup> <https://www.epa.gov/ground-level-ozone-pollution/ozone-naaqs-timelines>.

<sup>75</sup> While not quantified in the air quality modeling analysis for this rule, elements of the Averaging, Banking, and Trading (ABT) program could encourage manufacturers to introduce new emission control technologies prior to the 2027 model year, which may help to accelerate some emission reductions of the final rule (See Preamble Section IV.G for more details on the ABT program in the final rule). In RIA Chapter 5.5 we also include a sensitivity analysis that shows allowing manufacturers to generate NO<sub>x</sub> emissions credits by meeting requirements of the final rule one model year before required would lead to meaningful, additional reductions in NO<sub>x</sub> emissions in the early

provide assistance to counties with ambient concentrations near the level of the NAAQS who are working to ensure long-term attainment or maintenance of the NAAQS.

## 2. Particulate Matter

Particulate matter (PM) is a complex mixture of solid particles and liquid droplets distributed among numerous atmospheric gases which interact with solid and liquid phases. Particles in the atmosphere range in size from less than 0.01 to more than 10 micrometers (μm) in diameter.<sup>76</sup> Atmospheric particles can be grouped into several classes according to their aerodynamic diameter and physical sizes. Generally, the three broad classes of particles include ultrafine particles (UFPs, generally considered as particles with a diameter less than or equal to 0.1 μm [typically based on physical size, thermal diffusivity or electrical mobility]), “fine” particles (PM<sub>2.5</sub>; particles with a nominal mean aerodynamic diameter less than or equal to 2.5 μm), and “thoracic” particles (PM<sub>10</sub>; particles with a nominal mean aerodynamic diameter less than or equal to 10 μm). Particles that fall within the size range between PM<sub>2.5</sub> and PM<sub>10</sub>, are referred to as “thoracic coarse particles” (PM<sub>10–2.5</sub>, particles with a nominal mean aerodynamic diameter greater than 2.5 μm and less than or equal to 10 μm). EPA currently has NAAQS for PM<sub>2.5</sub> and PM<sub>10</sub>.<sup>77</sup>

Most particles are found in the lower troposphere, where they can have residence times ranging from a few hours to weeks. Particles are removed from the atmosphere by wet deposition, such as when they are carried by rain or snow, or by dry deposition, when particles settle out of suspension due to gravity. Atmospheric lifetimes are generally longest for PM<sub>2.5</sub>, which often remains in the atmosphere for days to weeks before being removed by wet or dry deposition.<sup>78</sup> In contrast,

years of the program compared to the emissions reductions expected from the final rule (see preamble Section IV.G.7 and RIA Chapter 5.5 for additional details).

<sup>76</sup> U.S. EPA. Policy Assessment (PA) for the Review of the National Ambient Air Quality Standards for Particulate Matter (Final Report, 2020). U.S. Environmental Protection Agency, Washington, DC, EPA/452/R-20/002, 2020.

<sup>77</sup> Regulatory definitions of PM size fractions, and information on reference and equivalent methods for measuring PM in ambient air, are provided in 40 CFR parts 50, 53, and 58. With regard to NAAQS which provide protection against health and welfare effects, the 24-hour PM<sub>10</sub> standard provides protection against effects associated with short-term exposure to thoracic coarse particles (*i.e.*, PM<sub>10–2.5</sub>).

<sup>78</sup> U.S. EPA. Integrated Science Assessment (ISA) for Particulate Matter (Final Report, 2019). U.S.

atmospheric lifetimes for UFP and PM<sub>10-2.5</sub> are shorter. Within hours, UFP can undergo coagulation and condensation that lead to formation of larger particles, or can be removed from the atmosphere by evaporation, deposition, or reactions with other atmospheric components. PM<sub>10-2.5</sub> are also generally removed from the atmosphere within hours, through wet or dry deposition.<sup>79</sup>

Particulate matter consists of both primary and secondary particles. Primary particles are emitted directly from sources, such as combustion-related activities (*e.g.*, industrial activities, motor vehicle operation, biomass burning), while secondary particles are formed through atmospheric chemical reactions of gaseous precursors (*e.g.*, sulfur oxides (SO<sub>x</sub>), NO<sub>x</sub>, and VOCs).

There are two primary NAAQS for PM<sub>2.5</sub>: An annual standard (12.0 micrograms per cubic meter (μg/m<sup>3</sup>)) and a 24-hour standard (35 μg/m<sup>3</sup>), and there are two secondary NAAQS for PM<sub>2.5</sub>: An annual standard (15.0 μg/m<sup>3</sup>) and a 24-hour standard (35 μg/m<sup>3</sup>). The initial PM<sub>2.5</sub> standards were set in 1997 and revisions to the standards were finalized in 2006 and in December 2012 and then retained in 2020. On June 10, 2021, EPA announced that it will reconsider the decision to retain the PM NAAQS.<sup>80</sup>

There are many areas of the country that are currently in nonattainment for the annual and 24-hour primary PM<sub>2.5</sub> NAAQS. As of August 31, 2022, more than 19 million people lived in the 4 areas that are designated as nonattainment for the 1997 PM<sub>2.5</sub> NAAQS. Also, as of August 31, 2022, more than 31 million people lived in the 14 areas that are designated as nonattainment for the 2006 PM<sub>2.5</sub> NAAQS and more than 20 million people lived in the 5 areas designated as nonattainment for the 2012 PM<sub>2.5</sub> NAAQS. In total, there are currently 15 PM<sub>2.5</sub> nonattainment areas with a population of more than 32 million people.<sup>81</sup> The final NO<sub>x</sub> standards will take effect in MY 2027 and will assist areas with attaining the NAAQS and

may relieve areas with already stringent local regulations from some of the burden associated with adopting additional local controls.<sup>82</sup> The rule will also assist counties with ambient concentrations near the level of the NAAQS who are working to ensure long-term attainment or maintenance of the PM<sub>2.5</sub> NAAQS.

### 3. Nitrogen Oxides

Oxides of nitrogen (NO<sub>x</sub>) refers to nitric oxide (NO) and nitrogen dioxide (NO<sub>2</sub>). Most NO<sub>2</sub> is formed in the air through the oxidation of NO emitted when fuel is burned at a high temperature. NO<sub>2</sub> is a criteria pollutant, regulated for its adverse effects on public health and the environment, and highway vehicles are an important contributor to NO<sub>2</sub> emissions. NO<sub>x</sub>, along with VOCs, are the two major precursors of ozone and NO<sub>x</sub> is also a major contributor to secondary PM<sub>2.5</sub> formation. There are two primary NAAQS for NO<sub>2</sub>: An annual standard (53 ppb) and a 1-hour standard (100 ppb).<sup>83</sup> In 2010, EPA established requirements for monitoring NO<sub>2</sub> near roadways expected to have the highest concentrations within large cities. Monitoring within this near-roadway network began in 2014, with additional sites deployed in the following years. At present, there are no nonattainment areas for NO<sub>2</sub>.

### 4. Carbon Monoxide

Carbon monoxide (CO) is a colorless, odorless gas emitted from combustion processes. Nationally, particularly in urban areas, the majority of CO emissions to ambient air come from mobile sources.<sup>84</sup> There are two primary NAAQS for CO: An 8-hour standard (9 ppm) and a 1-hour standard (35 ppm). There are currently no CO nonattainment areas; as of September 27, 2010, all CO nonattainment areas have been redesignated to attainment. The past designations were based on the existing community-wide monitoring network. EPA made an addition to the

ambient air monitoring requirements for CO during the 2011 NAAQS review. Those new requirements called for CO monitors to be operated near roads in Core Based Statistical Areas (CBSAs) of 1 million or more persons, in addition to the existing community-based network (76 FR 54294, August 31, 2011).

### 5. Diesel Exhaust

Diesel exhaust is a complex mixture composed of particulate matter, carbon dioxide, oxygen, nitrogen, water vapor, carbon monoxide, nitrogen compounds, sulfur compounds and numerous low-molecular-weight hydrocarbons. A number of these gaseous hydrocarbon components are individually known to be toxic, including aldehydes, benzene and 1,3-butadiene. The diesel particulate matter present in diesel exhaust consists mostly of fine particles (<2.5 μm), of which a significant fraction is ultrafine particles (<0.1 μm). These particles have a large surface area which makes them an excellent medium for adsorbing organics and their small size makes them highly respirable. Many of the organic compounds present in the gases and on the particles, such as polycyclic organic matter, are individually known to have mutagenic and carcinogenic properties.

Diesel exhaust varies significantly in chemical composition and particle sizes between different engine types (heavy-duty, light-duty), engine operating conditions (idle, acceleration, deceleration), and fuel formulations (high/low sulfur fuel). Also, there are emissions differences between on-road and nonroad engines because the nonroad engines are generally of older technology. After being emitted in the engine exhaust, diesel exhaust undergoes dilution as well as chemical and physical changes in the atmosphere. The lifetime of the components present in diesel exhaust ranges from seconds to days.

Because diesel particulate matter (DPM) is part of overall ambient PM, varies considerably in composition, and lacks distinct chemical markers that enable it to be easily distinguished from overall primary PM, we do not have direct measurements of DPM in the ambient air.<sup>85</sup> DPM concentrations are

<sup>85</sup> DPM in exhaust from a high-load, high-speed engine (*e.g.*, heavy-duty truck engines) without aftertreatment such as a diesel particle filter (DPM) is mostly made of "soot," consisting of elemental/black carbon (EC/BC), some organic material, and trace elements. At low loads, DPM in high-speed engine exhaust is mostly made of organic carbon (OC), with considerably less EC/BC. Low-speed diesel engines' (*e.g.*, large marine engines) exhaust

Continued

Environmental Protection Agency, Washington, DC, EPA/600/R-19/188, 2019. Table 2-1.

<sup>79</sup> U.S. EPA. Integrated Science Assessment (ISA) for Particulate Matter (Final Report, 2019). U.S. Environmental Protection Agency, Washington, DC, EPA/600/R-19/188, 2019. Table 2-1.

<sup>80</sup> <https://www.epa.gov/pm-pollution/national-ambient-air-quality-standards-naaqs-pm>.

<sup>81</sup> The population total is calculated by summing, without double counting, the 1997, 2006 and 2012 PM<sub>2.5</sub> nonattainment populations contained in the Criteria Pollutant Nonattainment Summary report (<https://www.epa.gov/green-book/green-book-data-download>).

<sup>82</sup> While not quantified in the air quality modeling analysis for this rule, elements of the Averaging, Banking, and Trading (ABT) program could encourage manufacturers to introduce new emission control technologies prior to the 2027 model year, which may help to accelerate some emission reductions of the final rule (See Preamble Section IV.G for more details on the ABT program in the final rule).

<sup>83</sup> The statistical form of the 1-hour NAAQS for NO<sub>2</sub> is the 3-year average of the yearly distribution of 1-hour daily maximum concentrations.

<sup>84</sup> U.S. EPA, (2010). Integrated Science Assessment for Carbon Monoxide (Final Report). U.S. Environmental Protection Agency, Washington, DC, EPA/600/R-09/019F, 2010. <http://cfpub.epa.gov/ncea/cfm/recordisplay.cfm?deid=218686>. See Section 2.1.

estimated using ambient air quality modeling based on DPM emission inventories. DPM emission inventories are computed as the exhaust PM emissions from mobile sources combusting diesel or residual oil fuel. DPM concentrations were estimated as part of the 2018 national Air Toxics Screening Assessment (AirToxScreen).<sup>86</sup> Areas with high concentrations are clustered in the Northeast and Great Lake States, with a smaller number of higher concentration locations in Western states. The highest impacts occur in major urban cores, and are also distributed throughout the rest of the United States near high truck traffic, coasts with marine diesel activity, construction sites, and rail facilities. Approximately half of the average ambient DPM concentration in the United States can be attributed to heavy-duty diesel engines, with the remainder attributable to nonroad engines.

## 6. Air Toxics

The most recent available data indicate that millions of Americans live in areas where air toxics pose potential health concerns.<sup>87</sup> The levels of air toxics to which people are exposed vary depending on where people live and work and the kinds of activities in which they engage, as discussed in detail in EPA's 2007 Mobile Source Air Toxics Screening Assessment (AirToxScreen) for 2018, mobile sources were responsible for 40 percent of outdoor anthropogenic toxic emissions and were the largest contributor to national average cancer and noncancer risk from directly emitted pollutants.<sup>89</sup> Mobile sources are also significant contributors to precursor

PM is comprised of more sulfate and less EC/BC, with OC contributing as well.

<sup>86</sup> U.S. EPA (2022) Technical Support Document EPA Air Toxics Screening Assessment. 2018AirToxScreen TSD. <https://www.epa.gov/AirToxScreen/airtoxscreen-technical-support-document>.

<sup>87</sup> U.S. EPA (2022) Technical Support Document EPA Air Toxics Screening Assessment. 2017AirToxScreen TSD. [https://www.epa.gov/system/files/documents/2022-03/airtoxscreen\\_2017tsd.pdf](https://www.epa.gov/system/files/documents/2022-03/airtoxscreen_2017tsd.pdf).

<sup>88</sup> U.S. Environmental Protection Agency (2007). Control of Hazardous Air Pollutants from Mobile Sources; Final Rule. 72 FR 8434, February 26, 2007.

<sup>89</sup> U.S. EPA. (2022) Air Toxics Screening Assessment. <https://www.epa.gov/AirToxScreen/2018-airtoxscreen-assessment-results>.

<sup>90</sup> AirToxScreen also includes estimates of risk attributable to background concentrations, which includes contributions from long-range transport, persistent air toxics, and natural sources; as well as secondary concentrations, where toxics are formed via secondary formation. Mobile sources substantially contribute to long-range transport and secondarily formed air toxics.

emissions which react to form air toxics.<sup>91</sup> Formaldehyde is the largest contributor to cancer risk of all 71 pollutants quantitatively assessed in the 2018 AirToxScreen. Mobile sources were responsible for 26 percent of primary anthropogenic emissions of this pollutant in 2018 and are significant contributors to formaldehyde precursor emissions. Benzene is also a large contributor to cancer risk, and mobile sources account for about 60 percent of average exposure to ambient concentrations.

### B. Health Effects Associated With Exposure to Pollutants Impacted by This Rule

Heavy-duty engines emit pollutants that contribute to ambient concentrations of ozone, PM, NO<sub>2</sub>, CO, and air toxics. This section of the preamble discusses the health effects associated with exposure to these pollutants.

Additionally, because children have increased vulnerability and susceptibility for adverse health effects related to air pollution exposures, EPA's findings regarding adverse effects for children related to exposure to pollutants that are impacted by this rule are noted in this section. The increased vulnerability and susceptibility of children to air pollution exposures may arise because infants and children generally breathe more relative to their size than adults do, and consequently may be exposed to relatively higher amounts of air pollution.<sup>92</sup> Children also tend to breathe through their mouths more than adults and their nasal passages are less effective at removing pollutants, which leads to greater lung deposition of some pollutants, such as PM.<sup>93</sup> Furthermore, air pollutants may pose health risks specific to children because children's bodies are still

<sup>91</sup> Rich Cook, Sharon Phillips, Madeleine Strum, Alison Eyth & James Thurman (2020): Contribution of mobile sources to secondary formation of carbonyl compounds, *Journal of the Air & Waste Management Association*, DOI: 10.1080/10962247.2020.1813839.

<sup>92</sup> EPA (2009) Metabolically-derived ventilation rates: A revised approach based upon oxygen consumption rates. Washington, DC: Office of Research and Development. EPA/600/R-06/129F. <http://cfpub.epa.gov/ncea/cfm/recordisplay.cfm?deid=202543>.

<sup>93</sup> U.S. EPA Integrated Science Assessment for Particulate Matter (Final Report, 2019). U.S. Environmental Protection Agency, Washington, DC, EPA/600/R-19/188, 2019. Chapter 4 "Overall Conclusions" p. 4-1.

<sup>94</sup> Foos, B.; Marty, M.; Schwartz, J.; Bennet, W.; Moya, J.; Jarabek, A.M.; Salmon, A.G. (2008) Focusing on children's inhalation dosimetry and health effects for risk assessment: An introduction. *J Toxicol Environ Health* 71A: 149-165.

developing.<sup>95</sup> For example, during periods of rapid growth such as fetal development, infancy, and puberty, their developing systems and organs may be more easily harmed.<sup>96</sup> EPA's America's Children and the Environment is a tool which presents national trends on air pollutants and other contaminants and environmental health of children.<sup>98</sup>

Information on environmental effects associated with exposure to these pollutants is included in Section II.C, and information on environmental justice is included in Section VII.H. Information on emission reductions and air quality impacts from this rule are included in Section VI and VII.

## 1. Ozone

This section provides a summary of the health effects associated with exposure to ambient concentrations of ozone.<sup>99</sup> The information in this section is based on the information and conclusions in the April 2020 Integrated Science Assessment for Ozone (Ozone ISA).<sup>100</sup> The Ozone ISA concludes that human exposures to ambient concentrations of ozone are associated with a number of adverse health effects and characterizes the weight of evidence for these health effects.<sup>101</sup> The following discussion highlights the Ozone ISA's

<sup>95</sup> Children's environmental health includes conception, infancy, early childhood and through adolescence until 21 years of age as described in the EPA Memorandum: Issuance of EPA's 2021 Policy on Children's Health. October 5, 2021. Available at <https://www.epa.gov/system/files/documents/2021-10/2021-policy-on-childrens-health.pdf>.

<sup>96</sup> EPA (2006) A Framework for Assessing Health Risks of Environmental Exposures to Children. EPA, Washington, DC, EPA/600/R-05/093F, 2006.

<sup>97</sup> U.S. Environmental Protection Agency. (2005). Supplemental guidance for assessing susceptibility from early-life exposure to carcinogens. Washington, DC: Risk Assessment Forum. EPA/630/R-03/003F. [https://www3.epa.gov/airtoxics/childrens\\_supplement\\_final.pdf](https://www3.epa.gov/airtoxics/childrens_supplement_final.pdf).

<sup>98</sup> U.S. EPA. America's Children and the Environment. Available at: <https://www.epa.gov/americaschildrenenvironment>.

<sup>99</sup> Human exposure to ozone varies over time due to changes in ambient ozone concentration and because people move between locations which have notably different ozone concentrations. Also, the amount of ozone delivered to the lung is influenced not only by the ambient concentrations but also by the breathing route and rate.

<sup>100</sup> U.S. EPA. Integrated Science Assessment (ISA) for Ozone and Related Photochemical Oxidants (Final Report). U.S. Environmental Protection Agency, Washington, DC, EPA/600/R-20/012, 2020.

<sup>101</sup> The ISA evaluates evidence and draws conclusions on the causal relationship between relevant pollutant exposures and health effects, assigning one of five "weight of evidence" determinations: causal relationship, likely to be a causal relationship, suggestive of a causal relationship, inadequate to infer a causal relationship, and not likely to be a causal relationship. For more information on these levels of evidence, please refer to Table II in the Preamble of the ISA.

conclusions pertaining to health effects associated with both short-term and long-term periods of exposure to ozone.

For short-term exposure to ozone, the Ozone ISA concludes that respiratory effects, including lung function decrements, pulmonary inflammation, exacerbation of asthma, respiratory-related hospital admissions, and mortality, are causally associated with ozone exposure. It also concludes that metabolic effects, including metabolic syndrome (*i.e.*, changes in insulin or glucose levels, cholesterol levels, obesity, and blood pressure) and complications due to diabetes are likely to be causally associated with short-term exposure to ozone. The evidence is also suggestive of a causal relationship between short-term exposure to ozone and cardiovascular effects, central nervous system effects, and total mortality.

For long-term exposure to ozone, the Ozone ISA concludes that respiratory effects, including new onset asthma, pulmonary inflammation, and injury, are likely to be causally related with ozone exposure. The Ozone ISA characterizes the evidence as suggestive of a causal relationship for associations between long-term ozone exposure and cardiovascular effects, metabolic effects, reproductive and developmental effects, central nervous system effects, and total mortality. The evidence is inadequate to infer a causal relationship between chronic ozone exposure and increased risk of cancer.

Finally, interindividual variation in human responses to ozone exposure can result in some groups being at increased risk for detrimental effects in response to exposure. In addition, some groups are at increased risk of exposure due to their activities, such as outdoor workers and children. The Ozone ISA identified several groups that are at increased risk for ozone-related health effects. These groups are people with asthma, children and older adults, individuals with reduced intake of certain nutrients (*i.e.*, Vitamins C and E), outdoor workers, and individuals having certain genetic variants related to oxidative metabolism or inflammation. Ozone exposure during childhood can have lasting effects through adulthood. Such effects include altered function of the respiratory and immune systems. Children absorb higher doses (normalized to lung surface area) of ambient ozone, compared to adults, due to their increased time spent outdoors, higher ventilation rates relative to body size, and a tendency to breathe a greater fraction of air through the mouth. Children also have a higher asthma prevalence compared to adults. Recent

epidemiologic studies provide generally consistent evidence that long-term ozone exposure is associated with the development of asthma in children. Studies comparing age groups reported higher magnitude associations for short-term ozone exposure and respiratory hospital admissions and emergency room visits among children than among adults. Panel studies also provide support for experimental studies with consistent associations between short-term ozone exposure and lung function and pulmonary inflammation in healthy children. Additional children's vulnerability and susceptibility factors are listed in Section XII of this preamble.

## 2. Particulate Matter

Scientific evidence spanning animal toxicological, controlled human exposure, and epidemiologic studies shows that exposure to ambient PM is associated with a broad range of health effects. These health effects are discussed in detail in the Integrated Science Assessment for Particulate Matter, which was finalized in December 2019 (PM ISA). In addition, there is a more targeted evaluation of studies published since the literature cutoff date of the 2019 p.m. ISA in the Supplement to the Integrated Science Assessment for PM (Supplement).<sup>102</sup> <sup>103</sup> The PM ISA characterizes the causal nature of relationships between PM exposure and broad health categories (*e.g.*, cardiovascular effects, respiratory effects, etc.) using a weight-of-evidence approach.<sup>104</sup> Within this characterization, the PM ISA summarizes the health effects evidence

<sup>102</sup> U.S. EPA. Integrated Science Assessment (ISA) for Particulate Matter (Final Report, 2019). U.S. Environmental Protection Agency, Washington, DC, EPA/600/R-19/188, 2019.

<sup>103</sup> U.S. EPA. Supplement to the 2019 Integrated Science Assessment for Particulate Matter (Final Report, 2022). U.S. Environmental Protection Agency, Washington, DC, EPA/635/R-22/028, 2022.

<sup>104</sup> The causal framework draws upon the assessment and integration of evidence from across scientific disciplines, spanning atmospheric chemistry, exposure, dosimetry and health effects studies (*i.e.*, epidemiologic, controlled human exposure, and animal toxicological studies), and assess the related uncertainties and limitations that ultimately influence our understanding of the evidence. This framework employs a five-level hierarchy that classifies the overall weight-of-evidence with respect to the causal nature of relationships between criteria pollutant exposures and health and welfare effects using the following categorizations: causal relationship; likely to be causal relationship; suggestive of, but not sufficient to infer, a causal relationship; inadequate to infer the presence or absence of a causal relationship; and not likely to be a causal relationship (U.S. EPA. (2019). Integrated Science Assessment for Particulate Matter (Final Report). U.S. Environmental Protection Agency, Washington, DC, EPA/600/R-19/188, Section P. 3.2.3).

for short-term (*i.e.*, hours up to one month) and long-term (*i.e.*, one month to years) exposures to PM<sub>2.5</sub>, PM<sub>10-2.5</sub>, and ultrafine particles, and concludes that exposures to ambient PM<sub>2.5</sub> are associated with a number of adverse health effects. The following discussion highlights the PM ISA's conclusions, and summarizes additional information from the Supplement where appropriate, pertaining to the health effects evidence for both short- and long-term PM exposures. Further discussion of PM-related health effects can also be found in the 2022 Policy Assessment for the review of the PM NAAQS.<sup>105</sup>

EPA has concluded that recent evidence in combination with evidence evaluated in the 2009 p.m. ISA supports a "causal relationship" between both long- and short-term exposures to PM<sub>2.5</sub> and premature mortality and cardiovascular effects and a "likely to be causal relationship" between long- and short-term PM<sub>2.5</sub> exposures and respiratory effects.<sup>106</sup> Additionally, recent experimental and epidemiologic studies provide evidence supporting a "likely to be causal relationship" between long-term PM<sub>2.5</sub> exposure and nervous system effects, and long-term PM<sub>2.5</sub> exposure and cancer. Because of remaining uncertainties and limitations in the evidence base, EPA determined a "suggestive of, but not sufficient to infer, a causal relationship" for long-term PM<sub>2.5</sub> exposure and reproductive and developmental effects (*i.e.*, male/female reproduction and fertility; pregnancy and birth outcomes), long- and short-term exposures and metabolic effects, and short-term exposure and nervous system effects.

As discussed extensively in the 2019 p.m. ISA and the Supplement, recent studies continue to support a "causal relationship" between short- and long-term PM<sub>2.5</sub> exposures and mortality.<sup>107</sup> <sup>108</sup> For short-term PM<sub>2.5</sub> exposure, multi-city studies, in combination with single- and multi-city studies evaluated in the 2009 p.m. ISA,

<sup>105</sup> U.S. EPA. Policy Assessment (PA) for the Reconsideration of the National Ambient Air Quality Standards for Particulate Matter (Final Report, 2022). U.S. Environmental Protection Agency, Washington, DC, EPA-452/R-22-004, 2022.

<sup>106</sup> U.S. EPA. (2009). Integrated Science Assessment for Particulate Matter (Final Report). U.S. Environmental Protection Agency, Washington, DC, EPA/600/R-08/139F.

<sup>107</sup> U.S. EPA. Integrated Science Assessment (ISA) for Particulate Matter (Final Report, 2019). U.S. Environmental Protection Agency, Washington, DC, EPA/600/R-19/188, 2019.

<sup>108</sup> U.S. EPA. Supplement to the 2019 Integrated Science Assessment for Particulate Matter (Final Report, 2022). U.S. Environmental Protection Agency, Washington, DC, EPA/635/R-22/028, 2022.

provide evidence of consistent, positive associations across studies conducted in different geographic locations, populations with different demographic characteristics, and studies using different exposure assignment techniques. Additionally, the consistent and coherent evidence across scientific disciplines for cardiovascular morbidity, particularly ischemic events and heart failure, and to a lesser degree for respiratory morbidity, including exacerbations of chronic obstructive pulmonary disease (COPD) and asthma, provide biological plausibility for cause-specific mortality and ultimately total mortality. Recent epidemiologic studies evaluated in the Supplement, including studies that employed alternative methods for confounder control, provide additional support to the evidence base that contributed to the 2019 p.m. ISA conclusion for short-term PM<sub>2.5</sub> exposure and mortality.

The 2019 p.m. ISA concluded a “causal relationship” between long-term PM<sub>2.5</sub> exposure and mortality. In addition to reanalyses and extensions of the American Cancer Society (ACS) and Harvard Six Cities (HSC) cohorts, multiple new cohort studies conducted in the United States and Canada consisting of people employed in a specific job (e.g., teacher, nurse), and that apply different exposure assignment techniques, provide evidence of positive associations between long-term PM<sub>2.5</sub> exposure and mortality. Biological plausibility for mortality due to long-term PM<sub>2.5</sub> exposure is provided by the coherence of effects across scientific disciplines for cardiovascular morbidity, particularly for coronary heart disease, stroke, and atherosclerosis, and for respiratory morbidity, particularly for the development of COPD. Additionally, recent studies provide evidence indicating that as long-term PM<sub>2.5</sub> concentrations decrease there is an increase in life expectancy. Recent cohort studies evaluated in the Supplement, as well as epidemiologic studies that conducted accountability analyses or employed alternative methods for confounder controls, support and extend the evidence base that contributed to the 2019 p.m. ISA conclusion for long-term PM<sub>2.5</sub> exposure and mortality.

A large body of studies examining both short- and long-term PM<sub>2.5</sub> exposure and cardiovascular effects builds on the evidence base evaluated in the 2009 p.m. ISA. The strongest evidence for cardiovascular effects in response to short-term PM<sub>2.5</sub> exposures is for ischemic heart disease and heart failure. The evidence for short-term

PM<sub>2.5</sub> exposure and cardiovascular effects is coherent across scientific disciplines and supports a continuum of effects ranging from subtle changes in indicators of cardiovascular health to serious clinical events, such as increased emergency department visits and hospital admissions due to cardiovascular disease and cardiovascular mortality. For long-term PM<sub>2.5</sub> exposure, there is strong and consistent epidemiologic evidence of a relationship with cardiovascular mortality. This evidence is supported by epidemiologic and animal toxicological studies demonstrating a range of cardiovascular effects including coronary heart disease, stroke, impaired heart function, and subclinical markers (e.g., coronary artery calcification, atherosclerotic plaque progression), which collectively provide coherence and biological plausibility. Recent epidemiologic studies evaluated in the Supplement, as well as studies that conducted accountability analyses or employed alternative methods for confounder control, support and extend the evidence base that contributed to the 2019 p.m. ISA conclusion for both short- and long-term PM<sub>2.5</sub> exposure and cardiovascular effects.

Studies evaluated in the 2019 p.m. ISA continue to provide evidence of a “likely to be causal relationship” between both short- and long-term PM<sub>2.5</sub> exposure and respiratory effects. Epidemiologic studies provide consistent evidence of a relationship between short-term PM<sub>2.5</sub> exposure and asthma exacerbation in children and COPD exacerbation in adults, as indicated by increases in emergency department visits and hospital admissions, which is supported by animal toxicological studies indicating worsening allergic airways disease and subclinical effects related to COPD. Epidemiologic studies also provide evidence of a relationship between short-term PM<sub>2.5</sub> exposure and respiratory mortality. However, there is inconsistent evidence of respiratory effects, specifically lung function declines and pulmonary inflammation, in controlled human exposure studies. With respect to long term PM<sub>2.5</sub> exposure, epidemiologic studies conducted in the United States and abroad provide evidence of a relationship with respiratory effects, including consistent changes in lung function and lung function growth rate, increased asthma incidence, asthma prevalence, and wheeze in children; acceleration of lung function decline in adults; and respiratory mortality. The epidemiologic evidence is supported by

animal toxicological studies, which provide coherence and biological plausibility for a range of effects including impaired lung development, decrements in lung function growth, and asthma development.

Since the 2009 p.m. ISA, a growing body of scientific evidence examined the relationship between long-term PM<sub>2.5</sub> exposure and nervous system effects, resulting for the first time in a causality determination for this health effects category of a “likely to be causal relationship.” The strongest evidence for effects on the nervous system come from epidemiologic studies that consistently report cognitive decrements and reductions in brain volume in adults. The effects observed in epidemiologic studies in adults are supported by animal toxicological studies demonstrating effects on the brain of adult animals including inflammation, morphologic changes, and neurodegeneration of specific regions of the brain. There is more limited evidence for neurodevelopmental effects in children, with some studies reporting positive associations with autism spectrum disorder and others providing limited evidence of an association with cognitive function. While there is some evidence from animal toxicological studies indicating effects on the brain (i.e., inflammatory and morphological changes) to support a biologically plausible pathway for neurodevelopmental effects, epidemiologic studies are limited due to their lack of control for potential confounding by copollutants, the small number of studies conducted, and uncertainty regarding critical exposure windows.

Building off the decades of research demonstrating mutagenicity, DNA damage, and other endpoints related to genotoxicity due to whole PM exposures, recent experimental and epidemiologic studies focusing specifically on PM<sub>2.5</sub> provide evidence of a relationship between long-term PM<sub>2.5</sub> exposure and cancer. Epidemiologic studies examining long-term PM<sub>2.5</sub> exposure and lung cancer incidence and mortality provide evidence of generally positive associations in cohort studies spanning different populations, locations, and exposure assignment techniques. Additionally, there is evidence of positive associations with lung cancer incidence and mortality in analyses limited to never smokers. In addition, experimental and epidemiologic studies of genotoxicity, epigenetic effects, carcinogenic potential, and that PM<sub>2.5</sub> exhibits several characteristics of

carcinogens provide biological plausibility for cancer development. This collective body of evidence contributed to the conclusion of a “likely to be causal relationship.”

For the additional health effects categories evaluated for PM<sub>2.5</sub> in the 2019 p.m. ISA, experimental and epidemiologic studies provide limited and/or inconsistent evidence of a relationship with PM<sub>2.5</sub> exposure. As a result, the 2019 p.m. ISA concluded that the evidence is “suggestive of, but not sufficient to infer a causal relationship” for short-term PM<sub>2.5</sub> exposure and metabolic effects and nervous system effects, and long-term PM<sub>2.5</sub> exposures and metabolic effects as well as reproductive and developmental effects.

In addition to evaluating the health effects attributed to short- and long-term exposure to PM<sub>2.5</sub>, the 2019 p.m. ISA also conducted an extensive evaluation as to whether specific components or sources of PM<sub>2.5</sub> are more strongly related with health effects than PM<sub>2.5</sub> mass. An evaluation of those studies resulted in the 2019 p.m. ISA concluding that “many PM<sub>2.5</sub> components and sources are associated with many health effects, and the evidence does not indicate that any one source or component is consistently more strongly related to health effects than PM<sub>2.5</sub> mass.”<sup>109</sup>

For both PM<sub>10–2.5</sub> and UFPs, for all health effects categories evaluated, the 2019 p.m. ISA concluded that the evidence was “suggestive of, but not sufficient to infer, a causal relationship” or “inadequate to determine the presence or absence of a causal relationship.” For PM<sub>10–2.5</sub>, although a Federal Reference Method (FRM) was instituted in 2011 to measure PM<sub>10–2.5</sub> concentrations nationally, the causality determinations reflect that the same uncertainty identified in the 2009 p.m. ISA persists with respect to the method used to estimate PM<sub>10–2.5</sub> concentrations in epidemiologic studies. Specifically, across epidemiologic studies, different approaches are used to estimate PM<sub>10–2.5</sub> concentrations (e.g., direct measurement of PM<sub>10–2.5</sub>, difference between PM<sub>10</sub> and PM<sub>2.5</sub> concentrations), and it remains unclear how well correlated PM<sub>10–2.5</sub> concentrations are both spatially and temporally across the different methods used.

For UFPs, which have often been defined as particles <0.1 μm, the uncertainty in the evidence for the health effect categories evaluated across

<sup>109</sup> U.S. EPA. Integrated Science Assessment (ISA) for Particulate Matter (Final Report, 2019). U.S. Environmental Protection Agency, Washington, DC, EPA/600/R-19/188, 2019.

experimental and epidemiologic studies reflects the inconsistency in the exposure metric used (i.e., particle number concentration, surface area concentration, mass concentration) as well as the size fractions examined. In epidemiologic studies the size fraction examined can vary depending on the monitor used and exposure metric, with some studies examining number count over the entire particle size range, while experimental studies that use a particle concentrator often examine particles up to 0.3 μm. Additionally, due to the lack of a monitoring network, there is limited information on the spatial and temporal variability of UFPs within the United States, as well as population exposures to UFPs, which adds uncertainty to epidemiologic study results.

The 2019 p.m. ISA cites extensive evidence indicating that “both the general population as well as specific populations and life stages are at risk for PM<sub>2.5</sub>-related health effects.”<sup>110</sup> For example, in support of its “causal” and “likely to be causal” determinations, the ISA cites substantial evidence for (1) PM-related mortality and cardiovascular effects in older adults; (2) PM-related cardiovascular effects in people with pre-existing cardiovascular disease; (3) PM-related respiratory effects in people with pre-existing respiratory disease, particularly asthma exacerbations in children; and (4) PM-related impairments in lung function growth and asthma development in children. The ISA additionally notes that stratified analyses (i.e., analyses that directly compare PM-related health effects across groups) provide strong evidence for racial and ethnic differences in PM<sub>2.5</sub> exposures and in the risk of PM<sub>2.5</sub>-related health effects, specifically within Hispanic and non-Hispanic Black populations, with some evidence of increased risk for populations of low socioeconomic status. Recent studies evaluated in the Supplement support the conclusion of the 2019 p.m. ISA with respect to disparities in both PM<sub>2.5</sub> exposure and health risk by race and ethnicity and provide additional support for disparities for populations of lower socioeconomic status.<sup>111</sup> Additionally, evidence spanning epidemiologic studies that conducted stratified analyses, experimental studies focusing on animal models of disease or

<sup>110</sup> U.S. EPA. Integrated Science Assessment (ISA) for Particulate Matter (Final Report, 2019). U.S. Environmental Protection Agency, Washington, DC, EPA/600/R-19/188, 2019.

<sup>111</sup> U.S. EPA. Supplement to the 2019 Integrated Science Assessment for Particulate Matter (Final Report, 2022). U.S. Environmental Protection Agency, Washington, DC, EPA/635/R-22/028, 2022.

individuals with pre-existing disease, dosimetry studies, as well as studies focusing on differential exposure suggest that populations with pre-existing cardiovascular or respiratory disease, populations that are overweight or obese, populations that have particular genetic variants, and current/former smokers could be at increased risk for adverse PM<sub>2.5</sub>-related health effects. The 2022 Policy Assessment for the review of the PM NAAQS also highlights that factors that may contribute to increased risk of PM<sub>2.5</sub>-related health effects include lifestyle (children and older adults), pre-existing diseases (cardiovascular disease and respiratory disease), race/ethnicity, and socioeconomic status.<sup>112</sup>

### 3. Nitrogen Oxides

The most recent review of the health effects of oxides of nitrogen completed by EPA can be found in the 2016 Integrated Science Assessment for Oxides of Nitrogen—Health Criteria (ISA for Oxides of Nitrogen).<sup>113</sup> The primary source of NO<sub>2</sub> is motor vehicle emissions, and ambient NO<sub>2</sub> concentrations tend to be highly correlated with other traffic-related pollutants. Thus, a key issue in characterizing the causality of NO<sub>2</sub>-health effect relationships consists of evaluating the extent to which studies supported an effect of NO<sub>2</sub> that is independent of other traffic-related pollutants. EPA concluded that the findings for asthma exacerbation integrated from epidemiologic and controlled human exposure studies provided evidence that is sufficient to infer a causal relationship between respiratory effects and short-term NO<sub>2</sub> exposure. The strongest evidence supporting an independent effect of NO<sub>2</sub> exposure comes from controlled human exposure studies demonstrating increased airway responsiveness in individuals with asthma following ambient-relevant NO<sub>2</sub> exposures. The coherence of this evidence with epidemiologic findings for asthma hospital admissions and emergency department visits as well as lung function decrements and increased pulmonary inflammation in children with asthma describe a plausible pathway by which NO<sub>2</sub> exposure can

<sup>112</sup> U.S. EPA. Policy Assessment (PA) for the Reconsideration of the National Ambient Air Quality Standards for Particulate Matter (Final Report, 2022). U.S. Environmental Protection Agency, Washington, DC, EPA-452/R-22-004, 2022, p. 3–53.

<sup>113</sup> U.S. EPA. Integrated Science Assessment for Oxides of Nitrogen—Health Criteria (2016 Final Report). U.S. Environmental Protection Agency, Washington, DC, EPA/600/R-15/068, 2016.



cause an asthma exacerbation. The 2016 ISA for Oxides of Nitrogen also concluded that there is likely to be a causal relationship between long-term NO<sub>2</sub> exposure and respiratory effects. This conclusion is based on new epidemiologic evidence for associations of NO<sub>2</sub> with asthma development in children combined with biological plausibility from experimental studies.

In evaluating a broader range of health effects, the 2016 ISA for Oxides of Nitrogen concluded that evidence is “suggestive of, but not sufficient to infer, a causal relationship” between short-term NO<sub>2</sub> exposure and cardiovascular effects and mortality and between long-term NO<sub>2</sub> exposure and cardiovascular effects and diabetes, birth outcomes, and cancer. In addition, the scientific evidence is inadequate (insufficient consistency of epidemiologic and toxicological evidence) to infer a causal relationship for long-term NO<sub>2</sub> exposure with fertility, reproduction, and pregnancy, as well as with postnatal development. A key uncertainty in understanding the relationship between these non-respiratory health effects and short- or long-term exposure to NO<sub>2</sub> is copollutant confounding, particularly by other roadway pollutants. The available evidence for non-respiratory health effects does not adequately address whether NO<sub>2</sub> has an independent effect or whether it primarily represents effects related to other or a mixture of traffic-related pollutants.

The 2016 ISA for Oxides of Nitrogen concluded that people with asthma, children, and older adults are at increased risk for NO<sub>2</sub>-related health effects. In these groups and lifestyles, NO<sub>2</sub> is consistently related to larger effects on outcomes related to asthma exacerbation, for which there is confidence in the relationship with NO<sub>2</sub> exposure.

#### 4. Carbon Monoxide

Information on the health effects of CO can be found in the January 2010 Integrated Science Assessment for Carbon Monoxide (CO ISA).<sup>114</sup> The CO ISA presents conclusions regarding the presence of causal relationships between CO exposure and categories of adverse health effects.<sup>115</sup> This section

<sup>114</sup> U.S. EPA, (2010). Integrated Science Assessment for Carbon Monoxide (Final Report). U.S. Environmental Protection Agency, Washington, DC, EPA/600/R-09/019F, 2010. <http://cfpub.epa.gov/ncea/cfm/recordisplay.cfm?deid=218686>.

<sup>115</sup> The ISA evaluates the health evidence associated with different health effects, assigning one of five “weight of evidence” determinations:

provides a summary of the health effects associated with exposure to ambient concentrations of CO, along with the CO ISA conclusions.<sup>116</sup>

Controlled human exposure studies of subjects with coronary artery disease show a decrease in the time to onset of exercise-induced angina (chest pain) and electrocardiogram changes following CO exposure. In addition, epidemiologic studies observed associations between short-term CO exposure and cardiovascular morbidity, particularly increased emergency room visits and hospital admissions for coronary heart disease (including ischemic heart disease, myocardial infarction, and angina). Some epidemiologic evidence is also available for increased hospital admissions and emergency room visits for congestive heart failure and cardiovascular disease as a whole. The CO ISA concludes that a causal relationship is likely to exist between short-term exposures to CO and cardiovascular morbidity. It also concludes that available data are inadequate to conclude that a causal relationship exists between long-term exposures to CO and cardiovascular morbidity.

Animal studies show various neurological effects with in-utero CO exposure. Controlled human exposure studies report central nervous system and behavioral effects following low-level CO exposures, although the findings have not been consistent across all studies. The CO ISA concludes that the evidence is suggestive of a causal relationship with both short- and long-term exposure to CO and central nervous system effects.

A number of studies cited in the CO ISA have evaluated the role of CO exposure in birth outcomes such as preterm birth or cardiac birth defects. There is limited epidemiologic evidence of a CO-induced effect on preterm births and birth defects, with weak evidence for a decrease in birth weight. Animal toxicological studies have found perinatal CO exposure to affect birth weight, as well as other developmental outcomes. The CO ISA concludes that the evidence is suggestive of a causal relationship between long-term

causal relationship, likely to be a causal relationship, suggestive of a causal relationship, inadequate to infer a causal relationship, and not likely to be a causal relationship. For definitions of these levels of evidence, please refer to Section 1.6 of the ISA.

<sup>116</sup> Personal exposure includes contributions from many sources, and in many different environments. Total personal exposure to CO includes both ambient and non-ambient components; and both components may contribute to adverse health effects.

exposures to CO and developmental effects and birth outcomes.

Epidemiologic studies provide evidence of associations between short-term CO concentrations and respiratory morbidity such as changes in pulmonary function, respiratory symptoms, and hospital admissions. A limited number of epidemiologic studies considered copollutants such as ozone, SO<sub>2</sub>, and PM in two-pollutant models and found that CO risk estimates were generally robust, although this limited evidence makes it difficult to disentangle effects attributed to CO itself from those of the larger complex air pollution mixture. Controlled human exposure studies have not extensively evaluated the effect of CO on respiratory morbidity. Animal studies at levels of 50–100 ppm CO show preliminary evidence of altered pulmonary vascular remodeling and oxidative injury. The CO ISA concludes that the evidence is suggestive of a causal relationship between short-term CO exposure and respiratory morbidity, and inadequate to conclude that a causal relationship exists between long-term exposure and respiratory morbidity.

Finally, the CO ISA concludes that the epidemiologic evidence is suggestive of a causal relationship between short-term concentrations of CO and mortality. Epidemiologic evidence suggests an association exists between short-term exposure to CO and mortality, but limited evidence is available to evaluate cause-specific mortality outcomes associated with CO exposure. In addition, the attenuation of CO risk estimates that was often observed in copollutant models contributes to the uncertainty as to whether CO is acting alone or as an indicator for other combustion-related pollutants. The CO ISA also concludes that there is not likely to be a causal relationship between relevant long-term exposures to CO and mortality.

#### 5. Diesel Exhaust

In EPA’s 2002 Diesel Health Assessment Document (Diesel HAD), exposure to diesel exhaust was classified as likely to be carcinogenic to humans by inhalation from environmental exposures, in accordance with the revised draft 1996/1999 EPA cancer guidelines.<sup>117 118</sup> A number of

<sup>117</sup> U.S. EPA. (1999). Guidelines for Carcinogen Risk Assessment. Review Draft. NCEA-F-0644, July, Washington, DC: U.S. EPA. Retrieved on March 19, 2009 from <http://cfpub.epa.gov/ncea/cfm/recordisplay.cfm?deid=54932>.

<sup>118</sup> U.S. EPA (2002). Health Assessment Document for Diesel Engine Exhaust. EPA/600/8-90/057F Office of research and Development, Washington, DC. Retrieved on March 17, 2009 from

other agencies (National Institute for Occupational Safety and Health, the International Agency for Research on Cancer, the World Health Organization, California EPA, and the U.S. Department of Health and Human Services) made similar hazard classifications prior to 2002. EPA also concluded in the 2002 Diesel HAD that it was not possible to calculate a cancer unit risk for diesel exhaust due to limitations in the exposure data for the occupational groups or the absence of a dose-response relationship.

In the absence of a cancer unit risk, the Diesel HAD sought to provide additional insight into the significance of the diesel exhaust cancer hazard by estimating possible ranges of risk that might be present in the population. An exploratory analysis was used to characterize a range of possible lung cancer risk. The outcome was that environmental risks of cancer from long-term diesel exhaust exposures could plausibly range from as low as  $10^{-5}$  to as high as  $10^{-3}$ . Because of uncertainties, the analysis acknowledged that the risks could be lower than  $10^{-5}$ , and a zero risk from diesel exhaust exposure could not be ruled out.

Noncancer health effects of acute and chronic exposure to diesel exhaust emissions are also of concern to EPA. EPA derived a diesel exhaust reference concentration (RfC) from consideration of four well-conducted chronic rat inhalation studies showing adverse pulmonary effects. The RfC is  $5 \mu\text{g}/\text{m}^3$  for diesel exhaust measured as diesel particulate matter. This RfC does not consider allergenic effects such as those associated with asthma or immunologic or the potential for cardiac effects. There was emerging evidence in 2002, discussed in the Diesel HAD, that exposure to diesel exhaust can exacerbate these effects, but the exposure-response data were lacking at that time to derive an RfC based on these then-emerging considerations. The Diesel HAD states, "With [diesel particulate matter] being a ubiquitous component of ambient PM, there is an uncertainty about the adequacy of the existing [diesel exhaust] noncancer database to identify all the pertinent [diesel exhaust]-caused noncancer health hazards." The Diesel HAD also notes "that acute exposure to [diesel exhaust] has been associated with irritation of the eye, nose, and throat, respiratory symptoms (cough and phlegm), and neurophysiological symptoms such as headache,

lightheadedness, nausea, vomiting, and numbness or tingling of the extremities." The Diesel HAD notes that the cancer and noncancer hazard conclusions applied to the general use of diesel engines then on the market and as cleaner engines replace a substantial number of existing ones, the applicability of the conclusions would need to be reevaluated.

It is important to note that the Diesel HAD also briefly summarizes health effects associated with ambient PM and discusses EPA's then-annual  $\text{PM}_{2.5}$  NAAQS of  $15 \mu\text{g}/\text{m}^3$ .<sup>119</sup> There is a large and extensive body of human data showing a wide spectrum of adverse health effects associated with exposure to ambient PM, of which diesel exhaust is an important component. The  $\text{PM}_{2.5}$  NAAQS is designed to provide protection from the noncancer health effects and premature mortality attributed to exposure to  $\text{PM}_{2.5}$ . The contribution of diesel PM to total ambient PM varies in different regions of the country and also, within a region, from one area to another. The contribution can be high in near-roadway environments, for example, or in other locations where diesel engine use is concentrated.

Since 2002, several new studies have been published which continue to report increased lung cancer risk associated with occupational exposure to diesel exhaust from older engines. Of particular note since 2011 are three new epidemiology studies that have examined lung cancer in occupational populations, for example, truck drivers, underground nonmetal miners, and other diesel motor-related occupations. These studies reported increased risk of lung cancer with exposure to diesel exhaust with evidence of positive exposure-response relationships to varying degrees.<sup>120 121 122</sup> These newer studies (along with others that have appeared in the scientific literature) add to the evidence EPA evaluated in the 2002 Diesel HAD and further reinforce the concern that diesel exhaust exposure likely poses a lung cancer

hazard. The findings from these newer studies do not necessarily apply to newer technology diesel engines (*i.e.*, heavy-duty highway engines from 2007 and later model years) since the newer engines have large reductions in the emission constituents compared to older technology diesel engines.

In light of the growing body of scientific literature evaluating the health effects of exposure to diesel exhaust, in June 2012 the World Health Organization's International Agency for Research on Cancer (IARC), a recognized international authority on the carcinogenic potential of chemicals and other agents, evaluated the full range of cancer-related health effects data for diesel engine exhaust. IARC concluded that diesel exhaust should be regarded as "carcinogenic to humans."<sup>123</sup> This designation was an update from its 1988 evaluation that considered the evidence to be indicative of a "probable human carcinogen."

## 6. Air Toxics

Heavy-duty engine emissions contribute to ambient levels of air toxics that are known or suspected human or animal carcinogens, or that have noncancer health effects. These compounds include, but are not limited to, benzene, formaldehyde, acetaldehyde, and naphthalene. These compounds were identified as national or regional cancer risk drivers or contributors in the 2018 AirToxScreen Assessment and have significant inventory contributions from mobile sources.<sup>124 125</sup> Chapter 4 of the RIA includes additional information on the health effects associated with exposure to each of these pollutants.

## 7. Exposure and Health Effects Associated With Traffic

Locations in close proximity to major roadways generally have elevated concentrations of many air pollutants emitted from motor vehicles. Hundreds of studies have been published in peer-reviewed journals, concluding that concentrations of CO, CO<sub>2</sub>, NO, NO<sub>2</sub>, benzene, aldehydes, PM, black carbon, and many other compounds are elevated in ambient air within approximately

<sup>119</sup> See Section II.A.2 for discussion of the current  $\text{PM}_{2.5}$  NAAQS standard.

<sup>120</sup> Garshick, Eric, Francine Laden, Jaime E. Hart, Mary E. Davis, Ellen A. Eisen, and Thomas J. Smith. 2012. Lung cancer and elemental carbon exposure in trucking industry workers. *Environmental Health Perspectives* 120(9): 1301–1306.

<sup>121</sup> Silverman, D.T., Samanic, C.M., Lubin, J.H., Blair, A.E., Stewart, P.A., Vermeulen, R., & Attfield, M.D. (2012). The diesel exhaust in miners study: a nested case-control study of lung cancer and diesel exhaust. *Journal of the National Cancer Institute*.

<sup>122</sup> Olsson, Ann C., et al. "Exposure to diesel motor exhaust and lung cancer risk in a pooled analysis from case-control studies in Europe and Canada." *American Journal of Respiratory and Critical Care Medicine* 183.7 (2011): 941–948.

<sup>123</sup> IARC [International Agency for Research on Cancer]. (2013). Diesel and gasoline engine exhausts and some nitroarenes. IARC Monographs Volume 105. [Online at <http://monographs.iarc.fr/ENG/Monographs/vol105/index.php>].

<sup>124</sup> U.S. EPA (2022) Technical Support Document EPA Air Toxics Screening Assessment. 2017AirToxScreen TSD. [https://www.epa.gov/system/files/documents/2022-03/airtoxscreen\\_2017tsd.pdf](https://www.epa.gov/system/files/documents/2022-03/airtoxscreen_2017tsd.pdf).

<sup>125</sup> U.S. EPA (2022) 2018 AirToxScreen Risk Drivers. <https://www.epa.gov/AirToxScreen/airtoxscreen-risk-drivers>.

300–600 meters (about 1,000–2,000 feet) of major roadways. The highest concentrations of most pollutants emitted directly by motor vehicles are found at locations within 50 meters (about 165 feet) of the edge of a roadway's traffic lanes.

A large-scale review of air quality measurements in the vicinity of major roadways between 1978 and 2008 concluded that the pollutants with the steepest concentration gradients in vicinities of roadways were CO, UFPs, metals, elemental carbon (EC), NO, NO<sub>x</sub>, and several VOCs.<sup>126</sup> These pollutants showed a large reduction in concentrations within 100 meters downwind of the roadway. Pollutants that showed more gradual reductions with distance from roadways included benzene, NO<sub>2</sub>, PM<sub>2.5</sub>, and PM<sub>10</sub>. In reviewing the literature, Karner et al., (2010) reported that results varied based on the method of statistical analysis used to determine the gradient in pollutant concentration. More recent studies continue to show significant concentration gradients of traffic-related air pollution around major roads.<sup>127 128 129 130 131 132 133 134 135 136</sup>

<sup>126</sup> Karner, A.A.; Eisinger, D.S.; Niemeier, D.A. (2010). Near-roadway air quality: synthesizing the findings from real-world data. *Environ Sci Technol* 44: 5334–5344.

<sup>127</sup> McDonald, B.C.; McBride, Z.C.; Martin, E.W.; Harley, R.A. (2014) High-resolution mapping of motor vehicle carbon dioxide emissions. *J. Geophys. Res. Atmos.*, 119, 5283–5298, doi:10.1002/2013JD021219.

<sup>128</sup> Kimbrough, S.; Baldauf, R.W.; Hagler, G.S.W.; Shores, R.C.; Mitchell, W.; Whitaker, D.A.; Croghan, C.W.; Vallero, D.A. (2013) Long-term continuous measurement of near-road air pollution in Las Vegas: seasonal variability in traffic emissions impact on air quality. *Air Qual Atmos Health* 6: 295–305. DOI 10.1007/s11869-012-0171-x.

<sup>129</sup> Kimbrough, S.; Palma, T.; Baldauf, R.W. (2014) Analysis of mobile source air toxics (MSATs)—Near-road VOC and carbonyl concentrations. *Journal of the Air & Waste Management Association*, 64:3, 349–359, DOI: 10.1080/10962247.2013.863814.

<sup>130</sup> Kimbrough, S.; Owen, R.C.; Snyder, M.; Richmond-Bryant, J. (2017) NO to NO<sub>2</sub> Conversion Rate Analysis and Implications for Dispersion Model Chemistry Methods using Las Vegas, Nevada Near-Road Field Measurements. *Atmos Environ* 165: 23–24.

<sup>131</sup> Hilker, N.; Wang, J.W.; Jong, C.-H.; Healy, R.M.; Sofowote, U.; Deboz, J.; Su, Y.; Noble, M.; Munoz, A.; Doerkson, G.; White, L.; Audette, C.; Herod, D.; Brook, J.R.; Evans, G.J. (2019) Traffic-related air pollution near roadways: discerning local impacts from background. *Atmos. Meas. Tech.*, 12, 5247–5261. <https://doi.org/10.5194/amt-12-5247-2019>.

<sup>132</sup> Grivas, G.; Stavroulas, I.; Liakakou, E.; Kaskaoutis, D.G.; Bougiatioti, A.; Paraskevopoulou, D.; Gerasopoulos, E.; Mihalopoulos, N. (2019) Measuring the spatial variability of black carbon in Athens during wintertime. *Air Quality, Atmosphere & Health* (2019) 12:1405–1417. <https://doi.org/10.1007/s11869-019-00756-y>.

<sup>133</sup> Apte, J.S.; Messier, K.P.; Gani, S.; Brauer, M.; Kirchstetter, T.W.; Lunden, M.M.; Marshall, J.D.; Portier, C.J.; Vermeulen, R.C.H.; Hamburg, S.P.

There is evidence that EPA's regulations for vehicles have lowered the near-road concentrations and gradients.<sup>137</sup>

Starting in 2010, EPA required through the NAAQS process that air quality monitors be placed near high-traffic roadways for determining concentrations of CO, NO<sub>2</sub>, and PM<sub>2.5</sub> (in addition to those existing monitors located in neighborhoods and other locations farther away from pollution sources). The monitoring data for NO<sub>2</sub> indicate that in urban areas, monitors near roadways often report the highest concentrations of NO<sub>2</sub>.<sup>138</sup> More recent studies of traffic-related air pollutants continue to report sharp gradients around roadways, particularly within several hundred meters.<sup>139 140</sup>

For pollutants with relatively high background concentrations relative to near-road concentrations, detecting concentration gradients can be difficult. For example, many carbonyls have high background concentrations as a result of photochemical breakdown of precursors from many different organic compounds. However, several studies

(2017) High-Resolution Air Pollution Mapping with Google Street View Cars: Exploiting Big Data. *Environ Sci Technol* 51: 6999–7008. <https://doi.org/10.1021/acs.est.7b00891>.

<sup>134</sup> Dabek-Zlotorzynska, E.; Celso, V.; Ding, L.; Herod, D.; Jeong, C.-H.; Evans, G.; Hilker, N. (2019) Characteristics and sources of PM<sub>2.5</sub> and reactive gases near roadways in two metropolitan areas in Canada. *Atmos Environ* 218: 116980. <https://doi.org/10.1016/j.atmosenv.2019.116980>.

<sup>135</sup> Apte, J.S.; Messier, K.R.; Gani, S.; et al. (2017) High-resolution air pollution mapping with Google Street View cars: exploiting big data. *Environ Sci Technol* 51: 6999–7018, [Online at <https://doi.org/10.1021/acs.est.7b00891>].

<sup>136</sup> Gu, P.; Li, H.Z.; Ye, Q.; et al. (2018) Intercity variability of particulate matter is driven by carbonaceous sources and correlated with land-use variables. *Environ Sci Technol* 52: 11545–11554. [Online at <http://dx.doi.org/10.1021/acs.est.8b03833>].

<sup>137</sup> Sarnat, J.A.; Russell, A.; Liang, D.; Moutinho, J.L.; Golan, R.; Weber, R.; Gao, D.; Sarnat, S.; Chang, H.H.; Greenwald, R.; Yu, T. (2018) Developing Multipollutant Exposure Indicators of Traffic Pollution: The Dorm Room Inhalation to Vehicle Emissions (DRIVE) Study. Health Effects Institute Research Report Number 196. [Online at: <https://www.healtheffects.org/publication/developing-multipollutant-exposure-indicators-traffic-pollution-dorm-room-inhalation>].

<sup>138</sup> Gantt, B.; Owen, R.C.; Watkins, N. (2021) Characterizing nitrogen oxides and fine particulate matter near major highways in the United States using the National Near-road Monitoring Network. *Environ Sci Technol* 55: 2831–2838. [Online at <https://doi.org/10.1021/acs.est.0c05851>].

<sup>139</sup> Apte, J.S.; Messier, K.R.; Gani, S.; et al. (2017) High-resolution air pollution mapping with Google Street View cars: exploiting big data. *Environ Sci Technol* 51: 6999–7018, [Online at <https://doi.org/10.1021/acs.est.7b00891>].

<sup>140</sup> Gu, P.; Li, H.Z.; Ye, Q.; et al. (2018) Intercity variability of particulate matter is driven by carbonaceous sources and correlated with land-use variables. *Environ Sci Technol* 52: 11545–11554. [Online at <http://dx.doi.org/10.1021/acs.est.8b03833>].

have measured carbonyls in multiple weather conditions and found higher concentrations of many carbonyls downwind of roadways.<sup>141 142</sup> These findings suggest a substantial roadway source of these carbonyls.

In the past 30 years, many studies have been published with results reporting that populations who live, work, or go to school near high-traffic roadways experience higher rates of numerous adverse health effects, compared to populations far away from major roads.<sup>143</sup> In addition, numerous studies have found adverse health effects associated with spending time in traffic, such as commuting or walking along high-traffic roadways, including studies among children.<sup>144 145 146 147</sup> The health outcomes with the strongest evidence linking them with traffic-associated air pollutants are respiratory effects, particularly in asthmatic children, and cardiovascular effects. Commenters on the NPRM stressed the importance of consideration of the impacts of traffic-related air pollution, especially NO<sub>x</sub>, on children's health.

Numerous reviews of this body of health literature have been published. In a 2022 final report, an expert panel of the Health Effects Institute (HEI) employed a systematic review focusing on selected health endpoints related to exposure to traffic-related air pollution.<sup>148</sup> The HEI panel concluded

<sup>141</sup> Liu, W.; Zhang, J.; Kwon, J.L.; et al. (2006). Concentrations and source characteristics of airborne carbonyl compounds measured outside urban residences. *J Air Waste Manage Assoc* 56: 1196–1204.

<sup>142</sup> Cahill, T.M.; Charles, M.J.; Seaman, V.Y. (2010). Development and application of a sensitive method to determine concentrations of acrolein and other carbonyls in ambient air. *Health Effects Institute Research Report* 149. Available at <https://www.healtheffects.org/system/files/Cahill149.pdf>.

<sup>143</sup> In the widely-used PubMed database of health publications, between January 1, 1990 and December 31, 2021, 1,979 publications contained the keywords “traffic, pollution, epidemiology,” with approximately half the studies published after 2015.

<sup>144</sup> Laden, F.; Hart, J.E.; Smith, T.J.; Davis, M.E.; Garshick, E. (2007) Cause-specific mortality in the unionized U.S. trucking industry. *Environmental Health Perspect* 115:1192–1196.

<sup>145</sup> Peters, A.; von Klot, S.; Heier, M.; Trentinaglia, I.; Hörmann, A.; Wichmann, H.E.; Löwel, H. (2004) Exposure to traffic and the onset of myocardial infarction. *New England J Med* 351: 1721–1730.

<sup>146</sup> Zanobetti, A.; Stone, P.H.; Spelzer, F.E.; Schwartz, J.D.; Coull, B.A.; Suh, H.H.; Nearing, B.D.; Mittleman, M.A.; Verrier, R.L.; Gold, D.R. (2009) T-wave alternans, air pollution and traffic in high-risk subjects. *Am J Cardiol* 104: 665–670.

<sup>147</sup> Adar, S.; Adamkiewicz, G.; Gold, D.R.; Schwartz, J.; Coull, B.A.; Suh, H.H. (2007) Ambient and microenvironmental particles and exhaled nitric oxide before and after a group bus trip. *Environ Health Perspect* 115: 507–512.

<sup>148</sup> HEI Panel on the Health Effects of Long-Term Exposure to Traffic-Related Air Pollution (2022)

that there was a high level of confidence in evidence between long-term exposure to traffic-related air pollution and health effects in adults, including all-cause, circulatory, and ischemic heart disease mortality.<sup>149</sup> The panel also found that there is a moderate-to-high level of confidence in evidence of associations with asthma onset and acute respiratory infections in children and lung cancer and asthma onset in adults. This report follows on an earlier expert review published by HEI in 2010, where it found strongest evidence for asthma-related traffic impacts. Other literature reviews have been published with conclusions generally similar to the HEI panels'.<sup>150 151 152 153</sup> Additionally, in 2014, researchers from the U.S. Centers for Disease Control and Prevention (CDC) published a systematic review and meta-analysis of studies evaluating the risk of childhood leukemia associated with traffic exposure and reported positive associations between “postnatal” proximity to traffic and leukemia risks, but no such association for “prenatal” exposures.<sup>154</sup> The U.S. Department of Health and Human Services’ National Toxicology Program (NTP) published a monograph including a systematic review of traffic-related air pollution and its impacts on hypertensive disorders of pregnancy. The NTP concluded that exposure to traffic-related air pollution is “presumed to be a hazard to pregnant

Systematic review and meta-analysis of selected health effects of long-term exposure to traffic-related air pollution. Health Effects Institute Special Report 23. [Online at [https://www.healtheffects.org/system/files/hei-special-report-23\\_1.pdf](https://www.healtheffects.org/system/files/hei-special-report-23_1.pdf).] This more recent review focused on health outcomes related to birth effects, respiratory effects, cardiometabolic effects, and mortality.

<sup>149</sup> Boogaard, H.; Patton, A.P.; Atkinson, R.W.; Brook, J.R.; Chang, H.H.; Crouse, D.L.; Fussell, J.C.; Hoek, G.; Hoffman, B.; Kappeler, R.; Kutlar Joss, M.; Ondras, M.; Sagiv, S.K.; Somoli, E.; Shaikh, R.; Szpiro, A.A.; Van Vliet E.D.S.; Vinneau, D.; Weuve, J.; Lurmann, F.W.; Forastiere, F. (2022) Long-term exposure to traffic-related air pollution and selected health outcomes: a systematic review and meta-analysis. *Environ Intl* 164: 107262. [Online at <https://doi.org/10.1016/j.envint.2022.107262>].

<sup>150</sup> Boothe, V.L.; Shendell, D.G. (2008). Potential health effects associated with residential proximity to freeways and primary roads: review of scientific literature, 1999–2006. *J Environ Health* 70: 33–41.

<sup>151</sup> Salam, M.T.; Islam, T.; Gilliland, F.D. (2008). Recent evidence for adverse effects of residential proximity to traffic sources on asthma. *Curr Opin Pulm Med* 14: 3–8.

<sup>152</sup> Sun, X.; Zhang, S.; Ma, X. (2014) No association between traffic density and risk of childhood leukemia: a meta-analysis. *Asia Pac J Cancer Prev* 15: 5229–5232.

<sup>153</sup> Raaschou-Nielsen, O.; Reynolds, P. (2006). Air pollution and childhood cancer: a review of the epidemiological literature. *Int J Cancer* 118: 2920–9.

<sup>154</sup> Boothe, V.L.; Boehmer, T.K.; Wendel, A.M.; Yip, F.Y. (2014) Residential traffic exposure and childhood leukemia: a systematic review and meta-analysis. *Am J Prev Med* 46: 413–422.

women” for developing hypertensive disorders of pregnancy.<sup>155</sup>

Health outcomes with few publications suggest the possibility of other effects still lacking sufficient evidence to draw definitive conclusions. Among these outcomes with a small number of positive studies are neurological impacts (e.g., autism and reduced cognitive function) and reproductive outcomes (e.g., preterm birth, low birth weight).<sup>156 157 158 159 160</sup>

In addition to health outcomes, particularly cardiopulmonary effects, conclusions of numerous studies suggest mechanisms by which traffic-related air pollution affects health. For example, numerous studies indicate that near-roadway exposures may increase systemic inflammation, affecting organ systems, including blood vessels and lungs.<sup>161 162 163 164</sup> Additionally, long-term exposures in near-road environments have been associated with inflammation-associated conditions, such as atherosclerosis and asthma.<sup>165 166 167</sup>

<sup>155</sup> National Toxicology Program (2019) NTP Monograph on the Systematic Review of Traffic-related Air Pollution and Hypertensive Disorders of Pregnancy. NTP Monograph 7. [https://ntp.niehs.nih.gov/ntp/ohat/trap/mgraph/trap\\_final\\_508.pdf](https://ntp.niehs.nih.gov/ntp/ohat/trap/mgraph/trap_final_508.pdf).

<sup>156</sup> Volk, H.E.; Hertz-Picciotto, I.; Delwiche, L.; et al. (2011). Residential proximity to freeways and autism in the CHARGE study. *Environ Health Perspect* 119: 873–877.

<sup>157</sup> Franco-Suglia, S.; Gryparis, A.; Wright, R.O.; et al. (2007). Association of black carbon with cognition among children in a prospective birth cohort study. *Am J Epidemiol*. doi: 10.1093/aje/kwm308. [Online at <http://dx.doi.org/>].

<sup>158</sup> Power, M.C.; Weisskopf, M.G.; Alexeef, S.E.; et al. (2011). Traffic-related air pollution and cognitive function in a cohort of older men. *Environ Health Perspect* 2011: 682–687.

<sup>159</sup> Wu, J.; Wilhelm, M.; Chung, J.; et al. (2011). Comparing exposure assessment methods for traffic-related air pollution in and adverse pregnancy outcome study. *Environ Res* 111: 685–692.

<sup>160</sup> Stenson, C.; Wheeler, A.J.; Carver, A.; et al. (2021) The impact of traffic-related air pollution on child and adolescent academic performance: a systematic review. *Environ Intl* 155: 106696 [Online at <https://doi.org/10.1016/j.envint.2021.106696>].

<sup>161</sup> Riediker, M. (2007). Cardiovascular effects of fine particulate matter components in highway patrol officers. *Inhal Toxicol* 19: 99–105. doi: 10.1080/08958370701495238.

<sup>162</sup> Alexeef, S.E.; Coull, B.A.; Gryparis, A.; et al. (2011). Medium-term exposure to traffic-related air pollution and markers of inflammation and endothelial function. *Environ Health Perspect* 119: 481–486. doi:10.1289/ehp.1002560.

<sup>163</sup> Eckel, S.P.; Berhane, K.; Salam, M.T.; et al. (2011). Residential Traffic-related pollution exposure and exhaled nitric oxide in the Children’s Health Study. *Environ Health Perspect*. doi:10.1289/ehp.1103516.

<sup>164</sup> Zhang, J.; McCreanor, J.E.; Cullinan, P.; et al. (2009). Health effects of real-world exposure diesel exhaust in persons with asthma. *Res Rep Health Effects Inst* 138. [Online at <http://www.healtheffects.org/>].

<sup>165</sup> Adar, S.D.; Klein, R.; Klein, E.K.; et al. (2010). Air pollution and the microvasculature: a cross-

Several studies suggest that some factors may increase susceptibility to the effects of traffic-associated air pollution. Several studies have found stronger adverse health associations in children experiencing chronic social stress, such as in violent neighborhoods or in homes with low incomes or high family stress.<sup>168 169 170 171</sup>

The risks associated with residence, workplace, or schools near major roads are of potentially high public health significance due to the large population in such locations. The 2013 U.S. Census Bureau’s American Housing Survey (AHS) was the last AHS that included whether housing units were within 300 feet of an “airport, railroad, or highway with four or more lanes.”<sup>172</sup> The 2013 survey reports that 17.3 million housing units, or 13 percent of all housing units in the United States, were in such areas. Assuming that populations and housing units are in the same locations, this corresponds to a population of more than 41 million U.S. residents in close proximity to high-traffic roadways or other transportation sources. According to the Central Intelligence Agency’s World Factbook, based on data collected between 2012–2014, the United States had 6,586,610 km of roadways, 293,564 km of railways, and 13,513 airports. As such, highways represent the overwhelming majority of transportation facilities described by this factor in the AHS.

sectional assessment of in vivo retinal images in the population-based Multi-Ethnic Study of Atherosclerosis. *PLoS Med* 7(11): E1000372. doi:10.1371/journal.pmed.1000372. Available at <http://dx.doi.org/>.

<sup>166</sup> Kan, H.; Heiss, G.; Rose, K.M.; et al. (2008). Prospective analysis of traffic exposure as a risk factor for incident coronary heart disease: The Atherosclerosis Risk in Communities (ARIC) study. *Environ Health Perspect* 116: 1463–1468. doi:10.1289/ehp.11290. Available at <http://dx.doi.org/>.

<sup>167</sup> McConnell, R.; Islam, T.; Shankardass, K.; et al. (2010). Childhood incident asthma and traffic-related air pollution at home and school. *Environ Health Perspect* 1021–1026.

<sup>168</sup> Islam, T.; Urban, R.; Gauderman, W.J.; et al. (2011). Parental stress increases the detrimental effect of traffic exposure on children’s lung function. *Am J Respir Crit Care Med*.

<sup>169</sup> Clougherty, J.E.; Levy, J.I.; Kubzansky, L.D.; et al. (2007). Synergistic effects of traffic-related air pollution and exposure to violence on urban asthma etiology. *Environ Health Perspect* 115: 1140–1146.

<sup>170</sup> Chen, E.; Schrier, H.M.; Strunk, R.C.; et al. (2008). Chronic traffic-related air pollution and stress interact to predict biologic and clinical outcomes in asthma. *Environ Health Perspect* 116: 970–5.

<sup>171</sup> Long, D.; Lewis, D.; Langpap, C. (2021) Negative traffic externalities and infant health: the role of income heterogeneity and residential sorting. *Environ and Resource Econ* 80: 637–674. [Online at <https://doi.org/10.1007/s10640-021-00601-w>].

<sup>172</sup> The variable was known as “ETTRANS” in the questions about the neighborhood.

EPA also conducted a study to estimate the number of people living near truck freight routes in the United States.<sup>173</sup> Based on a population analysis using the U.S. Department of Transportation's (USDOT) Freight Analysis Framework 4 (FAF4) and population data from the 2010 decennial census, an estimated 72 million people live within 200 meters of these freight routes.<sup>174</sup> In addition, relative to the rest of the population, people of color and those with lower incomes are more likely to live near FAF4 truck routes. They are also more likely to live in metropolitan areas. The EPA's Exposure Factor Handbook also indicates that, on average, Americans spend more than an hour traveling each day, bringing nearly all residents into a high-exposure microenvironment for part of the day.<sup>176</sup>

As described in Section VII.H.1, we estimate that about 10 million students attend schools within 200 meters of major roads.<sup>177</sup> Research into the impact of traffic-related air pollution on school performance is tentative. A review of this literature found some evidence that children exposed to higher levels of traffic-related air pollution show poorer academic performance than those exposed to lower levels of traffic-related air pollution.<sup>178</sup> However, this evidence was judged to be weak due to limitations in the assessment methods.

While near-roadway studies focus on residents near roads or others spending considerable time near major roads, the

<sup>173</sup> U.S. EPA (2021). Estimation of Population Size and Demographic Characteristics among People Living Near Truck Routes in the Conterminous United States. Memorandum to the Docket.

<sup>174</sup> FAF4 is a model from the USDOT's Bureau of Transportation Statistics (BTS) and Federal Highway Administration (FHWA), which provides data associated with freight movement in the U.S. It includes data from the 2012 Commodity Flow Survey (CFS), the Census Bureau on international trade, as well as data associated with construction, agriculture, utilities, warehouses, and other industries. FAF4 estimates the modal choices for moving goods by trucks, trains, boats, and other types of freight modes. It includes traffic assignments, including truck flows on a network of truck routes. [https://ops.fhwa.dot.gov/freight/freight\\_analysis/faf/](https://ops.fhwa.dot.gov/freight/freight_analysis/faf/).

<sup>175</sup> The same analysis estimated the population living within 100 meters of a FAF4 truck route is 41 million.

<sup>176</sup> EPA. (2011) Exposure Factors Handbook: 2011 Edition. Chapter 16. Online at <https://www.epa.gov/sites/production/files/2015-09/documents/efh-chapter16.pdf>.

<sup>177</sup> Pedde, M.; Bailey, C. (2011) Identification of Schools within 200 Meters of U.S. Primary and Secondary Roads. Memorandum to the docket.

<sup>178</sup> Stenson, C.; Wheeler, A.J.; Carver, A.; et al. (2021) The impact of traffic-related air pollution on child and adolescent academic performance: a systematic review. *Environ Intl* 155: 106696. [Online at <https://doi.org/10.1016/j.envint.2021.106696>].

duration of commuting results in another important contributor to overall exposure to traffic-related air pollution. Studies of health that address time spent in transit have found evidence of elevated risk of cardiac impacts.<sup>179</sup> Studies have also found that school bus emissions can increase student exposures to diesel-related air pollutants, and that programs that reduce school bus emissions may improve health and reduce school absenteeism.<sup>182</sup>

### C. Environmental Effects Associated With Exposure to Pollutants Impacted by This Rule

This section discusses the environmental effects associated with pollutants affected by this rule, specifically PM, ozone, NO<sub>x</sub> and air toxics.

#### 1. Visibility

Visibility can be defined as the degree to which the atmosphere is transparent to visible light.<sup>186</sup> Visibility impairment is caused by light scattering and absorption by suspended particles and gases. It is dominated by contributions from suspended particles except under pristine conditions. Visibility is important because it has direct significance to people's enjoyment of daily activities in all parts of the country. Individuals value good

<sup>179</sup> Riediker, M.; Cascio, W.E.; Griggs, T.R.; et al. (2004) Particulate matter exposure in cars is associated with cardiovascular effects in healthy young men. *Am J Respir Crit Care Med* 169. [Online at <https://doi.org/10.1164/rccm.200310-1463OC>].

<sup>180</sup> Peters, A.; von Klot, S.; Heier, M.; et al. (2004) Exposure to traffic and the onset of myocardial infarction. *New Engl J Med* 1721-1730. [Online at <https://doi.org/10.1056/NEJMoa040203>].

<sup>181</sup> Adar, S.D.; Gold, D.R.; Coull, B.A.; (2007) Focused exposure to airborne traffic particles and heart rate variability in the elderly. *Epidemiology* 18: 95-103 [Online at: <https://doi.org/10.1097/01.ede.0000249409.81050.46>].

<sup>182</sup> Sabin, L.; Behrentz, E.; Winer, A.M.; et al. Characterizing the range of children's air pollutant exposure during school bus commutes. *J Expo Anal Environ Epidemiol* 15: 377-387. [Online at <https://doi.org/10.1038/sj.jea.7500414>].

<sup>183</sup> Li, C.; N, Q.; Ryan, P.H.; School bus pollution and changes in the air quality at schools: a case study. *J Environ Monit* 11: 1037-1042. [<https://doi.org/10.1039/b819458k>].

<sup>184</sup> Austin, W.; Heutel, G.; Kreisman, D. (2019) School bus emissions, student health and academic performance. *Econ Edu Rev* 70: 108-12.

<sup>185</sup> Adar, S.D.; D. Souza, J.; Sheppard, L.; Adopting clean fuels and technologies on school buses. Pollution and health impacts in children. *Am J Respir Crit Care Med* 191. [Online at <http://doi.org/10.1164/rccm.201410-1924OC>].

<sup>186</sup> National Research Council. (1993). Protecting Visibility in National Parks and Wilderness Areas. National Academy of Sciences Committee on Haze in National Parks and Wilderness Areas. National Academy Press, Washington, DC. This book can be viewed on the National Academy Press website at <https://www.nap.edu/catalog/2097/protecting-visibility-in-national-parks-and-wilderness-areas>.

visibility for the well-being it provides them directly, where they live and work, and in places where they enjoy recreational opportunities. Visibility is also highly valued in significant natural areas, such as national parks and wilderness areas, and special emphasis is given to protecting visibility in these areas. For more information on visibility see the final 2019 p.m. ISA.<sup>187</sup>

EPA is working to address visibility impairment. Reductions in air pollution from implementation of various programs associated with the Clean Air Act Amendments of 1990 provisions have resulted in substantial improvements in visibility and will continue to do so in the future. Nationally, because trends in haze are closely associated with trends in particulate sulfate and nitrate due to the relationship between their concentration and light extinction, visibility trends have improved as emissions of SO<sub>2</sub> and NO<sub>x</sub> have decreased over time due to air pollution regulations such as the Acid Rain Program.<sup>188</sup> However between 1990 and 2018, in the western part of the country, changes in total light extinction were smaller, and the contribution of particulate organic matter to atmospheric light extinction was increasing due to increasing wildfire emissions.<sup>189</sup>

In the Clean Air Act Amendments of 1977, Congress recognized visibility's value to society by establishing a national goal to protect national parks and wilderness areas from visibility impairment caused by manmade pollution.<sup>190</sup> In 1999, EPA finalized the regional haze program to protect the visibility in Mandatory Class I Federal areas.<sup>191</sup> There are 156 national parks, forests and wilderness areas categorized as Mandatory Class I Federal areas.<sup>192</sup> These areas are defined in CAA section 162 as those national parks exceeding 6,000 acres, wilderness areas, and memorial parks exceeding 5,000 acres, and all international parks which were in existence on August 7, 1977.

<sup>187</sup> U.S. EPA. Integrated Science Assessment (ISA) for Particulate Matter (Final Report, 2019). U.S. Environmental Protection Agency, Washington, DC, EPA/600/R-19/188, 2019.

<sup>188</sup> U.S. EPA. Integrated Science Assessment (ISA) for Particulate Matter (Final Report, 2019). U.S. Environmental Protection Agency, Washington, DC, EPA/600/R-19/188, 2019.

<sup>189</sup> Hand, J.L.; Prenni, A.J.; Copeland, S.; Schichtel, B.A.; Malm, W.C. (2020). Thirty years of the Clean Air Act Amendments: Impacts on haze in remote regions of the United States (1990-2018). *Atmos Environ* 243: 117865.

<sup>190</sup> See CAA section 169(a).

<sup>191</sup> 64 FR 35714, July 1, 1999.

<sup>192</sup> 62 FR 38680-38681, July 18, 1997.

EPA has also concluded that PM<sub>2.5</sub> causes adverse effects on visibility in other areas that are not targeted by the Regional Haze Rule, such as urban areas, depending on PM<sub>2.5</sub> concentrations and other factors such as dry chemical composition and relative humidity (*i.e.*, an indicator of the water composition of the particles). The secondary (welfare-based) PM NAAQS provide protection against visibility effects. In recent PM NAAQS reviews, EPA evaluated a target level of protection for visibility impairment that is expected to be met through attainment of the existing secondary PM standards.

## 2. Plant and Ecosystem Effects of Ozone

The welfare effects of ozone include effects on ecosystems, which can be observed across a variety of scales, *i.e.*, subcellular, cellular, leaf, whole plant, population and ecosystem. When ozone effects that begin at small spatial scales, such as the leaf of an individual plant, occur at sufficient magnitudes (or to a sufficient degree), they can result in effects being propagated along a continuum to higher and higher levels of biological organization. For example, effects at the individual plant level, such as altered rates of leaf gas exchange, growth and reproduction, can, when widespread, result in broad changes in ecosystems, such as productivity, carbon storage, water cycling, nutrient cycling, and community composition.

Ozone can produce both acute and chronic injury in sensitive plant species depending on the concentration level and the duration of the exposure.<sup>193</sup> In those sensitive species,<sup>194</sup> effects from repeated exposure to ozone throughout the growing season of the plant can tend to accumulate, so even relatively low concentrations experienced for a longer duration have the potential to create chronic stress on vegetation.<sup>195</sup> <sup>196</sup>

Ozone damage to sensitive plant species includes impaired photosynthesis and visible injury to leaves. The impairment of photosynthesis, the process by which the plant makes carbohydrates (its

source of energy and food), can lead to reduced crop yields, timber production, and plant productivity and growth. Impaired photosynthesis can also lead to a reduction in root growth and carbohydrate storage below ground, resulting in other, more subtle plant and ecosystem impacts.<sup>197</sup> These latter impacts include increased susceptibility of plants to insect attack, disease, harsh weather, interspecies competition, and overall decreased plant vigor. The adverse effects of ozone on areas with sensitive species could potentially lead to species shifts and loss from the affected ecosystems,<sup>198</sup> resulting in a loss or reduction in associated ecosystem goods and services. Additionally, visible ozone injury to leaves can result in a loss of aesthetic value in areas of special scenic significance like national parks and wilderness areas and reduced use of sensitive ornamentals in landscaping.<sup>199</sup> In addition to ozone effects on vegetation, newer evidence suggests that ozone affects interactions between plants and insects by altering chemical signals (*e.g.*, floral scents) that plants use to communicate to other community members, such as attraction of pollinators.

The Ozone ISA presents more detailed information on how ozone affects vegetation and ecosystems.<sup>200</sup> <sup>201</sup> The Ozone ISA reports causal and likely causal relationships between ozone exposure and a number of welfare effects and characterizes the weight of evidence for different effects associated with ozone.<sup>202</sup> The Ozone ISA concludes that visible foliar injury effects on vegetation, reduced vegetation growth, reduced plant reproduction, reduced productivity in terrestrial ecosystems, reduced yield and quality of agricultural crops, alteration of below-ground biogeochemical cycles, and altered terrestrial community

composition are causally associated with exposure to ozone. It also concludes that increased tree mortality, altered herbivore growth and reproduction, altered plant-insect signaling, reduced carbon sequestration in terrestrial ecosystems, and alteration of terrestrial ecosystem water cycling are likely to be causally associated with exposure to ozone.

## 3. Atmospheric Deposition

The Integrated Science Assessment for Oxides of Nitrogen, Oxides of Sulfur, and Particulate Matter—Ecological Criteria documents the ecological effects of the deposition of these criteria air pollutants.<sup>203</sup> It is clear from the body of evidence that NO<sub>x</sub>, oxides of sulfur (SO<sub>x</sub>), and PM contribute to total nitrogen (N) and sulfur (S) deposition. In turn, N and S deposition cause either nutrient enrichment or acidification depending on the sensitivity of the landscape or the species in question. Both enrichment and acidification are characterized by an alteration of the biogeochemistry and the physiology of organisms, resulting in harmful declines in biodiversity in terrestrial, freshwater, wetland, and estuarine ecosystems in the United States. Decreases in biodiversity mean that some species become relatively less abundant and may be locally extirpated. In addition to the loss of unique living species, the decline in total biodiversity can be harmful because biodiversity is an important determinant of the stability of ecosystems and their ability to provide socially valuable ecosystem services.

Terrestrial, wetland, freshwater, and estuarine ecosystems in the United States are affected by N enrichment/ eutrophication caused by N deposition. These effects have been consistently documented across the United States for hundreds of species. In aquatic systems increased N can alter species assemblages and cause eutrophication. In terrestrial systems N loading can lead to loss of nitrogen-sensitive lichen species, decreased biodiversity of grasslands, meadows and other sensitive habitats, and increased potential for invasive species. For a broader explanation of the topics treated here, refer to the description in Chapter 4 of the RIA.

The sensitivity of terrestrial and aquatic ecosystems to acidification from N and S deposition is predominantly governed by geology. Prolonged exposure to excess nitrogen and sulfur

<sup>197</sup> 73 FR 16492, March 27, 2008.

<sup>198</sup> 73 FR 16493–16494, March 27, 2008. Ozone impacts could be occurring in areas where plant species sensitive to ozone have not yet been studied or identified.

<sup>199</sup> 73 FR 16490–16497, March 27, 2008.

<sup>200</sup> U.S. EPA. Integrated Science Assessment (ISA) for Ozone and Related Photochemical Oxidants (Final Report). U.S. Environmental Protection Agency, Washington, DC, EPA/600/R–20/012, 2020.

<sup>201</sup> U.S. EPA. Integrated Science Assessment (ISA) for Ozone and Related Photochemical Oxidants (Final Report). U.S. Environmental Protection Agency, Washington, DC, EPA/600/R–20/012, 2020.

<sup>202</sup> The Ozone ISA evaluates the evidence associated with different ozone related health and welfare effects, assigning one of five “weight of evidence” determinations: causal relationship, likely to be a causal relationship, suggestive of a causal relationship, inadequate to infer a causal relationship, and not likely to be a causal relationship. For more information on these levels of evidence, please refer to Table II of the ISA.

<sup>203</sup> U.S. EPA. Integrated Science Assessment (ISA) for Oxides of Nitrogen, Oxides of Sulfur and Particulate Matter Ecological Criteria (Final Report). U.S. Environmental Protection Agency, Washington, DC, EPA/600/R–20/278, 2020.

<sup>193</sup> 73 FR 16486, March 27, 2008.

<sup>194</sup> 73 FR 16491, March 27, 2008. Only a small percentage of all the plant species growing within the U.S. (over 43,000 species have been catalogued in the USDA PLANTS database) have been studied with respect to ozone sensitivity.

<sup>195</sup> U.S. EPA. Integrated Science Assessment (ISA) for Ozone and Related Photochemical Oxidants (Final Report). U.S. Environmental Protection Agency, Washington, DC, EPA/600/R–20/012, 2020.

<sup>196</sup> The concentration at which ozone levels overwhelm a plant's ability to detoxify or compensate for oxidant exposure varies. Thus, whether a plant is classified as sensitive or tolerant depends in part on the exposure levels being considered.

deposition in sensitive areas acidifies lakes, rivers, and soils. Increased acidity in surface waters creates inhospitable conditions for biota and affects the abundance and biodiversity of fishes, zooplankton, and macroinvertebrates and ecosystem function. Over time, acidifying deposition also removes essential nutrients from forest soils, depleting the capacity of soils to neutralize future acid loadings and negatively affecting forest sustainability. Major effects in forests include a decline in sensitive tree species, such as red spruce (*Picea rubens*) and sugar maple (*Acer saccharum*).

Building materials including metals, stones, cements, and paints undergo natural weathering processes from exposure to environmental elements (e.g., wind, moisture, temperature fluctuations, sunlight, etc.). Pollution can worsen and accelerate these effects. Deposition of PM is associated with both physical damage (materials damage effects) and impaired aesthetic qualities (soiling effects). Wet and dry deposition of PM can physically affect materials, adding to the effects of natural weathering processes, by potentially promoting or accelerating the corrosion of metals, by degrading paints, and by deteriorating building materials such as stone, concrete, and marble.<sup>204</sup> The effects of PM are exacerbated by the presence of acidic gases and can be additive or synergistic due to the complex mixture of pollutants in the air and surface characteristics of the material. Acidic deposition has been shown to have an effect on materials including zinc/galvanized steel and other metal, carbonate stone (such as monuments and building facings), and surface coatings (paints).<sup>205</sup> The effects on historic buildings and outdoor works of art are of particular concern because of the uniqueness and irreplaceability of many of these objects. In addition to aesthetic and functional effects on metals, stone, and glass, altered energy efficiency of photovoltaic panels by PM deposition is also becoming an important consideration for impacts of air pollutants on materials.

#### 4. Environmental Effects of Air Toxics

Emissions from producing, transporting, and combusting fuel contribute to ambient levels of

pollutants that contribute to adverse effects on vegetation. VOCs, some of which are considered air toxics, have long been suspected to play a role in vegetation damage.<sup>206</sup> In laboratory experiments, a wide range of tolerance to VOCs has been observed.<sup>207</sup> Decreases in harvested seed pod weight have been reported for the more sensitive plants, and some studies have reported effects on seed germination, flowering, and fruit ripening. Effects of individual VOCs or their role in conjunction with other stressors (e.g., acidification, drought, temperature extremes) have not been well studied. In a recent study of a mixture of VOCs including ethanol and toluene on herbaceous plants, significant effects on seed production, leaf water content, and photosynthetic efficiency were reported for some plant species.<sup>208</sup>

Research suggests an adverse impact of vehicle exhaust on plants, which has in some cases been attributed to aromatic compounds and in other cases to NO<sub>x</sub>.<sup>209 210 211</sup> The impacts of VOCs on plant reproduction may have long-term implications for biodiversity and survival of native species near major roadways. Most of the studies of the impacts of VOCs on vegetation have focused on short-term exposure and few studies have focused on long-term effects of VOCs on vegetation and the potential for metabolites of these compounds to affect herbivores or insects.

### III. Test Procedures and Standards

In applying heavy-duty criteria pollutant emission standards, EPA divides engines primarily into two types: Compression ignition (CI) (primarily diesel-fueled engines) and spark-ignition (SI) (primarily gasoline-fueled engines). The CI standards and

requirements also apply to the largest natural gas engines. Battery-electric and fuel-cell vehicles are also subject to criteria pollutant standards and requirements. Criteria pollutant exhaust emission standards apply for four criteria pollutants: Oxides of nitrogen (NO<sub>x</sub>), particulate matter (PM), hydrocarbons (HC), and carbon monoxide (CO).<sup>212</sup> In this Section III we describe new emission standards that will apply for these pollutants starting in MY 2027. We also describe new and updated test procedures we are finalizing in this rule.

Section III.A provides an overview of provisions that broadly apply for this final rule. Section III.B and Section III.D include the new laboratory-based standards and final updates to test procedures for heavy-duty compression-ignition and spark-ignition engines, respectively. Section III.C introduces the final off-cycle standards and test procedures that apply for compression-ignition engines and extend beyond the laboratory to on-the-road, real-world conditions. Section III.E describes the new refueling standards we are finalizing for certain heavy-duty spark-ignition engines. Each of these sections describe the final new standards and their basis, as well as describe the new test procedures and any updates to current test procedures, and describe our rationale for the final program, including feasibility demonstrations, available data, and comments received.

#### A. Overview

##### 1. Migration and Clarifications of Regulatory Text

As noted in Section I of this preamble, we are migrating our criteria pollutant regulations for model year 2027 and later heavy-duty highway engines from their current location in 40 CFR Part 86, subpart A, to 40 CFR Part 1036.<sup>213</sup> Consistent with this migration, the compliance provisions discussed in this preamble refer to the regulations in their new location in part 1036. In general, this migration is not intended to change the compliance program specified in part 86, except as specifically finalized in this rulemaking. EPA submitted a memorandum to the docket describing how we proposed to migrate

<sup>212</sup> Reference to hydrocarbon (HC) standards includes nonmethane hydrocarbon (NMHC), nonmethane-nonethane hydrocarbon (NMNEHC) and nonmethane hydrocarbon equivalent (NMHCE). See 40 CFR 86.007–11.

<sup>213</sup> As noted in the following sections, we are proposing some updates to 40 CFR parts 1037, 1065, and 1068 to apply to other sectors in addition to heavy-duty highway engines.

<sup>204</sup> U.S. EPA. Integrated Science Assessment (ISA) for Particulate Matter (Final Report, 2019). U.S. Environmental Protection Agency, Washington, DC, EPA/600/R-19/188, 2019.

<sup>205</sup> Irving, P.M., e.d. 1991. Acid Deposition: State of Science and Technology, Volume III, Terrestrial, Materials, Health, and Visibility Effects, The U.S. National Acid Precipitation Assessment Program, Chapter 24, page 24–76.

<sup>206</sup> U.S. EPA. (1991). Effects of organic chemicals in the atmosphere on terrestrial plants. EPA/600/3-91/001.

<sup>207</sup> Cape J.N., I.D. Leith, J. Binnie, J. Content, M. Donkin, M. Skewes, D.N. Price, A.R. Brown, A.D. Sharpe. (2003). Effects of VOCs on herbaceous plants in an open-top chamber experiment. *Environ. Pollut.* 124:341–343.

<sup>208</sup> Cape J.N., I.D. Leith, J. Binnie, J. Content, M. Donkin, M. Skewes, D.N. Price, A.R. Brown, A.D. Sharpe. (2003). Effects of VOCs on herbaceous plants in an open-top chamber experiment. *Environ. Pollut.* 124:341–343.

<sup>209</sup> Viskari E-L. (2000). Epicuticular wax of Norway spruce needles as indicator of traffic pollutant deposition. *Water, Air, and Soil Pollut.* 121:327–337.

<sup>210</sup> Ugrehelidze D., F. Korte, G. Kvesitadze. (1997). Uptake and transformation of benzene and toluene by plant leaves. *Ecotox. Environ. Safety* 37:24–29.

<sup>211</sup> Kammerbauer H., H. Selinger, R. Rommelt, A. Ziegler-Jons, D. Knoppik, B. Hock. (1987). Toxic components of motor vehicle emissions for the spruce *Picea abies*. *Environ. Pollut.* 48:235–243.

certification and compliance provisions into 40 CFR part 1036.<sup>214</sup>

i. Compression- and Spark-Ignition Engines Regulatory Text

For many years, the regulations of 40 CFR part 86 have referred to “diesel heavy-duty engines” and “Otto-cycle heavy-duty engines”; however, as we migrate the heavy-duty provisions of 40 CFR part 86, subpart A, to 40 CFR part 1036 in this rule, we proposed to refer to these engines as “compression-ignition” (CI) and “spark-ignition” (SI), respectively, which are more comprehensive terms and consistent with existing language in 40 CFR part 1037 for heavy-duty motor vehicle regulations. We also proposed to update the terminology for the primary intended service classes in 40 CFR 1036.140 to replace Heavy heavy-duty engine with Heavy HDE, Medium heavy-duty engine with Medium HDE, Light heavy-duty engine with Light HDE, and Spark-ignition heavy-duty engine with Spark-ignition HDE.<sup>215</sup> We received no adverse comment and are finalizing these terminology changes, as proposed. This final rule revises 40 CFR parts 1036 and 1037 to reflect this updated terminology. Throughout this preamble, reference to diesel and Otto-cycle engines and the previous service class nomenclature is generally limited to discussions relating to current test procedures and specific terminology used in 40 CFR part 86. Heavy-duty engines not meeting the definition of compression-ignition or spark-ignition are deemed to be compression-ignition engines for purposes of part 1036, per 40 CFR 1036.1(c) and are subject to standards in 40 CFR 1036.104.

ii. Heavy-Duty Hybrid Regulatory Text

Similar to our updates to more comprehensive and consistent terminology for CI and SI engines, as part of this rule we are also finalizing three main updates and clarifications to regulatory language for hybrid engines and hybrid powertrains. First, as proposed, we are finalizing an updated definition of “engine configuration” in 40 CFR 1036.801; the updated definition clarifies that an engine configuration includes hybrid components if it is certified as a hybrid engine or hybrid powertrain. Second, we are finalizing, as proposed, a clarification in 40 CFR

1036.101(b) that regulatory references in part 1036 to engines generally apply to hybrid engines and hybrid powertrains. Third, we are finalizing as proposed that manufacturers may optionally test the hybrid engine and powertrain together, rather than testing the engine alone. The option to test hybrid engine and powertrain together allows manufacturers to demonstrate emission performance of the hybrid technology that are not apparent when testing the engine alone. If the emissions results of testing the hybrid engine and powertrain together show NO<sub>x</sub> emissions lower than the final standards, then EPA anticipates that manufacturers may choose to participate in the NO<sub>x</sub> ABT program in the final rule (see preamble Section IV.G for details on the final ABT program).

We requested comment on our proposed clarification in 40 CFR 1036.101(b) that manufacturers may optionally test the hybrid engine and powertrain together, rather than testing the engine alone, and specifically, whether EPA should require all hybrid engines and powertrains to be certified together, rather than making it optional. For additional details on our proposed updates and clarifications to regulatory language for hybrid engines and hybrid powertrains, as well as our specific requests for comment on these changes, see the proposed rule preamble (87 FR 17457, March 28, 2022).

Several commenters support the proposal to allow manufacturers to certify hybrid powertrains with a powertrain test procedure, but urge EPA to continue to allow manufacturers to certify hybrid systems using engine dynamometer testing procedures. These commenters stated that the powertrain dynamometer test procedures produce emission results that are more representative of hybrid engine or powertrain on-road operation than engine-only testing, however, commenters also stated the proposed test cycles are not reflective of real-world applications where hybrid technology works well and urged EPA to finalize different duty-cycles. In contrast, one commenter pointed to data collected from light-duty hybrid electric vehicles in Europe that the commenter stated shows hybrid-electric vehicles (HEVs) emit at higher levels than demonstrated in current certification test procedures; based on those data the commenter stated that EPA should not allow HEVs to generate NO<sub>x</sub> emissions credits. Separately, some commenters also stated that requiring powertrain testing for hybrid engines or hybrid powertrains certification would add

regulatory costs or other logistical challenges.

After considering these comments, EPA has determined that powertrain testing for hybrid systems should remain an option in this final rule. This option allows manufacturers to demonstrate emission performance of the hybrid technology, without requiring added test burden or logistical constraints. We are therefore finalizing as proposed the allowance for manufacturers to test the hybrid engine and powertrain together. If testing the hybrid engine and hybrid powertrain together results in NO<sub>x</sub> emissions that are below the final standards, then manufacturers can choose to certify to a FEL below the standard, and then generate NO<sub>x</sub> emissions credits as provided under the final ABT program (see Section IV.G). We disagree with one commenter who asserted that manufacturers should not be allowed to generate NO<sub>x</sub> emissions credits from HEVs based on data showing higher emissions from HEVs operating in the real-world compared to certification test data in Europe. Rather, we expect the powertrain test procedures we are finalizing will accurately reflect NO<sub>x</sub> emissions from HEVs due to the specifications we are including in the final test procedures, which differ from the certification test procedures to which the commenter referred.<sup>216</sup> See preamble Section III.B.2.v for more details on the powertrain test procedures that we are finalizing.

Similarly, we disagree with those commenters urging EPA to finalize different duty-cycle tests to reflect hybrid real-world operations. While the duty-cycles suggested by commenters would represent some hybrid operations, they would not represent the duty-cycles of other hybrid vehicle types. See Section 3 of the Response to Comments document for additional details on our responses to comments on different duty-cycles for hybrid vehicles, and responses to other comments on hybrid engines and hybrid powertrains.

In addition to our three main proposed updates and clarifications to regulatory language for hybrid engines and hybrid powertrain, we also proposed that manufacturers would certify a hybrid engine or hybrid powertrain to criteria pollutant

<sup>214</sup> Stout, Alan; Brakora, Jessica. Memorandum to docket EPA-HQ-OAR-2019-0055. “Technical Issues Related to Migrating Heavy-Duty Highway Engine Certification Requirements from 40 CFR part 86, subpart A, to 40 CFR part 1036”. March 2022.

<sup>215</sup> This new terminology for engines is also consistent with the “HDV” terminology used for vehicle classifications in 40 CFR 1037.140.

<sup>216</sup> We note that the data provided by the commenter was specific to light-duty vehicles and evaluated CO<sub>2</sub> emissions, not criteria pollutant emissions. EPA proposed and is finalizing changes to the light-duty test procedures for HEVs; in this Section III we focus on heavy-duty test procedures. See preamble Section XI and RTC Section 32 for details on the light-duty test procedures for HEVs.



standards by declaring a primary intended service class of the engine configuration using the proposed, updated 40 CFR 1036.140.<sup>217</sup> Our proposal included certifying to the same useful life requirements of the primary intended service class, which would provide truck owners and operators with similar assurance of durability regardless of the powertrain configuration they choose. Finally, we proposed an update to 40 CFR 1036.230(e) such that engine configurations certified as a hybrid engine or hybrid powertrain may not be included in an engine family with conventional engines, which is consistent with the current provisions. We received no adverse comment and are finalizing as proposed these updates to 40 CFR 1036.140 and 1036.230(e).

### iii. Heavy-Duty Zero Emissions Vehicles Regulatory Text

As part of this final rule we are also updating and consolidating regulatory language for battery-electric vehicles and fuel cell electric vehicles (BEVs and FCEVs), collectively referred to as zero emissions vehicles (ZEVs). For ZEVs, we are finalizing as proposed a consolidation and update to our regulations as part of a migration of heavy-duty vehicle regulations from 40 CFR part 86 to 40 CFR part 1037. In the HD GHG Phase 1 rulemaking, EPA revised the heavy-duty vehicle and engine regulations to make them consistent with our regulatory approach to electric vehicles (EVs) under the light-duty vehicle program. Specifically, we applied standards for all regulated criteria pollutants and GHGs to all heavy-duty vehicle types, including EVs.<sup>218</sup> Starting in MY 2016, criteria pollutant standards and requirements applicable to heavy-duty vehicles at or below 14,000 pounds gross vehicle weight rating (GVWR) in 40 CFR part 86, subpart S, applied to heavy-duty EVs above 14,000 pounds GVWR through the use of good engineering judgment (see current 40 CFR 86.016–1(d)(4)). Under the current 40 CFR 86.016–1(d)(4), heavy-duty vehicles powered solely by electricity are deemed to have zero emissions of regulated pollutants; this provision also provides that heavy-duty EVs may not generate NO<sub>x</sub> or PM emission credits.

As proposed, this final rule consolidates certification requirements for ZEVs over 14,000 pounds GVWR in

40 CFR part 1037 such that manufacturers of ZEVs over 14,000 pounds GVWR will certify to meeting the emission standards and requirements of 40 CFR part 1037. There are no criterial pollutant emission standards in 40 CFR part 1037, so we state in a new 40 CFR 1037.102, with revisions from the proposed rule, that heavy-duty vehicles without propulsion engines are subject to the same criteria pollutant emission standards that apply for engines under 40 CFR part 86, subpart A, and 40 CFR part 1036. We further specify in the final 40 CFR 1037.102 that ZEVs are deemed to have zero tailpipe emissions of criteria pollutants. As discussed in Section IV.G, we are choosing not to finalize our proposal to allow manufacturers to generate NO<sub>x</sub> emission credits from ZEVs if the vehicle met certain proposed requirements. We are accordingly carrying forward in the final 40 CFR 1037.102 a provisions stating that manufacturers may not generate emission credits from ZEVs. We are choosing not to finalize the proposed durability requirements for ZEVs, but we may choose in a future action to reexamine this issue. We are finalizing as proposed to continue to not allow heavy-duty ZEVs to generate PM emission credits since we are finalizing as proposed not to allow any manufacturer to generate PM emission credits for use in MY 2027 and later under the final ABT program presented in Section IV.G.

The provisions in existing and final 40 CFR 1037.5 defer to 40 CFR 86.1801–12 to clarify how certification requirements apply for heavy-duty vehicles at or below 14,000 pounds GVWR. Emission standards and certification requirements in 40 CFR part 86, subpart S, generally apply for complete heavy-duty vehicles at or below 14,000 pounds GVWR. We proposed to also apply emission standards and certification requirements under 40 CFR part 86, subpart S, for all incomplete vehicles at or below 14,000 pounds GVWR. We decided not to adopt this requirement and are instead continuing to allow manufacturers to choose whether to certify incomplete vehicles at or below 14,000 pounds GVWR to the emission standards and certification requirements in either 40 CFR part 86, subpart S, or 40 CFR part 1037.

## 2. Numeric Standards and Test Procedures for Compression-Ignition and Spark-Ignition Engines

As summarized in preamble Section I.B and detailed in this preamble Section III, we are finalizing numeric

NO<sub>x</sub> standards and useful life periods that are largely consistent with the most stringent proposed option for MY 2027. The specific standards are summarized in Section III.B, Section 0, Section III.D, and Section III.E. As required by CAA section 202(a)(3), EPA is finalizing new NO<sub>x</sub>, PM, HC, and CO emission standards for heavy-duty engines that reflect the greatest degree of emission reduction achievable through the application of technology that we have determined would be available for MY 2027, and in doing so have given appropriate consideration to additional factors, namely lead time, cost, energy, and safety. For all heavy-duty engine classes, the final numeric NO<sub>x</sub> standards for medium- and high-load engine operations match the most stringent standards proposed for MY 2027; for low-load operations we are finalizing the most stringent standard proposed for any model year (see III.B.2.iii for discussion).<sup>219</sup> For smaller heavy-duty engine service classes (*i.e.*, light and medium heavy-duty engines CI and SI heavy-duty engines), the numeric standards are combined with the longest useful life periods we proposed. For the largest heavy-duty engines (*i.e.*, heavy heavy-duty engines), the final numeric standards are combined with the longest useful life mileage that we proposed for MY 2027. The final useful life periods for the largest heavy-duty engines are 50 percent longer than today's useful life periods, which will play an important role in ensuring continued emissions control while the engines operate on the road. The final numeric emissions standards and useful life periods for all heavy-duty engines are based on further consideration of data included in the proposal from our engine demonstration programs that show the final emissions standards are feasible at the final useful life periods applicable to these each heavy-duty engine service class. Our assessment of the data available at the time of proposal is further supported by our evaluation of additional information and public comments stating that the proposed standards are feasible. Our technical assessments are primarily based on results from testing several diesel engine and aftertreatment systems at Southwest Research Institute and at EPA's National Vehicle and Fuel Emissions Laboratory (NVFEL), as well as heavy-duty gasoline engine testing conducted at NVFEL; we also

<sup>217</sup> The current provisions of 40 CFR 1036.140 distinguish classes based on engine characteristics and characteristics of the vehicles for which manufacturers intend to design and market their engines.

<sup>218</sup> 76 FR 57106, September 15, 2011.

<sup>219</sup> As proposed, we are finalizing a new test procedure for heavy-duty CI engines to demonstrate emission control when the engine is operating under low-load and idle conditions; this new test procedure does not apply to heavy-duty SI engines (see Section III.B.2.iii for additional discussion).

considered heavy-duty engine certification data submitted to EPA by manufacturers, ANPR and NPRM comments, and other data submitted by industry stakeholders or studies conducted by EPA, as more specifically identified in the sections that follow.

After further consideration of the data included in the proposal, as well as information submitted by commenters and additional data we collected since the time of proposal, we are finalizing two updates from our proposed testing requirements in order to ensure the greatest emissions reductions technically achievable are met throughout the final useful life periods; these updates are tailored to the larger engine classes (medium and heavy heavy-duty engines). First, we are finalizing a requirement for manufacturers to demonstrate before heavy heavy-duty engines are in-use that the emissions control technology is durable through a period of time longer than the final useful life mileage. For these largest engines with the longest useful life mileages, the extended laboratory durability demonstration will better ensure the final standards will be met throughout the regulatory useful life under real-world operations where conditions are more variable. Second, we are finalizing an interim in-use compliance allowance that applies when EPA evaluates whether heavy or medium heavy-duty engines are meeting the final standards after these engines are in use in the real-world. When combined with the final useful life values, we believe the interim in-use compliance allowance will address concerns raised in comments from manufacturers that the more stringent proposed MY 2027 standards would not be feasible to meet over the very long useful life periods of heavy heavy-duty engines, or under the challenging duty-cycles of medium heavy-duty engines. This interim, in-use compliance allowance is generally consistent with our past practice (for example, see 66 FR 5114, January 18, 2001); also consistent with past practice, the compliance allowance is included as an interim provision that we may reassess in the future through rulemaking based on the performance of emissions controls over the final useful life periods for medium and heavy heavy-duty engines.<sup>220</sup> To set standards that result in the greatest

<sup>220</sup> We plan to closely monitor the in-use emissions performance of model year 2027 and later engines to determine the long-term need for the interim compliance allowance. For example, we intend to analyze the data from the manufacturer run in-use testing program to compare how engines age in the field compared to how they age in the laboratory.

emission reductions achievable for medium and heavy heavy-duty engines, we considered additional data that we and others collected since the time of the proposal; these data show the significant technical challenge of maintaining very low NO<sub>x</sub> emissions throughout very long useful life periods for heavy heavy-duty engines, and greater amounts of certain aging mechanisms over the long useful life periods of medium heavy-duty engines. In addition to these data, in setting the standards we gave appropriate consideration to costs associated with the application of technology to achieve the greatest emissions reductions in MY 2027 (*i.e.*, cost of compliance for manufacturers associated with the standards<sup>221</sup>) and other statutory factors, including energy and safety. We determined that for heavy heavy-duty engines the combination of: (1) The most stringent MY 2027 standards proposed, (2) longer useful life periods compared to today's useful life periods, (3) targeted, interim compliance allowance approach to in-use compliance testing, and (4) the extended durability demonstration for emissions control technologies is appropriate, feasible, and consistent with our authority under the CAA to set technology-forcing criteria pollutant standards for heavy-duty engines for their useful life.<sup>222</sup> Similarly, for

<sup>221</sup> More specifically, for this rule in setting the final standards and consistent with CAA section 202(a)(3)(A), the cost of compliance for manufacturers associated with the standards that EPA gave appropriate consideration to includes the direct manufacturing costs and indirect costs incurred by manufacturers associated with meeting the final standards over the corresponding final useful life values, given that this rule sets new more stringent standards through both the numeric level of the standard and the length of the useful life period.

<sup>222</sup> CAA section 202(a)(3)(A) is a technology-forcing provision and reflects Congress' intent that standards be based on projections of future advances in pollution control capability, considering costs and other statutory factors. See *National Petrochemical & Refiners Association v. EPA*, 287 F.3d 1130, 1136 (D.C. Cir. 2002) (explaining that EPA is authorized to adopt "technology-forcing" regulations under CAA section 202(a)(3)); *NRDC v. Thomas*, 805 F.2d 410, 428 n.30 (D.C. Cir. 1986) (explaining that such statutory language that "seek[s] to promote technological advances while also accounting for cost does not detract from their categorization as technology-forcing standards"); see also *Husqvarna AB v. EPA*, 254 F.3d 195 (D.C. Cir. 2001) (explaining that CAA sections 202 and 213 have similar language and are technology-forcing standards). In this context, the term "technology-forcing" has a specific legal meaning and is used to distinguish standards that may require manufacturers to develop new technologies (or significantly improve existing technologies) from standards that can be met using existing off-the-shelf technology alone. Technology-forcing standards such as those in this final rule do not require manufacturers to use specific technologies.

medium heavy-duty engines we determined that the combination of the first three elements (*i.e.*, most stringent MY 2027 standards proposed, increase in useful life periods, and interim compliance allowance for in-use testing) is appropriate, feasible, and consistent with our CAA authority to set technology-forcing criteria pollutant standards for heavy-duty engines for their useful life.

In addition to the final standards for the defined duty cycle and off-cycle test procedures, the final standards include several other provisions for controlling emissions from specific operations in CI or SI engines. First, we are finalizing, as proposed, to allow CI engine manufacturers to voluntarily certify to idle standards using a new idle test procedure that is based on an existing California Air Resources Board (CARB) procedure.<sup>223</sup>

We are also finalizing two options for manufacturers to control engine crankcase emissions. Specifically, manufacturers will be required to either: (1) As proposed, close the crankcase, or (2) measure and account for crankcase emissions using an updated version of the current requirements for an open crankcase. We believe that either will ensure that the total emissions are accounted for during certification testing and throughout the engine operation during useful life. See Section III.B for more discussion on both the final idle and crankcase provisions.

For heavy-duty SI, we are finalizing as proposed a new refueling emission standard for incomplete vehicles above 14,000 lb GVWR starting in MY 2027.<sup>224</sup> The final refueling standard is based on the current refueling standard that applies to complete heavy-duty gasoline-fueled vehicles. Consistent with the current evaporative emission standards that apply for these same vehicles, we are finalizing a requirement that manufacturers can use an engineering analysis to demonstrate that they meet our final refueling standard. We are also adopting an optional alternative phase-in compliance pathway that manufacturers can opt into in lieu of being subject to this implementation date for all incomplete heavy-duty vehicles above 14,000 pounds GVWR (see Section III.E for details).

Consistent with our proposal, we are also finalizing several provisions to

<sup>223</sup> 13 CCR 1956.8 (a)(6)(C)—Optional NO<sub>x</sub> idling emission standard.

<sup>224</sup> Some vehicle manufactures sell their engines or "incomplete vehicles" (*i.e.*, chassis that include their engines, the frame, and a transmission) to body builders who design and assemble the final vehicle.

reduce emissions from a broader range of engine operating conditions. First, we are finalizing new standards for our existing test procedures to reduce emissions under medium- and high-load operations (e.g., when trucks are traveling on the highway). Second, we are finalizing new standards and a corresponding new test procedure to measure emissions during low-load operations (i.e., the low-load cycle, LLC). Third, we are finalizing new standards and updates to an existing test procedure to measure emissions over the broader range of operations that occur when heavy-duty engines are operating on the road (i.e., off-cycle).<sup>225</sup>

The new, more stringent numeric standards for the existing laboratory-based test procedures that measure emissions during medium- and high-load operations will ensure significant emissions reductions from heavy-duty engines. Without this final rule, these medium- and high-load operations are projected to contribute the most to heavy-duty NO<sub>x</sub> emissions in 2045.

We are finalizing as proposed a new LLC test procedure, which will ensure demonstration of emission control under sustained low-load operations. After further consideration of data included in the proposal, as well as additional information from the comments summarized in this section, we are finalizing the most stringent numeric standard for the LLC that we proposed for any model year. As discussed in our proposal, data from our CI engine demonstration program showed that the lowest numeric NO<sub>x</sub> standard proposed would be feasible for the LLC throughout a useful life period similar to the useful life we are finalizing for the largest heavy-duty engines. After further consideration of this data, and additional support from data collected since the time of proposal, we are finalizing the most stringent standard proposed for any model year.

We are finalizing new numeric standards and revisions to the proposed off-cycle test procedure. We proposed updates to the current off-cycle test procedure that included binning

emissions measurements based on the type of operation the engine is performing when the measurement data is being collected. Specifically, we proposed that emissions data would be grouped into three bins, based on if the engine was operating in idle (Bin 1), low-load (Bin 2), or medium-to-high load (Bin 3) operation. Given the different operational profiles of each of the three bins, we proposed a separate standard for each bin. Based on further consideration of data included in the proposal, as well as additional support from our consideration of data provided by commenters, we are finalizing off-cycle standards for two bins, rather than three bins; correspondingly, we are finalizing a two-bin approach for grouping emissions data collected during off-cycle test procedures. Our evaluation of available information shows that two bins better represent the differences in engine operations that influence emissions (e.g., exhaust temperature, catalyst efficiency) and ensure sufficient data is collected in each bin to allow for an accurate analysis of the data to determine if emissions comply with the standard for each bin. Preamble Section III.C further discusses the final off-cycle standards.

### 3. Implementation of the Final Program

As discussed in this section, we have evaluated the final standards in terms of technological feasibility, lead time, and stability, and given appropriate consideration to cost, energy, and safety, consistent with the requirements in CAA section 202(a)(3). The final standards are based on data from our CI and SI engine feasibility demonstration programs that was included in the proposal, and further supported by information submitted by commenters and additional data we collected since the time of proposal. Our evaluation of available data shows that the final standards and useful life periods are feasible and will result in the greatest emission reductions achievable for MY 2027, pursuant to CAA section 202(a)(3), giving appropriate consideration to cost, lead time, and other factors. We note that CAA section 202(a)(3) neither requires that EPA consider all the statutory factors equally nor mandates a specific method of cost analysis; rather EPA has discretion in determining the appropriate consideration to give such factors.<sup>226</sup> As

discussed in the Chapter 3 of the RIA, the final standards are achievable without increasing the overall fuel consumption and CO<sub>2</sub> emissions of the engine (1) for each of the duty cycles (SET, FTP, and LLC), and (2) for the fuel mapping test procedures defined in 40 CFR 1036.535 and 1036.540.<sup>227</sup> Finally, the final standards will have no negative impact on safety, based on the existing use of these technologies in light-duty and heavy-duty engines on the road today (see section 3 of the Response to Comments document for additional discussion on our assessment that the final standards will have no negative impact on safety). This includes the safety of closed crankcase systems, which we received comment on. As discussed in Section 3 of the RTC, one commenter stated that requiring closed crankcases could increase the chance of engine run away caused by combustion of engine oil that could enter the intake from the closed-crankcase system. We disagree with the commenter since closed crankcase systems are used on engines today with no adverse effect on safety; however, we are providing flexibility for manufactures to meet the final standards regarding crankcase emissions (see preamble Section III.B.2.vi for details).

While we have referenced a technology pathway for complying with our standards (Chapter 3 of the RIA) that is consistent with CAA section 202(a)(3), there are other technology pathways that manufacturers may choose in order to comply with the performance-based final standards. We did not rely on alternative technology pathways in our assessment of the feasibility of the final standards, however, manufacturers may choose from any number of technology pathways to comply with the final standards (e.g., alternative fuels, including biodiesel, renewable diesel, renewable natural gas, renewable propane, or hydrogen in combination with relevant emissions aftertreatment technologies, and electrification, including plug-in hybrid electric vehicles, battery-electric or fuel cell

<sup>225</sup> Duty-cycle test procedures measure emissions while the engine is operating over precisely defined duty cycles in an emissions testing laboratory and provide very repeatable emission measurements. "Off-cycle" test procedures measure emissions while the engine is not operating on a specified duty cycle; this testing can be conducted while the engine is being driven on the road (e.g., on a package delivery route), or in an emission testing laboratory. Both duty-cycle and off-cycle testing are conducted pre-production (e.g., for certification) or post-production to verify that the engine meets applicable duty-cycle or off-cycle emission standards throughout useful life (see Section III for more discussion).

<sup>226</sup> See, e.g., *Sierra Club v. EPA*, 325 F.3d 374, 378 (D.C. Cir. 2003) (explaining that similar technology forcing language in CAA section 202(l)(2) "does not resolve how the Administrator should weigh all [the statutory] factors in the process of finding the 'greatest emission reduction achievable'"); *Husqvarna AB v. EPA*, 254 F.3d 195, 200 (D.C. Cir.

2001) (explaining that under CAA section 213's similar technology-forcing authority that "EPA did not deviate from its statutory mandate or frustrate congressional will by placing primary significance on the 'greatest degree of emission reduction achievable'" or by considering cost and other statutory factors as important but secondary).

<sup>227</sup> The final ORVR requirements discussed in Section III.E will reduce fuel consumed from gasoline fuel engines, but these fuel savings will not be measured on the duty cycles since the test procedures for these tests measure tailpipe emissions and do not measure emissions from refueling. We describe our estimate of the fuel savings in Chapter 7 of the RIA.

electric vehicles). As noted in Section I, we are finalizing a program that will begin in MY 2027, which is the earliest year that standards can begin to apply under CAA section 202(a)(3)(C).<sup>228</sup> The final NO<sub>x</sub> standards are a single-step program that reflect the greatest emission reductions achievable starting in MY 2027, giving appropriate consideration to costs and other factors. In this final rule, we are focused on achieving the greatest emission reductions achievable in the MY 2027 timeframe, and have applied our judgment in determining the appropriate standards for MY 2027 under this authority for a national program. As the heavy-duty industry continues to transition to zero-emission technologies, EPA could consider additional criteria pollutant standards for model years beyond 2027 in future rules.

In the event that manufacturers start production of some engine families sooner than four years from our final rule, we are finalizing a provision for manufacturers to split the 2027 model year, with an option for manufacturers to comply with the final MY 2027 standards for all engines produced for that engine family in MY 2027. Specifically, we are finalizing as proposed that a MY 2027 engine family that starts production within four years of the final rule could comply with the final MY 2027 standards for all engines produced for that engine family in MY2027, or could split the engine family by production date in MY 2027 such that engines in the family produced prior to four years after the date that the final rule is promulgated would continue to be subject to the existing standards.<sup>229 230</sup> The split model year provision for MY 2027 provides assurance that all manufacturers, regardless of when they start production of their engine families, will have four years of lead time to the MY 2027 standards under this final rule, while also maximizing emission reductions, which is consistent with our CAA authority. This final rule is promulgated

upon the date of signature, upon which date EPA also provided this signed final rule to manufacturers and other stakeholders by email and posted it on EPA’s public website.<sup>231</sup>

4. Severability

This final rule includes new and revised requirements for numerous provisions under various aspects of the highway heavy-duty emission control program, including numeric standards, test procedures, regulatory useful life, emission-related warranty, and other requirements. Further, as explained in Sections I and XI, it modernizes and amends numerous other CFR parts for other standard-setting parts for various specific reasons. Therefore, this final rule is a multifaceted rule that addresses many separate things for independent reasons, as detailed in each respective section of this preamble. We intended each portion of this rule to be severable from each other, though we took the approach of including all the parts in one rulemaking rather than promulgating multiple rules to modernize each part of the program.

For example, the following portions of this rulemaking are mutually severable from each other, as numbered: (1) The emission standards in section III; (2) warranty in Section IV.B.1; (3) OBD requirements in Section IV.C; (4) inducements requirements in Section IV.D; (5) ABT program in Section IV.G; (6) the migration and clarification of regulatory text in Section III.A; and (7) other regulatory amendments discussed in Section XI. Each emission standard in Section III is also severable from each other emission standard, including for each duty-cycle, off-cycle, and refueling standard; each pollutant; and each primary intended service class. For example, the NO<sub>x</sub> standard for the FTP duty-cycle for Heavy HDE is severable from all other emission standards. Each of the migration and clarification regulatory amendments in Section III.A is also severable from all the other regulatory amendments in that Section, and each of the regulatory amendments in Section XI is also severable from all

the other regulatory amendments in that Section. If any of the above portions is set aside by a reviewing court, then we intend the remainder of this action to remain effective, and the remaining portions will be able to function absent any of the identified portions that have been set aside. Moreover, this list is not intended to be exhaustive, and should not be viewed as an intention by EPA to consider other parts of the rule not explicitly listed here as not severable from other parts of the rule.

B. Summary of Compression-Ignition Exhaust Emission Standards and Duty Cycle Test Procedures

EPA is finalizing new NO<sub>x</sub>, PM, HC, and CO emission standards for heavy-duty compression-ignition engines that will be certified under 40 CFR part 1036.<sup>232 233</sup> We are finalizing new emission standards for our existing laboratory test cycles (*i.e.*, SET and FTP) and finalizing new NO<sub>x</sub>, PM, HC and CO emission standards based on a new LLC, as described in this section.<sup>234</sup> The standards for NO<sub>x</sub>, PM, and HC are in units of milligrams/horsepower-hour instead of the grams/horsepower-hour used for existing standards because using units of milligrams better reflects the precision of the new standards, rather than adding multiple zeros after the decimal place. Making this change will require updates to how manufacturers report data to the EPA in the certification application, but it does not require changes to the test procedures that define how to determine emission values.

The final duty cycle emission standards in 40 CFR 1037.104 apply starting in model year 2027. This final rule includes new standards over the SET and FTP duty cycles currently used for certification, as well as new standards over a new LLC duty cycle to ensure manufacturers of compression-ignition engines are designing their engines to address emissions in during lower load operation that is not covered by the SET and FTP. The new standards are shown in Table III–1.

TABLE III–1—FINAL DUTY CYCLE EMISSION STANDARDS FOR LIGHT HDE, MEDIUM HDE, AND HEAVY HDE

Duty cycle	Model year 2027 and later			
	NO <sub>x</sub> <sup>a</sup> mg/hp-hr	HC mg/hp-hr	PM mg/hp-hr	CO g/hp-hr
SET and FTP .....	35	60	5	6.0

<sup>228</sup> Section 202(a)(3)(C) requires that standards under 202(a)(3)(A) apply no earlier than 4 years after promulgation, and apply for no less than 3 model years.

<sup>229</sup> See 40 CFR 86.007–11.

<sup>230</sup> 40 CFR 1036.150(t).

<sup>231</sup> This final rule will also be published in the **Federal Register**, and the effective date runs from the date of publication as specified in the **DATES** section. Note, non-substantive edits from the Office of the Federal Register may appear in the published version of the final rule.

<sup>232</sup> See 40 CFR 1036.104.

<sup>233</sup> See 40 CFR 1036.605 and Section XI.B of this preamble for a discussion of engines installed in specialty vehicles.

<sup>234</sup> See 40 CFR 1036.104.

TABLE III-1—FINAL DUTY CYCLE EMISSION STANDARDS FOR LIGHT HDE, MEDIUM HDE, AND HEAVY HDE—Continued

Duty cycle	Model year 2027 and later			
	NO <sub>x</sub> <sup>a</sup> mg/hp-hr	HC mg/hp-hr	PM mg/hp-hr	CO g/hp-hr
LLC .....	50	140	5	6.0

<sup>a</sup>An interim NO<sub>x</sub> compliance allowance of 15 mg/hp-hr applies for any in-use testing of Medium HDE and Heavy HDE. Manufacturers will add the compliance allowance to the NO<sub>x</sub> standard that applies for each duty cycle and for off-cycle Bin 2, for both in-use field testing and laboratory testing as described in 40 CFR part 1036, subpart E. Note, the NO<sub>x</sub> compliance allowance doesn't apply to confirmatory testing described in 40 CFR 1036.235(c) or selective enforcement audits described in 40 CFR part 1068.

This Section III.B describes the duty cycle emission standards and test procedures we are finalizing for compression-ignition engines. We describe compression-ignition engine technology packages that demonstrate the feasibility of achieving these standards in Section III.B.3.ii. The proposed rule provided an extensive discussion of the rationale and information supporting the proposed duty cycle standards (87 FR 17460, March 28, 2022). Chapters 1, 2, and 3 of the RIA include additional information related to the range of technologies to control criteria emissions, background on applicable test procedures, and the full feasibility analysis for compression-ignition engines. See also section 3 of the Response to Comments for a detailed discussion of the comments and how they have informed this final rule.

As part of this rulemaking, we are finalizing an increase in the useful life for each engine class as described in Section IV.A. The emission standards outlined in this section will apply for

the longer useful life periods and manufacturers will be responsible for demonstrating that their engines will meet these standards as part of the revisions to durability requirements described in Section IV.F. In Section IV.G, we discuss the updates to the ABT program, including updates to account for the three laboratory cycles (SET, FTP, and LLC) with unique standards.

1. Background on Existing Duty Cycle Test Procedures and Standards

We begin by providing background information on the existing duty cycle test procedures and standards as relevant to this final rule, including the SET and FTP standards and test procedures, powertrain and hybrid powertrain test procedures, test procedure adjustments to account for production and measurement variability, and crankcase emissions. Current criteria pollutant standards must be met by compression-ignition engines over both the SET and FTP duty cycles. The FTP duty cycles, which date back to the 1970s, are composites of a cold-start and a hot-start transient duty

cycle designed to represent urban driving. There are separate FTP duty cycles for both SI and CI engines. The cold-start emissions are weighted by one-seventh and the hot-start emissions are weighted by six-sevenths.<sup>235</sup> The SET is a more recent duty cycle for diesel engines that is a continuous cycle with ramped transitions between the thirteen steady-state modes.<sup>236</sup> The SET does not include engine starting and is intended to represent fully warmed-up operating modes not emphasized in the FTP, such as more sustained high speeds and loads.

Emission standards for criteria pollutants are currently set to the same numeric value for SET and FTP test cycles, as shown in Table III-2. Manufacturers of compression-ignition engines have the option under the existing regulations to participate in our ABT program for NO<sub>x</sub> and PM, as discussed in the background of Section IV.G.<sup>237</sup> These pollutants are subject to FEL caps under the existing regulations of 0.50 g/hp-hr for NO<sub>x</sub> and 0.02 g/hp-hr for PM.<sup>238</sup>

TABLE III-2—EXISTING PART 86 DIESEL-CYCLE ENGINE STANDARDS OVER THE SET AND FTP DUTY CYCLES

	NO <sub>x</sub> <sup>a</sup> (g/hp-hr)	PM <sup>b</sup> (g/hp-hr)	HC (g/hp-hr)	CO (g/hp-hr)
0.20 .....		0.01	0.14	15.5

<sup>a</sup>Engine families participating in the existing ABT program are subject to a FEL cap of 0.50 g/hp-hr for NO<sub>x</sub>.

<sup>b</sup>Engine families participating in the existing ABT program are subject to a FEL cap of 0.02 g/hp-hr for PM.

EPA developed powertrain and hybrid powertrain test procedures for the HD GHG Phase 2 Heavy-Duty Greenhouse Gas rulemaking (81 FR 73478, October 25, 2016) with updates in the HD Technical Amendments final rule (86 FR 34321, June 29, 2021).<sup>239</sup> The powertrain and hybrid powertrain tests allow manufacturers to directly measure the effectiveness of the engine, the transmission, the axle and the integration of these components as an

input to the Greenhouse gas Emission Model (GEM) for compliance with the greenhouse gas standards. As part of the technical amendments, EPA updated the powertrain test procedure to allow use of test cycles beyond the current GEM vehicle drive cycles, to include the SET and FTP engine-based test cycles and to facilitate hybrid powertrain testing (40 CFR 1036.510, 1036.512, and 1037.550).

These heavy-duty diesel-cycle engine standards are applicable for a useful life

period based on the primary intended service class of the engine.<sup>240</sup> For certification, manufacturers must demonstrate that their engines will meet these standards throughout the useful life by performing a durability test and applying a deterioration factor (DF) to their certification value.<sup>241</sup> Additionally, manufacturers must adjust emission rates for engines with exhaust aftertreatment to account for infrequent

<sup>235</sup> See 40 CFR 86.007-11 and 40 CFR 86.008-10.

<sup>236</sup> See 40 CFR 86.1362.

<sup>237</sup> See 40 CFR 86.007-15.

<sup>238</sup> See 40 CFR 86.007-11.

<sup>239</sup> See 40 CFR 1037.550.

<sup>240</sup> 40 CFR 86.004-2.

<sup>241</sup> See 40 CFR 86.004-26(c) and (d) and 86.004-28(c) and (d).

regeneration events accordingly.<sup>242</sup> To account for variability in these measurements, as well as production variability, manufacturers typically add margin between the DF plus infrequent regeneration adjustment factor (IRAF) adjusted test result and the FEL. A summary of the margins manufacturers have added for MY 2019 and newer engines is summarized in Chapter 3.1.2 of the RIA.

Current regulations restrict the discharge of crankcase emissions directly into the ambient air. Blowby gases from gasoline engine crankcases have been controlled for many years by sealing the crankcase and routing the gases into the intake air through a positive crankcase ventilation (PCV) valve. However, in the past there have been concerns about applying a similar technology for diesel engines. For example, high PM emissions venting into the intake system could foul turbocharger compressors. As a result of this concern, diesel-fueled and other compression-ignition engines equipped with turbochargers (or other equipment) were not required to have sealed crankcases (see 40 CFR 86.007–11(c)). For these engines, manufacturers are allowed to vent the crankcase emissions to ambient air as long as they are measured and added to the exhaust emissions during all emission testing to ensure compliance with the emission standards. Because all new highway heavy-duty diesel engines on the market today are equipped with turbochargers, they are not required to have closed crankcases under the current regulations. Chapter 1.1.4 of the RIA describes EPA's recent test program to evaluate the emissions from open crankcase systems on two modern heavy-duty diesel engines. Results suggest HC and CO emitted from the crankcase can be a notable fraction of overall tailpipe emissions. By closing the crankcase, those emissions would be rerouted to the engine or aftertreatment system to ensure emission control.

## 2. Test Procedures and Standards

As described in Section III.B.3.ii, we have determined that the technology packages evaluated for this final action can achieve the new duty-cycle standards. We are finalizing a single set of standards that take effect starting in MY 2027, including not only new numerical standards for new and existing duty-cycles but also other new numerical standards for revised off-cycles test procedures and compliance provisions, longer useful life periods, and other requirements.

The final standards were derived to achieve the maximum feasible emissions reductions from heavy-duty diesel engines for MY 2027, considering lead time, stability, cost, energy, and safety. To accomplish this, we evaluated what operation made up the greatest part of the inventory, as discussed in Section VI.B, and what technologies can be used to reduce emissions in these areas. As discussed in Section I, we project that emissions from operation at low power, medium-to-high power, and mileages beyond the current regulatory useful life of the engine will account for the majority of heavy-duty highway emissions in 2045. To achieve reductions in these three areas, we identified options for cycle-specific standards to ensure that the maximum achievable reductions are seen across the operating range of the engine. As described in Section IV, we are finalizing an increase in the regulatory useful life periods for each heavy-duty engine class to ensure these new standards are met for a greater portion of the engine's operational life. Also as described in Section IV, we are separately lengthening the warranty periods for each heavy-duty engine class, which is expected to help to maintain the benefits of the emission controls for a greater portion of the engine's operational life.

To achieve the goal of reducing emissions across the operating range of the engine, we are finalizing standards for three duty cycles (SET, FTP, and LLC). In finalizing these standards, we assessed the performance of the best available aftertreatment systems under various operating conditions. For example, we observed that these systems are more effective at reducing NO<sub>x</sub> emissions at the higher exhaust temperatures that occur at high engine power than they are at reducing NO<sub>x</sub> emissions at low exhaust temperatures that occur at low engine power. To achieve the maximum NO<sub>x</sub> reductions from the engine at maximum power, the aftertreatment system was designed to ensure that the downstream selective catalytic reduction (SCR) catalyst was properly sized, diesel exhaust fluid (DEF) was fully mixed with the exhaust gas ahead of the SCR catalyst and the diesel oxidation catalyst (DOC) was designed to provide a molar ratio of NO to NO<sub>2</sub> of near one. The final standards for the FTP and LLC are 80 to 90 percent, or more, lower as compared to current standards, which will contribute to reductions in emissions under low power operation and under cold-start conditions. The standards are achievable by utilizing cylinder

deactivation (CDA), dual-SCR aftertreatment configuration, closed crankcase, and heated diesel exhaust fluid (DEF) dosing. To reduce emissions under medium to high power, the final standards for the SET are greater than 80 percent lower as compared to current standards. The SET standards are achievable by utilizing improvements to the SCR formulation, SCR catalyst sizing, and improved mixing of DEF with the exhaust. Further information about these technologies can be found in Chapters 1 and 3 of the RIA.

The final PM standards are set at a level that requires heavy-duty engines to maintain the emissions performance of current diesel engines. The final standards for HC and CO are set at levels that are equivalent to the maximum emissions reductions achievable by spark-ignition engines over the FTP, with the general intent of making the final standards fuel neutral.<sup>243 244</sup> Compared to current standards, the final standards for the SET and FTP duty cycles are 50 percent lower for PM, 57 percent lower for HC, and 61 percent lower for CO. Each of these standards are discussed in more detail in the following sections.

For Heavy HDE, we are finalizing NO<sub>x</sub> standards to a useful life of 650,000 miles with a durability demonstration out to 750,000 miles, as discussed later in Section III.B.2. We recognize the greater demonstration burden of a useful life of 650,000 miles for these engines, and after careful analysis are updating our DF demonstration provisions to include two options for an accelerated aging demonstration. However, we also are taking into account that extending a durability demonstration, given that it is conducted in the controlled laboratory environment, will better ensure the final standards will be met throughout the longer final regulatory useful life mileage of 650,000 miles when these engines are operating in the real-world where conditions are more variable. We are thus requiring the durability demonstration to show that the emission control system hardware is designed to comply with the NO<sub>x</sub> standards out to 750,000 miles. As discussed further in Section III.B, the aging demonstration out to 750,000 miles in a controlled laboratory environment ensures that manufacturers are designing Heavy HDE to meet the

<sup>243</sup> See Section III.D for a discussion of these standards as they relate to Spark-ignition HDE.

<sup>244</sup> See 65 FR 6728 (February 10, 2000) and 79 FR 23454 (April 28, 2014) for more discussion on the principle of fuel neutrality applied in recent rulemakings for light-duty vehicle criteria pollutant standards.

<sup>242</sup> See 40 CFR 1036.501(d).

final standards out to the regulatory useful life of 650,000 miles once the engine is in the real-world, while reducing the risk of greater real world uncertainties impacting emissions at the longest useful life mileages in the proposed rule. This approach both sets standards that result in the maximum emission reductions achievable in MY 2027 while addressing the technical issues raised by manufacturers regarding various uncertainties in variability and the degradation of system performance over time due to contamination of the aftertreatment from, for example, fuel contamination (the latter of which is out of the manufacturer's control).

As discussed in Section III.B.3, we have assessed the feasibility of the standards for compression-ignition engines by testing a Heavy HDE equipped with cylinder CDA technology, closed crankcase, and dual-SCR aftertreatment configuration with heated DEF dosing. The demonstration work consisted of two phases. The first phase of the demonstration was led by CARB and is referred to as CARB Stage 3. In this demonstration the aftertreatment was chemically- and hydrothermally-aged to the equivalent of 435,000 miles. During this aging the emissions performance of the engine was assessed after the aftertreatment was degreened<sup>245</sup>, at the equivalent of 145,000 miles, 290,000 miles and

435,000 miles. The second phase of the demonstration was led by EPA and is referred to as the EPA Stage 3 engine. In this phase, improvements were made to the aftertreatment by replacing the zone-coated catalyzed soot filter with a separate DOC and diesel particulate filter (DPF) that were chemically- and hydrothermally-aged to the equivalent of 800,000 miles and improving the mixing of the DEF with exhaust prior to the downstream SCR catalyst. The EPA Stage 3 engine was tested at an age equivalent to 435,000, 600,000, and 800,000 miles. We also tested two additional aftertreatment systems, referred to as "System A" and "System B," which are each also a dual-SCR aftertreatment configuration with heated DEF dosing. However, they each have unique catalyst washcoat formulation and the "System A" aftertreatment has greater SCR catalyst volume. The details of these aftertreatment systems, along with the test results, can be found in RIA Chapter 3.

i. FTP

We are finalizing new emission standards for testing over the FTP duty cycle, as shown in Table III-3.<sup>246</sup> These brake-specific FTP standards apply across the Heavy HDE, Medium HDE, and Light HDE primary intended service classes over the useful life periods shown in Table III-4.<sup>247</sup> The numeric levels of the NO<sub>x</sub> FTP standards at the

time of certification are consistent with the most stringent proposed for MY 2027; as summarized in Section III.A.2 and detailed in this Section III.B we are also finalizing an interim, in-use compliance allowance for Medium and Heavy HDEs. The numeric level of the PM and CO FTP standards are the same as proposed, and the numeric level of the HC FTP standard is consistent with the proposed Option 1 standard starting in MY 2027. These standards have been shown to be feasible for compression-ignition engines based on testing of the CARB Stage 3 and EPA Stage 3 engine with a chemically- and hydrothermally-aged aftertreatment system.<sup>248</sup> The EPA Stage 3 engine, was aged to and tested at the equivalent of 800,000 miles.<sup>249</sup> EPA's System A demonstration engine, was aged to and tested at the equivalent of 650,000 miles.<sup>250</sup> The System B demonstration engine was not aged and was only tested after it was degreened. A summary of the data used for EPA's feasibility analysis can be found in Section III.B.3. See Section III.B.3 for details on how we addressed compliance margin when setting the standards, including discussion of the interim in-use testing allowance for Medium and Heavy HDE for determining the interim in-use testing standards for these primary intended service classes.

TABLE III-3—FINAL COMPRESSION-IGNITION ENGINE STANDARDS OVER THE SET AND FTP DUTY CYCLES

Model year	NO <sub>x</sub> (mg/hp-hr)	HC (mg/hp-hr)	PM (mg/hp-hr)	CO (g/hp-hr)
2027 and later	<sup>a</sup> 35	60	5	6.0

<sup>a</sup> An interim NO<sub>x</sub> compliance allowance of 15 mg/hp-hr applies for any in-use testing of Medium HDE and Heavy HDE. Manufacturers will add the compliance allowance to the NO<sub>x</sub> standard that applies for each duty cycle and for off-cycle Bin 2, for both in-use field testing and laboratory testing as described in 40 CFR part 1036, subpart E. Note, the NO<sub>x</sub> compliance allowance doesn't apply to confirmatory testing described in 40 CFR 1036.235(c) or selective enforcement audits described in 40 CFR part 1068.

TABLE III-4—USEFUL LIFE PERIODS FOR HEAVY-DUTY COMPRESSION-IGNITION PRIMARY INTENDED SERVICE CLASSES

Primary intended service class	Current (Pre-MY 2027)			Final MY 2027 and later		
	Miles	Years	Hours	Miles	Years	Hours
Light HDE <sup>a</sup>	110,000	10	.....	270,000	15	13,000
Medium HDE	185,000	10	.....	350,000	12	17,000
Heavy HDE	435,000	10	22,000	650,000	11	32,000

<sup>a</sup> Current useful life period for Light HDE for GHG emission standards is 15 years or 150,000 miles; we are not revising GHG useful life periods in this final rule. See 40 CFR 1036.108(d).

<sup>245</sup> Degreening is a process by which the catalyst is broken in and is critical in order to obtain a stable catalyst prior to assessing the catalyst's performance characteristics.

<sup>246</sup> See 40 CFR 1036.510 for the FTP duty-cycle test procedure.

<sup>247</sup> The same FTP duty-cycle standards apply for Spark-ignition HDE as discussed in Section III.D.

<sup>248</sup> See Section III.B.2 for a description of the engine.

<sup>249</sup> For the EPA Stage 3 engine, the data at the equivalent of 435,000 and 600,000 miles were included in the preamble of the NPRM and the data

at the equivalent of 800,000 miles was added to the docket on May 5th, 2022.

<sup>250</sup> Due to the timing of when the data from the System A system were available, the data were added to the public docket prior to the signing of the final rule.

As further discussed in Section III.B.3, taking into account measurement variability of the PM measurement test procedure and the low numeric level of the new PM standards, we believe PM emissions from current diesel engines are at the lowest feasible level for standards starting in MY 2027. As summarized in Section III.B.3.ii.b, manufacturers are submitting certification data to the agency for current production engines well below the existing PM standards over the FTP duty cycle. Setting the new PM FTP standards lower than the existing FTP PM standards, at 5 mg/hp-hr (0.005 g/hp-hr), ensures that future engines will maintain the low level of PM emissions of the current engines and not increase PM emissions. We received comment stating that a 5 mg/hp-hr standard did not provide enough margin for some engine designs and that a 7.5 mg/hp-hr would be a more appropriate standard to maintain current PM emissions levels while providing enough margin to account for the measurement variability of the PM measurement test procedure. The reason submitted in comment to justify the 7.5 mg/hp-hr standard was that data from the Stage 3 testing at Southwest Research Institute (SwRI) shows that in some conditions PM values exceed the 5 mg/hp-hr emission standard. EPA took a further look at this data and determined that the higher PM emission data points occur immediately following DPF ash cleaning, and that the PM level returns to a level well below the 5 mg/hp-hr standards shortly after return to service once a soot cake layer reestablishes itself in the DPF. EPA concluded from this assessment that these very short-term elevations in PM that occur after required maintenance of the DPF should not be the basis for the stringency of the PM standards and that the standards are feasible.

As noted earlier in this section, we are finalizing HC and CO FTP standards based on the feasibility demonstration for SI engines. As summarized in Section III.B.3.ii.b, manufacturers are submitting data to the agency that show emissions performance for current production CI engines that are well below the current standards. Keeping FTP standards at the same value for all fuels is consistent with the agency's approach to previous criteria pollutant standards. See Section III.D for more information on how the numeric values of the HC and CO standards were determined.

In the NPRM, we did not propose any changes to the weighting factors for the FTP cycle for heavy-duty engines. The current FTP weighting of cold-start and hot-start emissions was promulgated in

1980 (45 FR 4136, January 21, 1980). It reflects the overall ratio of cold and hot operation for heavy-duty engines generally and does not distinguish by engine size or intended use. We received comment to change the weighting factors to reduce the effect of the cold start portion of the FTP on the composite FTP emission results or to add 300 seconds of idle before the first acceleration in the cold start FTP to reduce the emissions impact of the cold start on the first acceleration. Duty-cycles are an approximation of the expected real-world operation of the engine and no duty cycle captures all aspects of the real-world operation. Changing the cold/hot weighting factors would not fully capture all aspects of what really occurs in-use, and there is precedent in experience and historical approach with the current  $\frac{1}{7}$  cold and  $\frac{6}{7}$  hot weighting factors. Adding 300 seconds of idle to the beginning of the FTP would simply reduce the stringency of the standard by reducing the impact of cold start emissions, as the 300 seconds of idle would allow the aftertreatment to light off prior to the first major acceleration in the FTP. Although the case can be made that many vehicles idle for some amount of time after start up, any attempt to add idle time before the first acceleration is simply an approximation and this "one size fits all" approach doesn't afford an improvement over the current FTP duty-cycle, nor does it allow determination of cold start emissions where the vehicle is underway shortly after start up. After considering these comments we are also not including any changes to the weighting factors for the FTP duty-cycle in this final rule.

For Heavy HDE, we are finalizing test procedures for the determination of deterioration factors in 40 CFR 1036.245 that require these engines to be aged to an equivalent of 750,000 miles, which is 15 percent longer than the regulatory useful life of those engines. As explained earlier in this section, we are finalizing this requirement for Heavy HDE to ensure the final NO<sub>x</sub> standard will be met through the lengthy regulatory useful life of 650,000 miles. See preamble Section IV.A for details on how we set the regulatory useful life for Heavy HDE.

#### ii. SET

We are finalizing new emissions standards for testing over the SET duty-cycle as shown in Table III-3. These brake-specific SET standards apply across the Heavy HDE, Medium HDE, and Light HDE primary intended service classes, as well as the SI HDE primary intended service class as discussed in

Section III.D, over the same useful life periods shown in Table III-4. The numeric levels of the NO<sub>x</sub> SET standards at the time of certification are consistent with the most stringent standard proposed for MY 2027.<sup>251</sup> The numeric level of the CO SET standard is consistent with the most stringent standard proposed for MY 2027 for all CI engine classes.<sup>252</sup> The numeric level of the PM SET standard is the same as proposed, and the numeric level of the HC SET standard is consistent with the proposed Option 1 standard starting in MY 2027. Consistent with our current standards, we are finalizing the same numeric values for the standards over the SET and FTP duty cycles for the CI engine classes. As with the FTP cycle, the standards have been shown to be feasible for compression-ignition engines based on testing of the CARB Stage 3 and EPA Stage 3 engines with a chemically- and hydrothermally-aged aftertreatment system. The EPA Stage 3 engine was aged to and tested at the equivalent of 800,000 miles.<sup>253</sup> EPA's Team A demonstration engine was aged to and tested at the equivalent of 650,000 miles.<sup>254</sup> See Section III.B.3 for details on how we addressed compliance margin when setting the standards, including discussion of the interim in-use testing allowance for Medium and Heavy HDEs for determining the interim in-use testing standards for these primary intended service classes. A summary of the data used for EPA's feasibility analysis can be found in Section III.B.3.

As with the PM standards for the FTP (see Section III.B.2.i), and as further discussed in Section III.B.3, taking into account measurement variability of the PM measurement test procedure and the low numeric level of the new PM standards, we believe PM emissions from current diesel engines are at the lowest feasible level for standards starting in MY 2027. Thus, the PM standard for the SET duty-cycle is intended to ensure that there is not an increase in PM emissions from future engines. We are finalizing new PM SET

<sup>251</sup> As discussed in Section III.B.3, we are finalizing an interim, in-use compliance allowance that applies when Medium and Heavy HDE are tested in-use.

<sup>252</sup> As explained in Section III.D.1.ii, the final Spark-ignition HDE CO standard for the SET duty-cycle is 14.4 g/hp-hr.

<sup>253</sup> For the EPA Stage 3 engine, the data at the equivalent of 435,000 and 600,000 miles were included in the preamble of the NPRM and the data at the equivalent of 800,000 miles was added to the docket on May 5th, 2022.

<sup>254</sup> Due to the timing of when the data from the System A system were available, the data were added to the public docket prior to the signing of the final rule.



standards of 5 mg/hp-hr for the same reasons outlined for the FTP in Section III.B.2.i. Also similar to the FTP (see Section III.B.2.i), we are finalizing HC and CO SET standards based on the feasibility demonstration for SI engines (see Section III.D).

We have also observed an industry trend toward engine down-speeding—that is, designing engines to do more of their work at lower engine speeds where frictional losses are lower. To better reflect this trend in our duty cycle testing, in the HD GHG Phase 2 final rule we promulgated new SET weighting factors for measuring CO<sub>2</sub> emissions (81 FR 73550, October 25, 2016). Since we believe these new weighting factors better reflect in-use operation of current and future heavy-duty engines, we are finalizing application of these new weighting factors to criteria pollutant measurement, as show in Table III–5, for NO<sub>x</sub> and other criteria pollutants as well. To assess the impact of the new test cycle on criteria pollutant emissions, we analyzed data from the EPA Stage 3 engine that was tested on both versions of the SET. The data summarized in Section III.B.3.ii.a show that the NO<sub>x</sub> emissions from the EPA Stage 3 engine at an equivalent of 435,000 miles are slightly lower using the SET weighting factors in 40 CFR 1036.510 versus the current SET procedure in 40 CFR 86.1362. The lower emissions using the SET cycle weighting factors in 40 CFR 1036.510 are reflected in the stringency of the final SET standards.

TABLE III–5—WEIGHTING FACTORS FOR THE SET

Speed/% load	Weighting factor (%)
Idle .....	12
A, 100 .....	9
B, 50 .....	10
B, 75 .....	10
A, 50 .....	12
A, 75 .....	12
A, 25 .....	12
B, 100 .....	9
B, 25 .....	9
C, 100 .....	2
C, 25 .....	1
C, 75 .....	1
C, 50 .....	1
<b>Total .....</b>	<b>100</b>

<sup>255</sup> California Air Resources Board. “Heavy-Duty Low NO<sub>x</sub> Program Public Workshop: Low Load Cycle Development”. Sacramento, CA. January 23, 2019. Available online: [https://ww3.arb.ca.gov/msprog/hd/lownox/files/workgroup\\_20190123/02-llc\\_ws01232019-1.pdf](https://ww3.arb.ca.gov/msprog/hd/lownox/files/workgroup_20190123/02-llc_ws01232019-1.pdf).

TABLE III–5—WEIGHTING FACTORS FOR THE SET—Continued

Speed/% load	Weighting factor (%)
Idle Speed .....	12
Total A Speed .....	45
Total B Speed .....	38
Total C Speed .....	5

iii. LLC

EPA is finalizing the addition of new standards for testing over the new low-load duty-cycle, that will require CI engine manufacturers to demonstrate that the emission control system maintains functionality during low-load operation where the catalyst temperatures have historically been found to be below the catalyst’s operational temperature (see Chapter 2.2.2 of the RIA). We believe the addition of this LLC will complement the expanded operational coverage of our new off-cycle testing requirements (see Section III.C).

During “Stage 2” of the CARB Low NO<sub>x</sub> Demonstration program, SwRI and NREL developed several candidate cycles with average power and duration characteristics intended to test current diesel engine emission controls under three low-load operating conditions: Transition from high- to low-load, sustained low-load, and transition from low- to high-load.<sup>255</sup> In September 2019, CARB selected the 92-minute “LLC Candidate #7” as the low load cycle they adopted for their Low NO<sub>x</sub> Demonstration program and subsequent Omnibus regulation.<sup>256 257</sup>

We are adopting CARB’s Omnibus LLC as a new duty-cycle, the LLC. This cycle is described in Chapter 2 of the RIA for this rulemaking and the test procedures are specified in 40 CFR 1036.514. The LLC includes applying the accessory loads defined in the HD GHG Phase 2 rule, that were based on data submitted to EPA as part of the development of the HD GHG Phase 2. These accessory loads are 1.5, 2.5 and 3.5 kW for Light HDE, Medium HDE, and Heavy HDE engines, respectively. As detailed further in section 3 of the Response to Comments, we received comments that EPA should revise the accessory loads. One commenter provided specific recommendations for engines installed in tractors but in all

<sup>256</sup> California Air Resources Board. Heavy-Duty Omnibus Regulation. Available online: <https://ww2.arb.ca.gov/rulemaking/2020/hdomnibuslownox>.

<sup>257</sup> California Air Resources Board. “Heavy-Duty Low NO<sub>x</sub> Program: Low Load Cycle” Public Workshop. Diamond Bar, CA. September 26, 2019.

cases commenters didn’t provide data to support their comments; after consideration of these comments and further consideration of the basis of the proposal, we are finalizing the accessory loads for the LLC as proposed. To allow vehicle level technologies to be recognized on this cycle, we are including a powertrain test procedure option for the LLC. More information on the powertrain test procedure can be found in Section III.B.2.v. IRAF determination for the LLC follows the test procedures defined in 40 CFR 1036.580, which are the same test procedures used for the SET and FTP. The IRAF test procedures that apply to the SET and FTP in 40 CFR 1065.680 are appropriate for the LLC as the procedures in 40 CFR 1065.680 were developed to work with any engine-based duty-cycle. We are finalizing as proposed that, while the IRAF procedures in 40 CFR 1036.580 and 1065.680 require that manufacturers determine an IRAF for the SET, FTP, and LLC duty cycles, manufacturers may omit the adjustment factor for a given duty cycle if they determine that infrequent regeneration does not occur over the types of engine operation contained in the duty cycle as described in 40 CFR 1036.580(c).

The final emission standards for the LLC are presented in Table III–6, over the useful life periods shown in Table III–4. The numeric levels of the NO<sub>x</sub> LLC standards at the time of certification are the most stringent proposed for any model year.<sup>258</sup> The numeric level of the PM and CO LLC standards are the same as proposed, and the numeric level of the HC LLC standard is consistent with the proposed Option 1 standard starting in MY 2027. As with the FTP cycle, these standards have been shown to be feasible for compression-ignition engines based on testing of the EPA Stage 3 demonstration engine with chemically- and hydrothermally-aged aftertreatment system, and for the LLC the data shows that the standards are feasible for all engine service classes with available margins between the data and the standards. The summary of this data along with how we addressed compliance margin can be found in Section III.B.3, including discussion of the interim in-use compliance allowance for Medium and Heavy HDEs for determining the interim in-use

Available online: [https://ww3.arb.ca.gov/msprog/hd/lownox/files/workgroup\\_20190926/staff/03\\_llc.pdf](https://ww3.arb.ca.gov/msprog/hd/lownox/files/workgroup_20190926/staff/03_llc.pdf).

<sup>258</sup> As summarized in Section III.A.2 and detailed in this Section III.B we are also finalizing an interim, in-use compliance allowance for medium and heavy heavy-duty engines.

standards for these primary intended service classes.

TABLE III-6—COMPRESSION-IGNITION ENGINE STANDARDS OVER THE LLC DUTY CYCLE

Model year	NO <sub>x</sub> (mg/hp-hr)	PM (mg/hp-hr)	HC (mg/hp-hr)	CO (g/hp-hr)
2027 and later .....	<sup>a</sup> 50	5	140	6.0

<sup>a</sup> An interim NO<sub>x</sub> compliance allowance of 15 mg/hp-hr applies for any in-use testing of Medium HDE and Heavy HDE. Manufacturers will add the compliance allowance to the NO<sub>x</sub> standard that applies for each duty cycle and for off-cycle Bin 2, for both in-use field testing and laboratory testing as described in 40 CFR part 1036, subpart E. Note, the NO<sub>x</sub> compliance allowance doesn't apply to confirmatory testing described in 40 CFR 1036.235(c) or selective enforcement audits described in 40 CFR part 1068.

We are finalizing an LLC PM standard of 5 mg/hp-hr for the same reasons outlined for the FTP in Section III.B.2.i. We are finalizing HC and CO standards based on data from the CARB and EPA Stage 3 engine discussed in Section III.B.3. We are finalizing the same numeric standard for CO on the LLC as we have for the SET and FTP cycles because the demonstration data from the EPA Stage 3 engine shows that CO emissions on the LLC are similar to CO emissions from the SET and FTP. We are finalizing HC standards that are different than the standards of the SET and FTP cycles, to reflect our assessment of the performance of the EPA Stage 3 engine on the LLC. The data discussed in Section III.B.3 of this preamble shows that the PM, HC, and CO standards are feasible for both current and future new engines.

iv. Idle

CARB currently has an optional idle test procedure and accompanying standard of 30 g/hr of NO<sub>x</sub> for diesel engines to be "Clean Idle Certified."<sup>259</sup> In the CARB Omnibus rule, the CARB lowered the optional NO<sub>x</sub> standard to 10 g/hr for MY 2024 to MY 2026 engines and 5 g/hr for MY 2027 and beyond. In the NPRM, we proposed optional NO<sub>x</sub> idle standards with a corresponding idle test procedure, with potentially different numeric levels of the NO<sub>x</sub> idle standards for MY 2023, MY 2024 to MY 2026 engines, and for MY 2027 and beyond, that would allow compression ignition engine manufacturers to voluntarily choose to certify (*i.e.*, it would be optional for a manufacturer to include the idle standard in an EPA certification but once included the idle standard would become mandatory and full compliance would be required). We proposed to require that the brake-specific HC, CO, and PM emissions during the Clean Idle test may not exceed measured emission rates from the idle mode in the SET or the idle segments of the FTP, in addition to

<sup>259</sup> 13 CCR 1956.8(a)(6)(C)—Optional NO<sub>x</sub> idling emission standard.

meeting the applicable idle NO<sub>x</sub> standard. We requested comment on whether EPA should make the idle standards mandatory instead of voluntary for MY 2027 and beyond, as well as whether EPA should set clean idle standards for HC, CO, and PM emissions (in g/hr) rather than capping the idle emissions for those pollutants based on the measured emission levels during the idle mode in the SET or the idle segments of the FTP. We also requested comment on the need for EPA to define a label that would be put on the vehicles that are certified to the optional idle standard.

We received comments on the EPA's proposal to adopt California's Clean Idle NO<sub>x</sub> standard as a voluntary emission standard for Federal certification.<sup>260</sup> All commenters provided general support for EPA's proposal to set idle standards for heavy duty engines, with some qualifications. Some commentors supported making idle standards mandatory, while others commented that the idle standards should be optional. With regard to the level of the idle standard, there was support from many commenters that the standards should be set at the Proposed Option 1 levels or lower, while several manufactures stated that 10 g/hr for certification and 15 g/hr in-use would be the lowest feasible standards for NO<sub>x</sub>. One manufacturer commented that EPA must set standards that do not increase CO<sub>2</sub> emissions. EPA has considered these comments, along with the available data including the data from the EPA Stage 3 engine,<sup>261</sup> and we are finalizing optional idle standards in 40 CFR 1036.104(b) and a new idle test procedure in 40 CFR 1036.525. The standards are based on CARB's test procedure with revisions to not require

<sup>260</sup> See RTC section 3.

<sup>261</sup> See RIA Chapter 3 for a summary of the data collected with the EPA Stage 3 engine run on the Clean Idle test in three configurations. These data show that the MY 2027 and beyond, final NO<sub>x</sub> idle standard of 10 g/hr is feasible through useful life with margin, and show that an additional 5 g/hr in-use margin is not justified.

the measurement of PM, HC and CO,<sup>262</sup> to allow compression-ignition engine manufacturers to voluntarily certify to an idle NO<sub>x</sub> standard of 30.0 g/hr for MY 2024 to MY 2026, which is consistent with proposed Option 1 for MY 2023. For MY 2027 and beyond, the final NO<sub>x</sub> idle standard is 10.0 g/hr, which is the same as proposed Option 2 for those MYs. Manufacturers certifying to the optional idle standard must comply with the standard and related requirements as if they were mandatory.

We received comments stating that the proposed PM, HC, and CO standards are unworkable since the standards are set at the level the engine emits at during idle over the engine SET and FTP duty cycles and that variability in the emissions between the different tests could cause the engine to fail the idle PM, HC, and CO standards. EPA recognized this issue in the proposal and requested comment on if EPA should instead set PM, HC, and CO standards that are fixed and not based on the emissions from the engine during the SET and FTP. EPA has considered these comments and we are not finalizing the proposed requirement to measure brake-specific HC, CO, and PM emissions during the Clean Idle test for comparison to emission rates from the idle modes in the SET or the idle segments of the FTP.<sup>263</sup> The measurement of these additional pollutants would create unnecessary test burden for the manufacturers at this time, especially with respect to measuring PM during idle segments of the SET or FTP as it would require running duplicate tests or adding a PM sampler. Further, setting the PM, HC and CO standards right at the idle emissions level of the engine on the SET and FTP could cause false failures due to test-to-test variability from either the SET or FTP, or the Clean Idle test itself.

<sup>262</sup> 86.1360–2007.B.4, California Exhaust Emission Standards and Test Procedures for 2004 and Subsequent Model Heavy-Duty Diesel Engines and Vehicles, April 18, 2019.

<sup>263</sup> See 40 CFR 1036.104(b).

Idle operation is included as part of off-cycle testing and the SET, FTP, and LLC duty cycles; standards for off-cycle and duty-cycle testing ensure that emissions of HC, CO, and PM are well controlled as aftertreatment temperatures are not as critical to controlling these pollutants over extended idle periods as they are for NO<sub>x</sub>. We are therefore not requiring the measurement of these other pollutants to meet EPA voluntary clean idle standards.

We are finalizing a provision in new 40 CFR 1036.136 requiring engine manufacturers that certify to the Federal Clean Idle NO<sub>x</sub> standard to create stickers to identify their engines as meeting the Federal Clean Idle NO<sub>x</sub> standard. The regulatory provisions require that the stickers meet the same basic requirements that apply for stickers showing that engines meet CARB's Clean Idle NO<sub>x</sub> standard. For example, stickers must be durable and readable throughout each vehicle's operating life, and the preferred placement for Clean Idle stickers is on the driver's side of the hood. Engine manufacturers must provide exactly the right number of these stickers to vehicle manufacturers so they can apply the stickers to vehicles with the engines that the engine manufacturer has certified to meet the Federal Clean Idle NO<sub>x</sub> standard. If engine manufacturers install engines in their own vehicles, they must apply the stickers themselves to the appropriate vehicles. Engine manufacturers must keep the following records for at least five years: (1) Written documentation of the vehicle manufacturer's request for a certain number of stickers, and (2) tracking information for stickers the engine manufacturer sends and the date they sent them. 40 CFR 1036.136 also clarifies that the provisions in 40 CFR 1068.101 apply for the Clean Idle sticker in the same way that those provisions apply for emission control information labels. For example, manufacturing, selling, and applying false labels are all prohibited actions subject to civil penalties.

#### v. Powertrain

EPA recently finalized a separate rulemaking that included an option for manufacturers to certify a hybrid powertrain to the SET and FTP greenhouse gas engine standards by using a powertrain test procedure (86 FR 34321, June 29, 2021).<sup>264</sup> In this rulemaking, we are similarly finalizing

<sup>264</sup> The powertrain test procedure was established in the GHG Phase 1 rulemaking but the recent rulemaking included adjustments to apply the test procedure to the engine test cycles.

as proposed that manufacturers may certify hybrid powertrains to criteria pollutant emissions standards by using the powertrain test procedure. In this section we describe how manufacturers would apply the powertrain test procedure to certify hybrid powertrains.

#### a. Development of Powertrain Test Procedures

Powertrain testing allows manufacturers to demonstrate emission benefits that cannot be captured by testing an engine alone on a dynamometer. For hybrid engines and powertrains, powertrain testing captures when the engine operates less or at lower power levels due to the use of the hybrid powertrain function. However, powertrain testing requires the translation of an engine test procedure to a powertrain test procedure. Chapter 2 of the RIA describes how we translated the SET, FTP, and LLC engine test cycles to the powertrain test cycles.<sup>265</sup> The two primary goals of this process were to make sure that the powertrain version of each test cycle was equivalent to each respective engine test cycle in terms of positive power demand versus time and that the powertrain test cycle had appropriate levels of negative power demand. To achieve this goal, over 40 engine torque curves were used to create the powertrain test cycles.

#### b. Testing Hybrid Engines and Hybrid Powertrains

As noted in the introduction of this Section III, we are finalizing clarifications in 40 CFR 1036.101 that manufacturers may optionally test the hybrid engine and hybrid powertrain to demonstrate compliance. We are finalizing as proposed with one clarification that the powertrain test procedures specified in 40 CFR 1036.510 and 1036.512, which were previously developed for demonstrating compliance with GHG emission standards on the SET and FTP test cycles, are applicable for demonstrating compliance with criteria pollutant standards on the SET and FTP test cycles. The clarification in 40 CFR 1036.510 provides direction that the idle points in the SET should be run as

<sup>265</sup> As discussed in Section III.B.1, as part of the technical amendments rulemaking, EPA finalized that manufacturers may use the powertrain test procedure for GHG emission standards on the FTP and SET engine-based test cycles. In this rulemaking we are extending this to allow the powertrain test procedure to be used for criteria emission standards on these test cycles and the LLC. As discussed in Section 2.ii, we are setting new weighting factors for the engine-based SET procedure for criteria pollutant emissions, which are reflected in the SET powertrain test cycle.

neutral or parked idle. In addition, for GHG emission standards we are finalizing updates to 40 CFR 1036.510 and 1036.512 to further clarify how to carry out the test procedure for plug-in hybrids. We have done additional work for this rulemaking to translate the LLC to a powertrain test procedure, and we are finalizing that manufacturers can similarly certify hybrid engines and hybrid powertrains to criteria pollutant emission standards on the LLC using the test procedures defined in 40 CFR 1036.514.

We are allowing manufacturers to use the powertrain test procedures to certify hybrid engine and powertrain configurations to all MY 2023 and later criteria pollutant engine standards. Manufacturers can choose to use either the SET duty-cycle in 40 CFR 86.1362 or the SET in 40 CFR 1036.510 in model years prior to 2027, and may use only the SET in 40 CFR 1036.510 for model year 2027 and beyond.<sup>266 267</sup>

We are allowing the use of these procedures starting in MY 2023 for plug-in hybrids and, consistent with the requirements for light-duty plug-in hybrids, we are finalizing that the applicable criteria pollutant standards must be met under the worst-case conditions, which is achieved by testing and evaluating emission under both charge-depleting and charge-sustaining operation. This is to ensure that under all drive cycles the powertrain meets the criteria pollutant standards and is not based on an assumed amount of zero emissions range. We received comment stating that the charge-depleting and charge-sustaining operation should be weighted together for criteria pollutants as well as GHG pollutants, but consistent with the light-duty test procedure we want to ensure that criteria pollutant emissions are controlled under all conditions, which would include under conditions where the vehicle is not charged and is only operated in charge sustaining-operation.

We are finalizing changes to the test procedures defined in 40 CFR 1036.510 and 1036.512 to clarify how to weight together the charge-depleting and charge-sustaining greenhouse gas emissions for determining the greenhouse gas emissions of plug-in

<sup>266</sup> We are allowing either the SET duty-cycle in 40 CFR 86.1362 or 40 CFR 1036.505 because the duty cycles are similar and, as shown in Chapter 3.1.2 of the RIA, the criteria pollutant emissions level of current production engines is similar between the two cycles.

<sup>267</sup> Prior to MY 2027, only manufacturers choosing to participate in the 2026 Service Class Pull Ahead Credits, Full Credits, or Partial Credits pathways under the Transitional Credits Program need to conduct LLC powertrain testing (see Section IV.G for details on).

hybrids for the SET and FTP duty cycles. This weighting is done using an application specific utility factor curve that is approved by EPA. We are also finalizing a provision to not apply the cold and hot weighting factors for the determination of the FTP composite emission result for greenhouse gas pollutants because the charge-depleting and sustaining test procedures finalized in 40 CFR 1036.512 include both cold and hot start emissions by running repeat FTP cycles back-to-back. By running back-to-back FTPs, the finalized test procedure captures both cold and hot emissions and their relative contribution to daily greenhouse gas emissions per unit work, removing the need for weighting the cold and hot emissions.

We are finalizing the application of the powertrain test procedure only for hybrid powertrains, to avoid having two different testing pathways (engine only and powertrain) for non-hybrid engines for the same standards. That said, we recognize there may be other technologies where the emissions performance is not reflected on the engine test procedures, so in such cases manufacturers may seek approval from EPA to use the powertrain test procedure for non-hybrid engines and powertrains consistent with 40 CFR 1065.10(c)(1).

Finally, for all pollutants, we requested comment on if we should remove 40 CFR 1037.551 or limit the use of it to only selective enforcement audits (SEAs). 40 CFR 1037.551 was added as part of the HD GHG Phase 2 rulemaking to provide flexibility for an SEA or a confirmatory test, by allowing just the engine of the powertrain to be tested. Allowing just the engine to be tested over the engine speed and torque cycle that was recorded during the powertrain test enables the testing to be conducted in more widely available engine dynamometer test cells, but this flexibility could increase the variability of the test results. We didn't receive any comments on this topic and, for the reason just stated, we are limiting the use of 40 CFR 1037.551 to SEA testing.

#### vi. Crankcase Emissions

During combustion, gases can leak past the piston rings sealing the cylinder and into the crankcase. These gases are called blowby gases and generally include unburned fuel and other combustion products. Blowby gases that escape from the crankcase are considered crankcase emissions (see 40 CFR 86.402–78). Current regulations restrict the discharge of crankcase emissions directly into the ambient air. Blowby gases from gasoline engine

crankcases have been controlled for many years by sealing the crankcase and routing the gases into the intake air through a PCV valve. However, in the past there have been concerns about applying a similar technology for diesel engines. For example, high PM emissions venting into the intake system could foul turbocharger compressors. As a result of this concern, diesel-fueled and other compression-ignition engines equipped with turbochargers (or other equipment) were not required to have sealed crankcases (see 40 CFR 86.007–11(c)). For these engines, manufacturers were allowed to vent the crankcase emissions to ambient air as long as they are measured and added to the exhaust emissions during all emission testing to ensure compliance with the emission standards.

Because all new highway heavy-duty diesel engines on the market today are equipped with turbochargers, they are not required to have closed crankcases under the current regulations. We estimate approximately one-third of current highway heavy-duty diesel engines have closed crankcases, indicating that some heavy-duty engine manufacturers have developed systems for controlling crankcase emissions that do not negatively impact the turbocharger. EPA proposed provisions in 40 CFR 1036.115(a) to require a closed crankcase ventilation system for all highway compression-ignition engines to prevent crankcase emissions from being emitted directly to the atmosphere starting for MY 2027 engines.<sup>268</sup> Comments were received regarding concerns closing the crankcase that included coking, degraded performance and turbo efficiencies leading to increased CO<sub>2</sub> emissions, secondary damage to components, and increased engine-out PM (see section 3 of the Response to Comments document for further details). After considering these comments, we are finalizing a requirement for manufacturers to use one of two options for controlling crankcase emissions, either: (1) As proposed, closing the crankcase, or (2) an updated version of the current requirements for an open crankcase that includes additional requirements for measuring and accounting for crankcase emissions. We believe that either approach is appropriate, so long as the total emissions are accounted for during certification and in-use testing through

<sup>268</sup> We proposed to move the current crankcase emissions provisions to a new paragraph (u) in the interim provisions of 40 CFR 1036.150, which would apply through model year 2026.

useful life (including full accounting for crankcase emission deterioration).

#### a. Closed Crankcase Option

As EPA explained at proposal, the environmental advantages to closing the crankcase are twofold. While the exception in the current regulations for certain compression-ignition engines requires manufacturers to quantify their engines' crankcase emissions during certification, they report non-methane hydrocarbons in lieu of total hydrocarbons. As a result, methane emissions from the crankcase are not quantified. Methane emissions from diesel-fueled engines are generally low; however, they are a concern for compression-ignition-certified natural gas-fueled heavy-duty engines because the blowby gases from these engines have a higher potential to include significant methane emissions. We note that in the HD GHG Phase 2 rule we set methane standards which required natural gas engines to close the crankcase in order to comply with the methane standard. EPA proposed to require that all natural gas-fueled engines have closed crankcases in the HD GHG Phase 2 rulemaking, but opted to wait to finalize any updates to regulations in a future rulemaking, where we could then propose to apply these requirements to natural gas-fueled engines and to the diesel fueled engines that many of the natural gas-fueled engines are based off of (81 FR 73571, October 25, 2016).

In addition to our concern of unquantified methane emissions, we believe another benefit to closed crankcases would be reduced engine wear due to improved engine component durability. We know that the performance of piston seals reduces as the engine ages, which would allow more blowby gases and could increase crankcase emissions. While crankcase emissions are currently included in the durability tests that estimate an engine's deterioration at useful life, those tests were not designed to capture the deterioration of the crankcase. These unquantified age impacts continue throughout the operational life of the engine. Closing crankcases could be a means to ensure those emissions are addressed long-term to the same extent as other exhaust emissions.

After considering all of the manufacturer concerns, we still believe, noting that one-third of current highway heavy-duty diesel engines have closed crankcases, that improvements in the design of engine hardware would allow manufacturers to close the crankcase, with the potential for increased maintenance intervals on some

components. For these reasons, EPA is finalizing provisions in 40 CFR 1036.115(a) to require a closed crankcase ventilation system as one of two options for all highway compression-ignition engines to control crankcase emissions for MY 2027 and later engines.

#### b. Open Crankcase Option

Given consideration of the concerns from commenters regarding engine hardware durability associated with closing the crankcase, we have decided to finalize an option that allows the crankcase to remain open. This option requires manufacturers of compression ignition engines that choose to leave the crankcase open to account for any increase in the contribution of crankcase emissions (due to reduction in performance of piston seals, etc.) to the total emissions from the engine throughout the engine's useful life. Manufacturers that choose to perform engine dynamometer-based testing out to useful life will provide a deterioration factor that includes deteriorated crankcase emissions because the engine components will be aged out to the engine's useful life. Manufacturers that choose to use the accelerated aging option in 40 CFR 1036.245(b), where the majority of the emission control system aging is done, must use good engineering judgment to determine the impact of engine deterioration on crankcase emissions and adjust the tailpipe emissions at useful life to reflect this deterioration. For example, manufacturers may determine deteriorated crankcase emissions from the assessment of field-aged engines.

Manufacturers who choose this option must also account for crankcase criteria pollutant emissions during any manufacturer run in-use testing to determine the overall compliance of the engine as described in 40 CFR 1036.415(d)(2). The crankcase emissions must be measured separately from the tailpipe emissions or be routed into the exhaust system, downstream from the last catalyst in the aftertreatment system, to ensure that there is proper mixing of the two streams prior to the sample point. In lieu of these two options, manufacturers may use the contribution of crankcase emissions over the FTP duty-cycle at useful life from the deterioration factor determination testing in 40 CFR 1036.245, as described in 40 CFR 1036.115(a) and add them to the binned emission results determined in 40 CFR 1036.530.

Chapter 1.1.4 of the RIA describes EPA's recent test program to evaluate

the emissions from open crankcase systems on two modern heavy-duty diesel engines. Results suggest HC and CO emitted from the crankcase can be a notable fraction of overall tailpipe emissions. By closing the crankcase, those emissions would be rerouted to the engine or aftertreatment system to ensure control of the crankcase emissions. If a manufacturer chooses the option to keep the crankcase open, overall emission control will still be achieved, but the manufacturer will have to design and optimize the emission control system for lower tailpipe emissions to offset the emissions from the crankcase as the total emissions are accounted for both in-use and at useful life.

### 3. Feasibility of the Diesel (Compression-Ignition) Engine Standards

#### i. Summary of Technologies Considered

Our finalized standards for compression-ignition engines are based on the performance of technology packages described in Chapters 1 and 3 of the RIA for this rulemaking. Specifically, we are evaluating the performance of next-generation catalyst formulations in a dual SCR catalyst configuration with a smaller SCR catalyst as the first substrate in the aftertreatment system for improved low-temperature performance, and a larger SCR catalyst downstream of the diesel particulate filter to improve NO<sub>x</sub> conversion efficiency during high power operation and to allow for passive regeneration of the particulate filter.<sup>269</sup> Additionally, the technology package includes CDA that reduces the number of active cylinders, resulting in increased exhaust temperatures for improved catalyst performance under light-load conditions and can be used to reduce fuel consumption and CO<sub>2</sub> emissions. The technology package also includes the use of a heated DEF injector for the upfront SCR catalyst; the heated DEF injector allows DEF injection at temperatures as low as approximately 140°C. The heated DEF injector also improves the mixing of DEF and exhaust gas within a shorter distance than with unheated DEF injectors, which enables the aftertreatment system to be packaged in a smaller space. Finally, the technology package includes hardware needed to close the crankcase of diesel engines.

<sup>269</sup> As described in Chapter 3 of the RIA, we are evaluating 3 different aftertreatment systems that contain different catalyst formulation.

#### ii. Summary of Feasibility Analysis

##### a. Projected Technology Package Effectiveness and Cost

Based upon data from EPA's and CARB's Stage 3 Heavy-duty Low NO<sub>x</sub> Research Programs (see Chapter 3.1.1.1 and Chapter 3.1.3.1 of the RIA), an 80 percent reduction in the Heavy HDE NO<sub>x</sub> standard as compared to the current NO<sub>x</sub> standard is technologically feasible when using CDA or other valvetrain-related air control strategies in combination with dual SCR systems, and closed crankcase. As noted in the proposal, EPA continued to evaluate aftertreatment system durability via accelerated aging of advanced emissions control systems as part of EPA's diesel engine demonstration program that is described in Chapter 3 of the RIA. In assessing the technical feasibility of each of our final standards, we have taken into consideration the emissions of the EPA Stage 3 engine and other available data, the additional emissions from infrequent regenerations, the final longer useful life, test procedure variability, emissions performance of other child engines in an engine family, production and engine variability, fuel and DEF quality, sulfur, soot and ash levels on the aftertreatment, aftertreatment aging due to severe-service operation, aftertreatment packaging and lead time for manufacturers.

Manufacturers are required to design engines that meet the duty cycle and off-cycle standards throughout the engines' useful life. In recognition that emissions performance will degrade over time, manufacturers generally design their engines to perform significantly better than the standards when first sold to ensure that the emissions are below the standard throughout useful life even as the emissions controls deteriorate. As discussed in this section and in Chapter 3 of the RIA and shown in Table III-12 and Table III-13, some manufacturers have submitted certification data with zero emissions (with rounding), which results in a margin at 100 percent of the FEL, while other manufacturers have margin that is less than 25 percent of the FEL.

To assess the feasibility of the final MY 2027 standards for Light, Medium, and Heavy HDE at the corresponding final useful lives, EPA took into consideration and evaluated the data from the EPA Stage 3 engine as well as other available data and comments received on the proposed standards. See section 3 of the Response to Comment document for further information on the comments received and EPA's detailed response.

As discussed in Section III.B.2, the EPA Stage 3 engine includes improvements beyond the CARB Stage 3 engine, namely replacing the zone-coated catalyzed soot filter with a separate DOC and DPF and improving the mixing of the DEF with exhaust for the downstream SCR catalyst. These improvements lowered the emissions on the SET, FTP, and LLC below what was measured with the CARB Stage 3 engine. The emissions for the EPA Stage 3 engine on the SET, FTP, and LLC aged to an equivalent of 435,000, 600,000 and 800,000 miles are shown in Table III-7, Table III-8, and Table III-9. To account for the IRAF for both particulate matter and sulfur on the aftertreatment system, we assessed and determined it was appropriate to rely on an analysis by SwRI that is summarized in Chapter 3 of the RIA. In this analysis SwRI determined that IRAF NO<sub>x</sub> emissions were at 2 mg/hp-hr for both the SET and FTP cycles and 5 mg/hp-hr for the LLC. To account for the crankcase emissions, we assessed and determined it was appropriate to rely on an analysis by SwRI that is summarized in Chapter 3 of the RIA. In this analysis, SwRI determined that the NO<sub>x</sub> emissions from the crankcase were at 6 mg/hp-hr for the LLC, FTP, and SET cycles.

To determine whether or how to account for the effects of test procedure variability, emissions performance of other ratings in an engine family, production and engine variability, fuel and DEF quality, sulfur, soot and ash levels on the aftertreatment, aftertreatment aging due to severe-service operation, and aftertreatment packaging—and given the low level of the standards under consideration—EPA further assessed two potential approaches after taking into consideration comments received. The first approach considered was assigning standard deviation and offsets to each of these effects and then combining them using a mathematical method similar to what one commenter presented in their comments to the NPRM.<sup>270</sup> The second approach considered was defining the margin as a percentage of the standards, similar to assertions by two commenters. We considered both of these approaches, the comments and supporting information submitted, historical approaches by EPA to compliance margin in previous heavy-duty criteria pollutant standards rules, and the data collected from the EPA Stage 3 engine and other available data, to determine the numeric level of each

standard over the corresponding useful life that is technically feasible.

For the first approach, we determined that a minimum of 15 mg/hp-hr of margin between an emission standard and the NO<sub>x</sub> emissions of the EPA Stage 3 engine for each of the duty cycles was appropriate.<sup>271</sup> For the second approach, we first assessed the average emissions rates from the EPA Stage 3 engine at the respective aged miles. For Light HDEs, we looked at the data at the equivalent of 435,000 miles. For the Medium and Heavy HDEs standards the interpolated emissions performance at 650,000 miles was determined from the tests at the equivalent of 600,000 and 800,000 miles, which is shown in Table III-10.<sup>272</sup> Second, the average emissions values were then adjusted to account for the IRAF and crankcase emissions from the EPA Stage 3 engine. Third, we divided the adjusted emissions values by 0.55 to calculate an emission standard that would provide 45 percent margin to the standard. We determined it would be appropriate to apply a 45 percent margin in this case after evaluating the margin in engines that meet the current standards as outlined in RIA chapter 3 and in CARB's comment to the NPRM and considering the level of the standards in this final rule. Our determination is based on our analysis that the certification data from engines meeting today's standards shows that more than 80 percent of engine families are certified with less than 45 percent compliance margin. For Light HDEs, we took the resulting values from the third step of our approach and rounded them. EPA then also checked that each of these values for each of the duty cycles (resulting from the second approach) provided a minimum of 15 mg/hp-hr of margin between those values and the NO<sub>x</sub> emissions of the EPA Stage 3 engine (consistent with the first approach). For Light HDEs, we determined those resulting values were appropriate final numeric emission standards (as specified in Preamble Section III.B.2). The last step of checking that the Light HDE standards provide a minimum of 15 mg/hp-hr of NO<sub>x</sub> margin was to ensure that the margin determined from the percent of

the standard (the second approach to margin) also provided the margin that we determined under the first approach to margin. For Light HDEs, given the level of the final standards and the length of the final useful life mileages, we determined that this approach to margin was appropriate for both certification and in-use testing of engines.

Given the very long useful life mileages for Heavy HDE and greater amounts of certain aging mechanisms over the long useful life periods of Medium HDE, we determined that a different application of considering these two approaches to margin was appropriate. The in-use standards of Medium and Heavy HDEs were determined using the second approach for determining margin. The certification standards were then determined by subtracting the margin from the first approach (15 mg/hp-hr) from the in-use standards.

Separating the standards from the level that applies for in-use testing was appropriate because we recognize that laboratory aging of the engine doesn't fully capture all the sources of deterioration of the aftertreatment that can occur once the engine enters the real-world and those uncertainties would be most difficult for these engine classes at the level of the final standards and the final useful life mileages. Some of these effects are SCR sulfation, fuel quality, DEF quality, sensor variability, and field aging from severe duty cycles. Thus, the last step in determining the standards for Medium and Heavy HDE was to subtract the 15 mg/hp-hr from the rounded value that provided 45 percent margin to the Stage 3 data. We determined each of the resulting final duty cycle NO<sub>x</sub> standards for Medium and Heavy HDE that must be demonstrated at the time of certification out to 350,000 and 750,000 miles, respectively, are feasible with enough margin to account for test procedure variability. We determined this by comparing the EPA Stage 3 emissions results at 800,000 miles (Table III-9) after adjusting for IRAF and crankcase emissions to each of the NO<sub>x</sub> standards in Section III.B.2. The EPA Stage 3 NO<sub>x</sub> emissions results at 800,000 miles adjusted for IRAF and crankcase emissions are 26 mg/hp-hr for the SET, 33 mg/hp-hr for the FTP, and 33 mg/hp-hr for the LLC. For any in-use testing of Medium and Heavy HDEs, a 15 mg/hp-hr compliance allowance is added to the applicable standard, in consideration of the other sources of variability and deterioration of the aftertreatment that can occur once the engine enters the real world.

<sup>271</sup> See RIA Chapter 3 for the details on how the margin of 15 mg/hp-hr was defined.

<sup>272</sup> See RIA Chapter 3.1.1.2 for additional information on why each aging test point was used for each primary intended service class. We note that we received data claimed as confidential business information from a manufacturer on August 2, 2022, and considered that data as part of this assessment to use the EPA Stage 3 data at the equivalent of 650,000 miles for setting the Medium HDE standards. The data were added to the docket prior to the signing of the final rule. See also U.S. EPA. Stakeholder Meeting Log. December, 2022.

<sup>270</sup> See RIA Chapter 3 for the details on this analysis.

As explained in the proposal, our technology cost analysis included an increased SCR catalyst volume from what was used on the EPA and CARB Stage 3 engines. By increasing the SCR catalyst volume, the NO<sub>x</sub> reduction performance of the aftertreatment system should deteriorate slower than what was demonstrated with the EPA Stage 3 engine. The increase in total SCR catalyst volume relative to the EPA and CARB Stage 3 SCR was

approximately 23.8 percent. We believe this further supports our conclusion that the final standards are achievable in MY 2027, including for the final useful life of 650,000 miles for Heavy HDEs. In addition to NO<sub>x</sub>, the final HC and CO standards are feasible for CI engines on all three cycles. This is shown in Table III–10, where the demonstrated HC and CO emission results are below the final standards discussed in Section III.B.2. The final standard for PM of 5 mg/hp-

hr for the SET, FTP, and LLC continue to be feasible with the additional technology and control strategies needed to meet the final NO<sub>x</sub> standards, as seen by the PM emissions results in Table III–10. As discussed in Section III.B.2, taking into account measurement variability of the PM measurement test procedure, we believe PM emissions from current diesel engines are at the lowest feasible level for standards starting in MY 2027.

TABLE III–7—STAGE 3 ENGINE EMISSIONS AT 435,000 MILE EQUIVALENT TEST POINT WITHOUT ADJUSTMENTS FOR IRAF OR CRANKCASE EMISSIONS

Duty cycle	NO <sub>x</sub> (mg/hp-hr)	PM (mg/hp-hr)	NMHC (nonmethane hydrocarbon) (mg/hp-hr)	CO (g/hp-hr)	CO <sub>2</sub> (g/hp-hr)	N <sub>2</sub> O (g/hp-hr)
SET <sup>a</sup> .....	17	1	1	0.030	455	0.024
FTP .....	20	2	12	0.141	514	0.076
LLC .....	29	3	35	0.245	617	0.132

<sup>a</sup> Using the weighting factors in our finalized test procedures (40 CFR 1036.510).

TABLE III–8—STAGE 3 ENGINE EMISSIONS AT 600,000 MILE EQUIVALENT TEST POINT WITHOUT ADJUSTMENTS FOR IRAF OR CRANKCASE EMISSIONS

Duty cycle	NO <sub>x</sub> (mg/hp-hr)	PM (mg/hp-hr)	NMHC (mg/hp-hr)	CO (g/hp-hr)	CO <sub>2</sub> (g/hp-hr)	N <sub>2</sub> O (g/hp-hr)
SET <sup>a</sup> .....	24	1	1	0.015	460	0.030
FTP .....	27	1	9	0.144	519	0.058
LLC .....	33	4	16	0.153	623	0.064

<sup>a</sup> Using the weighting factors in our finalized test procedures (40 CFR 1036.510).

TABLE III–9—STAGE 3 ENGINE EMISSIONS AT 800,000 MILE EQUIVALENT TEST POINT WITHOUT ADJUSTMENTS FOR IRAF OR CRANKCASE EMISSIONS

Duty cycle	NO <sub>x</sub> (mg/hp-hr)	PM (mg/hp-hr)	NMHC (mg/hp-hr)	CO (g/hp-hr)	CO <sub>2</sub> (g/hp-hr)	N <sub>2</sub> O (g/hp-hr)
SET <sup>a</sup> .....	30	2	1	0.023	458	0.028
FTP .....	37	1	14	0.149	520	0.092
LLC .....	34	1	40	0.205	629	0.125

<sup>a</sup> Using the weighting factors in our finalized test procedures (40 CFR 1036.510).

TABLE III–10—STAGE 3 ENGINE EMISSIONS AT INTERPOLATED AT 650,000 MILE EQUIVALENT WITHOUT ADJUSTMENTS FOR IRAF OR CRANKCASE EMISSIONS

Duty cycle	NO <sub>x</sub> (mg/hp-hr)	PM (mg/hp-hr)	NMHC (mg/hp-hr)	CO (g/hp-hr)	CO <sub>2</sub> (g/hp-hr)	N <sub>2</sub> O (g/hp-hr)
SET <sup>a</sup> .....	26	1	1	0.017	460	0.030
FTP .....	30	1	10	0.145	519	0.067
LLC .....	33	3	22	0.166	625	0.079

<sup>a</sup> Using the weighting factors in our finalized test procedures (40 CFR 1036.510).

In addition to evaluating the feasibility of the new criteria pollutant standards, we also evaluated how CO<sub>2</sub> was impacted on the CARB Stage 3 engine (which is the same engine that was used for EPA’s Stage 3 engine with modifications to the aftertreatment system and engine calibration to lower

NO<sub>x</sub> emissions). We did this by evaluating how CO<sub>2</sub> emissions changed from the base engine over the SET, FTP, and LLC, as well as the fuel mapping test procedures defined in 40 CFR 1036.535 and 1036.540. For all three cycles the CARB Stage 3 engine emitted CO<sub>2</sub> with no measurable difference

compared to the base 2017 Cummins X15 engine. Specifically, we compared the CARB Stage 3 engine including the 0-hour (degreened) aftertreatment with the 2017 Cummins X15 engine including degreened aftertreatment and found the percent reduction in CO<sub>2</sub> was

0 percent for the SET, 1 percent for the FTP, and 1 percent for the LLC.<sup>273</sup>

We note that while the data from the EPA Stage 3 engine (the same engine as the CARB Stage 3 engine but after SwRI made changes to the thermal management strategies) at the equivalent age of 435,000 miles showed an increase in CO<sub>2</sub> emissions for the SET, FTP, and LLC of 0.6, 0.7 and 1.3 percent respectively, which resulted in the CO<sub>2</sub> emissions for the EPA Stage 3 engine being higher than the 2017 Cummins X15 engine, this is not directly comparable because the baseline 2017 Cummins X15 aftertreatment had not been aged to an equivalent of 435,000 miles.<sup>274</sup> As discussed in Chapter 3 of the RIA, aging the EPA Stage 3 engine included exposing the aftertreatment to ash, that increased the back pressure on the engine, which contributed to the increase in CO<sub>2</sub> emissions from the EPA Stage 3 engine. We would expect the same increase in backpressure and in CO<sub>2</sub> emissions from the 2017 Cummins X15 engine if the aftertreatment of the 2017 Cummins X15 engine was aged to an equivalent of 435,000 miles.

To evaluate how the technology on the CARB Stage 3 engine compares to the 2017 Cummins X15 engine with respect to the HD GHG Phase 2 vehicle CO<sub>2</sub> standards, both engines were tested on the fuel mapping test procedures defined in 40 CFR 1036.535 and 1036.540. These test procedures define how to collect the fuel consumption data from the engine for use in GEM. For these tests the CARB Stage 3 engine was tested with the development aged

aftertreatment.<sup>275</sup> The fuel maps from these tests were run in GEM and the results from this analysis showed that the EPA and CARB Stage 3 engine emitted CO<sub>2</sub> at the same rate as the 2017 Cummins X15 engine. The details of this analysis are described in Chapter 3.1 of the RIA.

The technologies included in the EPA Stage 3 engine were selected to both demonstrate the lowest criteria pollutant emissions and have a negligible effect on GHG emissions. Manufacturers may choose to use other technologies to meet the final standards, but manufacturers will still also need to comply with the GHG standards that apply under HD GHG Phase 2. We have, therefore, not projected an increase in GHG emissions resulting from compliance with the final standards.

Table III–11 summarizes the incremental direct manufacturing costs for the final standards, from the baseline costs shown in Table III–15. These values include aftertreatment system, closed crankcase, and CDA costs. As discussed in Chapter 7 of the RIA, the direct manufacturing costs include the technology costs plus some costs to improve the durability of the technology through regulatory useful life. The details of this analysis can be found in Chapters 3 and 7 of the RIA.<sup>276</sup> The cost of the final standards and useful life periods are further accounted for in the indirect costs as discussed in Chapter 7 of the RIA.<sup>277</sup>

TABLE III–11—INCREMENTAL DIRECT MANUFACTURING COST OF FINAL STANDARDS FOR THE AFTERTREATMENT, CLOSED CRANKCASE, AND CDA TECHNOLOGY [2017 \$]

Light HDE	Medium HDE	Heavy HDE	Urban bus
\$1,957 ...	\$1,817	\$2,316	\$1,850

b. Baseline Emissions and Cost

The basis for our baseline technology assessment is the data provided by manufacturers in the heavy-duty in-use testing program. This data encompasses in-use operation from nearly 300 Light HDE, Medium HDE, and Heavy HDE vehicles. Chapter 5 of the RIA describes how the data was used to update the MOVES model emissions rates for HD diesel engines. Chapter 3 of the RIA summarizes the in-use emissions performance of these engines.

We also evaluated the certification data submitted to the agency. The data includes test results adjusted for IRAF and FEL that includes adjustments for deterioration and margin. The certification data, summarized in Table III–12 and Table III–13, shows that manufacturers vary in their approach to how much margin is built into the FEL. Some manufactures have submitted certification data with zero emissions (with rounding), which results in a margin at 100 percent of the FEL, while other manufacturers have margin that is less than 25 percent of the FEL.

TABLE III–12—SUMMARY OF CERTIFICATION DATA FOR FTP CYCLE

	NO <sub>x</sub> (g/hp-hr)	PM (g/hp-hr)	NMHC (g/hp-hr)	CO (g/hp-hr)	N <sub>2</sub> O (g/hp-hr)
Average .....	0.13	0.00	0.01	0.18	0.07
Minimum .....	0.05	0.00	0.00	1.00	0.04
Maximum .....	0.18	0.00	0.04	1.10	0.11

TABLE III–13—SUMMARY OF CERTIFICATION DATA FOR SET CYCLE

	NO <sub>x</sub> (g/hp-hr)	PM (g/hp-hr)	NMHC (g/hp-hr)	CO (g/hp-hr)	N <sub>2</sub> O (g/hp-hr)
Average .....	0.11	0.00	0.01	0.00	0.06
Minimum .....	0.00	0.00	0.00	0.00	0.00
Maximum .....	0.18	0.00	0.04	0.20	0.11

<sup>273</sup> See Chapter 3 of the RIA for the CO<sub>2</sub> emissions of the 2017 Cummins X15 engine and the CARB Stage 3 engine.

<sup>274</sup> As part of the agency's diesel demonstration program, we didn't age the aftertreatment of the base 2017 Cummins X15 engine since the focus of this program was to demonstrate emissions performance of future technologies and due to

resource constraints. Thus, there isn't data directly comparable to the baseline engine at each aging step.

<sup>275</sup> The CARB Stage 3 0-hour (degreened) aftertreatment could not be used for these tests, because it had already been aged past the 0-hour point when these tests were conducted.

<sup>276</sup> See RIA Chapter 3 for the details of the cost for the aftertreatment and CDA, which are the drivers for why the incremental direct manufacturing cost is lowest for Medium HDE.

<sup>277</sup> See Table III–3 for the final useful life values and Section IV.B.1 for the final emissions warranty periods.



In addition to analyzing the on-cycle certification data submitted by manufacturers, we tested three modern HD diesel engines on an engine dynamometer and analyzed the data. These engines were a 2018 Cummins B6.7, 2018 Detroit DD15 and 2018

Navistar A26. These engines were tested on cycles that range in power demand from the creep mode of the Heavy Heavy-Duty Diesel Truck (HHDDT) schedule to the HD SET cycle defined in 40 CFR 1036.510. Table III–14 summarizes the range of results from

these engines on the SET, FTP, and LLC. As described in Chapter 3 of the RIA, the emissions of current production heavy-duty engines vary from engine to engine but the largest difference in NO<sub>x</sub> between engines is seen on the LLC.

TABLE III–14—RANGE OF NO<sub>x</sub> EMISSIONS FROM MY2018 HEAVY-DUTY DIESEL ENGINES

NO <sub>x</sub> (g/hp-hr)	SET in 40 CFR 86.1333	SET in 40 CFR 1036.510	FTP composite	LLC
Minimum .....	0.01	0.01	0.10	0.35
Maximum .....	0.12	0.05	0.15	0.81
Average .....	0.06	0.03	0.13	0.59

Table III–15 summarizes the baseline sales-weighted total aftertreatment cost

of Light HDEs, Medium HDEs, Heavy HDEs and urban bus engines. The

details of this analysis can be found in Chapters 3 and 7 of the RIA.

TABLE III–15—BASELINE DIRECT MANUFACTURING AFTERTREATMENT COST [2017 \$]

Light HDE	Medium HDE	Heavy HDE	Urban bus
\$2,585 .....	\$2,536	\$3,761	\$2,613

*C. Summary of Compression-Ignition Off-Cycle Standards and Off-Cycle Test Procedures*

In this Section 0, we describe the final off-cycle standards and test procedures that will apply for model year 2027 and later heavy-duty compression-ignition engines. The final off-cycle standards and test procedures cover the range of operation included in the duty cycle test

procedures and operation that is outside of the duty cycle test procedures for each regulated pollutant (NO<sub>x</sub>, HC, CO, and PM). As described in Section III.C.1, our current not-to-exceed (NTE) test procedures were not designed to capture and control low-load operation. In contrast to the current NTE approach that evaluates engine operation within the NTE zone and excludes operation out of the NTE zone, we are finalizing

a moving average window (MAW) approach that divides engine operation into two categories (or “bins”) based on the time-weighted average engine power of each MAW of engine data. See Section III.C.2 for a discussion of the derivation of the final off-cycle standards for each bin. For bin 1, the NO<sub>x</sub> emission standard is 10.0 g/hr. The final off-cycle standards for bin 2 are shown in Table III–16.

TABLE III–16—FINAL OFF-CYCLE BIN 2 STANDARDS FOR LIGHT HDE, MEDIUM HDE, AND HEAVY HDE

NO <sub>x</sub> (mg/hp-hr)	HC (mg/hp-hr)	PM (mg/hp-hr)	CO (g/hp-hr)
58 <sup>a</sup> .....	120	7.5	9

<sup>a</sup> An interim NO<sub>x</sub> compliance allowance of 15 mg/hp-hr applies for any in-use testing of Medium HDE and Heavy HDE. Manufacturers will add the compliance allowance to the NO<sub>x</sub> standard that applies for each duty cycle and for off-cycle testing, with both field testing and laboratory testing.

The proposed rule provided an extensive discussion of the rationale and information supporting the proposed off-cycle standards (87 FR 17472, March 28, 2022). Chapters 2 and 3 of the RIA include additional information including background on applicable test procedures and the full feasibility analysis for compression-ignition engines. See also section 11.3 of the Response to Comments for a detailed discussion of the comments and how they have informed this final rule.

Heavy-duty CI engines are currently subject to Not-To-Exceed (NTE) standards that are not limited to specific test cycles, which means they can be evaluated not only in the laboratory but also in-use. NTE standards and test procedures are generally referred to as “off-cycle” standards and test procedures. These off-cycle emission standards are 1.5 (1.25 for CO) times the laboratory certification standard for NO<sub>x</sub>, HC, PM and CO and can be found in 40 CFR 86.007–11.<sup>278</sup> NTE standards have been successful in broadening the

types of operation for which manufacturers design their emission controls to remain effective, including steady cruise operation. However, there remains a significant proportion of vehicle operation not covered by NTE standards.

averaging, banking, and trading program agree to meet the family emissions limit (FEL) declared whenever the engine is tested over the applicable duty- or off-cycle test procedure. The FELs serves as the emission standard for compliance testing instead of the standards specified in 40 CFR 86.007–11 or 40 CFR 1036.104(a); thus, the existing off-cycle standards are 1.5 (1.25 for CO) times the FEL for manufacturers who choose to participate in ABT.

1. Existing NTE Standards and Need for Changes to Off-Cycle Test Procedures

<sup>278</sup> As noted in Section IV.G, manufacturers choosing to participate in the existing or final

Compliance with an NTE standard is based on emission test data (whether collected in a laboratory or in use) analyzed pursuant to 40 CFR 86.1370 to identify NTE events, which are intervals of at least 30 seconds when engine speeds and loads remain in the NTE control area or “NTE zone”. The NTE zone excludes engine operation that falls below certain torque, power, and speed values.<sup>279</sup> The NTE procedure also excludes engine operation that occurs in certain ambient conditions (*i.e.*, high altitudes, high intake manifold humidity), or when aftertreatment temperatures are below 250 °C. Collected data is considered a valid NTE event if it occurs within the NTE zone, lasts at least 30 seconds, and does not occur during any of the exclusion conditions (ambient conditions or aftertreatment temperature).

The purpose of the NTE test procedure is to measure emissions during engine operation conditions that could reasonably be expected to occur during normal vehicle use; however, only data in a valid NTE event is then compared to the NTE emission standard. Our analysis of existing heavy-duty in-use vehicle test data indicates that less than ten percent of a typical time-based dataset are part of valid NTE events, and hence subject to the NTE standards; the remaining test data are excluded from consideration. We also found that emissions are high during many of the excluded periods of operation, such as when the aftertreatment temperature drops below the 250 °C exclusion criterion. Our review of in-use data indicates that extended time at low load and idle operation results in low aftertreatment temperatures, which in turn lead to diesel engine SCR-based emission control systems not functioning over a significant fraction of real-world operation.<sup>280 281 282</sup> Test data collected as part of EPA’s manufacturer-run in-use testing program indicate that low-load operation could account for greater

than 50 percent of the NO<sub>x</sub> emissions from a vehicle over a given workday.<sup>283</sup>

For example, 96 percent of tests in response to 2014, 2015, and 2016 EPA in-use testing orders passed with NO<sub>x</sub> emissions for valid NTE events well below the 0.3 g/hp-hr NO<sub>x</sub> NTE standard. When we used the same data to calculate NO<sub>x</sub> emissions over all operation measured, not limited to valid NTE events, the NO<sub>x</sub> emissions were more than double those within the valid NTE events (0.5 g/hp-hr).<sup>284</sup> The results were even higher when we analyzed the data to consider only NO<sub>x</sub> emissions that occur during low load events.

EPA and others have compared the performance of US-certified engines and those certified to European Union emission standards and concluded that the European engines’ NO<sub>x</sub> emissions are lower in low-load conditions, but comparable to US-certified engines subject to MY 2010 standards under city and highway operation.<sup>285</sup> This suggests that manufacturers are responding to the European certification standards by designing their emission controls to perform well under low-load operations, as well as highway operations.

The European Union “Euro VI” emission standards for heavy-duty engines require manufacturers to check for “in-service conformity” by operating their engines over a mix of urban, rural, and motorway driving on prescribed routes using portable emission measurement system (PEMS) equipment to measure emissions.<sup>286 287</sup> Compliance is determined using a work-based windows approach where emissions data are evaluated over segments or “windows.” A window consists of consecutive 1 Hz data points that are summed until the engine performs an amount of work equivalent to the

European transient engine test cycle (World Harmonized Transient Cycle).

EPA is finalizing new off-cycle test procedures similar to the European Euro VI in-service conformity program, with key distinctions that build upon the Euro VI approach, as discussed in the following section. This new approach will require manufacturers to account for a relatively larger proportion of engine operation and thereby further ensure that real-world emissions meet the off-cycle standards.

## 2. Off-Cycle Standards and Test Procedures

We are replacing the NTE test procedures and standards (for NO<sub>x</sub>, PM, HC and CO) for model year 2027 and later engines. Under the final new off-cycle standards and test procedures, engine operation and emissions test data must be assessed in test intervals that consist of 300-second moving average windows (MAWs) of continuous engine operation. Our evaluation accounts for our current understanding that shorter windows are more sensitive to measurement variability and longer windows make it difficult to distinguish between duty cycles. In contrast to the current NTE approach that divides engine operation into two categories (in the NTE zone and out of the NTE zone), this approach will divide engine operation into two categories (or “bins”) based on the time-weighted average engine power of each MAW of engine data, with some limited exclusions from the two bins, as described in more detail in the following discussion.

In the NPRM, we requested comment on the proposed off-cycle standards and test procedures, including the 300 second length of the window. We first note that commenters broadly agree that the current NTE methodology should be revised, and that a MAW structure is preferable for off-cycle standards. Some commenters were concerned that individual seconds of data would be “smeared,” with the same 1-Hz data appearing in both bins as the 300 second windows are placed in the appropriate bin. We are finalizing the window length that we proposed, as the 300 second length provides an adequate averaging time to smooth any anomalous emission events and we anticipate that the final bin structure described in Section III.C.2.i. should also help address these concerns. See Response to Comments Section 11.1 through 11.3 for further details on these comments and EPA’s response to these comments.

Although this program has similarities to the European Euro VI approach, we are not limiting our off-

<sup>279</sup> Specifically, engine operations are excluded if they fall below 30 percent of maximum torque, 30 percent of maximum power, or 15 percent of the European Stationary Cycle speed.

<sup>280</sup> Hamady, Fakhri, Duncan, Alan. “A Comprehensive Study of Manufacturers In-Use Testing Data Collected from Heavy-Duty Diesel Engines Using Portable Emissions Measurement System (PEMS)”. 29th CRC Real World Emissions Workshop, March 10–13, 2019.

<sup>281</sup> Sandhu, Gurdas, et al. “Identifying Areas of High NO<sub>x</sub> Operation in Heavy-Duty Vehicles”. 28th CRC Real-World Emissions Workshop, March 18–21, 2018.

<sup>282</sup> Sandhu, Gurdas, et al. “In-Use Emission Rates for MY 2010+ Heavy-Duty Diesel Vehicles”. 27th CRC Real-World Emissions Workshop, March 26–29, 2017.

<sup>283</sup> Sandhu, Gurdas, et al. “Identifying Areas of High NO<sub>x</sub> Operation in Heavy-Duty Vehicles”. 28th CRC Real-World Emissions Workshop, March 18–21, 2018.

<sup>284</sup> Hamady, Fakhri, Duncan, Alan. “A Comprehensive Study of Manufacturers In-Use Testing Data Collected from Heavy-Duty Diesel Engines Using Portable Emissions Measurement System (PEMS)”. 29th CRC Real World Emissions Workshop, March 10–13, 2019.

<sup>285</sup> Rodriguez, F.; Posada, F. “Future Heavy-Duty Emission Standards An Opportunity for International Harmonization”. The International Council on Clean Transportation. November 2019. Available online: [https://theicct.org/sites/default/files/publications/Future%20\\_HDV\\_standards\\_opportunity\\_20191125.pdf](https://theicct.org/sites/default/files/publications/Future%20_HDV_standards_opportunity_20191125.pdf).

<sup>286</sup> COMMISSION REGULATION (EU) No 582/2011, May 25, 2011. Available online: <https://eur-lex.europa.eu/legal-content/EN/TXT/PDF/?uri=CELEX:02011R0582-20180118&from=EN>.

<sup>287</sup> COMMISSION REGULATION (EU) 2018/932, June 29, 2018. Available online: <https://eur-lex.europa.eu/legal-content/EN/TXT/PDF/?uri=CELEX:32018R0932&from=EN>.

cycle standards and test procedures to operation on prescribed routes. Our current NTE program is not limited to prescribed routes, and we would consider it an unnecessary step backward to change that aspect of the procedure.

In Section IV.G, we discuss the final rule updates to the ABT program to account for these new off-cycle standards.

#### i. Moving Average Window Operation Bins

The final bin structure includes two bins of operation that represent two different domains of emission performance. Bin 1 represents extended idle operation and other very low load operation where engine exhaust temperatures may drop below the optimal temperature for aftertreatment function. Bin 2 represents higher power operation including much of the operation currently covered by the NTE. Operation in bin 2 naturally involves higher exhaust temperatures and catalyst efficiencies. Because this approach divides 300 second windows into bins based on time-averaged engine power of the window, any of the bins could include some idle or high-power operation. Like the duty cycle standards, we believe more than a single standard is needed to apply to the entire range of operation that heavy-duty engines experience. A numerical standard that is technologically feasible under worst case conditions such as idle would necessarily be much higher than the levels that are achievable when the aftertreatment is functioning optimally. Section III.C.2.iii includes the final numeric off-cycle standards.

Given the challenges of measuring engine power directly in-use, we are using the CO<sub>2</sub> emission rate (grams per second) as a surrogate for engine power in defining the bins for an engine. We are further normalizing CO<sub>2</sub> emission rates relative to the nominal maximum CO<sub>2</sub> rate of the engine. So, if an engine with a maximum CO<sub>2</sub> emission rate of 50 g/sec was found to be emitting CO<sub>2</sub> at a rate of 10 g/sec, its normalized CO<sub>2</sub> emission rate would be 20 percent. The maximum CO<sub>2</sub> rate is defined as the engine's rated maximum power multiplied by the engine's CO<sub>2</sub> family certification level (FCL) for the FTP certification cycle.

In the proposal, we requested comment on whether the maximum CO<sub>2</sub> mass emission rate should instead be determined from the steady-state fuel mapping procedure in 40 CFR 1036.535 or the torque mapping procedure defined in 40 CFR 1065.510. After considering comments, EPA is finalizing

the use of the CO<sub>2</sub> emission rate as a surrogate for engine power with the proposed approach to determining the maximum CO<sub>2</sub> mass emission rate. We have two main reasons for finalizing the determination of maximum CO<sub>2</sub> mass emission rate as proposed. First, the FTP FCL and maximum engine power are already reported to the EPA, so no new requirements are needed under the finalized approach. Second, our assessment of the finalized approach has shown that this approach for the determination of maximum CO<sub>2</sub> mass emission rate matches well with the other options we requested comment on. EPA believes that using the CO<sub>2</sub> emission rate will automatically account for additional fuel usage not directly used for driveshaft torque and minimizes concerns about the accuracy and data alignment in the use of broadcast torque. EPA acknowledges that there is some small variation in efficiency, and thus CO<sub>2</sub> emissions rates, among engines. However, the test procedure accounts for improvements to the engine efficiency by using the FTP FCL to convert CO<sub>2</sub> specific NO<sub>x</sub> to work specific NO<sub>x</sub>. This is because the FTP FCL captures the efficiency of the engine over a wide range of operation, from cold start, idle and steady-state higher power operation. Furthermore, the FTP FCL can also capture the CO<sub>2</sub> improvements from hybrid technology when the powertrain test option described in preamble Section III.B.2.v is utilized.

The bins are defined as follows:

- *Bin 1*: 300 second windows with normalized average CO<sub>2</sub> rate ≤6 percent.
- *Bin 2*: 300 second windows with normalized average CO<sub>2</sub> rate >6 percent.

The bin cut point of six percent is near the average power of the low-load cycle. In the NPRM, we proposed a three-bin structure and requested comment on the proposed number of bins and the value of the cut point(s). After considering comments, EPA agrees with commenters to the extent the commenters recommend combining the proposed bins 2 and 3 into a single "non-idle" bin 2. Results from the EPA Stage 3 real world testing indicate that emissions in bins 2 and 3 (expressed as emissions/normalized CO<sub>2</sub>) are substantially similar, minimizing the advantage of separating these modes of operation. See Response to Comments Section 11.1 for further details on these comments and EPA's response to these comments.

To ensure that there is adequate data in each of the bins to compare to the off-cycle standards, the final requirements specify that there must be a minimum of 2,400 moving average windows in bin

1 and 10,000 moving average windows in bin 2. In the NPRM, we proposed a minimum of 2,400 windows for all bins and requested comment on the appropriate minimum number of windows required to sufficiently reduce variability in the results while not requiring an unnecessary number of shift days to be tested to meet the requirement. EPA received comments both supporting the proposed 2,400 window minimum and supporting an increase to 10,000 windows total for the non-idle bins (now a single bin 2 in this final rule). After considering comments, we believe requiring a minimum of 10,000 windows in final bin 2 to define a valid test is appropriate. Analysis of data from the EPA Stage 3 off-cycle test data has shown that emissions are stable after 6,000 windows of data at moderate temperatures but NO<sub>x</sub> emissions under low ambient temperatures need closer to 10,000 windows to be stable. EPA believes the larger number of required windows will better characterize the emissions performance of the engine.

If during the first shift day any of the bins do not include at least the minimum number of windows, then the engine will need to be tested for additional day(s) until the minimum requirement is met. Additionally, the engine can be idled at the end of the shift day to meet the minimum window count requirement for the idle bin. This is to ensure that even for duty cycles that do not include significant idle operation the minimum window count requirement for the idle bin can be met without testing additional days.

We received comments on the timing and duration of the optional end-of-day idle. After considering comments, the final requirements specify that the ability to add idle time is restricted to the end of the shift day, and manufacturers may extend this end-of-day idle period to be as long as they choose. Additional idle in the middle of the shift day is contrary to the intent of real-world testing, and the end of the shift day is the only realistic time to add windows. Since idle times of varying lengths are encountered in real-world operation, we do not think that requiring a specific length of idle time would necessarily make the resulting data set more representative.

As described further in section III.C.2.ii, after consideration of comment, EPA is including requirements in 40 CFR 1036.420 that specify that during the end-of-day idle period, when testing vehicles with automated engine shutdown features, manufacturers will be required to override the automated shutdown feature where possible. This will ensure

that the test data will contain at least 2,400 windows in the idle bin, which otherwise would be unobtainable. For automated shutdown features that cannot be overridden, the manufacturer may populate the bin with zero emission values for idle until exactly 2,400 windows are achieved.

ii. Off-Cycle Test Procedures

The final off-cycle test procedures include measuring off-cycle emissions using the existing test procedures that specify measurement equipment and the process of measuring emissions during testing in 40 CFR part 1065. Part 1036, subpart E contains the process for recruiting test vehicles, how to test over the shift day, how to evaluate the data, what constitutes a valid test, and how to determine if an engine family passes. Measurements may use either the general laboratory test procedures or the field-testing procedures in 40 CFR part

1065, subpart J. However, we are finalizing special calculations for bin 2 in 40 CFR 1036.530 that will supersede the brake-specific emission calculations in 40 CFR part 1065. The test procedures require second-by-second measurement of the following parameters:

- Molar concentration of CO<sub>2</sub> (ppm)
- Molar concentration of NO<sub>x</sub> (ppm)
- Molar concentration of HC (ppm)
- Molar concentration of CO (ppm)
- Concentration of PM (g/m<sup>3</sup>)
- Exhaust flow rate (m<sup>3</sup>/s)

Mass emissions of CO<sub>2</sub> and each regulated pollutant are separately determined for each 300-second window and are binned based on the normalized CO<sub>2</sub> rate for each window.

Additionally, EPA agrees with commenters that the maximum allowable engine coolant temperature at the start of the day should be raised to 40 degrees Celsius and we are finalizing

this change in 40 CFR 1036.530. In the NPRM, we proposed 30 °C which is 86 °F. It is possible that ambient temperatures in some regions of the United States won't drop below this overnight. We are therefore finalizing 40 °C which is 104 °F as this should ensure that high overnight ambient temperatures do not prevent a manufacturer from testing a vehicle.

The standards described in Section III.C.2.iii are expressed in units of g/hr for bin 1 and mg/hp-hr for bin 2.

However, unlike most of our exhaust standards, the hp-hr values for the off-cycle standards do not refer to actual brake work. Rather, they refer to nominal equivalent work calculated proportional to the CO<sub>2</sub> emission rate. Thus, in 40 CFR 1036.530 the NO<sub>x</sub> emissions ("e") in g/hp-hr are calculated as:

$$e \left( \frac{\text{mg}}{\text{hp} \cdot \text{hr}} \right) = \frac{\text{Sum of Window NO}_x \text{ mass per Bin}}{\text{Sum of Window CO}_2 \text{ mass per Bin}} \cdot \frac{\text{FTP CO}_2 \text{ mass}}{\text{FTP work}}$$

The final requirements include a limited number of exclusions (six total) in 40 CFR 1036.530(c)(3) that exclude some data from being subject to the off-cycle standards. The first exclusion in 40 CFR 1036.530(c)(3)(i) is for data collected during periodic PEMS zero and span drift checks or calibrations, where the emission analyzers and/or flow meter are not available to measure emissions during that time and these checks/calibrations are needed to ensure the robustness of the data.

The second exclusion in 40 CFR 1036.530(c)(3)(ii) is for data collected anytime the engine is off during the course of the shift day, with modifications from proposal that (1) this exclusion does not include engine off due to automated stop-start, and (2) specific requirements for vehicles with stop-start technology. In the NPRM, we proposed excluding data for vehicles with stop-start technology when the engine was off and requested comment on the appropriateness of this exclusion. We received comment suggesting provisions for vehicles equipped with automated stop-start technology. After considering comments, EPA has included in the final rule requirements applicable when testing vehicles with automatic engine shutdown (AES) and/or stop-start technology. Under the final requirements, the manufacturer shall disable AES and/or stop-start if it is not tamper resistant as described in 40 CFR 1036.415(g), 1036.420(c), and

1036.530(c)(3). If stop-start is tamper resistant, the 1-Hz emission rate for all GHG and criteria pollutants shall be set to zero when AES and/or stop-start is active and the engine is off, and these data are included in the normal windowing process (*i.e.*, the engine-off data are not treated as exclusions). If at the end of the shift day there are not 2,400 windows in bin 1 for a vehicle with AES and/or stop-start technology, the manufacturer must populate the bin with additional windows with the emission rate for each GHG and criteria pollutant set to zero to achieve exactly 2,400 idle bin windows. This process accounts for manufacturers who implement a start/stop mode that cannot be overridden and applies the windowing and binning process in a way that is similar to the process applied to a conventionally idling vehicle.

The third exclusion in 40 CFR 1036.530(c)(3)(iii) is for data collected during infrequent regeneration events. The data collected for the test order may not collect enough operation to properly weight the emissions rates during an infrequent regeneration event with emissions that occur without an infrequent regeneration event.

The fourth exclusion in 40 CFR 1036.530(c)(3)(iv) is for data collected when ambient temperatures are below 5 °C (this aspect includes some modifications from proposal), or when ambient temperatures are above the

altitude-based value determined using Equation 40 CFR 1036.530-1. The colder temperatures can significantly inhibit the engine's ability to maintain aftertreatment temperature above the minimum operating temperature of the SCR catalyst while the higher temperature conditions at altitude can limit the mass airflow through the engine, which can adversely affect the engine's ability to reduce engine out NO<sub>x</sub> through the use of exhaust gas recirculation (EGR). In addition to affecting EGR, the air-fuel ratio of the engine can decrease under high load, which can increase exhaust temperatures above the conditions where the SCR catalyst is most efficient at reducing NO<sub>x</sub>. However, we also do not want to select temperature limits that overly exclude operation, such as setting a cold temperature limit so high that it excludes important initial cold start operation from all tests, or a number of return to service events. These are important operational regimes, and the MAW protocol is intended to capture emissions over the entire operation of the vehicle. The final rule strikes an appropriate balance between these considerations.

In the NPRM, we proposed excluding data when ambient temperatures were below -7 °C and requested comment on the appropriateness of this exclusion. Several comments disagreed with the proposed low temperature exclusion level and recommended a higher

temperature of 20 °C as well as additional exemptions for coolant and oil temperatures, and recommended low temperature exclusion temperatures that ranged from 20 to 70 °C. After considering comments, we adjusted the final ambient temperature exclusion to 5 °C. We have additionally incorporated a temperature-based adjustment to the final numerical NO<sub>x</sub> standards, as described in Section III.C.iii. However, we have not incorporated exclusions based on coolant and oil temperatures. These changes are supported by data recently generated from testing at SwRI with the EPA Stage 3 engine at low temperatures over the CARB Southern Route Cycle and Low Load Cycle. This testing consisted of operation of the engine over the duty-cycle with the test cell ambient temperature set at 5 °C with air flow moving over the aftertreatment system to simulate the airflow over the aftertreatment during over the road operation. The results indicated that there were cold ambient air temperature effects on aftertreatment temperature that reduced NO<sub>x</sub> reduction efficiency, which supports that the temperature should be increased. With these changes, our analysis, as described in section III.C, shows that the off-cycle standards are achievable for MY 2027 and later engines down to 5 °C, taking into account the temperature-based adjustment to the final numerical standards. We have concerns about whether the off-cycle standards could be met below 5 °C after taking a closer look at all data regarding real world effects and based on this we are exempting data from operation below 5 °C from being subject to the standards.

The fifth exclusion in 40 CFR 1036.530(c)(3)(v) is for data collected where the altitude is greater than 5,500 feet above sea level for the same reasons as for the high temperatures at altitude exclusion.

The sixth exclusion in 40 CFR 1036.530(c)(3)(vi) is for data collected

when any approved Auxiliary Emission Control Device (AECD) for emergency vehicles are active because the engines are allowed to exceed the emission standards while these AECs are active.

To reduce the influence of environmental conditions on the accuracy and precision of the PEMS for off-cycle in-use testing, we are adding additional changes to those proposed in requirements in 40 CFR 1065.910(b). These requirements are to minimize the influence of temperature, electromagnetic frequency, shock, and vibration on the emissions measurement. If the design of the PEMS or the installation of the PEMS does not minimize the influence of these environmental conditions, the final requirements specify that the PEMS must be installed in an environmental chamber during the off-cycle test to minimize these effects.

iii. Off-Cycle Standards

For NO<sub>x</sub>, we are finalizing separate standards for distinct modes of operation. To ensure that the duty-cycle NO<sub>x</sub> standards and the off-cycle NO<sub>x</sub> standards are set at the same relative stringency level, the bin 1 standard is proportional to the Voluntary Idle standard discussed in Section III.B.2.iv, and the bin 2 standard is proportional to a weighted combination of the LLC standard discussed in Section III.B.2.iii and the SET standard discussed in Section III.B.2.ii. For bin 1, the NO<sub>x</sub> emission standard for all CI primary intended service classes is 10.0 g/hr starting in model year 2027. For PM, HC and CO we are not setting standards for bin 1 because the emissions from these pollutants are very small under idle conditions and idle operation is extensively covered by the SET, FTP, and LLC duty cycles discussed in Section III.B.2. The combined NO<sub>x</sub> bin 2 standard is weighted at 25 percent of the LLC standard and 75 percent of the SET standard, reflecting the nominal

flow difference between the two cycles. For HC, the bin 2 standard is also set at values proportional to a 25 percent/75 percent weighted combination of the LLC standard and the SET standard.<sup>288</sup> For PM and CO, the SET, FTP, and LLC standards are the same numeric value, so bin 2 is proportional to that numeric standard. The numerical values of the off-cycle standards for bin 2 are shown in Table III–17.

The final numerical off-cycle bin 1 NO<sub>x</sub> standard reflect a conformity factor of 1.0 times the Clean Idle standard discussed in Section III.B.2.iv. The final numerical off-cycle bin 2 standards for all pollutants reflect a conformity factor of 1.5 times the duty-cycle standards set for the LLC and SET cycles discussed in Section III.B.2.ii and Section III.B.2.iii. Additionally, as discussed in Section III.B.2, the in-use NO<sub>x</sub> off-cycle standard for Medium and Heavy HDE reflects an additional 15 mg/hp-hr NO<sub>x</sub> allowance above the bin 2 standard. Similar to the duty cycle standards, the off-cycle standards were set at a level that resulted in at least 40 percent compliance margin for the EPA Stage 3 engine. We requested and received comments on the appropriate scaling factors or other approaches to setting off-cycle standards. After consideration of the comments, we believe the final numerical standards are feasible and appropriate for certification and in-use testing. We note that the final standards are similar, but not identical to, the options proposed in the NPRM. As with the duty cycle standards discussed in Preamble Section III.B, the data from the EPA Stage 3 engine supported the most stringent numeric standards we proposed under low-load operation and the most stringent numeric standards we proposed for MY 2027 under high load operation. More discussion of the feasibility of these standards can be found in the following discussion and in Section III.C.3 and Response to Comments Section 11.3.1.

TABLE III–17—OFF-CYCLE BIN 2 STANDARDS

	NO <sub>x</sub> (mg/hp-hr)	HC (mg/hp-hr)	PM (mg/hp-hr)	CO (g/hp-hr)
58 <sup>a</sup> .....		120	7.5	9

<sup>a</sup> An interim NO<sub>x</sub> compliance allowance of 15 mg/hp-hr applies for any in-use testing of Medium HDE and Heavy HDE. Manufacturers will add the compliance allowance to the NO<sub>x</sub> standard that applies for each duty cycle and for off-cycle Bin 2, for both in-use field testing and laboratory testing as described in 40 CFR 1036, subpart E. Note, the NO<sub>x</sub> compliance allowance doesn't apply to confirmatory testing described in 40 CFR 1036.235(c) or selective enforcement audits described in 40 CFR part 1068.

In the proposal, we requested comment on the in-use test conditions

over which engines should be required to comply with the standard, asking

commentors to take into consideration any tradeoffs that broader or narrower

<sup>288</sup> See Preamble Section III.B.2 for the HC standards for the SET and LLC.

conditions might have on the stringency of the standard we set. After considering comments on low ambient air temperature and the available data from the low-temperature Stage 3 testing at SwRI described in section III.C.2.ii, we are also incorporating an adjustment to the numerical off-cycle bin 1 and bin 2 standards for NO<sub>x</sub> as a function of ambient air temperature below 25 °C. The results demonstrated higher NO<sub>x</sub> emissions at low temperatures, indicating that standards should be numerically higher to account for real-

world temperature effects on the aftertreatment system. To determine the magnitude of this adjustment, we calculated the increase in the Stage 3 engine NO<sub>x</sub> emissions over the CARB Southern Route Cycle at low temperature over the NO<sub>x</sub> emissions at 25 °C. These values were linearly extrapolated to determine the projected increase at 5 °C versus 25 °C. Table III–18 presents the numerical value of each off-cycle bin 1 and bin 2 NO<sub>x</sub> standard at both 25 °C and 5 °C.

Under the final requirements in 40 CFR 1036.104, the ambient temperature

adjustment is applied based on the average 1-Hz ambient air temperature during the shift day for all data not excluded under 40 CFR 1036.530(c), calculated as the time-averaged temperature of all included data points. If this average temperature is 25 °C or above, no adjustment to the standard is made. If the average temperature is below 25 °C, the applicable NO<sub>x</sub> standard is calculated using the equations in Table 3 to paragraph (a)(3) of 40 CFR 1036.104 Table III–18 for the appropriate service class and bin.

TABLE III–18—TEMPERATURE ADJUSTMENTS TO THE OFF-CYCLE NO<sub>x</sub> STANDARDS

Service class	Applicability	Bin	NO <sub>x</sub> standard at 25 °C	NO <sub>x</sub> standard at 5 °C	Applicable unit
All .....	All .....	1	10	<sup>a</sup> 15	g/hr.
Light HDE .....	Certification & In-use .....	2	58	<sup>a</sup> 102	mg/hp-hr.
Medium and Heavy HDE .....	Certification .....	2	58	<sup>a</sup> 102	mg/hp-hr.
Medium and Heavy HDE .....	In-Use .....	2	<sup>a</sup> 73	<sup>a</sup> 117	mg/hp-hr.

<sup>a</sup> The Bin 1 and Bin 2 ambient temperature adjustment and the NO<sub>x</sub> compliance allowance for in-use testing do not scale with the FEL<sub>FTPNO<sub>x</sub></sub>.

3. Feasibility of the Diesel (Compression-Ignition) Off-Cycle Standards

i. Technologies

As a starting point for our determination of the appropriate numeric levels of the off-cycle emission standards, we considered whether manufacturers could meet the duty-cycle standard corresponding to the type of engine operation included in a given bin,<sup>289</sup> as follows:

- Bin 1 operation is generally similar to operation at idle and the lower speed portions of the LLC.
- Bin 2 operation is generally similar to operation over the LLC, the FTP and much of the SET.

An important question is whether the off-cycle standards would require technology beyond what we are projecting would be necessary to meet the duty-cycle standards. As described in this section, we do not expect the off-cycle standards to require different technologies.

This is not to say that we expect manufacturers to be able to meet these standards with no additional work. Rather, we project that the off-cycle standards can be met primarily through additional effort to calibrate the duty-cycle technologies to function properly over the broader range of in-use conditions. We also recognize that manufacturers can choose to include

additional technology, if it provided a less expensive or otherwise preferred option.

When we evaluated the technologies discussed in Section III.B.3.i with emissions controls that were designed to cover a broad range of operation, it was clear that we should set the off-cycle standards to higher numerical values than the duty-cycle standards to take into account the broader operations covered by the off-cycle test procedures. Section III.C.3.ii explains how the technology and controls performed when testing with the off-cycle test procedures over a broad range of operation. The data presented in Section III.C.3.ii shows that even though there are similarities in the operation between the duty cycles (SET, FTP, and LLC) and the off-cycle bins 1 and 2, the broader range of operation covered by the off-cycle test procedure results in a broader range of emissions performance, which justifies setting the numeric off-cycle standards higher than the corresponding duty cycle standards for equivalent stringency. In addition to this, the off-cycle test procedures and standards cover a broader range of ambient temperature and pressure, which can also increase the emissions from the engine as discussed in Section III.C.2.ii.

ii. Summary of Feasibility Analysis

To identify appropriate numerical levels for the off-cycle standards, we evaluated the performance of the EPA Stage 3 engine in the laboratory on five different cycles that were created from field data of HD engines that cover a

range of off-cycle operation. These cycles are the CARB Southern Route Cycle, Grocery Delivery Truck Cycle, Drayage Truck Cycle, Euro-VI ISC Cycle (EU ISC) and the Advanced Collaborative Emissions Study (ACES) cycle. The CARB Southern Route Cycle is predominantly highway operation with elevation changes resulting in extended motoring sections followed by high power operation. The Grocery Delivery Truck Cycle represents goods delivery from regional warehouses to downtown and suburban supermarkets and extended engine-off events characteristic of unloading events at supermarkets. Drayage Truck Cycle includes near dock and local operation of drayage trucks, with extended idle and creep operation. Euro-VI ISC Cycle is modeled after Euro VI ISC route requirements with a mix of 30 percent urban, 25 percent rural and 45 percent highway operation. ACES Cycle is a 5-mode cycle developed as part of ACES program. Chapter 3 of the RIA includes figures that show the engine speed, engine torque and vehicle speed of the cycles.

The engine was initially calibrated to minimize NO<sub>x</sub> emissions for the dynamometer duty cycles (SET, FTP, and LLC). It was then further calibrated to achieve more optimal performance over off-cycle operation. The test results shown in Table III–19 provide a reasonable basis for evaluating the feasibility of controlling off-cycle emissions to a useful life of 435,000 miles and 800,000 miles. Additionally,

<sup>289</sup> See preamble Section III.B.3 for details on EPA's assessment of the feasibility of the duty-cycle standards.

the engine tested did not include the SCR catalyst volume that is included in our cost analysis and that we determined should enable lower bin 2 NO<sub>x</sub> emissions, further supporting that the final standards are feasible. Additionally, the 800,000 mile aged aftertreatment was tested over the CARB

Southern Route Cycle with an ambient temperature between 2 °C and 9 °C (6.8 °C average), the average of which is slightly above the 5 °C minimum ambient temperature that the final requirements specify as the level below which test data are excluded.<sup>290</sup> The summary of the results is in Chapter 3

of the RIA. For Light HDE standards, we looked at the data at the equivalent of 435,000 miles.<sup>291</sup> For the Medium and Heavy HDE standards we looked at the data at the equivalent of 800,000 miles.<sup>292</sup>

TABLE III–19—EPA STAGE 3 NO<sub>x</sub> EMISSIONS OFF-CYCLE OPERATION WITHOUT ADJUSTMENTS FOR CRANKCASE EMISSIONS

Equivalent miles, ambient T (°C)	Bin No.	CARB southern route cycle	Grocery deliv. cycle	ACES	EU ISC	Drayage
435,000, 25 °C .....	1 (g/hr) .....	0.7	1.0	0.9	0.4	0.3
	2 (mg/hp-hr) .....	32	21	20	31	19
800,000, 25 °C .....	1 (g/hr) .....	0.7	3.3	1.5	0.4	1.1
	2 (mg/hp-hr) .....	47	32	34	32	28
800,000, 2 to 9 °C .....	1 (g/hr) .....	1.4	Not tested			
	2 (mg/hp-hr) .....	87	Not tested			

a. Bin 1 Evaluation

Bin 1 includes the idle operation and some of the lower speed operation that occurs during the FTP and LLC. However, it also includes other types of low-load operation observed with in-use vehicles, such as operation involving longer idle times than occur in the LLC. To ensure that the bin 1 standard is feasible, we set the idle bin standard at the level projected to be achievable engine-out with exhaust temperatures below the aftertreatment light-off temperature. As can be seen from the results in Table III–19, the EPA Stage 3 engine performed well below the bin 1 NO<sub>x</sub> standards. The summary of the results is located in Chapter 3 of the RIA.

For bin 1 we are finalizing NO<sub>x</sub> standard at a level above what we have demonstrated because there are conditions in the real world that may prevent the emissions control technology from being as effective as demonstrated with the EPA Stage 3 engine. For example, under extended idle operation the EGR rate may need to be reduced to maintain engine durability. Under extended idle operation with cold ambient temperatures, the aftertreatment system can lose NO<sub>x</sub> reduction efficiency

which can also increase NO<sub>x</sub> emissions. Taking this under consideration, as well as other factors, we believe that the final bin 1 NO<sub>x</sub> standard in Table III–17 is the lowest achievable standard in MY 2027.

b. Bin 2 Evaluations

As can be seen see from the results in Table III–19, the NO<sub>x</sub> emissions from the Stage 3 engine in bin 2 were below the final off-cycle standards for each of the off-cycle duty-cycles. The HC and CO emissions measured for each of these off-cycle duty cycles were well below the final off-cycle standards for bin 2. PM emissions were not measured during the off-cycle tests, but based on the effectiveness of DPFs over all engine operation as seen with the SET, FTP, and LLC, our assessment is that the final PM standards in Bin 2 are feasible. The summary of the results is located in Chapter 3 of the RIA.

For bin 2, all the 25 °C off-cycle duty cycles at a full useful life of 800,000 miles had emission results below the NO<sub>x</sub> certification standard of 58 mg/hp-hr shown in Table III–19. Additionally, the CARB Southern Route Cycle run at ambient temperatures under 10 °C had emission results below the Heavy HDE NO<sub>x</sub> in-use off-cycle standard of 106 mg/hp-hr which is the standard at 10 °C

as determined from Equation 40 CFR 1036.104–2. While this cycle was run at temperatures above the minimum ambient temperature exclusion limit of 5 °C that we are finalizing, we expect actual HDIUT testing to be less severe than the demonstration. Nonetheless, since the results of the low ambient temperature testing demonstrated higher NO<sub>x</sub> emissions at low temperatures, as shown in Table III–19, we have finalized standards that are numerically higher at lower temperatures to account for real-world temperature effects on the aftertreatment system.

In the NPRM, we requested comment on the numerical values of the off-cycle standards, as well as the overall structure of the off-cycle program. We received comments recommending both lower and higher numerical standards than were proposed. After considering the comments, we believe the off-cycle standards that we are finalizing are appropriate and feasible values. See Response to Comments Section 11.3.1 for further details on these comments and EPA’s response to these comments.

4. Compliance and Flexibilities for Off-Cycle Standards

Given the similarities of the off-cycle standards and test procedures to the current NTE requirements that we are

<sup>290</sup> The low ambient temperature exclusion was raised from the proposed level of –7 °C to 5 °C, since engines can continue to use EGR to reduce NO<sub>x</sub> without the use of an EGR cooler bypass at and above 5 °C. See RIA Chapter 3.1.1.2.2 for a summary of data from the EPA Stage 3 engine with three different idle calibrations.

<sup>291</sup> See Section III.B.3.ii for an explanation on why we determined data at the equivalent of 435,000 miles was appropriate for determining the feasibility of the Light HDE standards.

<sup>292</sup> Similar to our reasoning in Section III.B.3.ii for using the interpolated data at the equivalent of 650,000 miles to determine the feasibility of the duty cycle standards for Medium and Heavy HDE, we determined the data at the equivalent of 800,000 was appropriate for determining the feasibility of the Medium and Heavy HDE off-cycle standards. The one difference is that emission data was not collected at the equivalent of 600,000 miles. Therefore, we used the data at the equivalent of 800,000 miles (rather than assuming the emissions performance changed linearly and interpolating the

emissions from the data at the equivalent of 435,000 and 800,000 miles) to determine the emissions performance at the equivalent of 650,000 miles. We think it’s appropriate to use the data at the equivalent of 800,000 miles (rather than the interpolated data at the equivalent of 650,000 miles) to account for uncertainties in real world performance, particularly given the significant increases in useful life, decreases in the numeric levels of the standards, and the advanced nature of the technologies.

replacing starting in MY 2027, we evaluated the appropriateness of applying the current NTE compliance provisions to the off-cycle standards we are finalizing and determined which final compliance requirements and flexibilities are applicable to the new final off-cycle standards, as discussed immediately below.

#### i. Relation of Off-Cycle Standards To Defeat Devices

CAA section 203 prohibits bypassing or rendering inoperative a certified engine's emission controls. When the engine is designed or modified to do this, the engine is said to have a defeat device. With today's engines, the greatest risks with respect to defeat devices involve manipulation of the engine's electronic controls. EPA refers to an element of design that manipulates emission controls as an Auxiliary Emission Control Device (AECD).<sup>293</sup> Unless explicitly permitted by EPA, AECDs that reduce the effectiveness of emission control systems under conditions which may reasonably be expected to be encountered in normal vehicle operation and use are prohibited as defeat devices under current 40 CFR 86.004–2.

For certification, EPA requires manufacturers to identify and describe all AECDs.<sup>294</sup> For any AECD that reduces the effectiveness of the emission control system under conditions which may reasonably be expected to be encountered in normal vehicle operation and use, manufacturers must provide a detailed justification.<sup>295</sup> We are migrating the definition of defeat device from 40 CFR 86.004–2 to 40 CFR 1036.115(h) and clarifying that an AECD is not a defeat device if such conditions are substantially included in the applicable procedure for duty-cycle testing as described in 40 CFR 1036, subpart F. Such AECDs are not treated as defeat devices because the manufacturer shows that their engines are able to meet standards during duty-cycle testing while the AECD is active. The AECD might reduce the effectiveness of emission controls, but not so much that the engine fails to meet the standards that apply.

We do not extend this same treatment to off-cycle testing, for two related

reasons. First, we can have no assurance that the AECD is adequately exercised during any off-cycle operation to support the conclusion that the engine will consistently meet emission standards over all off-cycle operation. Second, off-cycle testing may involve operation over an infinite combination of engine speeds and loads, so excluding AECDs from consideration as defeat devices during off-cycle testing would make it practically impossible to conclude that an engine has a defeat device.

If an engine meets duty-cycle standards and the engine has no defeat devices, we should be able to expect engines to achieve a comparable level of emission control for engine operation that is different than what is represented by the certification duty cycles. The off-cycle standards and measurement procedures allow for a modest increase in emissions for operation that is different than the duty cycle, but manufacturers may not change emission controls to increase emissions to the off-cycle standard if those controls were needed to meet the duty-cycle standards. The finalized off-cycle standards are set at a level that is feasible under all operating conditions, so we expect that under much of the engine operation the emissions are well below the final off-cycle standards.

#### ii. Heavy-Duty In-Use Testing Program

Under the current manufacturer-run heavy-duty in-use testing (HDIUT) program, EPA annually selects engine families to evaluate whether engines are meeting current emissions standards. Once we submit a test order to the manufacturer to initiate testing, it must contact customers to recruit vehicles that use an engine from the selected engine family. The manufacturer generally selects five unique vehicles that have a good maintenance history, no malfunction indicators on, and are within the engine's regulatory useful life for the requested engine family. The tests require use of portable emissions measurement systems (PEMS) that meet the requirements of 40 CFR part 1065, subpart J. Manufacturers collect data from the selected vehicles over the course of a day while they are used for their normal work and operated by a regular driver, and then submit the data to EPA. Compliance is currently evaluated with respect to the NTE standards.

With some modifications from proposal, we are continuing the HDIUT program, with compliance with respect to the new off-cycle standards and test procedures added to the program beginning with MY 2027 engines. As

proposed, we are not carrying forward the Phase 2 HDIUT requirements in 40 CFR 86.1915 once the NTE phases out after MY 2026. Under the current NTE based off-cycle test program, if a manufacturer is required to test ten engines under Phase 1 testing and less than eight fully comply with the vehicle pass criteria in 40 CFR 86.1912, we could require the manufacturer to initiate Phase 2 HDIUT testing which would require manufacturers to test an additional 10 engines. After consideration of comments, we are generally finalizing our overall long term HDIUT program's engine testing steps and pass/fail criteria as proposed; however, EPA believes that an interim approach in the initial two years of the program is appropriate, as manufacturers transition to the final standards, test procedures, and requirements, while still providing overall compliance assurance during that transition. More specifically, we are finalizing that compliance with the off-cycle standards would be determined by testing a maximum of fifteen engines for MYs 2027 and MY 2028 under the interim provisions, and ten engines for MYs 2029 and later. As noted in the proposal, the testing of a maximum of ten engines was the original limit under Phase 1 HDIUT testing in 40 CFR 86.1915. Similar to the current Phase 1 HDIUT requirements in 40 CFR 86.1912, the finalized 40 CFR 1036.425 and finalized interim provision in 40 CFR 1036.150(z) require initially testing five engines. Various outcomes are possible based on the observed number of vehicle passes or failures from manufacturer-run in-use testing, as well as other supplemental information. Under the interim provisions for MYs 2027 and 2028, if four of the first test vehicles meet the off-cycle standards, testing stops, and no other action is required of the manufacturer for that diesel engine family. For MYs 2029 and later, if five of the first test vehicles meet the off-cycle standards, testing stops, and no other action is required of the manufacturer for that diesel engine family. For MYs 2027 and 2028, if two of those engines do not comply fully with the off-cycle bin standards, the manufacturer would then test five additional engines for a total of ten. For MYs 2029 and later, if one of those engines does not comply fully with the off-cycle bin standards, the manufacturer would then test a sixth engine. For MYs 2027 and 2028, if eight of the ten engines tested pass, testing stops, and no other action is required of the manufacturer for that diesel engine family under the program for that model

<sup>293</sup> 40 CFR 86.082–2 defines Auxiliary Emission Control Device (AECD) to mean “any element of design which senses temperature, vehicle speed, engine RPM, transmission gear, manifold vacuum, or any other parameter for the purpose of activating, modulating, delaying, or deactivating the operation of any part of the emission control system.”

<sup>294</sup> See 40 CFR 86.094–21(b)(1)(i)(A).

<sup>295</sup> See definition of “defeat device” in 40 CFR 86.004–2.



year. For MYs 2029 and later, if five of the six engines tested pass, testing stops, and no other action is required of the manufacturer for that diesel engine family under the program for that model year. For MYs 2027 and 2028, if three or more of the first ten engines tested do not pass, the manufacturer may test up to five additional engines until a maximum of fifteen engines have been tested. For MYs 2029 and later, when two or more of the first six engines tested do not pass, the manufacturer must test four additional engines until a total of ten engines have been tested. If the arithmetic mean of the emissions from the ten, or up to fifteen under the interim provisions, engine tests determined in § 1036.530(g), or § 1036.150(z) under the interim provisions, is at or below the off-cycle standard for each pollutant, the engine family passes and no other action is required of the manufacturer for that diesel engine family. If the arithmetic mean of the emissions from the ten, or up to fifteen under the interim provisions, engines for either of the two bins for any of the pollutants is above the respective off-cycle bin standard, the engine family fails and the manufacturer must join EPA in follow-up discussions to determine whether any further testing, investigations, data submissions, or other actions may be warranted. Under the final requirements, the manufacturer may accept a fail result for the engine family and discontinue testing at any point in the sequence of testing the specified number of engines.

We received comment on the elimination of Phase 2 testing. See Response to Comment Section 11.5.1 for further information on these comments and EPA's response to these comments. As noted in the preceding paragraphs, we are finalizing elimination of Phase 2 testing. However, we also are clarifying what happens when an engine family fails under the final program. In such a case, three outcomes are possible. First, we may ultimately decide not to take further action if no nonconformity is indicated after a thorough evaluation of the causes or conditions that caused vehicles in the engine family to fail the off-cycle standards, and a review of any other supplemental information obtained separately by EPA or submitted by the manufacturer shows that no significant nonconformity exists. Testing would then stop, and no other action would be required of the manufacturer for that diesel engine family under the program for that year. Second, we may seek some form of remedial action from the manufacturer

based on our evaluation of the test results and review of other supplemental information. Third, and finally, in situations where a significant nonconformity is observed during testing, we may order a recall action for the diesel engine family in question if the manufacturer does not voluntarily initiate an acceptable remedial action.

In the NPRM, we proposed allowing manufacturers to test a minimum of 2 engines using PEMS, in response to a test order program, provided they measure, and report in-use data collected from the engine's on-board NO<sub>x</sub> measurement system. EPA received comments expressing concerns on the feasibility of this alternate in-use testing option. Given meaningful uncertainties in whether technological advancement of measurement capabilities of these sensors will occur by MY 2027, at this time, EPA is not including the proposed option in 40 CFR 1036.405(g) and not finalizing this alternative test program option in this action. The final in-use option for manufacturers to show compliance with the off-cycle standard will require the use of currently available PEMS to measure criteria pollutant emissions, with the sampling and measurement of emission concentrations in a manner similar to the current NTE in-use test program as described in 40 CFR part 1036, subpart E, and Section III.C of this preamble. See Response to Comment Section 11.5.3 for further information on these comments and EPA's response to these comments.

In the NPRM, we proposed to not carry forward the provision in 40 CFR 86.1908(a)(6) that considers an engine misfueled if operated on a biodiesel fuel blend that is either not listed as allowed or otherwise indicated to be an unacceptable fuel in the vehicle's owner or operator manual. We also proposed in 40 CFR 1036.415(c)(1) to allow vehicles to be tested for compliance with the new off-cycle standards on any commercially available biodiesel fuel blend that meets the specifications for ASTM D975 or ASTM D7467.

We received comments on these proposed requirements. After considering the comments, we have altered provisions in the final rule from what was proposed. EPA agrees with the commenters' recommendation to restrict in-use off-cycle standards testing on vehicles that have been fueled with biodiesel to those that are either expressly allowed in the vehicle's owner or operator manual or not otherwise indicated as an unacceptable fuel in the vehicle's owner or operator manual or in the engine manufacturer's published fuel recommendations. EPA

believes, as explained in section IV.H of this preamble, that data show biodiesel is compliant with ASTM D975, D7467 and D6751, that the occurrence of metal contamination in the fuel pool is extremely low, and that the metal content of biodiesel is low. However, EPA understands that manufacturers have little control over the quality of fuel that their engines will encounter over years of in-use operation.<sup>296</sup> To address uncertainties, EPA is modifying the proposed approach to in-use off-cycle standards testing and will allow manufacturers to continue to exempt engines from in-use off-cycle standards testing if the engine is being operated on biofuel that exceeds the manufacturers maximum allowable biodiesel percentage usable in their engines, as specified in the engine owner's manual. See 40 CFR 1036.415(c)(1).

EPA requested comment on a process for a manufacturer to receive EPA approval to exempt test results from in-use off-cycle standards testing from being considered for potential recall if an engine manufacturer can show that the vehicle was historically fueled with biodiesel blends whose B100 blendstock did not meet the ASTM D6751–20a limit for Na, K, Ca, and/or Mg metal (metals which are a byproduct of biodiesel production) or contaminated petroleum based fuels (*i.e.* if the manufacturer can show that the vehicle was misfueled), and the manufacturer can show that misfueling lead to degradation of the emission control system performance. 40 CFR 1068.505 describes how recall requirements apply for engines that have been properly maintained and used. Given the risk of metal contamination from biofuels and in some rare cases petroleum derived fuels, EPA will be willing to engage with any information manufacturers can share to demonstrate that the fueling history caused an engine to be noncompliant based on improper maintenance or use. It is envisioned that this engagement would include submission by the manufacturer of a comparison of the degraded emission control system to a representative compliant system of similar miles with respect to content of the contaminant, including an analysis of the level of the poisoning agents on the catalysts in the engine's aftertreatment system. This

<sup>296</sup> At this time, as explained in the proposed rule, EPA did not propose and is not taking final action to regulate biodiesel blend metal content because the available data does not indicate that there is widespread off-specification biodiesel blend stock or biodiesel blends in the marketplace. EPA also notes that the request to set a maximum nationwide biodiesel percentage of 20 percent is outside the scope of this final rule.

process addresses concerns expressed by a commentator who stated that it would be difficult if not impossible for a manufacturer to provide “proof of source” of the fuel contamination that led to the degradation in catalyst performance. This clarifies that the manufacturer must only determine the amount of poisoning agent present versus a baseline aftertreatment system.

In the NPRM, we requested comment on the need to measure PM emissions during in-use off-cycle testing of engines that comply with MY 2027 or later standards if they are equipped with a DPF. PEMS measurement is more complicated and time-consuming for PM measurements than for gaseous pollutants such as NO<sub>x</sub> and eliminating it for some or all of in-use off-cycle standards testing would provide significant cost savings. We received comments both in support of and in opposition to continuing to require measurement of PM during in-use off-cycle standards testing. After considering these comments, EPA believes that historic test results from the manufacturer run in-use test program indicate that there is not a PM compliance problem for properly maintained engines. Additionally, we believe that removing the requirement for in-use off-cycle PM standards testing will not lead manufacturers to stop using wall flow DPF technology to meet the PM standards. Therefore, EPA is not including the proposed requirement for manufacturers to measure PM in the final 40 CFR 1036.415(d)(1) but is modifying that requirement from proposal to include a final provision in this paragraph that EPA may request PM measurement and that manufacturers must provide that measurement if EPA requests it. Generally, EPA expects that test orders issued by EPA under 40 CFR 1036.405 will not include a requirement to measure PM.

Furthermore, EPA received comments on the subject of the need to measure NMHC emissions during in-use off-cycle testing of engines that comply with MY 2027 or later standards. After considering comments, EPA believes that historic test results from the manufacturer run in-use test program indicate that there is not an NMHC compliance problem for properly maintained engines. EPA is not including the proposed requirement for manufacturers to measure NMHC in the final 40 CFR 1036.415(d)(1) but is modifying that requirement from proposal to include a provision in this paragraph that EPA may request NMHC measurement and that manufacturers must provide that measurement if EPA requests it. Generally, EPA expects that

test orders issued by EPA under 40 CFR 1036.405 will not include a requirement to measure NMHC. See Response to Comment Section 11.5.5 for further information on these comments and EPA’s response to comments on the subject of in-use off-cycle standards PM and NMHC testing.

### iii. PEMS Accuracy Margin

EPA worked with engine manufacturers on a joint test program to establish measurement allowance values to account for the measurement uncertainty associated with in-use testing in the 2007-time frame for gaseous emissions and the 2010-time frame for PM emissions to support NTE in-use testing.<sup>297 298 299</sup> PEMS measurement allowance values in 40 CFR 86.1912 are 0.01 g/hp-hr for HC, 0.25 g/hp-hr for CO, 0.15 g/hp-hr for NO<sub>x</sub>, and 0.006 g/hp-hr for PM. We are maintaining the same values for HC, CO, and PM in this rulemaking. For NO<sub>x</sub> we are finalizing an off-cycle NO<sub>x</sub> accuracy margin (formerly known as measurement allowance) that is 5 percent of the off-cycle standard for a given bin. This final accuracy margin is supported by PEMS accuracy margin work at SwRI. The SwRI PEMS accuracy margin testing was done on the Stage 3 engine, which was tested over five field cycles with three different commercially available PEMS. EPA’s conclusion after assessing the results of that study, was that accuracy margins set at 0.4 g/hr for bin 1 and 5 mg/hp-hr for bin 2 were appropriate.

The accuracy margins we are finalizing differ from the 10 percent of the standard margin proposed in the NPRM, which was based on an earlier study by JRC. This SwRI PEMS accuracy margin study was on-going at the time the NPRM was published, and the results were only available post-NPRM publication.<sup>300</sup> However, the NPRM did note that we would consider the results of the SwRI PEMS study when they became available, and that the final off-cycle bin NO<sub>x</sub> standards could be

<sup>297</sup> Feist, M.D.; Sharp, C.A.; Mason, R.L.; and Buckingham, J.P. Determination of PEMS Measurement Allowances for Gaseous Emissions Regulated Under the Heavy-Duty Diesel Engine In-Use Testing Program. SwRI 12024, April 2007.

<sup>298</sup> Feist, M.D.; Mason, R.L.; and Buckingham, J.P. Additional Analyses of the Monte Carlo Model Developed for the Determination of PEMS Measurement Allowances for Gaseous Emissions Regulated Under the Heavy-Duty Diesel Engine In-Use Testing Program. SwRI® 12859, July 2007.

<sup>299</sup> Khalek, I.A.; Bougher, T.L.; Mason, R.L.; and Buckingham, J.P. PM-PEMS Measurement Allowance Determination. SwRI Project 03.14936.12, June 2010.

<sup>300</sup> The data and the results from the study were added to the public docket prior to the signing of the final rule.

higher or lower than what we proposed. EPA requested and received comments on the value of the PEMS accuracy margin for NO<sub>x</sub>; some commenters encouraged EPA to account for the SwRI PEMS accuracy work that was carried out on the Stage 3 engine. We initially planned to consider the results of this work and this was further supported through recommendations by some commenters; thus, we believe that incorporating the results of the latest study to determine an off-cycle NO<sub>x</sub> accuracy margin is appropriate. The SwRI PEMS study is further discussed in RIA Chapter 2. The study consisted of testing the Stage 3 engine with three commercially available PEMS units over 19 different tests. These tests were 6 to 9 hours long, covering a wide range of field operation. In addition, the Stage 3 engine was tested in three different configurations to cover the range of emissions levels expected from an engine both meeting and failing the final standards. We believe, based on this robust data set that was evaluating using the finalized test procedures, the SwRI study provides a more accurate assessment of PEMS measurement uncertainty from field testing of heavy-duty engines than what was determined from the JRC study that we relied on in the proposal for the proposed 10 percent margin. See Response to Comment Section 11.6 for further information on these comments and EPA’s response to these comments.

It should be noted that our off-cycle test procedures already include a linear zero and span drift correction over at least the shift day, and we are finalizing requirements for at least hourly zero drift checks over the course of the shift day on purified air. We believe that the addition of these checks and the additional improvements we implemented helped facilitate a measurement error that is lower than the analytically derived JRC value of 10 percent.<sup>301</sup>

We are updating 40 CFR 1065.935 to require hourly zeroing of the PEMS analyzers using purified air for all analyzers. We are also updating the drift limits for NO<sub>x</sub> analyzers to improve data quality. Specifically, for NO<sub>x</sub> analyzers, we are requiring an hourly or more frequent zero verification limit of 2.5 ppm, a zero-drift limit over the entire shift day of 10 ppm, and a span drift limit between the beginning and end of the shift day or more frequent span verification(s) of ±4 percent of the

<sup>301</sup> Giechaskiel B., Valverde V., Clairotte M. 2020 Assessment of Portable Emissions Measurement Systems (PEMS) Measurement Uncertainty. JRC124017, EUR 30591 EN. <https://publications.europa.eu/en/publications>.

measured span value. In the NPRM, we requested comment on the test procedure updates in 40 CFR 1065.935 and any changes that would reduce the PEMS measurement uncertainty. We received no comments on this topic other than a few minor edits and are finalizing these updates with minor edits for clarification.

iv. Demonstrating Off-Cycle Standards for Certification

Consistent with current certification requirements in 40 CFR 86.007–21(p)(1), we are finalizing a new paragraph in 40 CFR 1036.205(p) that requires manufacturers to provide a statement in their application for certification that their engine complies with the off-cycle standards, along with testing or other information to support that conclusion. We are finalizing this provision as proposed.

D. Summary of Spark-Ignition HDE Exhaust Emission Standards and Test Procedures

This section summarizes the exhaust emission standards, test procedures, and other requirements and flexibilities we are finalizing for certain spark-ignition (SI) heavy-duty engines. The exhaust emission provisions in this section apply for SI engines installed in vehicles above 14,000 lb GVWR and incomplete vehicles at or below 14,000 lb GVWR, but do not include engines voluntarily certified to or installed in vehicles subject to 40 CFR part 86, subpart S.

As described in this Section III.D, Spark-ignition HDE certification will continue to be based on emission performance in lab-based engine dynamometer testing, which will include a new SET duty cycle to address

high load operation. High load temperature protection and idle emission control requirements are also added to supplement our current FTP and new SET duty cycles. We are also lengthening the useful life and emissions-related warranty periods for all heavy-duty engines, including Spark-ignition HDE, as detailed in Sections IV.A and IV.B.1 of this preamble.

The final exhaust emission standards in 40 CFR 1037.104 apply starting in MY 2027. This final rule includes new standards over the FTP duty cycle currently used for certification, as well as new standards over the SET duty cycle to ensure manufacturers of Spark-ignition HDE are designing their engines to address emissions in during operation that is not covered by the FTP. The new standards are shown in Table III–20.

TABLE III–20—FINAL DUTY CYCLE EMISSION STANDARDS FOR SPARK-IGNITION HDE

Duty cycle	Model year 2026 and earlier <sup>a</sup>				Model year 2027 and later			
	NO <sub>x</sub> (mg/hp-hr)	HC (mg/hp-hr)	PM (mg/hp-hr)	CO (g/hp-hr)	NO <sub>x</sub> (mg/hp-hr)	HC (mg/hp-hr)	PM (mg/hp-hr)	CO (g/hp-hr)
SET .....	.....	.....	.....	.....	35	60	5	14.4
FTP .....	200	140	10	14.4	35	60	5	6.0

<sup>a</sup> Current emission standards for NO<sub>x</sub>, HC, and PM were converted from g/hp-hr to mg/hp-hr to compare with the final standards.

Our proposal included two options of fuel-neutral standards that applied the same numerical standards across all primary intended service classes. The proposed NO<sub>x</sub> and PM standards for the SET and FTP duty cycles were based on the emission performance of technologies evaluated in our HD CI engine technology demonstration program.<sup>302</sup> We based the proposed SET and FTP standards for HC and CO on HD SI engine performance.

Three organizations specifically expressed support for adopting the standards of proposed Option 1 for Spark-ignition HDE. The final standards are based largely on the emission levels of proposed Option 1, with some revisions to account for a single-step program, starting in MY 2027. Some organizations commented that the proposed SI standards were challenging enough to need the flexibility of ABT for HC and CO. Consistent with the proposal for this rule, we are finalizing an ABT program for NO<sub>x</sub> credits only and are discontinuing the current options for manufacturers to generate HC and PM credits. We did not request comment on and are not finalizing an

option for manufacturers to generate credits for CO. See Section IV.G of this preamble and section 12 of the Response to Comments document for more information on the final ABT program.

We are remaining generally consistent with a fuel neutral approach in the final SET and FTP standards, with the exception of CO for Spark-ignition HDE over the new SET duty cycle. We expand on our rationale for this deviation from fuel neutrality in Section III.D.1 where we also describe our rationale for the final program, including a summary of the feasibility demonstration, available data, and comments received.

After considering comments, we are revising three other proposed provisions for Spark-ignition HDE as described in Section . Two new requirements in 40 CFR 1036.115(j) focus on ensuring catalyst efficiency at low loads and proper thermal management at high loads. We are finalizing, with additional clarification, a new OBD flexibility for “sister vehicles”. We did not propose and are not finalizing separate off-cycle standards, manufacturer-run in-use testing requirements, or a low-load duty

cycle for Spark-ignition HDE at this time.<sup>303</sup>

The proposed rule provided an extensive discussion of the rationale and information supporting the proposed standards (87 FR 17479, March 28, 2022). The RIA includes additional information related to the range of technologies to control criteria emissions, background on applicable test procedures, and the full feasibility analysis for Spark-ignition HDE. See also section 3 of the Response to Comments for a detailed discussion of the comments and how they have informed this final rule.

1. Basis of the Final Exhaust Emission Standards and Test Procedures

EPA conducted a program with SwRI to better understand the emissions performance limitations of current heavy-duty SI engines as well as investigate the feasibility of advanced three-way catalyst aftertreatment and technologies and strategies to meet our proposed exhaust emission standards.<sup>304</sup> Our demonstration included the use of advanced catalyst

<sup>302</sup> Our assessment of the projected technology package for compression-ignition engines is based on both CARB’s and EPA’s technology demonstration programs. See Section III.B for a description of those technologies and test programs.

<sup>303</sup> See section 3 of the Response to Comments document for more information.

<sup>304</sup> Ross, M. (2022). Heavy-Duty Gasoline Engine Low NO<sub>x</sub> Demonstration. Southwest Research Institute. Final Report EPA Contract 68HERC20D0014.

technologies artificially aged to the equivalent of 250,000 miles and engine downspeeding. Our feasibility analyses for the exhaust emission standards are based on the SwRI demonstration program. Feasibility of the FTP standards is further supported by compliance data submitted by manufacturers for the 2019 model year. We also support the feasibility of the SET standards using engine fuel mapping data from a test program performed by the agency as part of the HD GHG Phase 2 rulemaking. See Chapter 3.2 of the RIA for more details related to the SwRI demonstration program and the two supporting datasets.

Results from our SI HDE technology demonstration program (see Table III–21 and Table III–22) show that the NO<sub>x</sub> standards based on our CI engine feasibility analysis are also feasible for SI HDEs over the SET and FTP duty cycles. The NO<sub>x</sub> standard was achieved

in this test program by implementing an advanced catalyst with minor catalyst system design changes, and NO<sub>x</sub> levels were further improved with engine down-speeding. The emission control strategies that we evaluated did not specifically target PM emissions, but we note that PM emissions remained low in our demonstration. We project SI HDE manufacturers will maintain near-zero PM levels with limited effort. The following sections discuss the feasibility of the HC and CO standards over each of the duty cycles and the basis for our final numeric standards’ levels.

i. Federal Test Procedure and Standards for Spark-Ignition HDE

After considering comments, we are finalizing FTP standards that differ from our proposed options for Spark-ignition HDE. We are finalizing standards of 35 mg/hp-hr NO<sub>x</sub>, 5 mg/hp-hr PM, 60 mg/hp-hr HC, and 6.0 g/hp-hr CO over the FTP duty cycle in a single step for MY

2027 and later engines. The NO<sub>x</sub> and HC standards match the MY 2027 step of proposed Option 1; the PM and CO standards match the MY 2031 step of Option 1. All of these standards were demonstrated to be technologically feasible in EPA’s SI engine test program.

As shown in Table III–21, use of advanced catalysts provided NO<sub>x</sub> emission levels over the FTP duty cycle well below today’s standards and below the certification levels of some of the best performing engines certified in recent years.<sup>305</sup> Engine down-speeding further decreased CO emissions while maintaining NO<sub>x</sub>, NMHC, and PM control. Engine down-speeding also resulted in a small improvement in fuel consumption over the FTP duty cycle, with fuel consumption being reduced from 0.46 to 0.45 lb/hp-hr. See Chapter 3.2.3 of the RIA for an expanded description of the test program and results.

TABLE III–21—EXHAUST EMISSION RESULTS FROM FTP DUTY CYCLE TESTING IN THE HD SI TECHNOLOGY DEMONSTRATION

	NO <sub>x</sub> (mg/hp-hr)	PM (mg/hp-hr)	HC (mg/hp-hr)	CO (g/hp-hr)
Current Standards MY 2026 and earlier .....	200	10	140	14.4
Final Standards MY 2027 and later .....	35	5	60	6
Test Program Base Engine with Advanced Catalyst <sup>a</sup> .....	19	4.8	32	4.9
Test Program Down-sped Engine with Advanced Catalyst <sup>b</sup> .....	18	4.5	35	0.25

<sup>a</sup> Base engine’s manufacturer-stated maximum test speed is 4715 RPM; advanced catalyst aged to 250,000 miles.

<sup>b</sup> Down-sped engine’s maximum test speed lowered to 4000 RPM; advanced catalyst aged to 250,000 miles.

All SI HDEs currently on the market use a three-way catalyst (TWC) to simultaneously control NO<sub>x</sub>, HC, and CO emissions.<sup>306</sup> We project most manufacturers will continue to use TWC technology and will also adopt advanced catalyst washcoat technologies and refine their existing catalyst thermal protection (fuel enrichment) strategies to prevent damage to engine and catalyst components over the longer useful life period we have finalized. We expect manufacturers, who design and have full access to the engine controls, could achieve similar emission performance as we demonstrated by adopting other, more targeted approaches, including a combination of calibration changes, optimized catalyst location, and fuel control strategies that EPA was unable to evaluate in our demonstration program due to limited access to proprietary engine controls.

In the proposal we described how the FTP duty cycle did not sufficiently incentivize SI HDE manufacturers to address fuel enrichment and the associated CO emissions that are common under higher load operations in the real-world. In response to our proposed rule, one manufacturer shared technical information with us regarding an SI engine architecture under development that is expected to reduce or eliminate enrichment and the associated CO emissions.<sup>307</sup> The company indicated that the low CO emissions may come at the expense of HC emission reduction in certain operation represented by the FTP duty cycle, and reiterated their request for an 80 mg/hp-hr HC standard, as was stated in their written comments. We are not finalizing an HC standard of 80 mg/hp-hr as requested in comment. For the FTP duty cycle, the EPA test program achieved HC levels more than half of the

requested level without compromising NO<sub>x</sub> or CO emission control (see Table III–21), which clearly demonstrates feasibility.

While we demonstrated emission levels below the final standards of 60 mg HC/hp-hr and 35 mg NO<sub>x</sub>/hp-hr over the FTP duty cycle in our SI HDE testing program, we expect manufacturers to apply a compliance margin to their certification test results to account for uncertainties, such as production variation. Additionally, we believe manufacturers would have required additional lead time to implement the demonstrated emission levels broadly across all heavy-duty SI engine platforms for the final useful life periods. Since we are finalizing a single-step program starting in MY 2027, as discussed in Section III.A.3 of this preamble, we continue to consider 60 mg HC/hp-hr and 35 mg NO<sub>x</sub>/hp-hr the appropriate level of the standards for

<sup>305</sup> As presented in Chapter 3.2 of the RIA, MY 2019 gasoline-fueled HD SI engine certification results included NO<sub>x</sub> levels ranging from 40 to 240 mg/hp-hr at a useful life of 110,000 miles. MY 2019–2021 alternative-fueled (CNG, LPG) HD SI

engine certification results included NO<sub>x</sub> levels ranging from 6 to 70 mg/hp-hr at the same useful life.

<sup>306</sup> See Chapter 1.2 of the RIA for a detailed description of the TWC technology and other

strategies HD SI manufacturers use to control criteria emissions.

<sup>307</sup> U.S. EPA. Stakeholder Meeting Log. December 2022.

that model year, as proposed in the MY 2027 step of proposed Option 1.

ii. Supplemental Emission Test and Standards for Spark-Ignition HDE

The existing SET duty cycle, currently only applicable to CI engines, is a ramped modal cycle covering 13 steady-state torque and engine speed points that is intended to exercise the engine over sustained higher load and higher speed operation. Historically, in light of the limited range of applications and sales volumes of SI heavy-duty engines, especially compared to CI engines, we believed the FTP duty cycle was sufficient to represent the high-load and high-speed operation of SI engine-powered heavy-duty vehicles. As the market for SI engines increases for use in larger vehicle classes, these engines are more likely to operate under extended high-load conditions. To

address these market shifts, we proposed to apply the SET duty cycle and new SET standards to Spark-ignition HDE, starting in model year 2027. This new cycle would ensure that emission controls are properly functioning in the high load and speed conditions covered by the SET.

We are finalizing the addition of the SET duty cycle for the Spark-ignition HDE primary intended service class, as proposed.<sup>308</sup> We requested comment on revisions we should consider for the CI-based SET procedure to adapt it for SI engines. We received no comments on changes to the procedure itself and the SET standards for Spark-ignition HDE are based on the same SET procedure as we are finalizing for heavy-duty CI engines. After considering comments, we are finalizing SET standards that differ from our proposed options for Spark-ignition HDE.

The EPA HD SI technology demonstration program evaluated emission performance over the SET duty cycle. As shown in Table III–22, the NO<sub>x</sub> and NMHC emissions over the SET duty cycle were substantially lower than the emissions from the FTP duty cycle (see Table III–21). Lower levels of NMHC were demonstrated, but at the expense of increased CO emissions in those higher load operating conditions. Engine down-speeding improved CO emissions significantly, while NO<sub>x</sub>, NMHC, and PM remained low.<sup>309</sup> The considerably lower NO<sub>x</sub> and HC in our SET duty cycle demonstration results leave enough room for manufacturers to calibrate the tradeoff in TWC emission control of NO<sub>x</sub>, HC, and CO to continue to fine-tune CO. See Chapter 3.2 of the RIA for an expanded description of the test program and results.

TABLE III–22—EXHAUST EMISSION RESULTS FROM SET DUTY CYCLE TESTING IN THE HD SI TECHNOLOGY DEMONSTRATION

	NO <sub>x</sub> (mg/hp-hr)	PM (mg/hp-hr)	HC (mg/hp-hr)	CO (g/hp-hr)
Final Standards MY 2027 and later .....	35	5	60	14.4
Test Program Base Engine with Advanced Catalyst <sup>a</sup> .....	8	<sup>c</sup> 7	6	36.7
Test Program Down-spiced Engine with Advanced Catalyst <sup>b</sup> .....	5	3	1	7.21

<sup>a</sup> Base engine’s manufacturer-stated maximum test speed is 4715 RPM; advanced catalyst aged to 250,000 miles.

<sup>b</sup> Down-spiced engine’s maximum test speed lowered to 4000 RPM; advanced catalyst aged to 250,000 miles.

<sup>c</sup> As noted in Chapter 3.2 of the RIA, the higher PM value was due to material separating from the catalyst mat during the test and is not indicative of the engine’s ability to control engine-generated PM emissions at the higher load conditions of the SET.

Similar to our discussion related to the FTP standards, we expect manufacturers, who design and have full access to the engine controls, could achieve emission levels comparable to or lower than our feasibility demonstration over the SET duty cycle by adopting other approaches, including a combination of calibration changes, optimized catalyst location, and fuel control strategies that EPA was unable to evaluate due to limited access to proprietary engine controls. In fact, we are aware of advanced engine architectures that can reduce or eliminate enrichment, and the associated CO emissions, by maintaining closed loop operation.<sup>310</sup>

We proposed Spark-ignition HDE standards for HC and CO emissions on the SET cycle that were numerically equivalent to the respective proposed FTP standards. Our intent was to ensure that SI engine manufacturers utilize

emission control hardware and calibration strategies to control emissions during high load operation to levels similar to the FTP duty cycle.<sup>311</sup> We retain this approach for HC, but, after considering comments, the final CO standard is revised from that proposed. One commenter indicated that manufacturers would need CO credits to achieve the proposed standards. Another commenter suggested that EPA underestimated the modifications manufacturers would need to make to fully transition away from the fuel enrichment strategies they currently use to protect their engines. The same commenter requested that EPA delay the SET to start in model year 2031 or temporarily exclude the highest load points over the test to provide additional lead time for manufacturers.

We are not finalizing an option for manufacturers to generate CO credits.

We believe a delayed implementation of SET, as requested, would further delay manufacturers’ motivation to focus on high load operation to reduce enrichment and the associated emissions reductions that would result. Additionally, our objective for adding new standards over the SET duty cycle is to capture the prolonged, high-load operation not currently represented in the FTP duty cycle, and the commenter’s recommendation to exclude the points of highest load would be counter to that objective.

We agree with commenters that the new SET duty cycle and standards will be a challenge for heavy-duty SI manufacturers but maintain that setting a feasible technology-forcing CO standard is consistent with our authority under the CAA. After further considering the comments and assessing CO data from the EPA heavy-duty SI test program, the final new CO standard we

<sup>308</sup> See our updates to the SET test procedure in 40 CFR 1036.505.

<sup>309</sup> Engine down-speeding also resulted in a small improvement in brake specific fuel consumption over the SET duty cycle reducing from 0.46 to 0.44 lb/hp-hr.

<sup>310</sup> See Chapter 1 of the RIA for a description of fuel enrichment, when engine operation deviates from closed loop, and its potential impact on emissions.

<sup>311</sup> Test results presented in Chapter 3.2 of the RIA indicate that these standards are achievable

when the engine controls limit fuel enrichment and maintain closed loop control of the fuel-air ratio.

are adopting is less stringent than proposed to provide manufacturers additional margin for ensuring compliance with that pollutant's standard over the new test procedure for Spark-ignition HDE. Given this final standard, we determined that neither ABT or more lead time are appropriate or required. The Spark-ignition HDE standard for CO emissions on the SET duty-cycle established in this final rule is numerically equivalent to the current FTP standard of 14.4 g/hp-hr.

## 2. Other Provisions for Spark-Ignition HDE

This Section III.D.2 describes other provisions we proposed and are finalizing with revisions from proposal in this rule. The following three provisions address information manufacturers will share with EPA as part of their certification and we are adding clarification where needed after considering comments. See also section 3 of the Response to Comments for a detailed discussion of the comments summarized in this section and how they have informed the updates we are finalizing for these three provisions.

### Idle Control for Spark-Ignition HDE

We proposed to add a new paragraph at 40 CFR 1036.115(j)(1) to require manufacturers to show how they maintain a catalyst bed temperature of 350 °C in their application for certification or get approval for an alternative strategy that maintains low emissions during idle. As described in Chapter 3.2 of the RIA, prolonged idling events may allow the catalyst to cool and reduce its efficiency, resulting in emission increases until the catalyst temperatures increase. Our recent HD SI test program showed idle events that extend beyond four minutes allow the catalyst to cool below the light-off temperature of 350 °C. The current heavy-duty SET and FTP duty cycles do not include sufficiently long idle periods to represent these real-world conditions where the exhaust system cools below the catalyst's light-off temperature.

We continue to believe that a 350 °C lower bound for catalysts will sufficiently ensure emission control is maintained during idle without additional manufacturer testing. We are finalizing the 350 °C target and the option for manufacturers to request approval for a different strategy, as proposed. We are revising the final requirement from our proposal to also allow manufacturers to request approval of a temperature lower than 350 °C, after considering comments that requested that we replace the 350 °C temperature

with the more generic "light-off temperature" to account for catalysts with other formulations or locations relative to the engine.

### i. Thermal Protection Temperature Modeling Validation

The existing regulations require manufacturers to report any catalyst protection strategy that reduces the effectiveness of emission controls as an AECD in their application for certification.<sup>312</sup> The engine controls used to implement these strategies often rely on a modeling algorithm to predict high exhaust temperatures and to disable the catalyst, which can change the emission control strategy and directly impact real world emissions. The accuracy of these models used by manufacturers is critical in both ensuring the durability of the emission control equipment and preventing excessive emissions that could result from unnecessary or premature activation of thermal protection strategies.

To ensure that a manufacturer's model accurately estimates the temperatures at which thermal protection modes are engaged, we proposed a validation process during certification in a new paragraph 40 CFR 1036.115(j)(2) to demonstrate the model performance.

Several commenters opposed the proposed requirement that manufacturers demonstrate a 5 °C accuracy between modelled and actual exhaust and emission component temperatures and expressed concern with the ability to prove correlation at this level and lack of details on the procedure for measuring the temperatures. Our final, revised approach still ensures EPA has the information needed to appropriately assess a manufacturer's AECD strategy, without a specific accuracy requirement.

Our final 40 CFR 1036.115(j)(2) clarifies that the new validation process is a requirement in addition to the requirements for any SI engine applications for certification that include an AECD for thermal protection.<sup>313</sup> Instead of the proposed 5 °C accuracy requirement, a manufacturer will describe why they rely on any AECDs, instead of other engine designs, for thermal protection of catalyst or other emission-related components. They will also describe the

accuracy of any modeled or measured temperatures used to activate the AECD. Instead of requiring manufacturers to submit second-by-second data upfront in the application for certification to demonstrate a specific accuracy requirement is met, the final requirement gives EPA discretion to request the information at certification. We note that our final revised requirements apply the same validation process for modeled and measured temperatures that activate an AECD and that this requirement would not apply if manufacturers certify their engines without an AECD for enrichment as thermal protection.

### ii. OBD Flexibilities

In recognition that there can be some significant overlap in the technologies and emission control systems adopted for products in the chassis-certified and engine-certified markets, we proposed an OBD flexibility to limit the data requirements for engine-certified products that use the same engines and generally share similar emission controls (*i.e.*, are "sister vehicles") with chassis-certified products. Specifically, in a new 40 CFR 1036.110(a)(2), we proposed to allow vehicle manufacturers the option to request approval to certify the OBD of their SI, engine-certified products using data from similar chassis-certified Class 2b and Class 3 vehicles that meet the provisions of 40 CFR 86.1806–17.

Two organizations commented in support of the proposed OBD flexibility and with one suggesting some revisions to the proposed regulatory language. The commenter suggested that the expression 'share essential design characteristics' was too vague, and requested EPA provide more specific information on what EPA will use to make their determination. We disagree that more specific information is needed. We are relying on the manufacturers to identify the design characteristics and justify their request as part of the certification process. We are adjusting the final regulatory text to clarify how the vehicles above and below 14,000 lbs GVWR must use the same engine and share similar emission controls, but are otherwise finalizing this OBD flexibility as proposed.

### E. Summary of Spark-Ignition HDV Refueling Emission Standards and Test Procedures

All sizes of complete and incomplete heavy-duty vehicles have been subject to evaporative emission standards for many years. Similarly, all sizes of complete heavy-duty vehicles are subject to refueling standards. We most

<sup>312</sup> See 40 CFR 86.094–21(b)(1)(i) and our migration of those provisions to final 40 CFR 1036.205(b).

<sup>313</sup> These requirements are in place today under existing 40 CFR 86.094–21(b)(1)(i), which have been migrated to 40 CFR 1036.205(b) in this final rule.

recently applied the refueling standards to complete heavy-duty vehicles above 14,000 pounds GVWR starting with model year 2022 (81 FR 74048, Oct. 25, 2016).

We proposed to amend 40 CFR 1037.103 to apply the same refueling standard of 0.20 grams hydrocarbon per gallon of dispensed fuel to incomplete heavy-duty vehicles above 14,000 pounds GVWR starting with model year 2027 over a useful life of 150,000 miles or 15 years (whichever comes first). We further proposed to apply the same testing and certification procedures that currently apply for complete heavy-duty vehicles. We are adopting this standard and testing and certification procedures as proposed, with some changes to the proposed rule as noted in this section. As noted in 40 CFR 1037.103(a)(2), the standards apply for vehicles that run on gasoline, other volatile liquid fuels, and gaseous fuels.

The proposed rule provided an extensive discussion of the history of evaporative and refueling standards for heavy-duty vehicles, along with rationale and information supporting the proposed standards (87 FR 17489, March 28, 2022). The RIA includes additional information related to control technology, feasibility, and test procedures. See also section 3 of the Response to Comments for a detailed discussion of the comments and the changes we made to the proposed rule.

Some commenters advocated for applying the refueling standards also to incomplete heavy-duty vehicles at or below 14,000 pounds GVWR. Specifically, some manufacturers commented that they would need a phase-in schedule that allowed more lead time beyond the proposed MY 2027 start of the refueling standards for incomplete vehicles above 14,000 pounds GVWR, and that EPA should consider a longer phase-in that also included refueling standards for incomplete vehicles at or below 14,000 pounds GVWR. In EPA's judgment, the design challenge for meeting the new refueling standards will mainly involve larger evaporative canisters, resizing purge valves, and recalibrating for higher flow of vapors from the evaporative canister into the engine's intake. Four years of lead time is adequate for designing, certifying, and implementing these design solutions. We are therefore finalizing the proposed start of refueling standards in MY 2027 for all incomplete heavy-duty vehicles above 14,000 pounds GVWR.

At the same time, as manufacturers suggested, expanding the scope of certification over a longer time frame may be advantageous for implementing

design changes across their product line in addition to the environmental gain from applying refueling controls to a greater number of vehicles. We did not propose refueling standards for vehicles at or below 14,000 pounds GVWR and we therefore do not adopt such standards in this final rule. However, the manufacturers' suggestion to consider a package of changes to both expand the scope of the standards and increase the lead time for meeting standards has led us to adopt an optional alternative phase-in. Under the alternative phase-in compliance pathway, instead of certifying all vehicles above 14,000 pounds GVWR to the refueling standard in MY 2027, manufacturers can opt into the alternate phase-in that applies for all incomplete heavy-duty vehicles, regardless of GVWR. The alternative phase-in starts at 40 percent of production in MYs 2026 and 2027, followed by 80 percent of production in MYs 2028 and 2029, ramping up to 100 percent of production in MY 2030. Phase-in calculations are based on projected nationwide production volume of all incomplete heavy-duty vehicles subject to refueling emission standards under 40 CFR 86.1813–17. Specifying the phase-in schedule in two-year increments allows manufacturers greater flexibility for integrating emission controls across their product line.

Manufacturers may choose either schedule of standards; however, they must satisfy at least one of the two. That is, if manufacturers do not certify all their incomplete heavy-duty vehicles above 14,000 pounds GVWR to the refueling standards in MY 2027, the alternate phase-in schedule described in 40 CFR 86.1813–17(b) becomes mandatory to avoid noncompliance. Conversely, if manufacturers do not meet the alternative phase-in requirement for MY 2026, they must certify all their incomplete heavy-duty vehicles above 14,000 pounds GVWR to the refueling standard in MY 2027 to avoid noncompliance. See the final 40 CFR 86.1813–17(b) for the detailed specifications for the alternative phase-in schedule.

We received several comments suggesting that we adjust various aspects of the testing and certification procedures for heavy-duty vehicles meeting the evaporative and refueling standards. Consideration of these comments led us to include some changes from proposal for the final rule. First, we are revising 40 CFR 1037.103 to add a reference to the provisions from 40 CFR part 86, subpart S, that are related to the refueling standards. This is intended to make clear that the

overall certification protocol from 40 CFR part 86, subpart S, applies for heavy-duty vehicles above 14,000 pounds GVWR (see also existing 40 CFR 1037.201(h)). This applies, for example, for durability procedures, useful life, and information requirements for certifying vehicles. Along those lines, we are adding provisions to 40 CFR 86.1821–01 to clarify how manufacturers need to separately certify vehicles above 14,000 pounds GVWR by dividing them into different families even if they have the same design characteristics as smaller vehicles. This is consistent with the way we have been certifying vehicles to evaporative and refueling standards.

Second, we are modifying the test procedures for vehicles with fuel tank capacity above 50 gallons. These vehicles have very large quantities of vapor generation and correspondingly large evaporative and refueling canisters. The evaporative test procedures call for manufacturers to design their vehicles to purge a canister over about 11 miles of driving (a single FTP duty cycle) before the diurnal test, which requires the vehicle to control the vapors generated over two simulated hot summer days of parking. We share manufacturers' concern that the operating characteristics of these engines and vehicles do not support achieving that level of emission control. We are therefore revising the two-day diurnal test procedure at 40 CFR 86.137–94(b)(24) and the Bleed Emission Test Procedure at 40 CFR 86.1813–17(a)(2)(iii) to include a second FTP duty cycle with an additional 11 miles of driving before starting the diurnal measurement procedure.

Third, manufacturers pointed out that the existing test procedures don't adequately describe how to perform a refueling emission measurement with vehicles that have two fuel tanks with separate filler necks. We are amending the final rule to include a provision to direct manufacturers to use good engineering judgment for testing vehicles in a dual-tank configuration. It should be straightforward to do the testing with successive refills for the two tanks and combining the measured values into a single result. Rather than specifying detailed adjustments to the procedure, allowing manufacturers the discretion to perform that testing and computation consistent with good engineering judgment will be enough to ensure a proper outcome.

Table III–23 summarizes the cost estimations for the different technological approaches to controlling refueling emissions that EPA evaluated. See Chapter 3.2.3.2 of the RIA for the

details. In calculating the overall cost, we used \$25 (2019 dollars), the average of both approaches, to represent the cost for manufacturers to adopt the

additional canister capacity and hardware to meet our new refueling emission standards for incomplete vehicles above 14,000 lb GVWR. See

also Section V of this preamble for a summary of our overall program cost and Chapter 7 of the RIA for more details on our overall program cost.

TABLE III–23—SUMMARY OF PROJECTED PER-VEHICLE COSTS TO MEET THE REFUELING EMISSION STANDARDS

	Liquid seal		Mechanical seal	
	New canister	Dual existing canisters in series	New canister	Dual existing canisters in series
Additional Canister Costs .....	\$20	\$15	\$8	\$8
Additional Tooling <sup>a</sup> .....	0.50		0.50	
Flow Control Valves .....	6.50		6.50	
Seal .....	0	0	10	
Total .....	27	22	25	

<sup>a</sup> Assumes the retooling costs are spread over a five-year period.

Incomplete vehicles above 14,000 lb GVWR with dual fuel tanks may require some unique accommodations to adopt onboard refueling vapor recovery (ORVR) systems. A chassis configuration with dual fuel tanks would need separate canisters and separate filler pipes and seals for each fuel tank. Depending on the design, a dual fuel tank chassis configuration may require a separate purge valve for each fuel tank. We assume manufacturers will install one additional purge valve for dual fuel tank applications that also incorporate independent canisters for the second fuel tank/canister configuration, and that manufacturers adopting a mechanical seal in their filler pipe will install an anti-spitback valve for each filler pipe. See Chapter 1.2.4.5 of the RIA for a summary of the design considerations for these fuel tank configurations. We did not include an estimate of the impact of dual fuel tank vehicles in our cost analysis of the new refueling emission standards, as the population of these vehicles is very low and we expect minimal increase in the total average costs.

**IV. Compliance Provisions and Flexibilities**

EPA certification is a fundamental requirement of the Clean Air Act for manufacturers of heavy-duty highway engines. EPA has employed significant discretion over the past several decades in designing and updating many aspects of our heavy-duty engine and vehicle certification and compliance programs. In the following sections, we discuss several revised provisions that we believe will increase the effectiveness of our regulations.

As noted in Section I, we are migrating our criteria pollutant

regulations for model years 2027 and later heavy-duty highway engines from their current location in 40 CFR part 86, subpart A, to 40 CFR part 1036.<sup>314</sup> Consistent with this migration, the compliance provisions discussed in this section refer to the final regulations in their new location in part 1036. In general, this migration is not intended to change the compliance program specified in part 86, except as specifically finalized in this rulemaking. See Section III.A.1.

*A. Regulatory Useful Life*

Useful life represents the period over which emission standards apply for certified engines, and, practically, any difference between the regulatory useful life and the generally longer operational life of in-use engines represents miles and years of operation without an assurance that emission standards will continue to be met. In addition to promulgating new emission standards and promulgating new and updating existing test procedures described in Section III, we are updating regulatory useful life periods to further assure emission performance of heavy-duty highway engines. In this section, we present the updated regulatory useful life periods we are finalizing in this rule. In Section IV.A.1, we present our revised useful life periods that will apply for the new exhaust emission standards for criteria pollutants, OBD, and requirements related to crankcase emissions. In Section IV.A.2, we present the useful life periods that will apply for the new refueling emission standards

for certain Spark-ignition HDE. As described in Section G.10 of this preamble, we are not finalizing the proposed allowance for manufacturers to generate NO<sub>x</sub> emissions credits from heavy-duty zero emissions vehicles (ZEVs) or the associated useful life requirements.

1. Regulatory Useful Life Periods by Primary Intended Service Class

In this final rule, we are increasing the regulatory useful life mileage values for new heavy-duty engines to better reflect real-world usage, extend the emissions durability requirement for heavy-duty engines, and improve long-term emission performance. In this Section IV.1, we describe the regulatory useful life periods we are finalizing for the four primary intended service classes for heavy-duty highway engines.<sup>315</sup> Our longer useful life periods vary by engine class to reflect the different lengths of their estimated operational lives. As described in the proposal for this rule, we continue to consider operational life to be the average mileage at rebuild for CI engines and the average mileage at replacement for SI engines.<sup>316</sup>

In determining the appropriate longer useful life values to set in the final rule, we retain our proposed objective to set useful life periods that cover a significant portion of the engine’s operational life. However, as explained in the proposal, we also maintain that

<sup>315</sup> The useful life periods we are finalizing in this rule apply for criteria pollutant standards; we did not propose and are not finalizing changes to the useful life periods that apply for GHG standards.

<sup>316</sup> See Chapter 2.4 of the RIA for a summary of the history of our regulatory useful life provisions and our estimate of the operational life for each heavy-duty engine class.

<sup>314</sup> As noted in the following sections, we are finalizing some updates to 40 CFR parts 1037, 1065, and 1068 to apply to other sectors in addition to heavy-duty highway engines.



the emission standards presented in Section III must be considered together with their associated useful life periods. After further consideration of the basis for the proposal, comments received, supporting data available since the proposal, and the numeric level of the final standards, we are selecting final useful life values within the range of options proposed that cover a significant portion of the engine's operational life and take into account the combined effect of useful life and the final numeric standards on the overall stringency and emissions reductions of the program. As described in the final RIA, we concluded two engine test programs for this rule that demonstrated technologies that are capable of meeting lower emission levels at much longer mileages than current useful life periods. We evaluated a heavy-duty diesel engine to

a catalyst-aged equivalent of 800,000 miles for the compression-ignition demonstration program, and a heavy-duty gasoline engine to a catalyst-aged equivalent of 250,000 miles for the spark-ignition demonstration program. As described in Section III of this preamble, the results of those demonstration programs informed the appropriate standard levels for the useful life periods we are finalizing for each engine class. Our final useful life values were also informed by comments, including additional information on uncertainties and potential corresponding costs. We summarize key comments in Section IV.1.ii, and provide complete responses to useful life comments in section 3.8 of the Response to Comments document. Our final useful life periods for Spark-ignition HDE, Light HDE, Medium HDE, and Heavy HDE classes are presented in Table IV-1 and specified in a new 40

CFR 1036.104(e).<sup>317</sup> The final useful life values that apply for Spark-ignition HDE, Light HDE, and Medium HDE starting in MY 2027 match the most stringent option we proposed, that is, MY 2031 step of proposed Option 1. The final useful life values for Heavy HDE, which has a distinctly longer operational life than the smaller engine classes, match the longest useful life mileage we proposed for model year 2027 (*i.e.*, the Heavy HDE mileage of proposed Option 2). We are also increasing the years-based useful life from the current 10 years to values that vary by engine class and match the proposed value in the respective proposed option. After considering comments, we are also adding hours-based useful life values to all primary intended service classes based on a 20 mile per hour speed threshold and the corresponding final mileage values.

TABLE IV-1—FINAL USEFUL LIFE PERIODS BY PRIMARY INTENDED SERVICE CLASS

Primary intended service class	Current			MY 2027 and later		
	Miles	Years	Hours	Miles	Years	Hours
Spark-ignition HDE <sup>a</sup>	110,000	10		200,000	15	10,000
Light HDE <sup>a</sup>	110,000	10		270,000	15	13,000
Medium HDE	185,000	10		350,000	12	17,000
Heavy HDE	435,000	10	22,000	650,000	11	32,000

<sup>a</sup> Current useful life period for Spark-ignition HDE and Light HDE for GHG emission standards is 15 years or 150,000 miles; we are not revising these useful life periods in this final rule. See 40 CFR 1036.108(d).

For hybrid engines and powertrains, we are finalizing the proposal that manufacturers certifying hybrid engines and powertrains would declare the primary intended service class of their engine family using 40 CFR 1036.140. Once a primary intended service class is declared, the engine configuration would be subject to the corresponding emission standards and useful life values from 40 CFR 1036.104.

i. Summary of the Useful Life Proposal

For CI engines, the proposed Option 1 useful life periods included two steps in MYs 2027 and 2031 that aligned with the final useful life periods of CARB's HD Omnibus regulation, and the proposed MY 2031 periods covered close to 80 percent of the expected operational life of CI engines based on mileage at out-of-frame rebuild. The useful life mileages of proposed Option 2, which was a single-step option starting in MY 2027, generally corresponded to the average mileages at

which CI engines undergo the first in-frame rebuild. The rebuild data indicated that CI engines can last well beyond the in-frame rebuild mileages. We noted in the proposal that it was unlikely that we would finalize a single step program with useful life mileages shorter than proposed Option 2; instead, we signaled that we would likely adjust the numeric value of the standards to address any feasibility concerns.

For Spark-ignition HDE, the useful life mileage in proposed Option 1 was about 90 percent of the operational life of SI engines based on mileage at replacement. The useful life of proposed Option 2 aligned with the current SI engine useful life mileage that applies for GHG standards. In the proposal, we noted that proposed Option 2 also represented the lowest useful life mileage we would consider finalizing for Spark-ignition HDE.

In proposed Option 1, we increased the years-based useful life values for all engine classes to account for engines

that accumulate fewer miles annually. We also proposed to update the hours-based useful life criteria for the Heavy HDE class to account for engines that operated frequently, but accumulated relatively few miles due to lower vehicle speeds. We calculated the proposed hours values by applying the same 20 mile per hour conversion factor to the proposed mileages as was applied when calculating the useful life hours that currently apply for Heavy HDE.<sup>318</sup> The proposed hours specification was limited to the Heavy HDE class to be consistent with current regulations, but we requested comment on adding hours-based useful life values to apply for the other service classes.

ii. Basis for the Final Useful Life Periods

In this Section IV.1.ii, we provide the rationale for our final useful life periods, including summaries and responses to certain comments that informed our final program. The complete set of useful life comments

<sup>317</sup> We are migrating the current alternate standards for engines used in certain specialty vehicles from 40 CFR 86.007-11 and 86.008-10 into 40 CFR 1036.605 without modification. See Section

XI.B of this preamble for a discussion of these standards.

<sup>318</sup> U.S. EPA, "Summary and Analysis of Comments: Control of Emissions of Air Pollution

from Highway Heavy-Duty Engines", EPA-420-R-97-102, September 1997, pp 43-47.

and our responses are in section 3.8 of the Response to Comments document. As explained in the NPRM, CAA section 202(d) provides that the minimum useful life for heavy-duty vehicles and engines is a period of 10 years or 100,000 miles, whichever occurs first, and further authorizes EPA to adopt longer useful life periods that we determine to be appropriate.

Many commenters expressed general support for our proposal to lengthen useful life periods in this rulemaking. Several commenters expressed specific support for the useful life periods of proposed Option 1 or proposed Option 2. Other commenters recommended EPA revise the proposal to either lengthen or shorten the useful life periods to values outside of the range of our proposed options.

We are lengthening the current useful life mileages to capture the greatest amount of the operational life for each engine class that we have determined is appropriate at this time. We disagree with commenters recommending that we finalize useful life periods below the mileages of proposed Option 2. As noted in our proposal, proposed Option 2 represented the lower bound of useful life mileages we would consider finalizing for all engine classes. Furthermore, as described in Section III of this preamble and Chapter 3 of the RIA for this final rule, both of EPA's engine test programs successfully demonstrated that CI and SI engine technologies can achieve low emission levels at mileages (800,000 miles and 250,000 miles, respectively) well beyond Option 2. Even after taking into consideration uncertainties of the impacts of variability and real world operation on emission levels at the longest mileages, the test programs' data supports that mileages at least as long as Option 2 are appropriate, and the final standards are feasible at those mileages. We also disagree with commenters suggesting we finalize mileages longer than proposed Option 1. We did not propose and for the reasons just explained about impacts on emission level at the longest mileages do not believe it is appropriate at this time to require useful life periods beyond proposed Option 1.

Organizations submitting adverse comments on useful life focused mostly on the useful life mileages proposed for the Heavy HDE service class. Technology suppliers and engine manufacturers expressed concern with the lack of data from engines at mileages well beyond the current useful life. Suppliers commented that it could be costly and challenging to design components without more information

on component durability, failure modes, and use patterns at high mileages. Engine manufacturers claimed that some uncertainties relating to real world use would limit the feasibility of the proposed Option 1 useful life periods, including: The range of applications in which these engines are used, variable operator behavior (including 2nd and 3rd owners), and the use of new technology that is currently unproven in the field. In Sections III and IV.F of this preamble, we describe other areas where useful life plays a role and manufacturers expressed concern over uncertainties, including certification, DF testing, engine rating differences, lab-to-lab variability, production variability, and in-use engine variability. Due to these combined uncertainties, manufacturers stated that they expect to be conservative in their design and maintenance strategies, and some may opt to schedule aftertreatment replacement as a means to ensure compliance with new NO<sub>x</sub> emission standards, particularly for proposed Option 1 numeric standards and useful life values. Comments did not indicate a concern that manufacturers may schedule aftertreatment replacement for the smaller engine classes at the proposed Option 1 useful life periods.

We agree that there are uncertainties associated with implementing new technology to meet new emission standards, and recognize that the uncertainties are highest for Heavy HDE that are expected to have the longest operational life and useful life periods. We acknowledge that higher useful life mileage is one factor that may contribute to a risk that manufacturers would schedule aftertreatment replacement to ensure compliance for the heaviest engine class. Specific to Heavy HDE, the final useful life mileage of 650,000 miles matches the longest useful life mileage we proposed for model year 2027 and we expect manufacturers have experience with their engines at this mileage through their extended warranty offerings, thus reducing uncertainties of real world operation compared to the longest useful life mileage we proposed (*i.e.*, 800,000 miles).<sup>319</sup> For Heavy HDE, the final numeric emission standards and useful life periods matching proposed Option 2, combined with other test procedure revisions to provide clarity and address variability, will require less conservative compliance strategies than proposed Option 1 and will not require

manufacturers to plan for the replacement of the entire catalyst system. See Section III for further discussion on the basis and feasibility of the final emission standards.

Many commenters supported proposed Option 1, including useful life periods out to 800,000 miles for the Heavy HDE class. Several commenters pointed to EPA's engine testing results on an engine aged to the equivalent of 800,000 miles as adequately demonstrating feasibility of an 800,000-mile useful life for Heavy HDE. We agree that CI engines are capable of meeting low emission levels at very high mileages in a controlled laboratory environment, but manufacturer liability for maintaining certified emission levels over the regulatory useful life period is not restricted to laboratory tests. Manufacturers expressed specific concern about the uncertainties outside the controlled laboratory environment after an engine enters commerce. In Sections III and IV.F of this preamble we summarize comments relating to how useful life factors into certification, DF testing, and in-use testing. In Section III.B, we describe a certification requirement we are finalizing for manufacturers to demonstrate the emission controls on Heavy HDE are durable through the equivalent of 750,000 miles; this durability demonstration will extend beyond the 650,000 mile useful life period for these engines. We expect this extended laboratory-based demonstration, in a controlled environment, will translate to greater assurance that an engine will maintain its certified emission levels in real world operation where conditions are more variable throughout the regulatory useful life. This greater assurance would be achieved while minimizing the compliance uncertainties identified by manufacturers in comments for the highest proposed useful life mileages.

We believe manufacturers can adequately ensure the durability of their smaller engines over useful life periods that match proposed Option 1 both for meeting emission standards in the laboratory at certification and in the laboratory and applicable in-use testing after operation in the real world. The final durability demonstration requirements for Spark-ignition HDE, Light HDE, and Medium HDE match the final useful life periods for those smaller engines classes.

As shown in Table IV-1, we are also finalizing useful life periods in years and hours for all primary intended service classes. We are updating the years values from the current 10 years to 15 years for Spark-ignition HDE and

<sup>319</sup> Brakora, Jessica. Memorandum to docket EPA-HQ-OAR-2019-0055. "Example Extended Warranty Packages for Heavy-duty Engines". September 29, 2022.

Light HDE, 12 years for Medium HDE, and 11 years for Heavy HDE. The final years values match the years values we proposed and vary by engine class corresponding to the proposed mileage option we are finalizing. We are also adding hours as a useful life criteria for all engine classes. We received no adverse comments for hours-based useful life periods and are finalizing hours values by applying a 20-mph conversion factor, as proposed, to calculate hours values from the final mileage values.

We have finalized a combination of emissions standards and useful life values that our analysis and supporting data demonstrate are feasible for all heavy-duty engine classes. We are lengthening the existing useful life mileages to capture the greatest amount of the operational life for each engine class that we have determined is appropriate at this time, while considering the impact of useful life length on the stringency of the standards and other requirements of this final rule. Preamble Section III describes how our analysis and the EPA engine test programs demonstrated feasibility of the standards at these useful life values, including data on emission levels at the equivalent useful life mileages.

## 2. Useful Life for Incomplete Vehicle Refueling Emission Standards

As described in Section III.E., we are finalizing a refueling emission standard for incomplete vehicles above 14,000 lb GVWR. Manufacturers would meet the refueling emission standard by installing onboard refueling vapor recovery (ORVR) systems on these incomplete vehicles. Since ORVR systems are based on the same carbon canister technology that manufacturers currently use to control evaporative emissions on these incomplete vehicles, we proposed to align the useful life periods for the two systems. In 40 CFR 1037.103(f), we are finalizing a useful life of 15 years or 150,000 miles, whichever comes first, for refueling standards for incomplete vehicles above 14,000 lb GVWR, as proposed.

Evaporative emission control systems are currently part of the fuel system of incomplete vehicles, and manufacturers are meeting applicable standards and useful life requirements for evaporative systems today. ORVR is a mature technology that has been installed on complete vehicles for many years, and incomplete vehicle manufacturers have experience with ORVR systems through their complete vehicle applications. Considering the manufacturers' experience with evaporative emission

standards for incomplete vehicles, and their familiarity with ORVR systems, we continue to believe it would be feasible for manufacturers to apply the same evaporative emission standard useful life periods to refueling standards. We received no adverse comments relating to the proposed 15 years/150,000 miles useful life for refueling standards, and several manufacturers commented in support of our proposed periods.

## B. Ensuring Long-Term In-Use Emissions Performance

In the proposal, we introduced several ideas for an enhanced, comprehensive strategy to ensure in-use emissions performance over more of an engine's operational life. In this section, we discuss the final provisions to lengthen emission-related warranty periods, update maintenance requirements, and improve serviceability in this rule. Taken together, these updates are intended to increase the likelihood that engine emission controls will be maintained properly through more of the service life of heavy-duty engines and vehicles, including beyond useful life.

### 1. Emission-Related Warranty

The emission-related warranty period is the period over which CAA section 207 requires an engine manufacturer to warrant to a purchaser that the engine is designed, built, and equipped so as to conform with applicable regulations under CAA section 202 and is free from defects in materials or workmanship which would cause the engine not to conform with applicable regulations for the warranty period. If an emission-related component fails during the regulatory emission warranty period, the manufacturer is required to pay for the cost of repair or replacement. A manufacturer's general emissions warranty responsibilities are currently set out in 40 CFR 1068.115. Note that while an emission warranty provides protection to the owner against emission-related repair costs during the warranty period, the owner is responsible for properly maintaining the engine (40 CFR 1068.110(e)), and the manufacturer may deny warranty claims for failures that have been caused by the owner's or operator's improper maintenance or use (40 CFR 1068.115(a)).

In this section, we present the updated emission-related warranty periods we are finalizing for heavy-duty highway engines and vehicles included in this rule. As described in Section G.10 of this preamble, we are not finalizing the proposed allowance for manufacturers to generate NO<sub>x</sub>

emissions credits from heavy-duty zero emissions vehicles (ZEVs) or the associated warranty requirements.

### i. Final Warranty Periods by Primary Intended Service Class

We are updating and significantly strengthening our emission-related warranty periods for model year 2027 and later heavy-duty engines.<sup>320</sup> We are finalizing most of the emission-related warranty provisions of 40 CFR 1036.120 as proposed. Following our approach for useful life, we are revising the proposed warranty periods for each primary intended service class to reflect the difference in average operational life of each class and after considering additional information provided by commenters. See section 4 of the Response to Comments document for our detailed responses, including descriptions of revisions to the proposed regulatory text in response to commenter requests for clarification.

EPA's current emissions-related warranty periods for heavy-duty engines range from 22 percent to 54 percent of the current regulatory useful life; the warranty periods have not changed since 1983 even as the useful life periods were lengthened.<sup>321</sup> The revised warranty periods are expected to result in better engine maintenance and less tampering, which would help to maintain the benefits of the emission controls. In addition, longer regulatory warranty periods may lead engine manufacturers to simplify repair processes and make them more aware of system defects that need to be tracked and reported to EPA.

Our final emission-related warranty periods for heavy-duty engines are presented in Table IV-2 and specified in a new 40 CFR 1036.120.<sup>322 323</sup> The final warranty mileages that apply starting in MY 2027 for Spark-ignition HDE, Light HDE, and Medium HDE match the longest warranty mileages proposed (*i.e.*, MY 2031 step of proposed Option 1) for these primary intended service

<sup>320</sup> Emission-related components for only criteria pollutant emissions or both greenhouse gas (*i.e.*, CO<sub>2</sub>, N<sub>2</sub>O, and CH<sub>4</sub>) and criteria pollutant emissions would be subject to the final warranty periods of 40 CFR 1036.120. See 40 CFR 1036.150(w).

<sup>321</sup> The useful life for heavy heavy-duty engines was increased from 290,000 miles to 435,000 miles for 2004 and later model years (62 FR 54694, October 21, 1997).

<sup>322</sup> All engines covered by a primary intended service class would be subject to the corresponding warranty period, regardless of fuel used.

<sup>323</sup> We are migrating the current alternate standards for engines used in certain specialty vehicles from 40 CFR 86.007-11 and 86.008-10 into 40 CFR 1036.605 without modifying those alternate standards, as proposed. See Section XI.B of this preamble for a discussion of these standards.

classes. For Heavy HDE, the final warranty mileage matches the longest warranty mileage proposed for MY 2027 (*i.e.*, MY 2027 step of proposed Option 1). We are also increasing the years-based warranty from the current 5 years to 10 years for all engine classes. After

considering comments, we are also adding hours-based warranty values to all primary intended service classes based on a 20 mile per hour speed threshold and the corresponding final mileage values. Consistent with current warranty provisions, the warranty

period would be whichever warranty value (*i.e.*, mileage, hours, or years) occurs first. We summarize key comments in Section IV.B.1.i.a, and provide complete responses to warranty comments in section 4 of the Response to Comments document.

TABLE IV–2—FINAL EMISSION-RELATED WARRANTY PERIODS BY PRIMARY INTENDED SERVICE CLASS

Primary intended service class	Current			Model year 2027 and later		
	Mileage	Years	Hours	Mileage	Years	Hours
Spark-Ignition HDE .....	50,000	5	.....	160,000	10	8,000
Light HDE .....	50,000	5	.....	210,000	10	10,000
Medium HDE .....	100,000	5	.....	280,000	10	14,000
Heavy HDE .....	100,000	5	.....	450,000	10	22,000

We note that we are finalizing as proposed that when a manufacturer’s certified configuration includes hybrid system components (*e.g.*, batteries, electric motors, and inverters), those components are considered emission-related components, which would be covered under the warranty requirements in new 40 CFR 1036.120.<sup>324</sup> Similar to the approach for useful life in Section IV.A, a manufacturer certifying a hybrid engine or hybrid powertrain would declare a primary intended service class for the engine family and apply the corresponding warranty periods in 40 CFR 1036.120 when certifying the engine configuration.<sup>325</sup> This approach to clarify that hybrid components are part of the broader engine configuration provides vehicle owners and operators with consistent warranty coverage based on the intended vehicle application.

We estimated the emissions impacts of the final warranty periods in our inventory analysis, which is summarized in Section VI and discussed in detail in Chapter 5 of our RIA. In Section V, we estimate costs associated with the final warranty periods, including indirect costs for manufacturers and operating costs for owners and operators.

a. Summary of the Emission-Related Warranty Proposal

In the proposal, we included several justifications for lengthened warranty periods that continue to apply for the

final provisions. First, we expected longer emission-related warranty periods would lead owners to continue maintain their engines and vehicles over a longer period of time and ensure longer-term benefits of emission controls.<sup>326</sup> Since emission-related repairs would be covered by manufacturers for a longer period of time, an owner would be more likely to have systems repaired and less likely to tamper to avoid the cost of a repair.<sup>327</sup>

Second, emission-related repair processes may get more attention from manufacturers if they are responsible for repairs over a longer period of time. The current, relatively short warranty periods provide little incentive for manufacturers to evaluate the complexity of their repair processes, since the owner pays for the repairs after the warranty period ends. As manufacturers try to remain competitive, longer emission warranty periods may lead manufacturers to simplify repair processes and provide better training to technicians in an effort to reduce their warranty repair costs. Simplifying repair processes could include modifying emission control components in terms of how systems are serviced and how components are replaced (*e.g.*, modular sub-assemblies that could be replaced individually, resulting in a quicker, less expensive repair). Improved technician training may also reduce warranty repair costs by improving identification and diagnosing component failures more

quickly and accurately, thus reducing downtime for owners and avoiding repeated failures, misdiagnoses of failures, and higher costs from repeat repair events at service facilities.

Finally, longer regulatory emission warranty periods would increase the period over which the engine manufacturer would be made aware of emission-related defects. Manufacturers are currently required to track and report defects to the Agency under the defect reporting provisions of 40 CFR part 1068. Under 40 CFR 1068.501(b), manufacturers investigate possible defects whenever a warranty claim is submitted for a component. Therefore, manufacturers can easily monitor defect information from dealers and repair shops who are performing those warranty repair services, but after the warranty period ends, the manufacturer would not necessarily know about these events, since repair facilities are less likely to be in contact with the manufacturers and they are less likely to use OEM parts. A longer warranty period would allow manufacturers to have access to better defect information over a period of time more consistent with engine useful life.

In the proposal, we also highlighted that a longer warranty period would encourage owners of vehicles powered by SI engines (as for CI engines) to follow manufacturer-prescribed maintenance procedures for a longer period of time, as failure to do so would void the warranty. We noted that the impact of a longer emissions warranty period may be slightly different for SI engines from a tampering perspective. Spark-ignition engine systems rely on mature technologies, including evaporative emission systems and three-way catalyst-based emission controls, that have been consistently reliable for light-duty and heavy-duty vehicle

<sup>324</sup> See our new definition of “emission-related component” in 40 CFR 1036.801. Defects or failures of hybrid system components can result in the engine operating more, and thus increase emissions.

<sup>325</sup> As described in 40 CFR 1036.140, the primary intended service classes are partially based on the GVWR of the vehicle in which the configuration is intended to be used. See also the update to definition of “engine configuration” in 40 CFR 1036.801 to clarify that an engine configuration would include hybrid components if it is certified as a hybrid engine or hybrid powertrain.

<sup>326</sup> See Chapter 5 of the RIA for a discussion of mal-maintenance and tampering effects in our emission inventory estimates.

<sup>327</sup> Existing warranty provisions specify that owners are responsible for properly maintaining their engines (40 CFR 1068.110(e)) and manufacturers may deny warranty claims for failures that have been caused by the owner’s or operator’s improper maintenance or use (40 CFR 1068.115(a)). See Section IV.B.2 for a description of updates to the allowable maintenance provisions.

owners.<sup>328</sup> SI engine owners may not currently be motivated to tamper with their catalyst systems to avoid repairs, but they may purchase defeat devices intended to disable emission controls to boost the performance of their engines. We expected SI engine owners may be less inclined to install such defeat devices during a longer warranty period.

We proposed two options that generally represented the range of revised emission warranty periods we considered adopting in the final rule. Proposed Option 1 included warranty periods that aligned with the MY 2027 and MY 2031 periods of the CARB HD Omnibus program and were close to 80 percent of useful life. At the time of the proposal, we assumed most manufacturers would continue to certify 50-state compliant engines in MY 2027 and later, and it would simplify the certification process if there would be consistency between CARB and Federal requirements. The warranty periods of proposed Option 2 were proposed to apply in a single step beginning in model year 2027 and to match CARB's Step 1 warranty periods for engines sold in California.<sup>329</sup> The proposed Option 2 mileages covered 40 to 55 percent of the proposed Option 1 MY 2031 useful life mileages and represented an appropriate lower end of the range of the revised regulatory emission warranty periods we considered.

While we noted that a majority of engines would reach the warranty mileage in a reasonable amount of time, some applications may have very low annual mileage due to infrequent use or low speed operation and may not reach the warranty mileage for many years. To ensure manufacturers are not indefinitely responsible for components covered under emissions warranty in these situations, we proposed to revise the years-based warranty periods and proposed hours-based warranty periods for all engine classes in proposed Option 1.

For the years-based period, which would likely be reached first by engines with lower annual mileage due to infrequent use, we proposed to increase the current period from 5 years to 7 years for MY 2027 through 2030, and to

<sup>328</sup> The last U.S. EPA enforcement action against a manufacturer for three-way catalysts was settled with DaimlerChrysler Corporation Settlement on December 21, 2005. Available online: <https://www.epa.gov/enforcement/daimlerchrysler-corporation-settlement>.

<sup>329</sup> Since the CARB Step 1 warranty program did not include updates to warranty for SI engines, the proposed Option 2 warranty mileage for that the Spark-ignition HDE class matched the current useful life for those engines, consistent with the approach for Light HDE proposed Option 2 warranty.

10 years starting with MY 2031. We also proposed to add an hours-based warranty period to cover engines that operate at low speed and/or are frequently in idle mode.<sup>330</sup> In contrast to infrequent use, low speed and frequent idle operation can strain emission control components. We proposed an hours-based warranty period to allow manufacturers to factor gradually-accumulated work into their warranty obligations.

#### b. Basis for the Final Emission-Related Warranty Periods

As detailed in section 4 of the Response to Comments document for this rule, commenter support for lengthening emission-related warranty periods varied. Many commenters expressed general support for our proposal to lengthen warranty periods in this rulemaking. Several commenters expressed specific support for the warranty periods of proposed Option 1 or proposed Option 2. Other commenters recommended EPA revise the proposal to either lengthen or shorten the warranty periods to values outside of the range of our proposed options.

Our final warranty periods continue to be influenced by the potential beneficial outcomes of lengthening emission-related warranty periods that we discussed in the proposal. Specifically, we continue to believe lengthened warranty periods will effectively assure owners properly maintain and repair their emission controls over a longer period, reduce the likelihood of tampering, provide additional information on failure modes, and create a greater incentive for manufacturers to simplify repair processes to reduce costs. Several commenters agreed with our list of potential outcomes, with some noting that any associated emissions benefits would be accelerated by pulling ahead the warranty periods of the MY 2031 step of proposed Option 1 to begin in MY 2027.

Organizations submitting adverse comments on lengthening warranty periods focused mostly the warranty mileages proposed for the Heavy HDE service class. Technology suppliers and engine manufacturers expressed concern with the lack of data from engines at high mileages, including uncertainties related to frequency and cause of failures, varying vehicle applications, and operational changes as

<sup>330</sup> We proposed warranty hours for all primary intended service classes based on a 20 mile per hour average vehicle speed threshold to convert from the proposed mileage values.

the engine ages. We considered commenters' concerns regarding how uncertainties for the highest mileages of proposed Option 1 could cause manufacturers to respond by conservatively estimating their warranty cost. We continue to expect, as noted in the proposal, that manufacturers are likely to recoup the costs of warranty by increasing the purchase price of their products. We agree with comments indicating that increases in purchase price can increase the risk of pre-buy or low-buy, especially for the heaviest engine class, Heavy HDE.

As described in this section, the final warranty periods are within the range of periods over which we expect manufacturers have access to failure data, which should limit the need for manufacturers to conservatively estimate warranty costs. We summarize our updated cost and economic impact analyses, which reflect the final warranty periods, in Sections V and X of this preamble, respectively. For more information, see our complete assessments of costs in Chapter 7 and economic impacts in Chapter 10 of the Regulatory Impact Analysis for this final rule.

We retain our proposed objectives to lengthen warranty periods to cover a larger portion of the operational lives and to be more consistent with the final useful life periods. Similar to our approach for the useful life mileages in this final rule (see Section IV.A of this preamble), we believe it is appropriate to pull ahead the longest proposed MY 2031 warranty periods to apply in MY 2027 for the smaller engine classes. For Spark-ignition HDE, Light HDE, and Medium HDE, the final warranty mileages are 160,000 miles, 210,000 miles, and 280,000 miles, respectively, which cover about 80 percent of the corresponding final useful life mileages. In response to commenters concerned with data limitations, we expect any component failure and wear data available from engines in the largest engine class would be applicable to the smaller engine classes. As such, manufacturers and suppliers have access to failure and wear data at the mileages we are finalizing for the smaller engine classes through their current R&D and in-use programs evaluating components for larger engines that currently have a 435,000 mile useful life.

We are not applying the same pull-ahead approach for the Heavy HDE warranty mileage. We do not believe it is appropriate at this time to finalize a 600,000-mile warranty for the Heavy HDE class that would uniquely cover greater than 90 percent of the 650,000-

mile final useful life, especially considering the comments pointing to uncertainties, lack of data, and potential high costs specific to Heavy HDE. We are also not applying the approach of adopting the warranty mileage of proposed Option 2, as was done for Heavy HDE useful life, as we do not believe the proposed Option 2 warranty of 350,000 miles would provide emission control assurance over a sufficient portion of the useful life. Instead, we are finalizing a warranty mileage that matches the longest mileage proposed for MY 2027 (450,000 miles), covering a percentage of the final useful life that is more consistent with the warranty periods of the smaller engine classes. The final warranty mileage for Heavy HDE is only 15,000 miles longer than the current useful life for this engine class. As noted for the warranties of the smaller engine classes, we expect manufacturers and suppliers have access to failure data nearing 450,000 miles through their R&D programs evaluating Heavy HDE over their current useful life. We expect manufacturers also have experience with their engines at this mileage through their extended warranty offerings; thus, they already possess real world operational data in addition to their internal evaluations.<sup>331</sup>

Several organizations commented on the proposed years or hours criteria for warranty. One supplier noted that analyses focused on tractors and their relatively high mileages may not accurately predict the use of vocational vehicles that are more limited by hours of operation. The same supplier suggested EPA should further differentiate warranties by vehicle classes and vocations. Another organization cautioned against warranty periods that are one-size-fits-all. Two organizations supported applying an hours-based warranty period for all engine classes to cover lower-speed applications and the 20-mph conversion factor that we proposed.

We agree that vocational vehicles have distinct use patterns; however, we did not propose and are not finalizing warranty periods at the vehicle level to distinguish between vehicle types in this rule. We are finalizing three warranty thresholds for each heavy-duty engine class: A mileage threshold that is likely to be reached first by vehicles driving many miles annually, a years threshold that is likely to be reached first by vehicles that drive infrequently

or seasonally, and an hours threshold that is likely to be reached first by vehicles that drive frequently at lower speeds or with significant idling. We believe adding an hours threshold in the final rule to the mileage- and years-based warranty periods for all engine classes will lead to more equitable warranty obligations across the range of possible vehicle applications for which a heavy-duty engine may be used.

#### ii. Warranty for Incomplete Vehicle Refueling Emission Controls

As noted in Section III.E, we are finalizing refueling emission standards for Spark-ignition HDE that are certified as incomplete vehicles above 14,000 lb GVWR.<sup>332</sup> Our refueling standards are equivalent to the refueling standards that are in effect for light- and heavy-duty complete Spark-ignition HDVs. We project manufacturers would meet the new refueling standards by adapting the existing onboard refueling vapor recovery (ORVR) systems from systems designed for complete vehicles. The new ORVR systems will likely supplement existing evaporative emission control systems installed on these vehicles.

We are finalizing warranty periods for the ORVR systems of incomplete vehicles above 14,000 lb GVWR that align with the current warranty periods for the evaporative systems on those vehicles. Specifically, warranty periods for refueling emission controls would be 5 years or 50,000 miles on incomplete Light HDV, and 5 years or 100,000 miles on incomplete Medium HDV and Heavy HDV, as proposed. See our final updates to 40 CFR 1037.120. Our approach to apply the existing warranty periods for evaporative emission control systems to the ORVR systems is similar to our approach to the final regulatory useful life periods associated with our final refueling standards discussed in Section IV.A. We received no adverse comments on our proposed warranty periods for refueling emission controls.

#### 2. Maintenance

In this section, we describe the migrated and updated maintenance provisions we are finalizing for heavy-duty highway engines. Section IV.F of this preamble summarizes the current durability demonstration requirements and our final updates.

Our final maintenance provisions, in a new section 40 CFR 1036.125, combine and amend the existing criteria pollutant maintenance provisions from 40 CFR 86.004–25 and 86.010–38. Similar to other part 1036 sections we

are adding in this rule, the structure of the new 40 CFR 1036.125 is consistent with the maintenance sections in the standard-setting parts of other sectors (e.g., nonroad compression-ignition engines in 40 CFR 1039.125). In 40 CFR 1036.205(i), we are codifying the current manufacturer practice of including maintenance instructions in their application for certification such that approval of those instructions would be part of a manufacturer's certification process.<sup>333</sup> We are also finalizing a new paragraph 40 CFR 1036.125(h) outlining several owner's manual requirements, including migrated and updated provisions from 40 CFR 86.010–38(a).

This section summarizes the final provisions that clarify the types of maintenance, update the options for demonstrating critical emission-related maintenance will occur and the minimum scheduled maintenance intervals for certain components, and specify the requirements for maintenance instructions. The proposed rule provided an extensive discussion of the rationale and information supporting the proposed maintenance provisions (87 FR 17520, March 28, 2022). See also section 6 of the Response to Comments for a detailed discussion of the comments and how they may have informed changes we are making to the proposal in this final rule.

#### i. Types of Maintenance

The new 40 CFR 1036.125 clarifies that maintenance includes any inspection, adjustment, cleaning, repair, or replacement of components and, consistent with 40 CFR 86.004–25(a)(2), broadly classifies maintenance as emission-related or non-emission-related and scheduled or unscheduled.<sup>334</sup> As proposed, we are finalizing five types of maintenance that manufacturers may choose to schedule: Critical emission-related maintenance, recommended additional maintenance, special maintenance, noncritical emission-related maintenance, and non-emission-related maintenance. As we explained in the proposal, identifying and defining these maintenance categories in final 40 CFR 1036.125 distinguishes between the types of maintenance manufacturers may choose to recommend to owners in

<sup>333</sup> The current submission of maintenance instructions provisions in 40 CFR 86.079–39 are migrated into the requirements for an application for certification provisions in 40 CFR 1036.205.

<sup>334</sup> We include repairs as a part of maintenance because proper maintenance would require owners to repair failed or malfunctioning components. We note that repairs are considered unscheduled maintenance that would not be performed during durability testing and may be covered under warranty.

<sup>331</sup> Brakora, Jessica. Memorandum to docket EPA–HQ–OAR–2019–0055. “Example Extended Warranty Packages for Heavy-duty Engines”. September 29, 2022.

<sup>332</sup> See the final updates to 40 CFR 1037.103.

maintenance instructions, identifies the requirements that apply to maintenance performed during certification durability demonstrations, and clarifies the relationship between the different types of maintenance, emissions warranty requirements, and in-use testing requirements. The final provisions thus also specify the conditions for scheduling each of these five maintenance categories.

We summarize several revisions to the proposed critical emission-related maintenance provisions in Section 0 with additional details in section 6 of the Response to Comments document. As proposed, the four other types of maintenance will require varying levels of EPA approval. In 40 CFR 1036.125(b), we propose to define recommended additional maintenance as maintenance that manufacturers recommend owners perform for critical emission-related components in addition to what is approved for those components under 40 CFR 1036.125(a). We are finalizing this provision as proposed except for a clarification in wording to connect additional recommended maintenance and critical emission-related maintenance more clearly. Under the final provisions, a manufacturer may recommend that owners replace a critical emission-related component at a shorter interval than the manufacturer received approval to schedule for critical emission-related maintenance; however, the manufacturer will have to clearly distinguish their recommended intervals from the critical emission-related scheduled maintenance in their maintenance instructions. As described in this Section III.B.2 and the proposal, recommended additional maintenance is not performed in the durability demonstration and cannot be used to deny a warranty claim, so manufacturers will not be limited by the minimum maintenance intervals or need the same approval from EPA by demonstrating the maintenance would occur.

In 40 CFR 1036.125(c), we proposed that special maintenance would be more frequent maintenance approved at shorter intervals to address special situations, such as atypical engine operation. We received one comment requesting we clarify special maintenance in proposed 40 CFR 1036.125(c) and we are finalizing this provision as proposed except that we are including an example of biodiesel use in the final paragraph (c). Under the final provisions, manufacturers will clearly state that the maintenance is associated with a special situation in the maintenance instructions provided to EPA and owners.

In 40 CFR 1036.125(d), as proposed, we are finalizing that noncritical emission-related maintenance includes inspections and maintenance that is performed on emission-related components but is considered “noncritical” because emission control will be unaffected (consistent with existing 40 CFR 86.010–38(d)). Under this final provision, manufacturers may recommend noncritical emission-related inspections and maintenance in their maintenance instructions if they clearly state that it is not required to maintain the emissions warranty.

In 40 CFR 1036.125(e), we are updating the paragraph heading from nonemission-related maintenance to maintenance that is not emission-related to be consistent with other sectors. The final provision, as proposed, describes the maintenance as unrelated to emission controls (e.g., oil changes) and states that manufacturers’ maintenance instructions can include any amount of maintenance unrelated to emission controls that is needed for proper functioning of the engine.

#### Critical Emission-Related Components

Consistent with the existing and proposed maintenance provisions, the final provisions continue to distinguish certain components as critical emission-related components. The proposal did not migrate the specific list of components defined as “critical emission-related components” from 40 CFR 86.004–25(b)(6)(i); instead, we proposed and are finalizing that manufacturers identify their specific critical components by obtaining EPA’s approval for critical emission-related maintenance using 40 CFR 1036.125(a). Separately, we also proposed a new definition for critical emission-related components in 40 CFR 1068.30 and are finalizing with revision. The final definition is consistent with paragraph 40 CFR 86.004–25(b)(6)(i)(I) and the current paragraph IV of 40 CFR part 1068, appendix A, as proposed.<sup>335</sup> We are removing the proposed reference to 40 CFR 1068, appendix A, in the final definition, since appendix A specifies emission-related components more

<sup>335</sup> Paragraph (b)(6)(i)(I) concludes the list of critical emission-related components in 40 CFR 86.004–25 with a general description stating: “Any other component whose primary purpose is to reduce emissions or whose failure would commonly increase emissions of any regulated pollutant without significantly degrading engine performance.” The existing paragraph (IV) of 40 CFR 1068, appendix A similarly states: “Emission-related components also include any other part whose primary purpose is to reduce emissions or whose failure would commonly increase emissions without significantly degrading engine/equipment performance.”

generally. To avoid having similar text in two locations, we are also replacing the current text of paragraph IV of 40 CFR 1068, appendix A, with a reference to the new part 1068 definition of critical emission-related components.

#### ii. Critical Emission-Related Maintenance

A primary focus of the final maintenance provisions is critical emission-related maintenance. Critical emission-related maintenance includes any adjustment, cleaning, repair, or replacement of emission-related components that manufacturers identify as having a critical role in the emission control of their engines. The final 40 CFR 1036.125(a), consistent with current maintenance provisions in 40 CFR part 86 and the proposal, will continue to allow manufacturers to seek advance approval from EPA for new emission-related maintenance they wish to include in maintenance instructions and perform during durability demonstration. The final 40 CFR 1036.125(a) retains the same proposed structure that includes a maintenance demonstration and minimum maintenance intervals, and a pathway for new technology that may be applied in engines after model year 2020.

We are finalizing with revision the maintenance demonstration proposed in 40 CFR 1036.125(a)(1). The final provision includes the five proposed options for manufacturers to demonstrate the maintenance is reasonably likely to be performed in-use, with several clarifying edits detailed in the Response to Comments document.<sup>336</sup> As further discussed in Section IV.D, we are finalizing the separate statement in 40 CFR 1036.125(a)(1) that points to the final inducement provisions, noting that we will accept DEF replenishment as reasonably likely to occur if an engine meets the specifications in proposed 40 CFR 1036.111; we are not setting a minimum maintenance interval for DEF replenishment. Also, as noted in the proposal and reiterated here, the first maintenance demonstration option, described in 40 CFR 1036.125(a)(1)(i), is intended to cover emission control technologies that have an inherent performance degradation that coincides with emission increases, such as back pressure resulting from a clogged DPf.

Consistent with the current and proposed maintenance provisions, we are specifying minimum maintenance

<sup>336</sup> The five maintenance demonstration options are consistent with current maintenance demonstration requirements in 40 CFR 86.004–25 and 86.094–25.

intervals for certain emission-related components, such that manufacturers may not schedule more frequent maintenance than we allow. In 40 CFR 1036.125(a)(2), we are updating the list of components with minimum maintenance intervals to more accurately reflect components in use today and extending the replacement intervals such that they reflect replacement intervals currently scheduled for those components. See the NPRM preamble for a discussion of our justification for terminology changes we are applying in the final rule, and the list of components that we are not migrating from 40 CFR part 86 because they are obsolete or covered by other parts.

Consistent with current maintenance provisions, we proposed to disallow replacement of catalyst beds and particulate filter elements within the regulatory useful life of the engine.<sup>337</sup> We are removing reference to catalyst beds and particulate filter elements in the introductory text of paragraph (a)(2) and instead are adding them, with updated terminology, as a separate line in the list of components in Table 1 of 40 CFR 1036.125(a)(2) with minimum maintenance intervals matching the final useful life values of this rule.<sup>338</sup> Including catalyst substrates and particulate filter substrates directly in the table of minimum maintenance intervals more clearly connects the intervals to the useful life values. In response to manufacturer comments requesting clarification, we are also adding a reference to 40 CFR 1036.125(g) in paragraph (a)(2) to clarify

that manufacturers are not restricted from scheduling maintenance more frequent than the minimum intervals, including replacement of catalyst substrates and particulate filter substrates, if they pay for it.

We are finalizing as proposed the addition of minimum intervals for replacing hybrid system components in engine configurations certified as hybrid engines or hybrid powertrains, which would include the rechargeable energy storage system (RESS). Our final minimum intervals for hybrid system components equal the current useful life for the primary intended service classes of the engines that these electric power systems are intended to supplement or replace.<sup>339</sup>

Table IV–3 summarizes the minimum replacement intervals we are finalizing in a new table in 40 CFR 1036.125(a)(2). As explained in the proposal, we believe it is appropriate to account for replacement intervals that manufacturers have already identified and demonstrated will occur for these components and the final replacement intervals generally match the shortest mileage interval (*i.e.*, most frequent maintenance) of the published values, with some adjustments after considering comments. Commenters noted that some sensors are not integrated with a listed system and requested EPA retain a discrete set of minimum intervals for sensors, actuators, and related ECMs. We agree and are specifying minimum intervals that match the current intervals for sensors, actuators, and related control modules that are not integrated into other systems. We are retaining the proposed text to indicate

that intervals specified for a given system would apply for all to actuators, sensors, tubing, valves, and wiring associated with that component associated with that system. We are also revising the minimum intervals for ignition wires from the proposed 100,000 miles to 50,000 miles to match the current intervals and adding an interval for ignition coils at the same 50,000 miles after considering comments. See section 6 of the Response to Comments document for other comments we considered when developing the final maintenance provisions.

We proposed to retain the maintenance intervals specified in 40 CFR 86.004–25 for adjusting or cleaning components as part of critical emission-related maintenance. We are finalizing the proposed maintenance intervals for adjusting and cleaning with one correction. Commenters noted that the proposal omitted an initial minimum interval for adjusting or cleaning EGR system components. Consistent with 40 CFR 86.004–25(b), we are correcting the proposed intervals for several components (catalyst system components, EGR system components (other than filters or coolers), particulate filtration system components, and turbochargers) from 150,000 miles or 4,500 hours to include an initial interval of 100,000 miles or 3,000 hours, with subsequent intervals of 150,000 miles or 4,500 hours. We did not reproduce the new Table 2 from 40 CFR 1036.125(a)(2) showing the minimum intervals for adjusting or cleaning components in this preamble.

TABLE IV–3—MINIMUM SCHEDULED MAINTENANCE INTERVALS IN MILES (OR HOURS) FOR REPLACING CRITICAL EMISSION-RELATED COMPONENTS IN 40 CR 1036.125

Components	Spark-ignition HDE	Light HDE	Medium HDE	Heavy HDE
Spark plugs .....	25,000 (750)	.....	.....	.....
DEF filters .....	.....	100,000 (3,000)	100,000 (3,000)	100,000 (3,000)
Crankcase ventilation valves and filters .....	60,000 (1,800)	60,000 (1,800)	60,000 (1,800)	60,000 (1,800)
Ignition wires and coils .....	50,000 (1,500)	.....	.....	.....
Oxygen sensors .....	80,000 (2,400)	.....	.....	.....
Air injection system components .....	110,000 (3,300)	.....	.....	.....
Sensors, actuators, and related control modules that are not integrated into other systems .....	100,000 (3,000)	100,000 (3,000)	150,000 (4,500)	150,000 (4,500)
Particulate filtration systems (other than filter substrates) .....	100,000 (3,000)	100,000 (3,000)	250,000 (7,500)	250,000 (7,500)
Catalyst systems (other than catalyst substrates), fuel injectors, electronic control modules, hybrid system components, turbochargers, and EGR system components (including filters and coolers) .....	110,000 (3,300)	110,000 (3,300)	185,000 (5,550)	435,000 (13,050)
Catalyst substrates and particulate filter substrates .....	200,000 (10,000)	270,000 (13,000)	350,000 (17,000)	650,000 (32,000)

<sup>337</sup> Existing 40 CFR 86.004–25(b)(4)(iii) states that only adjustment and cleaning are allowed for catalyst beds and particulate filter elements and that replacement is not allowed during the useful life. Existing 40 CFR 86.004 25(i) clarifies that these components could be replaced or repaired if

manufacturers demonstrate the maintenance will occur and the manufacturer pays for it.

<sup>338</sup> In the final provision, we replaced “catalyst bed” with “catalyst substrate” and “particulate filter element” with “particulate filter substrate”.

<sup>339</sup> We note that Table IV–3 and the corresponding Table 1 of 40 CFR 1036.125(a)(2) include a reference to “hybrid system components”, which we inadvertently omitted from the tables in the proposed rule.



We received no adverse comments on the proposed approach to calculate the corresponding hours values for each minimum maintenance interval. Consistent with our current maintenance provisions and the proposal, we are finalizing minimum hours values based on the final mileage and a 33 miles per hour vehicle speed (e.g., 150,000 miles would equate to 4,500 hours).<sup>340</sup> Consistent with the current maintenance intervals specified in part 86 and the proposal, we are not including year-based minimum intervals; OEMs can use good engineering judgment if they choose to include a scheduled maintenance interval based on years in their owner's manuals.

For new technology, not used on engines before model year 2020, we are providing a process for manufacturers to seek approval for new scheduled maintenance, consistent with the current maintenance provisions. We received no adverse comment on the proposal to migrate 40 CFR 86.094–25(b)(7)(ii), which specifies a process for approval of new critical emission-related maintenance associated with new technology, and 40 CFR 86.094–25(b)(7)(iii), which allows manufacturers to ask for a hearing if they object to our decision.<sup>341</sup> We are finalizing a new 40 CFR 1036.125(a)(3), as proposed.

### iii. Source of Parts and Repairs

Consistent with CAA section 207<sup>342</sup> and our existing regulations for heavy duty vehicles under part 1037, we proposed a new paragraph 40 CFR 1036.125(f) to clarify that manufacturers' written instructions for proper maintenance and use, discussed further in Section IV.B.2.vi, generally cannot limit the source of parts and service owners use for maintenance unless the component or service is provided without charge under the purchase agreement, with two specified exceptions.<sup>343</sup> We are moving, with revisions, the content of the proposed paragraph (f) to 40 CFR 1036.125(h)(2). See section 6 of the Response to

<sup>340</sup> The minimum hours-based intervals for catalyst substrates and particulate filter substrates match the useful life hours that apply for each primary intended service class to ensure these components are not replaced within the regulatory useful life of the engine, consistent with existing maintenance provisions. The useful life hours are calculated using a 22 miles per hour conversion factor as described in Section IV.A of this preamble.

<sup>341</sup> Hearing procedures are specified in 40 CFR 1036.820 and 40 CFR part 1068, subpart G.

<sup>342</sup> See, e.g., CAA section 207(c)(3)(B) and (g).

<sup>343</sup> This provision has been adopted in the standard-setting parts of several other sectors (see 1037.125(f)).

Comments. Consistent with the proposal, we are finalizing that manufacturers cannot specify a particular brand, trade, or corporate name for components or service and cannot deny a warranty claim due to "improper maintenance" based on owners choosing not to use a franchised dealer or service facility or a specific brand of part unless the component or service is provided without charge under the purchase agreement. Consistent with current maintenance provisions and CAA section 207(c)(3)(B), a second exception is that manufacturers can specify a particular service facility and brand of parts only if the manufacturer convinces EPA during the approval process that the engine will only work properly with the identified service or component. We are not finalizing at this time the proposed 40 CFR 1036.125(f) requirement regarding specific statements on the first page of written maintenance instructions; after consideration of comments, we agree with commenters that the final regulatory text accomplishes the intent of our proposal without the additional proposed first sentence.

### iv. Payment for Scheduled Maintenance

We proposed 40 CFR 1036.125(g) to allow manufacturers to schedule maintenance not otherwise allowed by 40 CFR 1036.125(a)(2) if they pay for it. The proposed paragraph (g) also included four criteria to identify components for which we would require manufacturers to pay for any scheduled maintenance within the regulatory useful life. The four criteria, which are based on current provisions that apply for nonroad compression-ignition engines, would require manufacturers to pay for components that were not in general use on similar engines before 1980, whose primary purpose is to reduce emissions, where the cost of the scheduled maintenance is more than 2 percent of the price of the engine, and where failure to perform the scheduled maintenance would not significantly degrade engine performance.<sup>344</sup> We continue to believe that components meeting the four criteria are less likely to be maintained without the incentive of manufacturers paying for it and we are finalizing 40 CFR 1036.125(g) as proposed.

As noted in Section IV.B.2.ii, manufacturers cannot schedule replacement of catalyst substrates or particulate filter substrates within the regulatory useful life of the engine unless they pay for it. As explained in

the proposed rule, in addition to catalyst substrates and particulate filter substrates, we expect that replacement of EGR valves, EGR coolers, and RESS of certain hybrid systems also meet the 40 CFR 1036.125(g) criteria and manufacturers will only be able to schedule replacement of these components if the manufacturer pays for it.

In the proposal, we requested comment on restricting the replacement of turbochargers irrespective of the four criteria of proposed 40 CFR 1036.125(g). One commenter suggested that EPA should follow the CARB approach that requires manufacturers to pay for scheduled maintenance of turbochargers within the regulatory useful life. The comment indicated the cost of repairs and "significant impact" of a failed turbocharger on emissions justify requiring that manufacturers pay for replacement. We disagree and are not finalizing a separate requirement for turbochargers. Turbochargers are not added to engines specifically to control emissions and we expect the performance degradation associated with a failing turbocharger is likely to motivate owners to fix the problem. We continue to believe the four criteria in 40 CFR 1036.125(g) are an appropriate means of distinguishing components for which manufacturers should pay in order to ensure the components are maintained.

### v. Maintenance Instructions

As proposed, our final 40 CFR 1036.125 preserves the requirement that the manufacturer provide written instructions for properly maintaining and using the engine and emission control system, consistent with CAA section 207(c)(3)(A).<sup>345</sup> The new 40 CFR 1036.125(h) describes the information that we are requiring manufacturers to include in an owner's manual, consistent with CAA sections 202 and 207. The new 40 CFR 1036.125(h)(1) generally migrates the existing maintenance instruction provisions specified in 40 CFR 86.010–38(a). As described in Section IV.B.2.iii, final 40 CFR 1036.125(h)(2) includes revised content from proposed 40 CFR 1036.125(f). The final paragraph (h)(2) is also revised from the proposed regulatory text to clarify that EPA did not intend the proposed paragraph as a requirement for owners to maintain

<sup>345</sup> CAA section 207(c)(3)(A) states that the manufacturer shall furnish with each new motor vehicle or motor vehicle engine written instructions for the proper maintenance and use of the vehicle or engine by the ultimate purchaser and that such instructions shall correspond to regulations which the Administrator shall promulgate.

<sup>344</sup> See 40 CFR 1039.125(g).

records in order to make a warranty claim. While 40 CFR 1036.120(d) allows manufacturers to deny warranty claims for improper maintenance and use, owners have expressed concern that it is unclear what recordkeeping is needed to document proper maintenance and use, and both the proposed and final 40 CFR 1036.125(h)(2) are intended to ensure manufacturers are communicating their expectations to owners.

Consistent with the current 40 CFR 86.010–38(a)(2), our final 40 CFR 1036.125(h)(2) also requires manufacturers to describe in the owner's manual if manufacturers expect owners to maintain any documentation to show the engine and emission control system have been properly maintained and, if so, to specify what documentation. Manufacturers should be able to identify their expectations for documenting routine maintenance and repairs related to warranty claims. For instance, if a manufacturer requires a maintenance log as part of their process for reviewing warranty claims and determining whether the engine was properly maintained, we expect the owner's manual would provide an example log with a clear statement that warranty claims require an up-to-date maintenance record. We note that 40 CFR 1036.125 specifies minimum maintenance intervals for critical emission-related maintenance, and limits manufacturers from invalidating warranty if certain other types of allowable maintenance are not performed (*i.e.*, recommended additional maintenance and noncritical emission-related maintenance). Any required maintenance tasks and intervals must be consistent with the requirements and limitations in 40 CFR 1036.125. As explained at proposal, we may review a manufacturer's information describing the parameters and documentation for demonstrating proper maintenance before granting certification for an engine family.

The maintenance instructions requirements we are finalizing for the remainder of 40 CFR 1036.125(h) are covered in the serviceability discussion in Section IV.B.3 and inducements discussion in Section IV.C of this preamble. As noted in Section IV.B.3, our serviceability provisions supplement the service information provisions specified in 40 CFR 86.010–38(j).<sup>346</sup>

<sup>346</sup> We are not migrating the service information provisions into 40 CFR part 1036 in this rule.

vi. Performing Scheduled Maintenance on Test Engines

We are finalizing our proposed update to 40 CFR 1065.410(c) to clarify that inspections performed during testing include electronic monitoring of engine parameters. While we intended the proposed update to include prognostic systems, the proposed text referred only to electronic tools, and we are revising from the proposed text in the final provision to include “or internal engine systems” to clarify. Manufacturers that include prognostic systems as part of their engine packages to identify or predict malfunctioning components may use those systems during durability testing and would describe any maintenance performed as a result of those systems, consistent with 40 CFR 1065.410(d), in their application for certification. We note that, to apply these electronic monitoring systems in testing, the inspection tool (*e.g.*, prognostic system) must be readable without specialized equipment so it is available to all customers or accessible at dealerships and other service outlets consistent with CAA sections 202(m) and 206.

### 3. Serviceability

This Section IV.B.3 describes the provisions we are finalizing to improve serviceability, reduce mal-maintenance, and ensure owners are able to maintain emission control performance throughout the entire in-use life of heavy-duty engines. See section IV.B.2 of this preamble for a discussion of manufacturers' obligations to provide maintenance instructions to operators. Also see the preamble of the proposed rule for further discussion of why EPA proposed these serviceability and maintenance information provisions.<sup>347</sup> The final serviceability and maintenance information provisions were informed by comments, and we summarize key comments in this section.<sup>348</sup> We provide complete responses to the serviceability-related comments in section 5 of the Response to Comments.

#### i. Background

Without proper maintenance, the emission controls on heavy-duty

<sup>347</sup> See section IV.B.3. of the proposed preamble (87 FR 17517, March 28, 2022).

<sup>348</sup> While we requested comment on several potential approaches to improve serviceability of electric vehicles in the proposal (87 FR 17517, March 28, 2022), EPA is not taking final action on any requirements related to this request at this time; we may consider the comments provided on improved serviceability of electric vehicles in future rulemakings relevant to electric vehicles. See section 5.3 of the Response to Comments document for details on comments received.

engines may not function as intended, which can result in increased emissions. Mal-maintenance, which includes delayed or improper repairs and delayed or unperformed maintenance, can be intentional (*e.g.*, deferring repairs due to costs) or unintentional (*e.g.*, not being able to diagnose the actual problem and make the proper repair).

In the NPRM, EPA discussed stakeholder concerns with the reliability of MY 2010 and later heavy-duty engines, and significant frustration expressed by owners concerning their experiences with emission control systems on such engines. EPA explained that stakeholders have communicated to EPA that, although significant improvements have been made to emission control systems since they were first introduced into the market, reliability and serviceability continue to cause them concern. EPA received comments on the NPRM further highlighting problems from fleets, owners, and operators. Commenters noted issues with a range of emission-related components, including: Sensors (DPF and SCR-related), DEF dosers, hoses, filters, EGR valves, EGR coolers and EGR actuators, SCR catalysts, DOC, turbos, wiring, decomposition tubes, cylinder heads, and DPFs. Specifically, for example, comments included described experiences with aftertreatment wiring harness failures, DEF nozzles plugging or over-injecting, NO<sub>x</sub> sensor failures, defective DEF pumps and level sensors, systems being less reliable in rain and cold weather, more frequent required cleaning of DPFs than anticipated, and problems related to DEF build-up. See section 5 of the Response to Comment for further information and the detailed comments.

In addition to existing labeling, diagnostic, and service information requirements, EPA proposed to require important maintenance information be made available in the owner's manual as a way to improve factors that may contribute to mal-maintenance. The proposed serviceability provisions were expected to result in better service experiences for independent repair technicians, specialized repair technicians, owners who repair their own equipment, and possibly vehicle inspection and maintenance technicians. Furthermore, the proposed provisions were intended to improve owner experiences operating and maintaining heavy-duty engines and provide greater assurance of long-term in-use emission reductions by reducing the likelihood of occurrences of tampering.

Given the importance and complexity of emission control systems and the

impact to drivers for failing to maintain such systems (e.g., inducements), EPA believes it is critical to include additional information about emission control systems in the owner's manual. We proposed to require manufacturers to provide more information concerning the emission control system in the owner's manual to include descriptions of how the emissions systems operate, troubleshooting information, and diagrams. EPA has imposed similar requirements in the past, such as when EPA required vacuum hose diagrams be included on the emission label to improve serviceability and help inspection and maintenance facilities identify concerns with that system.<sup>349</sup>

#### ii. Final Maintenance Information Requirements for Improved Serviceability

EPA received both supportive and adverse comments from a number of stakeholders on the serviceability proposals (see section 5 of the Response to Comments). For example, comments from service providers and manufacturers largely objected to the proposed serviceability requirements, while owners and operators supported the proposed requirements. EPA is finalizing requirements for improved serviceability so that owners and operators can more easily understand advanced emission control system operation and identify issues in such systems as they arise during operation. To the extent EPA can ensure this information is harmonized among manufacturers, we believe this will improve the experiences of owners, operators, parts counter specialists, and repair technicians, and reduce frustration that could otherwise create an incentive to tamper.

CAA section 207(c)(3)(A) requires manufacturers to provide instructions for the proper maintenance and use of a vehicle or engine by the ultimate purchaser and requires such instructions to correspond to EPA regulations. The final rule includes maintenance provisions migrated and updated from 40 CFR part 86, subpart A, to a new 40 CFR 1036.125, that specify the maintenance instructions manufacturers must provide in an owner's manual to ensure that owners can properly maintain their vehicles (see Section IV.B.2). Additionally, as a part of the new 40 CFR 1036.125(h), we are finalizing specific maintenance information manufacturers must provide in the owner's manual to improve serviceability:

- EPA is finalizing with revision the proposed requirement for manufacturers to provide a description of how the owner can use the OBD system to troubleshoot problems and access emission-related diagnostic information and codes stored in onboard monitoring systems. The revision replaces the proposed requirement that the owner's manual include general information on how to read and understand OBD codes with a more specific set of required information. The final requirement specifies that, at a minimum, manufacturers provide a description of how to use the OBD system to troubleshoot and access information and codes, including (1) identification of the OBD communication protocol used, (2) location and type of OBD connector, (3) a brief description of what OBD is (including type of information stored, what a malfunction indicator light (MIL) is, explanation that some MILs may self-extinguish), and (4) a note that certain engine and emission data is publicly available using any scan tool, as required by EPA. As we describe further in section IV.C.1.iii, we are not taking final action on the proposed health monitors. Therefore, we are also not requiring manufacturers to provide information about the role of the health monitor to help owners service their engines before components fail in the description of the OBD system.

- EPA is finalizing as proposed, with a few clarifications in wording, a requirement for manufacturers to identify critical emission systems and components, describe how they work, and provide a general description of how the emission control systems operate.

- EPA is finalizing as proposed the requirement for manufacturers to include one or more diagrams of the engine and its emission-related components, with two exceptions: (1) We are not finalizing the proposed requirements to include the identity, location, and arrangement of wiring in the diagram, and we are not requiring information related to the expected pressures at the particulate filter and exhaust temperatures throughout the aftertreatment system. The final requirement specifies the following information is required, as proposed:

- The flow path for intake air and exhaust gas.

- The flow path of evaporative and refueling emissions for spark-ignition engines, and DEF for compression-ignition engines, as applicable.

- The flow path of engine coolant if it is part of the emission control system described in the application for certification.

- The identity, location, and arrangement of relevant emission sensors, DEF heater and other DEF delivery components, and other critical emission-related components.

- Terminology to identify components must be consistent with codes the manufacturer uses for the OBD system.

- EPA is revising the proposed requirement relating to exploded-view drawings and basic assembly requirements in the owner's manual. The final provision replaces a general reference to aftertreatment devices with a specific list of components that should be included in one or more diagrams in the owner's manual, including: EGR Valve, EGR actuator, EGR cooler, all emission sensors (e.g., NO<sub>x</sub>, soot sensors, etc.), temperature and pressure sensors (EGR, DPF, DOC, and SCR-related, including DEF-related temperature and pressure sensors), fuel (DPF-related) and DEF dosing units and components (e.g., pumps, filters, metering units, nozzles, valves, injectors), DEF quality sensors, DPF filter, DOC, SCR catalyst, aftertreatment-related control modules, any other DEF delivery-related components (e.g., lines and freeze protection components), and aftertreatment-related wiring harnesses if replaceable separately. The revision also notes that the information could be provided in multiple diagrams. We are also revising the proposed requirement to include part numbers for all components in the drawings and instead are only requiring part numbers for sensors and filters related to SCR or DPF systems. We are not finalizing at this time the broader requirement that this information include enough detail to allow a mechanic to replace any of these components. Finally, once published for a given model year, manufacturers will not be required to revise their owner's manual with updated part numbers if a part is updated in that model year. We recognize that manufacturers are able to use outdated part numbers to find updated parts.

- EPA is finalizing as proposed the requirement for manufacturers to provide a statement instructing owners or service technicians where and how to find emission recall and technical repair information available without charge from the National Highway Traffic Safety Administration.<sup>350</sup>

- EPA is finalizing with some modifications from the proposal the requirement for manufacturers to

<sup>349</sup> See 53 FR 7675, March 9, 1988, and 55 FR 7177, February 29, 1990 for more information.

<sup>350</sup> NHTSA provides this information at <https://www.nhtsa.gov/recalls>. For example, manufacturers should specify if the information would be listed under "Vehicle" or "Equipment."

include a troubleshooting guide to address SCR inducement-related and DPF regeneration-related warning signals. For the SCR system this requirement includes:

- The inducement derate schedule (including indication that DEF quantity-related inducements will be triggered prior to the DEF tank being completely empty).
- The meaning of any trouble lights that indicate specific problems (e.g., DEF level).
- A description of the three types of SCR-related derates (DEF quantity, DEF quality and tampering) and a notice that further information on the cause of (e.g., trouble codes) is available using the OBD system.

• For the DPF system the troubleshooting guide requirement includes:

- Information on the occurrence of DPF-related derates.
- EPA is finalizing in 40 CFR 1036.110(c) that certain information must be displayed on-demand for operators. Specifically, EPA is finalizing the requirement that for SCR-related inducements, information such as the derate and associated fault code must be displayed on-demand for operators (see section IV.D.3 for further information). EPA is also finalizing requirements that the number of DPF regenerations, DEF consumption rate, and the type of derate (e.g., DPF- or SCR-related) and associated fault code for other types of emission-related derates be displayed on-demand for operators (see section IV.C.1.iii for further information).

EPA proposed that manufacturers include a Quick Response (QR) code on the emission label that would direct repair technicians, owners, and inspection and maintenance facilities to a website providing critical emission systems information at no cost. We are not taking final action at this time on the proposed requirement to include QR codes on the emission control information label. After considering manufacturers' comments, we intend to engage in further outreach and analysis before adopting electronic labeling requirements, such as QR codes. In this rule, we are instead finalizing that the owner's manual must include a URL directing owners to a web location for the manufacturer's service information required in 40 CFR 86.010–38(j). We recognize the potential for electronic labels with QR codes or similar technology to provide useful information for operators, inspectors, and others. Manufacturers from multiple industry sectors are actively pursuing alternative electronic labeling. In the absence of new requirements for

electronic labeling, manufacturers must continue to meet requirements for applying physical labels to their engines. Manufacturers may include on the vehicle or engine any QR codes or other electronic labeling information that goes beyond what is required for the physical emission control information label. EPA is also not taking final action at this time on the proposed requirement to include a basic wiring diagram for aftertreatment-related components in the owner's manual. Finally, EPA is not taking final action at this time on requirements related to DPF cleaning; instead, EPA intends to continue to follow the work CARB has undertaken in this area and may consider taking action in a future rule.

### iii. Other Emission Controls Education Options

In addition to our proposed provisions to provide more easily accessible service information for operators, we sought comment on whether educational programs and voluntary incentives could lead to better maintenance and real-world emission benefits. We received comments in response to the NPRM supportive of improving such educational opportunities to promote an understanding of how advanced emission control technologies function and the importance of emissions controls as they relate to the broader economy and the environment (see section 5.4 of the Response to Comment for further details). EPA is not finalizing any requirements related to this request for comment at this time but will look for future opportunities to improve the availability of information on emission control systems.

### C. Onboard Diagnostics

As used here, the terms “onboard diagnostics” and “OBD” refer to systems of electronic controllers and sensors required by regulation to detect malfunctions of engines and emission controls. EPA's OBD regulations for heavy-duty engines are contained in 40 CFR 86.010–18, which were initially promulgated on February 24, 2009 (74 FR 8310). Those requirements were harmonized with CARB's OBD program then in place. Consistent with our authority under CAA section 202(m), EPA is finalizing an update to our OBD regulations in 40 CFR 1036.110 to align with existing CARB OBD requirements as appropriate, better address newer diagnostic methods and available technologies, and to streamline provisions.

### 1. Incorporation of California OBD Regulations by Reference

CARB OBD regulations for heavy-duty engines are codified in title 13, California Code of Regulations, sections 1968.2, 1968.5, 1971.1, and 1971.5. EPA is finalizing our proposal to incorporate by reference in 40 CFR 1036.810 the OBD requirements CARB adopted October 3, 2019.<sup>351</sup> <sup>352</sup> In response to the NPRM, EPA received a number of comments supportive of EPA's adoption of the revised CARB OBD program, including the 2019 rule amendments. As discussed in this section and reflected in final 40 CFR 1036.110(b), our final rule will harmonize with the majority of CARB's existing OBD regulations, as appropriate and consistent with the CAA, and make these final requirements mandatory beginning in MY 2027 and optional in earlier model years. These new requirements better address newer diagnostic methods and available technologies and have the additional benefit of being familiar to industry. For example, the new tracking requirements contained in CARB's updated OBD program, known as the Real Emissions Assessment Logging (“REAL”) program, track real-world emissions systems performance of heavy-duty engines. The REAL tracking requirements include the collection of onboard data using existing OBD sensors and other vehicle performance parameters, which will better allow the assessment of real world, in-use emission performance.

EPA's final OBD requirements are closely aligned with CARB's existing requirements with a few exceptions, as further described in Section IV.C.1.i. We are finalizing exclusions to certain provisions that are not appropriate for a Federal program and including additional elements to improve on the usefulness of OBD systems for operators.

<sup>351</sup> This CARB rulemaking became effective the same day and began to phase in under CARB's regulations with MY 2022. The CARB regulations we are adopting are available at: <https://ww2.arb.ca.gov/resources/documents/heavy-duty-obd-regulations-and-rulemaking>.

<sup>352</sup> The legal effect of incorporation by reference is that the material is treated as if it were published in the **Federal Register** and CFR. This material, like any other properly issued rule, has the force and effect of law. Congress authorized incorporation by reference in the Freedom of Information Act to reduce the volume of material published in the **Federal Register** and CFR. (See 5 U.S.C. 552(a) and 1 CFR part 51). See <https://www.archives.gov/federal-register/cfr/ibr-locations.html> for additional information.

i. CARB OBD Provisions Revised or Not Included in the Finalized Federal Program

CARB's 2019 OBD program includes some provisions that may not be appropriate for the Federal regulations.<sup>353</sup> In a new 40 CFR 1036.110(b), we are finalizing the following clarifications and changes to the 2019 CARB regulations that we are otherwise incorporating by reference:

1. Modifying the threshold

requirements contained in the 2019 CARB OBD standards we are adopting (as discussed in Section IV.C.1.ii),

2. Providing flexibilities to delay compliance up to three model years for small manufacturers who have not previously certified an engine in California,

3. Allowing good engineering judgment to correlate the CARB OBD standards with EPA OBD standards,

4. Clarifying that engines must comply with OBD requirements throughout EPA's useful life as specified in 40 CFR 1036.104, which may differ from CARB's required useful life for some model years,

5. Clarifying that the purpose and applicability statements in 13 CCR 1971.1(a) and (b) do not apply,

6. Not requiring the manufacturer self-testing and reporting requirements in 13 CCR 1971.1(l)(4) "Verification of In-Use Compliance" and 1971.5(c) "Manufacturer Self-Testing" (note, in the proposal we inadvertently cited incorrect CARB provisions for the intended referenced requirements),

7. Retaining our existing deficiency policy (which we are also migrating into 40 CFR 1036.110(d)), adjusting our deficiency timing language to match CARB's, and specifying that the deficiency provisions in 13 CCR 1971.1(k) do not apply,

8. Requiring additional freeze frame data requirements (as further explained in Section IV.C.1.iii),

9. Requiring additional data stream parameters for compression- and spark-ignition engines (as further explained in Section IV.C.1.iii), and

10. Providing flexibilities to reduce redundant demonstration testing requirements for engines certified to CARB OBD requirements.

With regard to the second through the fifth items, EPA is finalizing these requirements as proposed for the reasons stated in the proposal. For the sixth item, EPA is finalizing this

<sup>353</sup> EPA is reviewing a waiver request under CAA section 209(b) from California for the Omnibus rule; note, we are making no determination in this action about the appropriateness of these provisions for CARB's regulation.

requirement for the reasons stated in the proposal and as proposed with the exception of a correction to the CARB reference we cited.

EPA received supportive comment from manufacturers on our proposal to migrate our existing deficiency requirements, and adverse comment from manufacturers and CARB requesting that EPA harmonize with CARB's retroactive deficiency provisions. CARB's deficiency requirements are described in 13 CCR 1971.1(k) and include descriptions of requirements such as how deficiencies are granted, fines charged for deficiencies, allowable timelines, and the application of retroactive deficiencies. We are finalizing as proposed to migrate our existing approach to deficiency provisions in 40 CFR 86.010–18(n) into 40 CFR 1036.110(d).<sup>354</sup> See section 7.1 of the Response to Comments for further details on comments received and EPA's responses.

EPA also received comment concerned with EPA's regulatory language describing the allowable timeframe for deficiencies. Commenters said EPA's proposed deficiency timeline is shorter than CARB's and that EPA should harmonize with CARB and provide manufacturers with 3 years to make hardware-related changes. EPA is finalizing a change to 40 CFR 1036.110(d)(3) to ensure our language is consistent with CARB's deficiency timeline in 13 CCR 1971.1(k)(4).

EPA received supportive and adverse comment on the proposal to require additional freeze frame data requirements, including that the reference in our regulations was overly broad and possibly in error. EPA is finalizing these requirements with revisions to those proposed in 40 CFR 1036.110(b)(8) to be more targeted. It is critical for there to be sufficient emissions-related parameters captured in freeze frame data to enable proper repairs.

EPA received supportive and adverse comment on the proposal to require additional data stream parameter requirements, including comment that our regulations needed to be more specific. EPA is finalizing these requirements with revisions to those proposed in 40 CFR 1036.110(b)(9) to properly capture the additional elements we intended to add to the freeze frame and to ensure these additional parameters are interpreted properly as an expansion of the existing data stream requirements in 13 CCR 1971.1(h)(4.2). Access to important

<sup>354</sup> See 74 FR 8310, 8349 (February 24, 2009).

emissions-related data parameters is critical for prompt and proper repairs.

EPA is finalizing flexibilities to reduce redundant demonstration testing requirements for engines certified to CARB OBD requirements, see section IV.C.1.iv. of this preamble for further discussion on what we are finalizing.

It is important to emphasize that by not incorporating certain existing CARB OBD requirements (e.g., the "Manufacturer Self-Testing" requirements) into our regulations, we are not waiving our authority to require such testing on a case-by-case basis. CAA section 208 gives EPA broad authority to require manufacturers to perform testing not specified in the regulations in such circumstances. Thus, should we determine in the future that such testing is needed, we would retain the authority to require it pursuant to CAA section 208.

ii. OBD Threshold Requirements

a. Malfunction Criteria Thresholds

Existing OBD requirements specify how OBD systems must monitor certain components and indicate a malfunction prior to when emissions would exceed emission standards by a certain amount, known as an emission threshold. Emission thresholds for these components under the existing requirements in the 2019 CARB OBD update that we are incorporating by reference are generally either an additive or multiplicative value above the applicable exhaust emission standard. EPA proposed to modify the threshold requirements in the 2019 CARB OBD update to be consistent with the provisions finalized by CARB in their Omnibus rule in December of 2021 and not tighten threshold requirements while finalizing lower emission standards.<sup>355 356</sup> This meant, for example, that for monitors required to detect a malfunction before NO<sub>x</sub> emissions exceed 1.75 times the applicable existing NO<sub>x</sub> standard, the manufacturer would continue to use the same numeric threshold (e.g., 0.35 g/bhp-hr NO<sub>x</sub>) for the new emission standards finalized in this rule.

EPA received comments from manufacturers and operators in support

<sup>355</sup> California Air Resources Board. Staff Report: Addendum to the Final Statement of Reasons for Rulemaking—Public Hearing to Consider the Proposed Heavy-Duty Engine and Vehicle Omnibus Regulation and Associated Amendments. December 20, 2021. <https://ww2.arb.ca.gov/sites/default/files/barcu/regact/2020/hdomnibuslownox/foraddendum.pdf>.

<sup>356</sup> EPA is reviewing a waiver request under CAA section 209(b) from California for the Omnibus rule; note, we are making no determination in this action about the appropriateness of these provisions for CARB's regulation.

of finalizing the threshold provisions as proposed, and a comment from CARB stating that three engine families have recently been certified to lower FELs indicating EPA should finalize lower thresholds. We note that CARB stated that two of these engine families were certified with deficiencies, and thus these engines did not fully meet all specific OBD requirements (see section 7.1 of the Response to Comment for further detail about these comments and EPA's responses). EPA is finalizing with minor revision future numerical values for OBD NO<sub>x</sub> and PM thresholds that align with the numerical value that results under today's NO<sub>x</sub> and PM emissions requirements.

We are finalizing as proposed a NO<sub>x</sub> threshold of 0.40 g/hp-hr and a PM threshold of 0.03 g/hp-hr for compression-ignition engines for operation on the FTP and SET duty cycles. We are finalizing as proposed a PM threshold of 0.015 g/hp-hr for spark-ignition engines for operation on the FTP and SET duty cycles. For spark-ignition engines, we proposed NO<sub>x</sub> thresholds of 0.30 and 0.35 g/hp-hr for monitors detecting a malfunction before NO<sub>x</sub> emissions exceed 1.5 and 1.75 times the applicable standard, respectively. We are finalizing these numeric threshold values without reference to what percent exceedance is relevant and instead are clarifying that the 0.35g/hp-hr standard applies for catalyst monitors and that 0.30g/hp-hr applies for all other monitors, to ensure the proper numeric thresholds can be applied to engines certified under 13 CCR 1968.2 and 1971.1. EPA intends to continue to evaluate the capability of HD OBD monitors to accommodate lower thresholds to correspond to the lower emission levels for the final emission standards and may consider updating threshold requirements in the future as more in-use data becomes available.

We also inadvertently omitted from the proposed 40 CFR 1036.110(b) the specific threshold criteria for SI and CI engine HC and CO emissions that coincided with our overall expressed intent to harmonize with the threshold requirements included in CARB's Omnibus rule and not tighten OBD emission thresholds.<sup>357</sup> Consistent with this intent, we are finalizing a provision in 40 CFR 1036.110(b)(5) that instructs manufacturers to use numeric values that correspond to existing HC and CO standards (0.14 g/hp-hr for HC, 15.5 g/

hp-hr for CO from compression-ignition engines, and 14.4 g/hp-hr for spark-ignition engines) to determine the required thresholds. Applying this methodology will result in calculations that produce thresholds equivalent to existing thresholds. Including this clarification avoids unintentionally lowering such thresholds.

#### b. Test-Out Criteria

CARB OBD requirements include "test-out" provisions in 13 CCR 1968.2 and 1971.1 which allow manufacturers to be exempt from monitoring certain components if failure of these components meets specified criteria.<sup>358</sup> EPA is adopting these test-out provisions through the incorporation by reference of CARB's updated 2019 OBD requirements. Similar to the revisions we proposed and are finalizing for malfunction criteria, EPA's assessment is that for compression ignition engines test-out criteria should also not be tightened at this time. However, we inadvertently omitted from the proposed 40 CFR 1036.110(b) the specific adjustments to test-out criteria for compression-ignition engines included in CARB's Omnibus rule that are necessary to result in such criteria not being tightened. Consistent with our overall expressed intent to (1) not tighten OBD requirements, and (2) modify the 2019 CARB requirements we are adopting by harmonizing with the numeric values included in CARB's Omnibus rule, we are finalizing a revision from the proposal to include test-out criteria calculation instructions into our regulations.

Specifically, we are finalizing a provision that manufacturers seeking to use the test-out criteria to exempt engines from certain monitoring in the incorporated by reference 2019 CARB regulations 13 CCR 1968.2 and 1971.1 must calculate the criteria based on specified values provided in 40 CFR 1036.110(b)(5). For example, 13 CCR 1971.1(e)(3.2.6) specifies that one of the requirements for an EGR catalyst to be exempt from monitoring is if no malfunction of the EGR catalyst can cause emissions to increase by 15 percent or more of the applicable standard as measured from the appropriate test cycle. The requirement we are finalizing in 40 CFR 1036.110(b)(5) instructs manufacturers to use specific values for that "applicable standard" to calculate the

required test-out criteria. For example, for the EGR catalyst test-out provision, this would result in a NO<sub>x</sub> test-out criterion of 0.03 g/hp-hr (0.2 g/hp-hr • 0.15). Including this provision is consistent with the intent of our proposal and avoids unintentionally lowering such test-out criteria that would render such test-out criteria generally inconsistent with the other provisions we are finalizing in 40 CFR 1036.110(b)(5), and enables manufacturers to continue using these provisions.

#### c. Applicable Thresholds for Engines Certified to 40 CFR Part 1036 Used in Heavy-Duty Vehicles Less Than 14,000 Pounds GVWR

We are finalizing as proposed that engines installed in vehicles at or below 14,000 lbs GVWR are subject to OBD requirements under the light-duty program in 40 CFR 86.1806–17. Commenters pointed out that the proposed rule did not specify alternative thresholds for engines certified to 40 CFR part 1036 on an engine dynamometer that are subject to OBD requirements under 40 CFR 86.1806–17. Without such a provision, manufacturers would be subject to the existing thresholds in 40 CFR 86.1806–17 that are based on standards set for light-duty chassis-certified vehicles. Consistent with our statements in the NPRM that our proposal intended to harmonize with the threshold requirements included in CARB's Omnibus policy and not lower emission threshold levels in our proposed OBD regulations, we are clarifying in 40 CFR 86.1806–17(b)(9) that the thresholds we are finalizing in 40 CFR 1036.110(b)(5) apply equally for engines certified under 40 CFR part 1036 that are used in vehicles at or below 14,000 lbs GVWR.

#### iii. Additional OBD Provisions in the Proposed Federal Program

In the NPRM, EPA proposed to include additional requirements to ensure that OBD can be used to properly diagnose and maintain emission control systems to avoid increased real-world emissions. This was also a part of our effort to update EPA's OBD program and respond to numerous concerns raised in the ANPR about the difficulty of diagnosing and maintaining proper functionality of advanced emission control technologies and the important role accessible and robust diagnostics play in this process. At this time, after consideration of comments, we are finalizing a limited set of these proposed provisions (see section 7 of the Response to Comments documents for further detail on comments and

<sup>357</sup> While CARB standards refer to nonmethane hydrocarbon standards as "NMHC" EPA's regulation refers to "HC" generically for such standards, but we define HC in 40 CFR 1036.104 to be NMHC for gasoline- and diesel-fueled engines.

<sup>358</sup> "Test-out" provisions may be identified in CARB OBD regulations specifically as "test-out" requirements or through language describing that certain components or systems are "exempt from monitoring" if manufacturers can demonstrate certain conditions are met.

EPA's responses). Where OBD requirements between EPA and CARB may differ, EPA is finalizing as proposed provisions allowing us to accept CARB OBD approval as long as a manufacturer can demonstrate that the CARB program meets the intent of EPA OBD requirements and submits documentation as specified in 40 CFR 1036.110(b).

In this section we describe the final additional EPA certification requirements in 40 CFR 1036.110 for OBD systems, which, consistent with CAA section 202(m),<sup>359</sup> are intended to provide more information and value to the operator and play an important role in ensuring expected in-use emission reductions are achieved long-term. With respect to our proposed provisions to require additional information from OBD systems be made publicly available, we received supportive comments from operators and adverse comments from manufacturers. After considering these comments, we are revising our final provision from those proposed, as summarized here and provide in more detail in section 7 of the Response to Comments document. We are not taking final action at this time on the proposed requirement to include health monitors. In addition to driver information requirements we are adopting to increase the availability of serviceability and inducement-related information (see section IV.B.3 and IV.D.3 respectively of this preamble), we are also finalizing in 40 CFR 1036.110(c) that the following information must be made available in the cab on-demand in lieu of the proposed health monitors:

- The total number of diesel particulate filter regeneration events that have taken place since installing the current particulate filter.
- Historical and current rate of DEF consumption (*e.g.*, gallons of DEF consumed per mile or gallons of DEF consumed per gallon of diesel fuel consumed.) This information is designed such that operators can reset it as needed to capture specific data for comparison purposes.
- For AECD conditions (outside of inducements) related to SCR or DPF systems that derate the engine (*e.g.*, either a speed or torque reduction), the fault code for the detected problem, a

<sup>359</sup> For example, CAA section 202(m)(5) specifies that by regulation EPA shall require (subject to an exception where information is entitled to protection as trade secrets) manufacturers to provide promptly to any person engaged in the repairing or servicing of heavy-duty engines with any and all information needed to make use of the emission control diagnostics system required under CAA section 202 and such other information including instructions for making emission related diagnosis and repairs.

description of the fault code, and the current restriction.

For all other health monitor provisions proposed in 40 CFR 1036.110(c)(3), we are not taking final action on those proposed provisions at this time.

In addition to incorporating an improved list of publicly available data parameters by harmonizing with updated CARB OBD requirements, in 40 CFR 1036.110(b)(9) EPA is finalizing as proposed for the reasons explained further in the proposal to add signals to the list, including to specifically require that all parameters related to fault conditions that trigger vehicle inducement also be made readily available using generic scan tools. EPA expects that each of these additional requirements will be addressed even where manufacturers relied in part on a CARB OBD approval to satisfy Federal requirements in order to demonstrate under 40 CFR 1036.110(b) that the engine meets the intent of 40 CFR 1036.110. The purpose of including additional parameters is to make it easier to identify malfunctions of critical aftertreatment related components, especially where failure of such components would trigger an inducement. We are revising the proposed new parameters for HD SI engines in 40 CFR 1036.110(b)(10) after considering comments. See section 3 of the Response to Comments.

We are also finalizing a general requirement in 40 CFR 1036.110(b)(9)(vi) to make all parameters available that are used as the basis for the decision to put a vehicle into an SCR- or DPF-related derate. For example, if the failure of an open-circuit check for a DEF quality sensor leads to an engine inducement, the owner/operator would be able to identify this fault condition using a generic scan tool. We are finalizing a requirement that manufacturers make additional parameters available for all engines so equipped,<sup>360</sup> including:

- For Compression Ignition engines:
  - Inlet DOC and Outlet DOC pressure and temperature
  - DPF Filter Soot Load (for all installed DPFs)
  - DPF Filter Ash Load (for all installed DPFs)
  - Engine Exhaust Gas Recirculation Differential Pressure
  - DEF quality-related signals
  - Parking Brake, Neutral Switch, Brake Switch, and Clutch Switch Status
  - Aftertreatment Dosing Quantity Commanded and Actual

<sup>360</sup> Memorandum to Docket EPA-HQ-OAR-2019-0055: "Example Additional OBD Parameters". Neil Miller, Amy Kopin. November 21, 2022.

- Wastegate Control Solenoid Output
- Wastegate Position Commanded and Actual
- DEF Tank Temperature
- DEF Doser Control Status
- DEF System Pressure
- DEF Pump Commanded Percentage
- DEF Coolant Control Valve Control Position Commanded and Actual
- DEF Line Heater Control Outputs
- Speed and output shaft torque consistent with 40 CFR 1036.115(d)
  - For Spark Ignition Engines:
- Air/Fuel Enrichment Enable flags: Throttle based, Load based, Catalyst protection based
- Percent of time not in stoichiometric operation (including per trip and since new)

One of the more useful features in the CARB OBD program for diagnosing and repairing emissions components is the requirement for "freeze frame" data to be stored by the system. To comply with this requirement, manufacturers must capture and store certain data parameters (*e.g.*, vehicle operating conditions such as the NO<sub>x</sub> sensor output reading) within 10 seconds of the system detecting a malfunction. The purpose of storing this data is in part to record the likely area of malfunction. EPA is finalizing a requirement in 40 CFR 1036.110(b)(8) to require that manufacturers capture the following elements as freeze frame data: Those data parameters specified in 1971.1(h)(4.2.3)(E), 1971.1(h)(4.2.3)(F), and 1971.1(h)(4.2.3)(G). We are also specifying that these additional parameters would be added according to the specifications in 13 CCR 1971.1(h)(4.3). EPA believes this is essential information to make available to operators for proper maintenance.

#### iv. Demonstration Testing Requirements

Existing requirements of 40 CFR 86.010–18(l) and 13 CCR 1971.1(l) specify the number of test engines for which a manufacturer must submit monitoring system demonstration emissions data. Specifically, a manufacturer certifying one to five engine families in a given model year must provide emissions test data for a single test engine from one engine rating, a manufacturer certifying six to ten engine families in a given model year must provide emissions test data for a single test engine from two different engine ratings, and a manufacturer certifying eleven or more engine families in a given model year must provide emissions test data for a single test engine from three different engine ratings.

EPA received supportive and adverse comment on a proposed flexibility to

reduce redundant demonstration testing requirements for certain engines where an OBD system designed to comply with California OBD requirements is being used in both a CARB proposed family and a proposed EPA-only family and the two families are also identical in all aspects material to expected emission characteristics. EPA issued guidance last year on this issue.<sup>361</sup> We are finalizing as proposed to codify this guidance as a provision, subject to certain information submission requirements for EPA to evaluate if this provision's requirements have been met, for model years 2027 and later engines in 40 CFR 1036.110(b)(11).

Manufacturers may also use the flexibility in earlier model years. More specifically, we are finalizing the provision as proposed to count two equivalent engines families as one for the purposes of determining OBD demonstration testing requirements, where equivalent means they are identical in all aspects material to emission characteristics, as such, testing is not necessary to ensure a robust OBD program. 40 CFR 1036.110(b)(11) requires manufacturers to submit additional information as needed to demonstrate that the engines meet the requirements of 40 CFR 1036.110 that are not covered by the California Executive order, as well as results from any testing performed for certifying engine families (including equivalent engine families) with the California Air Resources Board and any additional information we request as needed to evaluate whether the requirements of this provision are met.

We took comment on and are finalizing language that this flexibility will apply for cases where equivalent engine families also have different inducement strategies. We are aware that the auxiliary emission control devices (AECs) needed to implement the engine derating associated with inducements do not affect engine calibrations in a way that would prevent OBD systems from detecting when emissions exceed specified levels. Rather, those AECs simply limit the range of engine operation that is available to the driver. Thus, testing of different inducement strategies in these AECs would also not be necessary to ensure a robust OBD program and we would consider such differences between engines to not be material to

emission characteristics relevant to these OBD testing requirements. Any difference in impacts between the engines would be a consequence of the driver's response to the inducement itself, which could also occur even with the same inducement strategy, rather than a difference in the functioning of the OBD systems in the engines. In that way, inducements are analogous to warranty for purposes of counting engine families for OBD testing requirements. See section 8 of the Response to Comments for details on the comments received and EPA's responses.

#### v. Use of CARB OBD Approval for EPA OBD Certification

Existing EPA OBD regulations allow manufacturers seeking an EPA certificate of conformity to comply with the Federal OBD requirements by demonstrating to EPA how the OBD system they have designed to comply with California OBD requirements also meets the intent behind Federal OBD requirements, as long as the manufacturer complies with certain certification documentation requirements. EPA has implemented these requirements by allowing a manufacturer to submit an OBD approval letter from CARB for the equivalent engine family where a manufacturer can demonstrate that the CARB OBD program has met the intent of the EPA OBD program. In other words, EPA has interpreted these requirements to allow OBD approval from CARB to be submitted to EPA for approval. We are finalizing as proposed to migrate the language from 40 CFR 86.010–18(a)(5) to 40 CFR 1036.110(b) to allow manufacturers to continue to use a CARB OBD approval letter to demonstrate compliance with Federal OBD regulations for an equivalent engine family where manufacturers can demonstrate that the CARB OBD program has met the intent of the EPA OBD program.

To demonstrate that your engine meets the intent of EPA OBD requirements, we are finalizing as proposed that the OBD system must address all the provisions described in 40 CFR 1036.110(b) and (c) and adding clarification in 40 CFR 1036.110(b) that manufacturers must submit information demonstrating that all EPA requirements are met. In the case where a manufacturer chooses not to include information showing compliance with additional EPA OBD requirements in their CARB certification package (e.g., not including the additional EPA data parameters in their CARB certification documentation), EPA expects

manufacturers to provide separate documentation along with the CARB OBD approval letter to show they have met all EPA OBD requirements. This process also applies in potential future cases where CARB has further modified their OBD requirements such that they are different from but meet the intent of existing EPA OBD requirements. EPA expects manufacturers to submit documentation as is currently required by 40 CFR 86.010–18(m)(3), detailing how the system meets the intent of EPA OBD requirements and information on any system deficiencies. As a part of this update to EPA OBD regulations, we are clarifying as proposed in 40 CFR 1036.110(b)(11)(iii) that we can request that manufacturers send us information needed for us to evaluate how they meet the intent of our OBD program using this pathway. This would often mean sending EPA a copy of documents submitted to CARB during the certification process.

#### vi. Use of the SAE J1979–2 Communications Protocol

In a February 2020 workshop, CARB indicated their intent to propose allowing the use of Unified Diagnostic Services (“UDS”) through the SAE J1979–2 communications protocol for heavy-duty OBD with an optional implementation as early as MY 2023.<sup>362 363</sup> The CARB OBD update that includes this UDS proposal has not yet been finalized, but was submitted to California's Office of Administrative Law for approval in July of 2022.<sup>364</sup> CARB stated that engine manufacturers are concerned about the limited number of remaining undefined 2-byte diagnostic trouble codes (“DTC”) and the need for additional DTCs for hybrid vehicles. SAE J1979–2 provides 3-byte DTCs, significantly increasing the number of DTCs that can be defined. In addition, this change would provide additional features for data access that improve the usefulness of generic scan tools to repair vehicles.

This update has not been finalized by CARB in time for us to include it in this final rule. In consideration of manufacturers who want to certify their engine families in the future for

<sup>362</sup> SAE J1979–2 was issued on April 22, 2021 and is available here: [https://www.sae.org/standards/content/j1979-2\\_202104/](https://www.sae.org/standards/content/j1979-2_202104/).

<sup>363</sup> CARB Workshop for 2020 OBD Regulations Update, February 27, 2020. Available here: [https://ww3.arb.ca.gov/msprog/obdprog/obd\\_feb2020\\_wspresentation.pdf](https://ww3.arb.ca.gov/msprog/obdprog/obd_feb2020_wspresentation.pdf).

<sup>364</sup> CARB Proposed Revisions to the On-Board Diagnostic System Requirements and Associated Enforcement Provisions for Passenger Cars, Light-Duty Trucks, Medium-Duty Vehicles and Engines, and Heavy-Duty Engines, available: <https://ww2.arb.ca.gov/rulemaking/2021/obd2021>.

<sup>361</sup> EPA Guidance Document CD–2021–04 (HD Highway), April 26, 2021, “Information on OBD Monitoring System Demonstration for Pairs of EPA and CARB Families Identical in All Aspects Other Than Warranty.” Available here: [https://iaspub.epa.gov/otaqpub/display\\_file.jsp?docid=52574&flag=1](https://iaspub.epa.gov/otaqpub/display_file.jsp?docid=52574&flag=1).



nationwide use, and after consideration of expected environmental benefits associated with the use of this updated protocol, we are finalizing as proposed a process for reviewing and approving manufacturers' requests to comply using the alternative communications protocol.

While EPA believes our existing requirements in 40 CFR 86.010–18(a)(5) allow us to accept OBD systems using SAE J1979–2 that have been approved by CARB, there may be OEMs that want to obtain an EPA-only certificate (*i.e.*, does not include certification to California standards) for engines that do not have CARB OBD approval for MYs prior to MY 2027 (*i.e.*, prior to when the 40 CFR part 1036 OBD provisions of this final rule become mandatory). EPA is finalizing as proposed to allow the use of SAE J1979–2 for manufacturers seeking EPA OBD approval. We are adopting this as an interim provision in 40 CFR 1036.150(v) to address the immediate concern for model year 2026 and earlier engines. Once EPA's updated OBD requirements are in effect for MY 2027, we expect to be able to allow the use of SAE J1979–2 based on the final language in 40 CFR 1036.110(b); however, we do not specify an end date for the provision in 40 CFR 1036.150(v) to make sure there is a smooth transition toward using SAE J1979–2 for model years 2027 and later. This provides manufacturers the option to upgrade their OBD protocol to significantly increase the amount of OBD data available to owners and repair facilities.

CAA section 202(m)(4)(C) requires that the output of the data from the emission control diagnostic system through such connectors shall be usable without the need for any unique decoding information or device, and it is not expected that the use of SAE J1979–2 would conflict with this requirement. Further, CAA section 202(m)(5) requires manufacturers to provide promptly to any person engaged in the repairing or servicing of motor vehicles or motor vehicle engines, and the Administrator for use by any such persons, with any and all information needed to make use of the emission control diagnostics system prescribed under this subsection and such other information including instructions for making emission related diagnosis and repairs. Manufacturers that voluntarily use J1979–2 as early as MY 2022 under interim provision 40 CFR 1036.150(v) would need to provide access to systems using this alternative protocol at that time and meet all the relevant requirements in 40 CFR 86.010–18 and 1036.110. EPA did not receive adverse

comment on the availability of tools that can read the new protocol from manufacturers or tool providers. CARB commented that staff anticipates tool vendors will be able to fully support the SAE J1979–2 protocol at a fair and reasonable price for the vehicle repair industry and consumers.

## 2. Cost Impacts

Heavy-duty engine manufacturers currently certify their engines to meet CARB's OBD regulations before obtaining EPA certification for a 50-state OBD approval. We anticipate most manufacturers will continue to certify with CARB and that they will certify to CARB's 2019 updated OBD regulations well in advance of the EPA program taking effect; therefore, we anticipate the incorporation by reference of CARB's 2019 OBD requirements will not result in any additional costs. EPA does not believe the additional OBD requirements described here will result in any significant costs, as there are no requirements for: New monitors, new data parameters, new hardware, or new testing included in this rule. However, EPA has accounted for possible additional costs that may result from the final expanded list of public OBD parameters in the "Research and Development Costs" of our cost analysis in Section V. EPA recognizes that there could be cost savings associated with reduced OBD testing requirements under final 40 CFR 1036.110(c)(11). For example, cost savings could come from the provision to not count engine families certified separately by EPA and CARB, but otherwise identical in all aspects material to expected emission characteristics, as different families when determining OBD demonstration testing (see section IV.C.1.iv of this document for further discussion on this provision). This potential reduction in demonstration testing burden could reduce costs such as labor and test cell time. However, manufacturers may choose not to certify engine families in this manner which would not translate to cost savings. Therefore, given the uncertainty in the potential for savings, we did not quantify the costs savings associated with this final provision.

## D. Inducements

Manufacturers have deployed urea-based SCR systems to meet the existing heavy-duty engine emission standards. EPA anticipates that manufacturers will continue to use this technology to meet the new NO<sub>x</sub> standards finalized in this rule. SCR is very different from other emission control technologies in that it requires operators to maintain an adequate supply of diesel exhaust fluid

(DEF), which is generally a water-based solution with 32.5 percent urea. Operating an SCR-equipped engine without DEF or certain components like an SCR catalyst could cause NO<sub>x</sub> emissions to increase to levels comparable to having no NO<sub>x</sub> controls at all.

The proposed rule described two key aspects of how our regulations currently require manufacturers to ensure engines will operate with an adequate supply of high-quality DEF, which we proposed to update and further codify. First, manufacturers currently must demonstrate compliance with our critical emissions-related schedule maintenance requirements, including 40 CFR 86.004–25(b). EPA has approved DEF refills as part of manufacturers' scheduled maintenance. EPA's approval is conditioned on manufacturers demonstrating that operators are reasonably likely to perform such maintenance. Manufacturers have consistently made this demonstration by designing their engines to go into a disabled mode that decreases a vehicle's maximum speed if the engine detects that operators are failing to provide an adequate supply of DEF. More specifically, manufacturers have generally complied by programming engines to restrict peak vehicle speeds after detecting that such maintenance has not been performed or detecting that tampering with the SCR system may have occurred. We refer to this strategy of derating engine power and vehicle speed as an "inducement."

Second, EPA's current regulations in 40 CFR 86.094–22(e) require that manufacturers comply with emission standards over the full adjustable range of "adjustable parameters," and that, in determining the parameters subject to adjustment, EPA considers the likelihood that settings other than the manufacturer's recommended setting will occur in-use, including the effect of settings other than the manufacturer's recommended settings on engine performance. We have historically considered DEF level and quality as parameters that can be physically adjusted and may significantly affect emissions. EPA generally has approved manufacturers strategies consistent with guidance that described recommendations on ways manufacturers could meet adjustable parameter requirements when using SCR systems.<sup>365</sup> This guidance states that manufacturers should demonstrate that operators are being made aware that DEF needs to be replaced through warnings and vehicle performance

<sup>365</sup> See CISD–09–04 REVISED.

deterioration that should not create undue safety concerns but be onerous enough to discourage drivers from operating without DEF (*i.e.*, through inducement). See the proposed rule preamble for further background and discussion of the basis of EPA's proposed inducement regulations.

With some modification from the proposal, EPA is adopting final inducement regulations in this final rule. The regulatory provisions also include changes compared to existing inducement guidance after consideration of manufacturer designs and operator experiences with SCR over the last several years. The inducement requirements included in this final rule supersede the existing guidance and are mandatory beginning in MY 2027 and voluntary prior to that and are intended to—

- Ensure that all critical emission-related scheduled maintenance has a reasonable likelihood of being performed while also deterring tampering of the SCR system.
- Set an appropriate inducement speed derating schedule that reflects experience gained over the past decade with SCR systems.
- Recognize the diversity of the real-world fleet with derate schedules that are tailored to a vehicle's operating characteristics.
- Improve the type and amount of information operators receive from the vehicle to both understand inducement actions and to help avoid or quickly remedy a problem that is causing an inducement.
- Allow operators to perform an inducement reset by using a generic scan tool or allowing for the engine to self-heal during normal driving.
- Address operator frustration with false inducements and low inducement speed restrictions that occur quickly, in part due to concern that such frustration may potentially lead to in-use tampering of the SCR system.

This final rule includes several changes from the proposed rule after consideration of numerous comments. See section 8 of the Response to Comments for the detailed comments and EPA's response to those comments, including further discussion of the changes in the final rule compared to the proposed rule. As an overview, EPA is adopting as a maintenance requirement, as proposed, in 40 CFR 1036.125(a)(1) that manufacturers must meet the specifications in new 40 CFR 1036.111, which contains requirements for inducements related to SCR, to demonstrate that timely replenishment with high-quality DEF is reasonably likely to occur on in-use engines and

that adjustable parameter requirements will be met. Specifically, EPA is finalizing as proposed to specify in 40 CFR 1036.115(f) that DEF supply and DEF quality are adjustable parameters. Regarding DEF supply, we are finalizing as proposed that the physically adjustable range includes any amount of DEF that the engine's diagnostic system does not recognize as a fault condition under new 40 CFR 1036.111. We are adopting a requirement under new 40 CFR 1036.115(i) for manufacturers to size DEF tanks corresponding to refueling events, which is consistent with the regulation we are replacing under 40 CFR 86.004–25(b)(4)(v). Under the final requirements, manufacturers can no longer use the alternative option in 40 CFR 86.004–25(b)(6)(ii)(F) to demonstrate high-quality DEF replenishment is reasonably likely to be performed in use. As described in the proposed rule, EPA plans to continue to rely on the existing guidance in CD–13–13 that describes how manufacturers of heavy-duty highway engines determine the practically adjustable range for DEF quality. We inadvertently proposed to require that manufacturers use the physically adjustable range for DEF quality as the basis for defining a fault condition for inducements under 40 CFR 1036.111. Since we intended for the existing guidance to address issues related to the physically adjustable range for DEF quality, we are not finalizing the proposed provision in 40 CFR 1036.115(f)(2) for DEF quality. EPA intends further consider the relationship between inducements and the practically adjustable range for DEF quality and may consider updating this guidance in the future.

EPA is adopting requirements that inducements be triggered for three types of fault conditions: (1) DEF supply is low, (2) DEF quality does not meet manufacturer specifications, or (3) tampering with the SCR system. EPA is not taking final action at this time on the proposed requirement for manufacturers to include a NO<sub>x</sub> override to prevent false inducements. After consideration of public comments, the final inducement provisions at 40 CFR 1036.111 include updates from the proposed inducement schedules; more specifically, EPA is adopting separate inducement schedules for low-, medium-, and high-speed vehicles. EPA is also finalizing requirements for manufacturers to improve information provided to operators regarding inducements. The final rule also includes a requirement for manufacturers to design their engines to remove inducements after proper

repairs are made, through self-healing or with the use of a generic scan tool to ensure that operators have performed the proper maintenance.

These requirements apply starting in MY 2027, though manufacturers may optionally comply with these 40 CFR part 1036 requirements in lieu of provisions that apply under 40 CFR part 86 early. The following sections describe the inducement requirements for the final rule in greater detail.

#### 1. Inducement Triggers

Three types of fault conditions trigger inducements under 40 CFR 1036.111. The first triggering condition is DEF quantity. Specifically, we require that SCR-equipped engines trigger an inducement when the amount of DEF in the tank has been reduced to a level corresponding to three remaining hours of engine operation. This triggering condition ensures that operators will be compelled to perform the necessary maintenance before the DEF supply runs out, which would cause emissions to increase significantly.

The second triggering condition is DEF quality failing to meet manufacturer concentration specifications. This triggering condition ensures high quality DEF is used.

Third, EPA is requiring inducements to ensure that SCR systems are designed to be tamper-resistant. We are requiring that manufacturers design their engines to monitor for and trigger an inducement for open-circuit fault conditions for the following components: (1) DEF tank level sensor, (2) DEF pump, (3) DEF quality sensor, (4) SCR wiring harness, (5) NO<sub>x</sub> sensors, (6) DEF dosing valve, (7) DEF tank heater, (8) DEF tank temperature sensor, and (9) aftertreatment control module (ACM). EPA is also requiring that manufacturers monitor for and trigger an inducement if the OBD system has any signal indicating that a catalyst is missing (see OBD requirements for this monitor in 13 CCR 1971.1(i)(3.1.6)). This list is the same as the list from the proposed rule, with two exceptions after consideration of comments. First, we are adding the DEF tank temperature sensor in the final rule. This additional sensor is on par with the DEF tank heater for ensuring that SCR systems are capable of monitoring for freezing conditions. Second, in consideration of comment, we are removing blocked DEF lines or dosing valves as a triggering condition because such a condition could be caused by crystallized DEF rather than any operator action and thus is not directly related to protecting against tampering with the SCR-system. We believe this standardized list of required

tampering inducement triggers will be important for owners, operators, and fleets in repairing their vehicles by avoiding excessive cost and time to determine the reason for inducement.

2. Derate Schedule

We are finalizing a different set of schedules than we proposed. First, we are adding a new category for medium-speed vehicles. Second, we are adjusting the low-speed category to have a lower final speed compared to the proposal and a lower average operating speed to identify this category. Third, we increased the average operating speed that qualifies a vehicle to be in the high-speed category. We are

adopting derate schedules for low-, medium- and high-speed vehicles as shown in Table IV–13. Similar to the proposal, we differentiate these three vehicle categories based on a vehicle’s calculated average speed for the preceding 30 hours of non-idle operation. Low-speed vehicles are those with an average operating speed below 15 mph. Medium-speed vehicles are those with average operating speeds at or above 15 and below 25 mph. High-speed vehicles are those with average operating speeds at or above 25 mph. Excluding idle from the calculation of vehicle speed allows us to more effectively evaluate each vehicle’s speed profile; in contrast, time spent at idle

would not help to give an indication of a vehicle’s operating characteristics for purposes of selecting the appropriate derate schedule. EPA chose these final speeds after consideration of stakeholder comments (see section 8.3 of the Response to Comments for further information on comments received) and an updated analysis of real-world vehicle speed activity data from the FleetDNA database maintained by the National Renewable Energy Laboratory (NREL).<sup>366 367</sup> Our analyses provided us with insight into the optimum way to characterize vehicles in a way to ensure these categories received appropriate inducements that would be neither ineffective nor overly restrictive.

TABLE IV–13—INDUCEMENT SCHEDULES

High-speed vehicles		Medium-speed vehicles		Low-speed vehicles	
Hours of non-idle engine operation	Maximum speed (mi/hr)	Hours of non-idle engine operation	Maximum speed (mi/hr)	Hours of non-idle engine operation	Maximum speed (mi/hr)
0	65	0	55	0	45
6	60	6	50	5	40
12	55	12	45	10	35
60	50	45	40	30	25
86	45	70	35		
119	40	90	25		
144	35				
164	25				

The derate schedule for each vehicle category is set up with progressively increasing severity to induce the owner or operator to efficiently address conditions that trigger inducements. Table IV–13 shows the derate schedules in cumulative hours. The initial inducement applies immediately when the OBD system detects any of the triggering fault conditions identified in section IV.D.1. The inducement schedule then steps down over time to result in the final inducement speed corresponding to each vehicle category. The inducement schedule includes a gradual transition (1mph every 5 minutes) at the beginning of each step of derate and prior to any repeat inducement occurring after a failed repair to avoid abrupt changes, as the step down in derate speeds in the schedules will be implemented while the vehicle is in motion. Inducements are intended to deteriorate vehicle performance to a point unacceptable for typical driving in a manner that is safe but onerous enough to discourage

vehicles from being operated (*i.e.*, impact the ability to perform work), such that operators will be compelled to replenish the DEF tank with high-quality DEF and not tamper with the SCR system’s ability to detect whether there is adequate high-quality DEF. To this end, as explained in the proposal, our analyses of vehicle operational data from NREL show that even vehicles whose operation is focused on local or intracity travel depend on frequently operating at highway speeds to complete commercial work.<sup>368</sup> Vehicles in an inducement under the schedules we are finalizing would not be able to maintain commercial functions. Our analysis of the NREL data also show that even medium- and low-speed vehicles travel at speeds up to 70 mph and indicate that it is likely regular highway travel is critical for low-speed vehicles to complete their work; for example, refuse trucks need to drop off collected waste at a landfill or transfer station before returning to neighborhoods.

Motorcoach operators submitted comments describing a greater sensitivity to any speed derate because of a much greater responsibility for carrying people safely to their intended destinations over longer distances, including their role in emergency response and national defense operations. After consideration of these comments, we are allowing manufacturers to design and produce engines that will be installed in motorcoaches with an alternative derate schedule that starts with a 65 mi/hr derate when a fault condition is first detected, steps down to 50 mi/hr after 80 hours, and concludes with a final derate speed of 25 mi/hr after 180 hours of non-idle operation. EPA is defining motorcoaches in 40 CFR 1036.801 to include buses that are designed to travel long distances with row seating for at least 30 passengers. This is intended to include charter services available to the general public.

Comments on the proposed inducement policy ranged from

<sup>366</sup> EPA’s original analysis of NREL data can be found here: Miller, Neil; Kopin, Amy. Memorandum to docket EPA–HQ–OAR–2019–0055–0981. “Review and analysis of vehicle speed activity data from the FleetDNA database.” October 1, 2021.

<sup>367</sup> EPA’s updated analysis of NREL data can be found here: Miller, Neil; Kopin, Amy. Memorandum to docket EPA–HQ–OAR–2019–0055. “Updated review and analysis of vehicle speed activity data from the FleetDNA database.” October 13, 2022.

<sup>368</sup> EPA’s updated analysis of NREL data can be found here: Miller, Neil; Kopin, Amy. Memorandum to docket EPA–HQ–OAR–2019–0055. “Updated review and analysis of vehicle speed activity data from the FleetDNA database.” October 13, 2022.

objecting to any speed restrictions to advocating that we adopt a 5 mph final derate speed. Some commenters supported the proposed rule, and some commenters asserted that decreasing final derate speeds would provide for greater assurance that operators would perform the necessary maintenance. There was a similar range of comments regarding the time specified for escalating the speed restrictions, with some commenters agreeing with the proposed schedule, and other commenters suggesting substantially more or less time.

We made several changes from proposal after consideration of comments, including three main changes. First, as noted in the preceding paragraphs, the final rule includes a medium-speed vehicle category. This allows us to adjust the qualifying criterion for high-speed vehicles to finalize a derate schedule similar to that proposed for vehicles that are clearly operating mostly on interstate highways over long distances. Similarly, the added vehicle category allows us to adjust the qualifying criterion for low-speed vehicles and adopt an appropriately more restrictive final derate schedule for those vehicles that are operating at lower speeds in local service.

Second, we developed unique schedules for escalating the speed restrictions for medium-speed and low-speed vehicles; this change was based on the expectation that vehicles with lower average speeds spend less time operating at highway speeds characteristic of inter-city driving and will therefore not need to travel substantial distances to return home for scheduling repair.

Third, we added derate speeds that go beyond the first four stages of derating that we proposed for high-speed vehicles, essentially reducing the final inducement speeds for all vehicles to be the same as low-speed vehicles. In other words, as shown in Table IV-13, both high- and medium-speed vehicles eventually derate to the same speeds as low-speed vehicles, after additional transition time after the derate begins. For example, the final derate schedule for high-speed vehicles goes through the proposed four derate stages for high-speed vehicles. At the fifth derate stage the vehicle begins to be treated like a medium-speed vehicle, starting at the third derate stage for medium-speed vehicles and progressing through the fifth derate stage for medium-speed vehicles. At the fifth derate stage the vehicle begins to be treated like a low-speed vehicle, similarly starting at the third derate stage for low-speed

vehicles. A similar step-down approach applies for medium-speed vehicles, transitioning down to the derate stages for low-speed vehicles. This progression is intended to address the concern that vehicle owners might reassign vehicles in their fleet to lower-speed service, or sell vehicles to someone who would use the vehicle for different purposes that don't depend on higher-speed operations. Our assessment is that the NREL data show that no matter what category vehicles are, they do not travel exclusively at or below 25 mph, indicating that vehicles derated to 25 mph cannot be operated commercially.

For the simplest type of maintenance, DEF refills, we fully expect that the initial stage of derated vehicle speed will be sufficient to compel vehicle operators to meet their maintenance obligations. We expect operators will add DEF routinely to avoid inducements; however, inducements begin three hours prior to the DEF tank being empty to better ensure operation with an empty DEF tank is avoided.

We expect that the derate schedules in this final rule will be fully effective in compelling operators to perform needed maintenance. This effectiveness will be comparable to the current approach under existing guidance, but will reduce operating costs to operators. We believe this measured approach will also result in lower tampering rates involving time.

### 3. Driver Information

In addition to the driver information requirements we are adopting to improve serviceability and OBD (see section IV.B.3 and IV.C.1.iii respectively of this preamble for more details on these provisions), we are also adopting improved driver information requirements for inducements. Specifically, we are adopting as proposed the requirement for manufacturers to increase the amount of information provided to the driver about inducements, including: (1) The condition causing the derate (*i.e.*, DEF quality, DEF quantity or tampering), (2) the fault code and description of the code associated with the inducement, (3) the current derate speed restriction, (4) hours until the next derate speed decrease, and (5) what the next derate speed will be. It is critical that operators have clear and ready access to information regarding inducements to reduce concerns over progressive engine derates (which can lead to motivations to tamper) as well as to allow operators to make timely informed decisions, especially since inducements are used by manufacturers to demonstrate that critical emissions-related maintenance

is reasonably likely to occur in-use. We note that we are finalizing this requirement at 40 CFR 1036.110(c), in a different regulatory section than proposed; however, the substance of the requirement is the same as at proposal.

EPA is requiring that all inducement-related diagnostic data parameters be made available with generic scan tools to help operators promptly respond when the engine detects fault condition requiring repair or other maintenance (see section IV.C.1.iii. for further information).

### 4. Clearing an Inducement Condition

Following restorative maintenance, EPA is requiring that the engine would allow the vehicle to self-heal if it confirms that the fault condition is resolved. The engine would then remove the inducement, which would allow the vehicle to resume unrestricted engine operation. EPA is also requiring that generic scan tools be able to remove an inducement condition after a successful repair. After clearing inducement-related fault codes, all fault codes are subject to immediate reevaluation that would lead to resuming the derate schedule where it was at the time the codes were cleared if the fault persists. Therefore, there is no need to limit the number of times a scan tool can clear codes. Use of a generic scan tool to clear inducements would allow owners who repair vehicles outside of commercial facilities to complete the repair without delay (*e.g.*, flushing and refilling a DEF tank where contaminated DEF was discovered). However, if the same fault condition repeats within 40 hours of engine operation (*e.g.*, in response to a DEF quantity fault an owner adds a small but insufficient quantity of DEF), this will be considered a repeat fault. In response to a repeat fault, the system will immediately resume the derate at the same point in the derate schedule when the original fault was deactivated. This is less time than the 80 hours EPA proposed in the NPRM, but it is consistent with existing EPA guidance. After consideration of comments, we believe that the shorter interval is long enough to give a reliable confirmation that a repair has properly addressed the fault condition, and are concerned that 80 hours would risk treating an unrelated occurrence of a fault condition as if it were a continuation of the same fault.

EPA is not finalizing the proposed provision that an inducement schedule is applied and tracked independently for each fault if multiple fault conditions are detected due to the software complexity for the

manufacturer in applying and tracking the occurrence of multiple derate schedules. Section 4 of the Response to Comments for further discussion of EPA's thinking to assist manufacturers regarding consideration for programming diagnostic systems to handle overlapping fault conditions.

#### 5. Further Considerations

EPA is not taking final action at this time on the proposed NO<sub>x</sub> override provision, which was proposed to prevent speed derates for fault conditions that are caused by component failures if the catalyst is nevertheless functioning normally. We received comments describing concerns with our proposed methodology, including the reliability of NO<sub>x</sub> sensors and use of OBD REAL NO<sub>x</sub> data, and concerns that reliance in this way on the NO<sub>x</sub> sensor could result in easier tampering. We are continuing to consider these issues and comments. We may consider such a provision in an appropriate future action. Our final inducement regulations will reduce the risk of false inducements and provide increased certainty during repairs by limiting inducements to well-defined fault conditions that focus appropriately on DEF supply, DEF quality, and tampering (open-circuit faults associated with missing aftertreatment hardware).

We have also learned from the last several years that it is important to monitor in-use experiences to evaluate whether the inducement provisions are striking the intended balance of ensuring an adequate supply of high-quality DEF in a way that is allowing for safe and timely resolution, even for cases involving difficult circumstances. For example, we might hypothetically learn from in-use experiences that component malfunctions, part shortages, or other circumstances are leaving operators in a place where inducements prevent them from operating and they are unable to perform maintenance that is needed to resolve the fault condition. Conversely, we might hypothetically learn that operators are routinely driving vehicles with active derates. Information from those in-use experiences may be helpful for future assessments of whether we should pursue adjustments to the derate schedules or other inducement provisions we are adopting in this final rule.

#### 6. In-Use Retrofits To Update Existing Inducement Algorithms

In the NPRM, we sought comment on whether it would be appropriate to allow engine manufacturers to modify

earlier model year engines to align with the new regulatory specifications. We did not propose changes to existing regulations to address this concern. Specifically, we sought comment on whether and how manufacturers might use field-fix practices under EPA's field fix guidance to modify in-use engines with algorithms that incorporate some or all the inducement provisions in the final rule. We received numerous comments on the need to modify existing inducement speeds and schedules from operator groups and at least one manufacturer.<sup>369</sup> We received comment on the use of field-fixes for this purpose from CARB, stating that CARB staff does not support the SCR inducement strategy proposed by EPA and does not support allowing field fixes for in-use vehicles or to amend the certification application of current model year engines for the NPRM inducement strategy. CARB staff also commented that they would support allowing field fixes for in-use vehicles or amending current certification applications only if EPA adopts an inducement strategy identical or similar to the one CARB proposed in their comments on the proposed rule.<sup>370</sup> For example, CARB suggested an inducement strategy with a 5 mph inducement after 10 hours, following an engine restart.

EPA believes field fixes with updated inducement algorithms may fall within EPA's field fix guidance for engines that have EPA-only certification (*i.e.*, does not include certification to California standards), but has concerns about such field fixes falling within the scope of the guidance for engines also certified by CARB if CARB considers such changes to be tampering with respect to requirements that apply in California. EPA intends to also consider alternative field fix inducement approaches that manufacturers choose to develop and propose to CARB and EPA, for engines certified by both EPA and CARB, such as approaches that provide a more balanced inducement strategy than that used in current certifications while still being effective.

#### E. Fuel Quality

EPA has long recognized the importance of fuel quality on motor vehicle emissions and has regulated fuel quality to enable compliance with emission standards. In 1993, EPA limited diesel sulfur content to a maximum of 500 ppm and put into

place a minimum cetane index of 40. Starting in 2006 with the establishment of more stringent heavy-duty highway PM, NO<sub>x</sub> and hydrocarbon emission standards, EPA phased-in a 15-ppm maximum diesel fuel sulfur standard to enable heavy-duty diesel engine compliance with the more stringent emission standards.<sup>371</sup>

EPA continues to recognize the importance of fuel quality on heavy-duty vehicle emissions and is not currently aware of any additional diesel fuel quality requirements necessary for controlling criteria pollutant emissions from these vehicles.

#### 1. Biodiesel Fuel Quality

As discussed in Chapter 2.3.2 of the RIA, metals (*e.g.*, Na, K, Ca, Mg) can enter the biodiesel production stream and can adversely affect emission control system performance if not sufficiently removed during production. Our review of data collected by NREL, EPA, and CARB indicates that biodiesel is compliant with the ASTM D6751–18 limits for Na, K, Ca, and Mg. As we explained in the proposed rule, the available data does not indicate that there is widespread off specification biodiesel blend stock or biodiesel blends in the marketplace. We did not propose and are not including at this time in this final rule requirements for biodiesel blend metal content.

While occasionally there are biodiesel blends with elevated levels of these metals, they are the exception. Data in the literature indicates that Na, K, Ca, and Mg levels in these fuels are less than 100 ppb on average. Data further suggests that the low levels measured in today's fuels are not enough to adversely affect emission control system performance when the engine manufacturer properly sizes the catalyst to account for low-level exposure.

Given the low levels measured in today's fuels, however, we are aware that ASTM is currently evaluating a possible revision to the measurement method for Na, K, Ca, and Mg in D6751–20a from EN14538 to a method that has lower detection limits (*e.g.*, ASTM D7111–16, or a method based on the ICP–MS method used in the 2016 NREL study). We anticipate that ASTM will likely specify Na, K, Ca, and Mg limits in a future update to ASTM 7467–19 for B6 to B20 blends that is an extrapolation of the B100 limits (see RIA Chapter 2.3.2 for additional discussion of ASTM test methods, as well as available data on levels of metal in biodiesel and potential impacts on emission control systems).

<sup>369</sup> See, for example, comments from the National Association of Small Trucking Companies, EPA–HQ–OAR–2019–0055–1130.

<sup>370</sup> See comments from California Air Resources Board, EPA–HQ–OAR–2019–0055–1186.

<sup>371</sup> 66 FR 5002 January 18, 2001.

## 2. Compliance Issues Related to Biodiesel Fuel Quality

Given the concerns we raised in the ANPR and NPRM regarding the possibility of catalyst poisoning from metals contained in biodiesel blends and specifically heavy-duty vehicles fueled on biodiesel blends, and after consideration of comments on the NPRM, EPA is finalizing a process where we will consider the possibility that an engine was not properly maintained under the provisions of 40 CFR part 1068, subpart F, if an engine manufacturer demonstrates that the vehicle was misfueled in a way that exposed the engine and its aftertreatment components to metal contaminants and that misfueling degraded the emission control system performance. This allows a manufacturer to receive EPA approval to exempt test results from being considered for potential recall. For example, a manufacturer might request EPA approval through this process for a vehicle that was historically fueled on biodiesel blends whose B100 blend stock did not meet the ASTM D6751–20a limit for Na, K, Ca, and/or Mg (metals which are a byproduct of current biodiesel production methods). This process requires the engine manufacturer to provide proof of historic misfueling with off-specification fuels; more specifically, to qualify for the test result exemption(s), a manufacturer must provide documentation that compares the degraded system to a representative compliant system of similar miles with respect to the content and amount of the contaminant. We are also finalizing a change from the proposal in the fuel requirements relevant to conducting in-use testing and to recruitment of vehicles for in-use testing. The new provision in 40 CFR 1036.415(c)(1) states that the person conducting the in-use testing may use any commercially available biodiesel fuel blend that meets the specifications for ASTM D975 or ASTM D7467 that is either expressly allowed or not otherwise indicated as an unacceptable fuel in the vehicle's owner or operator manual or in the engine manufacturer's published fuel recommendations. As specified in final 40 CFR 1036.410, if the engine manufacturer finds that the engine was fueled with fuel not meeting the specifications in 40 CFR 1036.415(c)(1), they may disqualify the vehicle from in-use testing and replace it with another one.

## F. Durability Testing

In this section, we describe the final deterioration factor (DF) provisions for heavy-duty highway engines, including migration and updates from their current location in 40 CFR 86.004–26(c) and (d) and 86.004–28(c) and (d) to 40 CFR 1036.245 and 1036.246. EPA regulations require that a heavy-duty engine manufacturer's application for certification include a demonstration that the engines will meet applicable emission standards throughout their regulatory useful life. This is often called the durability demonstration. Manufacturers typically complete this demonstration by following regulatory procedures to calculate a DF. Deterioration factors are additive or multiplicative adjustments applied to the results from manufacturer testing to quantify the emissions deterioration over useful life.<sup>372</sup>

Currently, a DF is determined directly by aging an engine and exhaust aftertreatment system to useful life on an engine dynamometer. This time-consuming service accumulation process requires manufacturers to commit to product configurations well ahead of their pre-production certification testing to complete the durability testing so EPA can review the test results before issuing the certificate of conformity. Some manufacturers run multiple, staggered durability tests in parallel in case a component failure occurs that may require a complete restart of the aging process.<sup>373</sup>

As explained in the NPRM, EPA recognizes that durability testing over a regulatory useful life is a significant undertaking, which can involve more than a full year of continuous engine operation for Heavy HDE to test to the equivalent of the current useful life of 435,000 miles. Manufacturers have been approved, on a case-by-case basis, to age their systems to between 35 and 50 percent of the current full useful life on an engine dynamometer, and then extrapolate the test results to full useful life.<sup>374</sup> This extrapolation reduces the time to complete the aging process, but data from a test program shared with EPA show that while engine out emissions for SCR-equipped engines were predictable and consistent, actual tailpipe emission levels were higher by the end of useful life when compared to emission levels extrapolated to useful life from service accumulation of 75 or

<sup>372</sup> See 40 CFR 1036.240(c) and the definition of "deterioration factor" in 40 CFR 1036.801, which, as proposed, are migrated and updated from 40 CFR 86.004–26 and 86.004–28 in this final rule.

<sup>373</sup> See 40 CFR 1065.415.

<sup>374</sup> See 40 CFR 86.004–26.

lower percent useful life.<sup>375 376</sup> In response to the new data indicating DFs generated by manufacturers using service accumulation less than useful life may not be fully representative of useful life deterioration, EPA initially worked with manufacturers and CARB to address this concern through guidance for MY 2020 and later engines.

While the current DF guidance is specific to SCR-equipped engines, in this final rule we are updating our DF provisions to apply certain aspects of the current DF guidance to all engine families starting in model year 2027.<sup>377</sup> We also are finalizing as proposed that manufacturers may optionally use these provisions to determine their deterioration factors for earlier model years. As noted in the following section, as proposed, we are continuing the option for Spark-ignition HDE manufacturers to request approval of an accelerated aging DF determination, as is allowed in our current regulations (see 40 CFR 86.004–26(c)(2)), and our final provision extends this option to all primary intended service classes. We are not finalizing any changes to the existing compliance demonstration provision in 40 CFR 1037.103(c) for evaporative and refueling emission standards. As introduced in Section III.E, in this rule we are also promulgating refueling emission standards for incomplete vehicles above 14,000 lb GVWR. As proposed, we are finalizing that incomplete vehicle manufacturers certifying to the refueling emission standards for the first time have the option to use engineering analyses to demonstrate durability using the same procedures that apply for the evaporative systems on their vehicles today.

In Section IV.F.1, we are finalizing two methods for determining DFs in a new 40 CFR 1036.245 with some modifications from those proposed, including a new option to bench-age the aftertreatment system to limit the burden of generating a DF over the lengthened useful life periods in Section IV.A.3. We are also codifying two DF verification options available to

<sup>375</sup> U.S. EPA. "Guidance on Deterioration Factor Validation Methods for Heavy-Duty Diesel Highway Engines and Nonroad Diesel Engines equipped with SCR." CD–2020–19 (HD Highway and Nonroad). November 17, 2020.

<sup>376</sup> Truck and Engine Manufacturers Association. "EMA DF Test Program." August 1, 2017.

<sup>377</sup> As noted in Section III.A, the final update to the definition of "engine configuration" in 40 CFR 1036.801, as proposed, clarifies that hybrid engines and powertrains are part of a certified configuration and subject to all of the criteria pollutant emission standards and other requirements; thus the DF provisions for heavy-duty engines discussed in this subsection will apply to configurations that include hybrid components.

manufacturers in the recent DF guidance, with some modifications from our proposed DF verification requirements. As described in Section IV.F.2, under the final 40 CFR 1036.245 and 40 CFR 1036.246, the final provisions include two options for DF verification to confirm the accuracy of the DF values submitted by manufacturers for certification, and will be required upon request from EPA. In Section IV.F.3, we introduce a test program to evaluate a rapid-aging protocol for diesel catalysts, the results of which we used to develop a rapid-aging test procedure for CI engine manufacturers to be able to use in their durability demonstration under 40 CFR 1036.245(c)(6). We are finalizing this procedure in 40 CFR part 1065, subpart L, as new sections 40 CFR 1065.1131 through 40 CFR 1065.1145.

At this time we are not finalizing any additional testing requirements for manufacturers to demonstrate durability of other key components included in a hybrid configuration (e.g., battery durability testing). We will consider additional requirements in a future rule as we pursue other durability-related provisions for EVs, PHEVs, etc.

As described in Section XI.A.8, we are also finalizing as proposed that manufacturers of nonroad engines may use the procedures described in this section to establish deterioration factors based on bench-aged aftertreatment, along with any EPA-requested in-use verification testing.

#### 1. Options for Determining Deterioration Factor

Accurate methods to demonstrate emission durability are key to ensuring certified emission levels represent real world emissions, and the efficiency of those methods is especially important in light of the lengthening of useful life periods in this final rule. To address these needs, we are migrating our existing regulatory option from part 86 to part 1036 and including a new option for heavy-duty highway engine manufacturers to determine DFs for certification. We note that manufacturers apply these deterioration factors to determine whether their engines meet the duty cycle standards.

Consistent with existing regulations, final 40 CFR 1036.245 allows manufacturers to continue the current practice of determining DFs based on engine dynamometer-based aging of the complete engine and aftertreatment system out to regulatory useful life. In addition, under the new DF determination option, which includes some modifications from that proposed and which are described in this section,

manufacturers perform dynamometer testing of an engine and aftertreatment system to a minimum required mileage that is less than regulatory useful life. Manufacturers then bench age the aftertreatment system to regulatory useful life and combine the aftertreatment system with an engine that represents the engine family. Manufacturers run the combined engine and bench-aged aftertreatment for at least 100 hours before collecting emission data for determination of the deterioration factor. Under this option, the manufacturer can use the accelerated bench-aging of diesel aftertreatment procedure described in Section IV.F.3 that is codified in the new sections 40 CFR 1065.1131 through 40 CFR 1065.1145 or propose an equivalent bench-aging procedure and obtain prior approval from the Agency. For example, a manufacturer might propose a different, established bench-aging procedure for other engines or vehicles (e.g., procedures that apply for light-duty vehicles under 40 CFR part 86, subpart S).

We requested comment on whether the new bench-aged aftertreatment option accurately evaluates the durability of the emission-related components in a certified configuration, including the allowance for manufacturers to define and seek approval for a less-than-useful life mileage for the dynamometer portion of the bench-aging option. This request for comment specifically included whether or not there is a need to define a minimum number of engine hours of dynamometer testing beyond what is required to stabilize the engine before bench-aging the aftertreatment, noting that EPA's bench-aging proposal focused on deterioration of emission control components.<sup>378</sup> We requested comment on including a more comprehensive durability demonstration of the whole engine, such as the recent diesel test procedures from CARB's Omnibus regulation that includes dynamometer-based service accumulation of 2,100 hours or more based on engine class and other factors.<sup>379</sup> We also requested comment on whether EPA should prescribe a standardized aging cycle for the dynamometer portion, as was done by

<sup>378</sup> We are updating, as proposed, the definition of "low-hour" in 40 CFR 1036.801 to include 300 hours of operation for engines with NO<sub>x</sub> aftertreatment to be considered stabilized.

<sup>379</sup> California Air Resources Board, "Appendix B-1 Proposed 30-Day Modifications to the Diesel Test Procedures", May 5, 2021, Available online: <https://ww2.arb.ca.gov/sites/default/files/barcu/regact/2020/hdomnibuslownox/30dayappb1.pdf>, page 54.

CARB in the Omnibus rule with their Service Accumulation Cycles 1 and 2.<sup>380</sup> We also requested cost and time data corresponding to the current DF procedures, and projections of cost and time for the proposed new DF options at the proposed new useful life mileages.

Some commentors supported the removal of the fuel-based accelerated DF determination method, noting that it has been shown to underestimate emission control system deterioration. Other commentors requested that EPA retain the option, noting that it has been historically allowed. Fuel-based accelerated aging accelerates the service accumulation using higher-load operation based on equivalent total fuel flow on a dynamometer. The engine is only operated out to around 35 percent of UL based on operating hours, however the high-load operation is intended to result in an equivalent aging out to full UL. EPA has assessed data from the EMA DF test program and determined that the data indicated that the aging mechanism of accelerating the aging at higher load differs from the actual in-use deterioration mechanism.<sup>381 382</sup> We are not including this option in the final provisions for determining DF based on our assessment of the available data and have removed the option in final 40 CFR 1036.245.

We also received general support of the use of accelerated aging cycles to manage the total cost and duration of the DF test, in addition to some commentors stating that the CARB DF determination procedure in the CARB Omnibus regulation is superior to the accelerated aging procedure EPA proposed in 40 CFR 1036.245(b)(2). The required hours of engine dynamometer aging in the CARB Omnibus procedure (roughly out to 20 percent of UL for a HHD engine) provide limited assurance on the performance of engine components out to UL, and thus primarily provide a short-term quality assurance durability program for engine hardware. While the purpose of EPA's DF determination procedure is to

<sup>380</sup> California Air Resources Board, "Staff Report: Initial Statement of Reasons for Proposed Rulemaking, Public Hearing to Consider the Proposed Heavy-duty Engine and Vehicle Omnibus Regulation and Associated Amendments," June 23, 2020. Available online: <https://ww3.arb.ca.gov/regact/2020/hdomnibuslownox/isor.pdf>, page III-80.

<sup>381</sup> U.S. EPA, "Guidance on Deterioration Factor Validation Methods for Heavy-Duty Diesel Highway Engines and Nonroad Diesel Engines equipped with SCR." CD-2020-19 (HD Highway and Nonroad). November 17, 2020.

<sup>382</sup> Truck and Engine Manufacturers Association. "EMA DF Test Program." August 1, 2017.

determine emission performance degradation over the useful life of the engine, we acknowledge that there is value in performing some engine dynamometer aging. We are finalizing an option to use accelerated reactor bench-aging of the emission control system that is ten times a dynamometer or field test (1,000 hours of accelerated aging would be equivalent to 10,000 hours of standard aging), requiring a minimum number of testing hours on an engine dynamometer, with the allowance for the manufacturer to add additional hours of engine dynamometer-aging at their discretion. The minimum required hours are by primary intended service class and follow: 300 hours for SI, 1,250 hours for Light HDE, and 1,500 hours for Medium HDE and Heavy HDE. This option allows the DF determination to be completed within a maximum of 180 days for a Heavy HDE. We recognize that a different approach, that uses the same aging duty-cycle for all manufacturers, would provide more consistency across engine manufacturers. However, no data was provided by commentors showing that the Service Accumulation Cycles 1 and 2 in the CARB Omnibus rule are any more effective at determining deterioration than cycles developed by the manufacturer and submitted to EPA for approval. EPA is also concerned regarding the amount of idle contained in each of the CARB Omnibus rule cycles. We realize that this idle operation was included to target the degradation mechanism that plagued the SAPO-34 SCR formulations used by manufacturers in the 2010s, however the catalyst developers are aware of this issue now and have developed formulations that are free from this degradation mechanism. The two most predominant degradation mechanisms are time at high temperature and sulfur exposure, including the effects of catalyst desulfation, and as such EPA favors duty-cycles with more aggressive aftertreatment temperature profiles. We understand that catalyst manufacturers now bench test the catalyst formulations under the conditions that led to the SAPO-34 degradation to ensure that this degradation mechanism is not present in newly developed SCR formulations. After taking all of the comments received into consideration, EPA has added two specified duty-cycle options in 40 CFR 1036.245(c) for DF determination, that are identical to CARB's Service Accumulation Cycles 1 and 2. Cycle 1 consists of a combination of FTP, RMC, LLC and extended idle, while Cycle 2 consists of a combination

of HDTT, 55-cruise, 65-cruise, LLC, and extended idle. In the case of the second option, the manufacturer is required to use good engineering judgment to choose the vehicle subcategory and vehicle configuration that yields the highest load factor using the GEM model. EPA is also providing an option for manufacturers to use their own duty cycles for DF determination subject to EPA approval and we expect a manufacturer to include light-load operation if it is deemed to contribute to degradation of the aftertreatment performance. We also note that we are finalizing requirements to stop, cooldown, and restart the engine during service accumulation when using the options that correspond to CARB Service Accumulation Cycles 1 and 2 for harmonization purposes, however we note that manufacturers may make a request to EPA to remove this requirement on a case-by-case basis.

We are finalizing critical emission-related maintenance as described in 40 CFR 1036.125(a)(2) and 1036.245(c) in this final rule. Under this final rule, manufacturers may make requests to EPA for approval for additional emission-related maintenance actions beyond what is listed in 40 CFR 1036.125(a)(2), as described in 40 CFR 1036.125(a)(1) and as allowed during deterioration testing under 40 CFR 1036.245(c).

## 2. Options for Verifying Deterioration Factors

We are finalizing, with some modifications from proposal, a new 40 CFR 1036.246 where, at EPA's request, the manufacturers would be required to verify an engine family's deterioration factor for each duty cycle up to 85 percent of useful life. Because the manufacturer must comply with emission standards out to useful life, we retain the authority to verify DF. We proposed requiring upfront verification for all engine families, but have decided to make this required only in the event that EPA requests verification. We intend to make such a request primarily when EPA becomes aware of information suggesting that there is an issue with the DF generated by the manufacturer. EPA anticipates that a DF verification request may be appropriate due to consideration of, for example: (1) Information indicating that a substantial number of in-use engines tested under subpart E of this part failed to meet emission standards, (2) information from any other test program or any other technical information indicating that engines will not meet emission standards throughout the useful life, (3) a filed defect report relating to the

engine family, (4) a change in the technical specifications for any critical emission-related components, and (5) the addition of a new or modified engine configuration such that the test data from the original emission-data engine do not clearly continue to serve as worst-case testing for certification. We are finalizing as proposed that manufacturers may request use of an approved DF on future model year engines for that engine family, using the final updates to carryover engine data provisions in 40 CFR 1036.235(d), with the final provision clarifying that we may request DF verification for the production year of that new model year as specified in the new 40 CFR 1036.246. As also further discussed in the following paragraphs, we are not finalizing at this time certain DF verification provisions that we had proposed regarding timing of when EPA may request DF verification and certain provisions for the first model year after a failed result. Our revisions from proposal appropriately provide flexibility for EPA to gather information based on DF concerns. The final provisions specify that we will discuss with the manufacturer the selection criteria for vehicles with respect to the target vehicle mileage(s) and production model year(s) that we want the manufacturer to test. We are finalizing that we will not require the manufacturer to select vehicles whose mileage or age exceeds 10 years or 85 percent of useful life.

We originally included three testing options in our proposed DF verification provisions. We are finalizing two of these options and we are not including the option to verify DF by measuring NO<sub>x</sub> emissions using the vehicle's on-board NO<sub>x</sub> measurement system at this time. For the two options we are finalizing, manufacturers select in-use engines meeting the criteria in 40 CFR 1036.246(a), including the appropriate mileage specified by EPA corresponding to the production year of the engine family.

Under the first verification option in 40 CFR 1036.246(b)(1), manufacturers test at least two in-use engines over all duty cycles with brake-specific emission standards in 40 CFR 1036.104(a) by removing each engine from the vehicle to install it on an engine dynamometer and measure emissions. Manufacturers determine compliance with the emission standards after applying infrequent regeneration adjustment factors to their measured results, just as they did when they originally certified the engine family. We are also finalizing a requirement under this option to allow EPA to request that manufacturers



perform a new determination of infrequent regeneration adjustment factors to apply to the emissions from the engine dynamometer-based testing. Consistent with the proposal, the engine family passes the DF verification if 70 percent or more of the engines tested meet the duty-cycle emission standards in 40 CFR 1036.104(a), including any associated compliance allowance, for each pollutant over all duty cycles. If a manufacturer chooses to test two engines under this option, both engines have to meet the standards. Under this option, the aftertreatment system, including all the associated wiring, sensors, and related hardware or software is installed on the test engine. We are finalizing an allowance in 40 CFR 1036.246(a) for the manufacturer to use hardware or software in testing that differs from those used for engine family and power rating with EPA approval.

Under the second verification option in 40 CFR 1036.246(b)(2), as proposed, manufacturers test at least five in-use engines, to account for the increased variability of vehicle-level measurement, while installed in the vehicle using a PEMS. Manufacturers bin and report the emissions following the in-use testing provisions in 40 CFR part 1036, subpart E. Compliance is determined by comparing emission results to the off-cycle emission standards in 40 CFR 1036.104(a) with any associated compliance allowance, mean ambient temperature adjustment, and, accuracy margin for each pollutant for each bin after adjusting for infrequent regeneration.<sup>383</sup> As proposed, the engine family passes the DF verification if 70 percent or more of the engines tested meet the off-cycle standards for each pollutant for each bin. In the event that EPA requested DF verification and a DF verification fails under the PEMS option, consistent with the proposal the manufacturer can reverse a fail determination for the PEMS-based testing and verify the DF using the engine dynamometer testing option in 40 CFR 1036.246(b)(1).

EPA is not including the third option we proposed, to verify DF using the vehicle's on-board NO<sub>x</sub> measurement system (*i.e.*, a NO<sub>x</sub> sensor), in the final provisions, as we have concerns that the technology has not matured enough to make this method viable for DF verification at this time. We did not receive any comments that supported the availability of technology to enable

<sup>383</sup> For Spark-ignition HDE, we are not finalizing off-cycle standards; however, for the in-use DF verification options, a manufacturer compares the engine's emission results to the duty cycle standards applying a 1.5 multiplier for model years 2027 and later.

accurate on-board NO<sub>x</sub> measurement at a level needed to show compliance with the standard. EPA acknowledges the challenges associated with the development of a functional onboard NO<sub>x</sub> measurement method, including data acquisition and telematic system capabilities, and may reconsider this option in the future if the technology evolves.

As noted in the preceding paragraphs, we are not taking final action at this time on the proposed 40 CFR 1036.246(h) provision that proposed a process for the first MY after a DF verification resulted in failure. Instead, we are adopting a process for DF verification failures similar to the existing process used for manufacturer run in-use testing failures under 40 CFR part 1036, subpart E, such that a failure may result in an expanded discovery process that could eventually lead to recall under our existing provisions in 40 CFR part 1068, subpart F. EPA is making this change from proposal because this approach provides consistency with and builds upon existing processes.

The final 40 CFR 1036.246(a) specifies how to select and prepare engines for testing. Manufacturers may exclude selected engines from testing if they have not been properly maintained or used and the engine tested must be in a certified configuration, including its original aftertreatment components. Manufacturers may test engines that have undergone critical emission-related maintenance as allowed in 40 CFR 1065.410(d), but may not test an engine if its critical emission-related components had any other major repair.

### 3. Accelerated Deterioration Factor Determination

As discussed in Section IV.F.1, we are finalizing a deterioration factor procedure where manufacturers use engine dynamometer testing for the required minimum number of hours given in Table 1 to Paragraph (c)(2) of 40 CFR 1036.245 in combination with an accelerated aftertreatment catalyst aging protocol in their demonstration of heavy-duty diesel engine aftertreatment durability through useful life. EPA has approved accelerated aging protocols for spark-ignition engine manufacturers to apply in their durability demonstrations for many years. Historically, while CI engine manufacturers have the ability to request EPA approval of an accelerated aging procedure, CI engine manufacturers have largely opted to seek EPA approval to use a service accumulation fuel based accelerated test with reduce mileage and extrapolate to determine their DF.

Other regulatory agencies have promulgated accelerated aging protocols,<sup>384 385</sup> and we have evaluated how these or similar protocols apply to our heavy-duty highway engine compliance program. EPA has validated and is finalizing an accelerated aging procedure in 40 CFR part 1065, subpart L, as new sections 40 CFR 1065.1131 through 40 CFR 1065.1145 that CI engine manufacturers can choose to use in lieu of developing their own protocol as described in 40 CFR 1036.245. The test program that validated the diesel aftertreatment rapid-aging protocol (DARAP) was built on existing accelerated aging protocols designed for light-duty gasoline vehicles (64 FR 23906, May 4, 1999) and heavy-duty engines.<sup>386</sup>

#### i. Diesel Aftertreatment Rapid Aging Protocol

The objective of the DARAP validation program was to artificially recreate the three primary catalytic deterioration processes observed in field-aged aftertreatment components: Thermal aging based on time at high temperature, chemical aging that accounts for poisoning due to fuel and oil contamination, and deposits. The validation program had access to three baseline engines that were field-aged to the model year 2026 and earlier useful life of 435,000 miles. Engines and their corresponding aftertreatment systems were aged using the current, engine dynamometer-based durability test procedure for comparison of the results to the accelerated aging procedure. We performed accelerated aging of the catalyst-based aftertreatment systems using two different methods with one utilizing a burner<sup>387</sup> and the other using an engine as the source of aftertreatment aging conditions. The validation test plan compared emissions at the following approximate intervals: 0 percent, 25 percent, 50 percent, 75 percent, and 100 percent of the model year 2026 and earlier useful life of 435,000 miles. At proposal, we included

<sup>384</sup> California Air Resources Board. California Evaluation Procedure For New Aftermarket Diesel Particulate Filters Intended As Modified Parts For 2007 Through 2009 Model Year On-Road Heavy-Duty Diesel Engines, March 1, 2017. Available online: <https://ww3.arb.ca.gov/regact/2016/aftermarket2016/amprcert.pdf>.

<sup>385</sup> European Commission. Amending Regulation (EU) No 583/2011, 20 September 2016. Available online: <https://eur-lex.europa.eu/legal-content/EN/TXT/PDF/?uri=CELEX:32016R1718&from=HU>.

<sup>386</sup> Eakle, S and Bartley, G (2014), "The DAAAC Protocol for Diesel Aftertreatment System Accelerated Aging".

<sup>387</sup> A burner is a computer controlled multi-fuel reactor designed to simulate engine aging conditions.

additional details of our DARAP test program in a memo to the docket.<sup>388</sup>

The DARAP validation program has completed testing of two rapidly aged aftertreatment systems, engine and burner, and two engines, a single FUL aged engine and a 300-hour aged engine. Our memo to the docket includes a summary of the validation results from this program. The results show that both accelerated aging pathways, burner and engine, produced rapidly aged aftertreatment system results that were not statistically significant when compared to the 9,800-hour dynamometer aged reference system. We are currently completing postmortem testing to evaluate the deposition of chemical poisoning on the surface of the substrates to see how this compares to the dynamometer aged reference system. The complete results from our validation program are contained in a final report in the docket.<sup>389</sup>

#### ii. Diesel Aftertreatment Accelerated Aging Test Procedure

The final provisions include an option for manufacturers to use the method from the DARAP test program for DF determination and streamline approval under 40 CFR 1036.245(c). This accelerated aging method we are finalizing in 40 CFR part 1065, subpart L, as new sections 40 CFR 1065.1131 through 40 CFR 1065.1145 is a protocol for translating field data that represents a given application (*e.g.*, engine family) into an accelerated aging cycle for that given application, as well as methods for carrying out reactor or engine accelerated aging using that cycle. While this testing can be carried out on an engine as well as reactor bench, the engine option should not be confused with standard engine dynamometer aging out to useful life or the historic fuel-based engine dynamometer accelerated aging typically done out to 35 percent of useful life approach that EPA will no longer allow under this final rule. The engine option in this procedure uses the engine (1) as a source of accelerated sulfur from the combusted fuel, (2) as a source for exhaust gas, and (3) to generate heat. The catalyst poisoning agents (oil and sulfur) as well as the temperature exposure are the same between the two methods and the DARAP test program

data corroborates this. This protocol is intended to be representative of field aging, includes exposure to elements of both thermal and chemical aging, and is designed to achieve an acceleration of aging that is ten times a dynamometer or field test (1,000 hours of accelerated aging would be equivalent to 10,000 hours of standard aging).

The initial step in the method requires the gathering and analysis of input field data that represent a greater than average exposure to potential field aging factors. The field aging factors consist of thermal, oil, and sulfur exposure. The thermal exposure is based on the average exhaust temperature; however, if the engine family incorporates a periodic infrequent regeneration event that involves exposure to higher temperatures than are observed during normal (non-regeneration) operation, then this temperature is used. Oil exposure is based on field and laboratory measurements to determine an average rate of oil consumption in grams per hour that reaches the exhaust. Sulfur exposure is based on the sum of fuel- and oil-related sulfur consumption rates for the engine family. The procedure provides details on how to gather data from field vehicles to support the generation and analysis of the field data.

Next, the method requires determination of key components for aging. Most diesel aftertreatment systems contain multiple catalysts, each with their own aging characteristics. This accelerated aging procedure ages the system, not component-by-component. Therefore, it is necessary to determine which catalyst components are the key components that will be used for deriving and scaling the aging cycle. This includes identification of the primary and secondary catalysts in the aftertreatment system, where the primary is the catalyst that is directly responsible for most of the NO<sub>x</sub> reduction, such as a urea SCR catalyst in a compression-ignition aftertreatment system. The secondary is the catalyst that is intended to either alter exhaust characteristics or generate elevated temperature upstream of the primary catalyst, such as a DOC placed upstream of an SCR catalyst, with or without a DPF in between.

The next step in the process is to determine the thermal deactivation rate constant(s) for each key component. This is used for the thermal heat load calculation in the accelerated aging protocol. The calculations for thermal degradation are based on the use of an Arrhenius rate law function to model cumulative thermal degradation due to

heat exposure. The process of determining the thermal deactivation rate constant begins with determining what catalyst characteristic will be tracked as the basis for measuring thermal deactivation. Generally, ammonia storage is the key aging metric for zeolite-based SCR catalysts, NO<sub>x</sub> reduction efficiency at low temperature for vanadium-based SCR catalysts, conversion rate of NO to NO<sub>2</sub> for DOCs with a downstream SCR catalyst, and HC reduction efficiency (as measured using ethylene) at 200 °C for DOCs where the aftertreatment system does not contain an SCR catalyst for NO<sub>x</sub> reduction. Thermal degradation experiments are then carried out over at least three different temperatures that accelerate thermal deactivation such that measurable changes in the aging metric can be observed at multiple time points over the course of no more than 50 hours. During these experiments it is important to avoid temperatures that are too high to prevent rapid catalyst failure by a mechanism that does not represent normal aging.

Generation of the accelerated aging cycle for a given application involves analysis of the field data to determine a set of aging modes that will represent that field operation. There are two methods of cycle generation in 40 CFR 1065.1139, each of which is described separately. Method 1 involves the direct application of field data and is used when the recorded data includes sufficient exhaust flow and temperature data to allow for determination of aging conditions directly from the field data set. Method 2 is meant to be used when insufficient flow and temperature data is available from the field data. In Method 2, the field data is used to weight a set of modes derived from the laboratory certification cycles for a given application. These weighted modes are then combined with laboratory recorded flow and temperatures on the certification cycles to derive aging modes. There are two different cases to consider for aging cycle generation, depending on whether or not a given aftertreatment system incorporates the use of a periodic regeneration event. For the purposes of cycle generation, a regeneration is any event where the operating temperature of some part of the aftertreatment system is raised beyond levels that are observed during normal (non-regeneration) operation. The analysis of regeneration data is considered separately from normal operating data.

The process of cycle generation begins with the determination of the number of bench aging hours. The input into this calculation is the number of real or field

<sup>388</sup> Memorandum to Docket EPA-HQ-OAR-2019-0055: "Diesel Aftertreatment Rapid Aging Program". George Mitchell. May 5, 2021.

<sup>389</sup> Sharp, C. (2022). Demonstration of Low NO<sub>x</sub> Technologies and Assessment of Low NO<sub>x</sub> Measurements in Support of EPA's 2027 Heavy Duty Rulemaking. Southwest Research Institute. Final Report EPA Contract 68HERC20D0014.

hours that represent the useful life for the target application. The target for the accelerated aging protocol is a 10-time acceleration of the aging process, therefore the total number of aging hours is set at service accumulation hours minus required engine dynamometer aging hours divided by 10. The hours will then be among different operating modes that will be arranged to result in repetitive temperature cycling over that period. For systems that incorporate periodic regeneration, the total duration will be split between regeneration and normal (non-regeneration) operation. The analysis of the operation data develops a reduced set of aging modes that represent normal operation using either Method 1 or Method 2. Method 1 is a direct clustering method and involves three steps: Clustering analysis, mode consolidation, and cycle building.<sup>390</sup> This method is used when sufficient exhaust flow and temperature data are available directly from the field data. Method 2 is a cluster-based weighting of certification cycle modes when there is insufficient exhaust flow and temperature data from the field at the time the cycle is being developed. The initial candidate mode conditions are temperature and flow rate combinations that are the centroids from the analysis of each cluster.

The target for accelerated aging cycle operation is to run all the regenerations that would be expected over the course of useful life and the procedure provides a process for determining a representative regeneration profile that will be used during aging. Heat load calculation and cycle tuning are performed after the preliminary cycles have been developed for both normal and regeneration operation. The target cumulative deactivation is determined from the input field data, and then a similar calculation is performed for the preliminary aging cycle. If the cumulative deactivation for the preliminary cycle does not match cumulative deactivation from the field data, then the cycle is tuned over a series of steps described in 40 CFR 1065.1139 until the target is matched.

The final assembly of the candidate accelerated aging cycle involves the assembly of the target modes into a schedule of modes laid out on a time basis that can be repeated until the target number of aging hours has been reached. For cycles that incorporate

periodic regeneration modes, the regeneration frequency and duration, including any regeneration extension added to reach thermal targets, will be used to determine the length of the overall cycle. The number of these cycles that is run is equal to the total number of regenerations over full useful life. The duration of each cycle is total number of accelerated aging hours divided by the total number of regenerations. For multiple components with differing regeneration schedules, this calculation is performed using the component with the fewest total number of regenerations. The regeneration events for the more frequently regenerating components should be spaced evenly throughout each cycle to achieve the appropriate regeneration frequency and duration.

The regeneration duration (including extension) is then subtracted from the base cycle duration to calculate the duration of normal (non-regeneration) operation in seconds. This time is split among the normal (non-regeneration) modes in proportion to the overall target aging time in each mode. These modes are then split and arranged to achieve the maximum thermal cycling between high and low temperatures. No mode may have a duration shorter than 900 seconds, not including transition time. Mode transitions must be at least 60 seconds long and must be no longer than 300 seconds. The transition period is considered complete when you are within 5 °C of the target temperature for the primary key component. For modes longer than 1800 seconds, you may count the transition time as time in mode. For modes shorter than 1800 seconds, under the procedure you must not count the transition time as time in mode. Modes are arranged in alternating order starting with the lowest temperature mode and proceeding to the highest temperature mode, followed by the next lowest temperature mode, and so forth.

The final cycle is expressed as a schedule of target temperature, exhaust flow rate, and NO<sub>x</sub>. For a burner-based platform with independent control of these parameters, this cycle can be used directly. For an engine-based platform, it is necessary to develop a schedule of speed and load targets that will produce the target exhaust conditions based on the capabilities of the engine platform.

The accelerated oil consumption target is calculated at 10 times the field average oil consumption that was determined from the field data and/or laboratory measurements. Under the procedure, this oil consumption rate must be achieved on average over the aging cycle, and it must at least be

performed during all non-regeneration modes. Under the procedure, the lubricating oil chosen must meet the normal in-use specifications and it cannot be altered. The oil is introduced by two pathways, a bulk pathway and a volatile pathway. The bulk pathway involves introduction of oil in a manner that represents oil passing the piston rings, and the volatile pathway involves adding small amount of lubricating oil to the fuel. Under the procedure, the oil introduced by the volatile pathway must be between 10 percent and 30 percent of the total accelerated oil consumption.

Sulfur exposure related to oil is already taken care of via acceleration of the oil consumption itself. The target cumulative fuel sulfur exposure is calculated using the field recorded average fuel rate data and total field hours assuming a 10-ppm fuel sulfur level (which was determined as the 90th percentile of available fuel survey data).

For an engine-based accelerated aging platform where the engine is used as the exhaust gas source, accelerated fuel sulfur is introduced by increasing the fuel sulfur level. The cycle average fuel rate over the final aging cycle is determined once that target modes have been converted into an engine speed and load schedule. The target aging fuel sulfur level that results in reaching the target cumulative fuel sulfur exposure is determined from the field data using the aging cycle average fuel rate and the total number of accelerated aging hours.

For a burner-based platform, accelerated fuel sulfur is introduced directly as gaseous SO<sub>2</sub>. Under the procedure, the SO<sub>2</sub> must be introduced in a manner that does not impede any burner combustion, and only in a location that represents the exhaust conditions entering the aftertreatment system. Under the procedure, the mass rate of sulfur that must be introduced on a cycle average basis to reach the target cumulative fuel sulfur exposure from the field data is determined after the final aging cycle has been generated.

The accelerated aging protocol is run on a bench aging platform that includes features necessary to successfully achieve accelerated aging of thermal and chemical aging factors. This aging bench can be built around either an engine or a burner as the core heat generating element. The requirements for both kinds of bench aging platform are described in the following paragraphs.

The engine-based accelerated aging platform is built around the use of a diesel engine for generation of heat and flow. The engine used does not need to be the same engine as the application that is being aged. Any diesel engine can be used, and the engine may be

<sup>390</sup> [https://documentation.sas.com/doc/en/emref/14.3/n1dm4owbc3ka5jn11yjkod7ov1va.htm#:-:text=The%20cubic%20clustering%20criterion%20\(CCC,evaluated%20by%20Monte%20Carlo%20methods.](https://documentation.sas.com/doc/en/emref/14.3/n1dm4owbc3ka5jn11yjkod7ov1va.htm#:-:text=The%20cubic%20clustering%20criterion%20(CCC,evaluated%20by%20Monte%20Carlo%20methods.)

modified as needed to support meeting the aging procedure requirements. You may use the same bench aging engine for deterioration factor determination from multiple engine families. The engine must be capable of reaching the combination of temperature, flow, NO<sub>x</sub>, and oil consumption targets required. Using an engine platform larger than the target application for a given aftertreatment system can provide more flexibility to achieve the target conditions and oil consumption rates.

To increase the range of flexibility of the bench aging engine platform, the test cell setup should include additional elements to allow more independent control of exhaust temperature and flow than would be available from the engine alone. For example, exhaust heat exchangers and/or the use of cooled and uncooled exhaust pipe can be useful to provide needed flexibility. When using heat exchangers under this procedure, you must ensure that you avoid condensation in any part of the exhaust system prior to the aftertreatment. You can also control engine parameters and the calibration on the engine to achieve additional flexibility needed to reach the target exhaust conditions.

Under this procedure, oil consumption must be increased from normal levels to reach the target of 10 times oil consumption. As noted earlier, oil must be introduced through a combination of a bulk pathway, which represents the majority of oil consumption past the piston rings, and a volatile pathway, which is achieved by adding small amounts of lube oil to the fuel. The total oil exposure via the volatile pathway must be between 10 percent and 30 percent of the total accelerated oil consumption. Under this procedure, the remainder of the oil consumption must be introduced via the bulk pathway. The volatile portion of the oil consumption should be introduced and monitored continuously via a mass flow meter or controller.

Under this procedure, the engine will need to be modified to increase oil consumption via the bulk pathway. This increase is generally achieved through a combination of engine modifications and the selection of aging speed/load combinations that will result in increased oil consumption rates. To achieve this, you may modify the engine in a fashion that will increase oil consumption in a manner such that the oil consumption is still generally representative of oil passing the piston rings into the cylinder. Inversion of the top compression rings as a method which has been used to increase oil consumption successfully for the DAAAC aging program at SwRI. A

secondary method that has been used in combination with the primary method involves the modification of the oil control rings in one or more cylinders to create small notches or gaps (usually no more than two per cylinder) in the top portion of the oil control rings that contact the cylinder liner (care must be taken to avoid compromising the structural integrity of the ring itself).

Under this procedure, oil consumption for the engine-based platform must be tracked at least periodically via a drain and weigh process, to ensure that the proper amount of oil consumption has been achieved. It is recommended that the test stand include a constant volume oil system with a sufficiently large oil reservoir to avoid oil "top-offs" between oil change intervals. Under this procedure, periodic oil changes will be necessary on any engine platform, and it is recommended that the engine be run for at least 72 hours following an oil change with engine exhaust not flowing through the aftertreatment system to stabilize oil consumption behavior before resuming aging. A secondary method for tracking oil consumption is to use clean DPF weights to track ash loading, and compare this mass of ash to the amount predicted using the measured oil consumption mass and the oil ash concentration. The mass of ash found by DPF weight should fall within a range of 55 percent to 70 percent of the mass predicted from oil consumption measurements.

The engine should also include a means of introducing supplemental fuel to the exhaust to support regeneration if regeneration events are part of the aging. This can be done either via post-injection from the engine or using in-exhaust injection. The method and location of supplemental fuel introduction should be representative of the approach used on the target application, but manufacturers may adjust this methodology as needed on the engine-based aging platform to achieve the target regeneration temperature conditions.

The burner-based aging platform is built around a fuel-fired burner as the primary heat generation mechanism. For the accelerated aging application under this procedure, the burner must utilize diesel fuel and it must produce a lean exhaust gas mixture. Under this procedure, the burner must have the ability to control temperature, exhaust flow rate, NO<sub>x</sub>, oxygen, and water to produce a representative exhaust mixture that meets the accelerated aging cycle targets for the aftertreatment system to be aged. Under this procedure, the burner must include a

means to monitor these constituents in real time, except in the case of water where the system's water metering may be verified via measurements made prior to the start of aging (such as with an FTIR) and should be checked periodically by the same method. Under this procedure, the accelerated aging cycle for burner-based aging must also include representative mode targets for oxygen and water, because these will not necessarily be met by the burner itself through combustion. As a result, for this procedure the burner will need features to allow the addition of water and the displacement of oxygen to reach representative target levels of both. During non-regeneration modes, it is recommended that the burner be operated in a manner to generate a small amount of soot to facilitate proper ash distribution in the DPF system.

The burner-based platform requires methods for oil introduction for both the bulk pathway and the volatile pathway. For the bulk pathway, manufacturers may implement a method that introduces lubricating oil in a region of the burner that does not result in complete combustion of the oil, but at the same time is hot enough to oxidize oil and oil additives in a manner similar to what occurs when oil enters the cylinder of an engine past the piston rings. Care must be taken to ensure the oil is properly atomized and mixed into the post-combustion burner gases before they have cooled to normal exhaust temperatures, to insure proper digestion and oxidation of the oil constituents. The volatile pathway oil is mixed into the burner fuel supply and combusted in the burner. As noted earlier, under this procedure total oil exposure via the volatile pathway must be between 10 percent and 30 percent of the total accelerated oil consumption. The consumption of oil in both pathways should be monitored continuously via mass flow meters or controllers. A secondary method of tracking oil consumption is to use clean DPF weights to track ash loading and compare this mass of ash to the amount predicted using the measured oil consumption mass and the oil ash concentration. The mass of ash found by DPF weight should fall within a range of 55 percent to 70 percent of the mass predicted from oil consumption measurements. This will also ensure that injected oil mass is actually done in a representative manner so that it reaches the aftertreatment system.

Under this procedure, the burner-based platform will also need a method to introduce and mix gaseous SO<sub>2</sub> to achieve the accelerated sulfur targets. Under this procedure, the consumption

of SO<sub>2</sub> must be monitored continuously via a mass flow meter or controller. SO<sub>2</sub> does not need to be injected during regeneration modes.

The burner-based platform should also include a means of introducing supplemental fuel to the exhaust to support regeneration if regeneration events are part of the aging. We recommend that the method and location of supplemental fuel introduction be representative of the approach used on the target application, but manufacturers may adjust this methodology as needed on the bench engine platform to achieve the target regeneration temperature conditions. For example, to simulate post-injected fuel we recommend to introduce the supplemental fuel into the post-combustion burner gases to achieve partial oxidation that will produce more light and partially oxidized hydrocarbons similar to post-injection.

There are specific requirements for the implementation, running, and validation of an accelerated aging cycle developed using the processes described in this section. Some of these requirements are common to both engine-based and burner-based platforms, but others are specific to one platform type or the other.

We recommended carrying out one or more practice aging cycles to help tune the cycle and aging platform to meet the cycle requirements. These runs can be considered part of the de-greening of test parts, or these can be conducted on a separate aftertreatment.

The final target cycle is used to calculate a cumulative target deactivation for key aftertreatment components. Manufacturers must also generate a cumulative deactivation target line describing the linear relationship between aging hours and cumulative deactivation. The temperature of all key components is monitored during the actual aging test and the actual cumulative deactivation based on actual recorded temperatures is calculated. The cumulative deactivation must be maintained to within 3 percent of the target line over the course of the aging run and if you are exceeding these limits, you must adjust the aging stand parameters to ensure that you remain within these limits. Under this procedure, you must stay within these limits for all primary key components. It should be noted that any adjustments made may require adjustment of the heat rejection through the system if you are seeing different behavior than the target cycle suggests based on the field data. If you are unable to meet this requirement for any tracked secondary system (for example for a

DOC where the SCR is the primary component), you may instead track the aging metric directly and show that you are within 3 percent of the target aging metric. Note that this is more likely to occur when there is a large difference between the thermal reactivity coefficients of different components.

Calculate a target line for oil accumulation and sulfur accumulation showing a linear relationship between aging hours and the cumulative oil exposure on a mass basis. Under this procedure, you must stay within  $\pm 10$  percent of this target line for oil accumulation, and within  $\pm 5$  percent of this target line for sulfur accumulation. In the case of engine-based bulk oil accumulation you will only be able to track this based on periodic drain and weigh measurements. For all other chemical aging components, track exposure based on the continuous data from the mass flow meters for these chemical components. If your system includes a DPF, it is recommended that you implement the secondary tracking of oil consumption using DPF ash loading measurements as describe earlier.

For the engine-based platform, it will be necessary under this procedure to develop a schedule of engine operating modes that achieve the combined temperature, flow, and oil consumption targets. You may deviate from target NO<sub>x</sub> levels as needed to achieve these other targets, but we recommend that you maintain a NO<sub>x</sub> level representative of the target application or higher on a cycle average basis. Note that the need to operate at modes that can reach the target oil consumption will leverage the flexibility of the engine stand, and you may need to iterate on the accelerated oil consumption modifications to achieve a final target configuration. You may need to adjust the cycle or modify the oil consumption acceleration to stay within the  $\pm 10$  percent target. In the even that you find that actual fuel consumption varies from original assumptions, you may need to adjust the doped fuel sulfur level periodically to maintain the sulfur exposure within the  $\pm 5$  percent limit.

If the application uses DEF, it must be introduced to the exhaust stream in a manner that represents the target application. You may use hardware that is not identical to the production hardware but ensure that hardware produces representative performance. Similarly, you may use hardware that is not identical to production hardware for fuel introduction into the exhaust as long you ensure that the performance is representative.

Under this procedure, for the burner-based platform, you will be able to directly implement the temperature, flow, NO<sub>x</sub>, sulfur, and oil consumption targets. You will also need to implement water and O<sub>2</sub> targets to reach levels representative of diesel exhaust. We recommend that you monitor and adjust oil and sulfur dosing on a continuous basis to stay within targets. You must verify the performance of the oil exposure system via the secondary tracking of oil exposure via DPF ash loading and weighing measurements. This will ensure that your oil introduction system is functioning correctly. If you use a reductant, such as DEF, for NO<sub>x</sub> reduction, use good engineering judgement to introduce DEF in a manner that represents the target application. You may use hardware that is not identical to the production hardware but ensure that the hardware produces representative performance. Similarly, you may use hardware that is not identical to production hardware for fuel introduction into the exhaust as long you ensure that the performance is representative.

The implementation and carrying out of these procedures will enable acceleration of the deterioration factor determination testing, and generally allow the determination of the deterioration factor out to useful life, over 90 days of testing.

#### *G. Averaging, Banking, and Trading*

EPA is finalizing an averaging, banking, and trading (ABT) program for heavy-duty engines that provides manufacturers with flexibility in their product planning while encouraging the early introduction of emissions control technologies and maintaining the expected emissions reductions from the program. Several core aspects of the ABT program we are finalizing are consistent with the proposed ABT program, but the final ABT program includes several updates after consideration of public comments. In particular, EPA requested comment on and agrees with commenters that a lower family emission limit (FEL) cap than proposed is appropriate for the final rule. Further, after consideration of public comments, EPA is not finalizing at this time the proposed Early Adoption Incentives program, and in turn we are not including emissions credit multipliers in the final program. Rather, we are finalizing an updated version of the proposed transitional credit program under the ABT program. As described in preamble Section IV.G.7, the revised transitional credit program that we are finalizing provides four pathways to generate straight NO<sub>x</sub>

emissions credits (*i.e.*, no credit multipliers) that are valued based on the extent to which the engines generating credits comply with the requirements we are finalizing for MY 2027 and later (*e.g.*, credits discounted at a rate of 40 percent for engines meeting a lower numeric standard but none of the other MY 2027 and later requirements) (see section 12 of the Response to Comments document and preamble Section IV.G.7 for more details). In addition, we are finalizing a production volume allowance for MYs 2027 through 2029 that is consistent with the proposal but different in several key aspects, including that manufacturers will be required to use NO<sub>x</sub> emissions credits to certify heavy heavy-duty engines compliant with MY 2010 requirements in MYs 2027 through 2029 (see Section IV.G.9 for details). Finally, we are not finalizing the proposed allowance for manufacturers to generate NO<sub>x</sub> emissions credits from heavy-duty zero emissions vehicles (ZEVs) (see Section IV.G.10).

Consistent with the proposed ABT program, the final ABT program will maintain several aspects of the ABT program currently specified in 40 CFR 86.007–15, including:

- Allowing ABT of NO<sub>x</sub> credits with no expiration of the ABT program,
- calculating NO<sub>x</sub> credits based on a single NO<sub>x</sub> FEL for an engine family,
- specifying FELs to the same number of decimal places as the applicable standards, and
- calculating credits based on the work and miles of the FTP cycle.

In this Section we briefly describe the proposed ABT program, the comments received on the proposed ABT program, and EPA's response to those comments. Subsequent subsections provide additional details on the restrictions we are finalizing for using emission credits in model years 2027 and later, such as averaging sets (Section IV.G.2), FEL caps (Section IV.G.4), and limited credit life (Section IV.G.4). See the proposed rule preamble (87 FR 17550, March 28, 2022) for additional discussion on the proposed ABT program and the history of ABT for heavy-duty engines.

The proposed ABT program allowed averaging, banking, and trading of NO<sub>x</sub> credits generated against applicable heavy-duty engine NO<sub>x</sub> standards, while discontinuing a credit program for HC and PM. We also proposed new provisions to clarify how FELs apply for additional duty cycles. The proposed program included restrictions to limit the production of new engines with higher emissions than the standards; these restrictions included FEL caps, credit life for credits generated for use

in MYs 2027 and later, and the expiration of currently banked credits. These provisions were included in proposed 40 CFR part 1036, subpart H, and 40 CFR 1036.104(c). In addition, we proposed interim provisions in 40 CFR 1036.150(a)(1) describing how manufacturers could generate credits in MY 2024 through 2026 to apply in MYs 2027 and later. We requested comment on several aspects of the proposed ABT program that we are updating in the final rule, including the transitional credit program and level of the FEL cap, which restrict the use of credits in MY 2027 and later.

Many commenters provided perspectives on the proposed ABT program. The majority of commenters supported the proposed ABT program, although several suggested adjustments for EPA to consider in the final rule. In contrast, a number of commenters opposed the proposed ABT program and argued that EPA should eliminate the NO<sub>x</sub> ABT program in the final rule. Perspectives from commenters supporting and opposing the proposed ABT program are briefly summarized in this section with additional details in section 12 of the Response to Comments document.

Commenters supporting the ABT program stated that it provides an important flexibility to manufacturers for product planning during a transition to more stringent standards. They further stated that a NO<sub>x</sub> ABT program would allow manufacturers to continue offering a complete portfolio of products, while still providing real NO<sub>x</sub> emissions reductions. In contrast, commenters opposing the ABT program argued EPA should eliminate the NO<sub>x</sub> ABT program in order to maximize NO<sub>x</sub> emissions reductions nationwide, particularly in environmental justice communities and other areas impacted by freight industry. These commenters stated that the NO<sub>x</sub> standards are feasible without the use of credits, and that eliminating the credit flexibilities of an ABT program would be most consistent with EPA's legal obligations under the CAA.

EPA agrees with those commenters who support a well-designed ABT program as a way to help us meet our emission reduction goals at a faster pace while providing flexibilities to manufacturers to meet new, more stringent emission standards. For example, averaging, banking, and trading can result in emissions reductions by encouraging the development and use of new and improved emission control technology, which results in lower emissions. The introduction of new emission control

technologies can occur either in model years prior to the introduction of new standards, or during periods when there is no change in emissions standards but manufacturers still find it useful to generate credits for their overall product planning. In either case, allowing banking and trading can result in emissions reductions earlier in time, which leads to greater public health benefits sooner than would otherwise occur; benefits realized sooner in time are generally worth more to society than those deferred to a later time.<sup>391</sup> These public health benefits are further ensured through the use of restrictions on how and when credits may be used (*e.g.*, averaging sets, credit life), which are discussed further in this Section IV.G. For manufacturers, averaging, banking, and trading provides additional flexibility in their product planning by providing additional lead time before all of their engine families must comply with all the new requirements without the use of credits. For periods when no changes in emission standards are involved, banking can provide manufacturers additional flexibility, provide assurance against any unforeseen emissions-related problems that may arise, and in general provide a means to encourage the development and introduction of new engine technology (see 55 FR 30585, July 26, 1990, for additional discussion on potential benefits of an ABT program).

While EPA also agrees with those commenters stating that the standards in the final rule are feasible without the use of credits, as described in Section III of this preamble, given the technology-forcing nature of the final standards we disagree that providing an optional compliance pathway through the final rule's ABT program is inconsistent with requirements under CAA section 202(a)(3)(A).<sup>392</sup> The final ABT program appropriately balances flexibilities for manufacturers to generate NO<sub>x</sub>

<sup>391</sup> Consistent with economic theory, we assume that people generally prefer present to future consumption. We refer to this as the time value of money, which means money received in the future is not worth as much as an equal amount received today. This time preference also applies to emissions reductions that result in the health benefits that accrue from regulation. People have been observed to prefer health gains that occur immediately to identical health gains that occur in the future. Health benefits realized in the near term are therefore worth more to society than those deferred to a later time.

<sup>392</sup> See *NRDC v. Thomas*, 805 F. 2d 410, 425 (D.C. Cir. 1986), which upheld emissions averaging after concluding that "EPA's argument that averaging will allow manufacturers more flexibility in cost allocation while ensuring that a manufacturer's overall fleet still meets the emissions reduction standards makes sense".

emissions credits with updated final restrictions (e.g., credit life, averaging sets, and family emissions limit (FEL) caps) that in our judgement both ensure that available emissions control technologies are adopted and maintain the emissions reductions expected from the final standards.<sup>393</sup> An ABT program is also an important foundation for targeted incentives to encourage manufacturers to adopt advanced technology before required compliance dates, which we discuss further in preamble Section IV.G.7 and Section 12 of the Response to Comments document.

One commenter opposing EPA's proposed NO<sub>x</sub> emissions ABT program provided analyses for EPA to consider in developing the final rule. EPA has evaluated the three approaches to generating credits in the commenter's analysis: (1) Engines certified below today's standards which qualify for the proposed transitional credit program, (2) engines certified to the CARB Omnibus standards which would qualify for the proposed transitional program or on average achieve a standard below Federal requirements, and (3) ZEVs. For the first category (the transitional credit program), we considered several factors when designing the final transitional credit program that are more fully described in preamble Section IV.G.7; briefly, the transitional credit program we are finalizing will discount the credits manufacturers generated from engines certified to levels below today's standards unless manufacturers can meet all of the requirements in the final MY 2027 and later standards. This includes meeting standards such as the final low load cycle (LLC), which requires demonstration of emissions control in additional engine operations (i.e., low load) compared to today's test cycles. For the second category in the commenter's analysis (engines certified to Omnibus standards), we recognize that our proposed rule preamble may have been unclear regarding how the existing regulations in part 86 and part 1036 apply for purposes of participation in the Federal ABT program to engines that are certified to state standards that are different than the Federal standards. We proposed to migrate without substantive modification the definition of "U.S.-directed production" in 40 CFR 86.004-2 to 40 CFR part 1036.801 for

<sup>393</sup> As discussed in Section IV.G.9, we are finalizing an allowance for manufacturers to continue to produce a small number (5 percent of production volume) of engines that meet the current standards for a few model years (i.e., through MY 2030). See Section IV.G.9 for details on our approach and rationale for including this allowance in the final rule.

criteria pollutant engine requirements, to match the existing definition for GHG engine requirements, which excludes engines certified to state emission standards that are different than the Federal standards.<sup>394</sup> The relevant existing NO<sub>x</sub> ABT credit program requirements, and the relevant program requirements we are finalizing as proposed, specify that compliance through ABT does not allow credit calculations to include engines excluded from the definition of U.S.-directed production volume.<sup>395</sup> For the third category in the commenter's analysis (ZEVs), as discussed in preamble Section IV.G.10 and section 12 of the Response to Comments document, we are not finalizing the proposed allowance for manufacturers to generate NO<sub>x</sub> credits from ZEVs. For these reasons, EPA believes the final ABT program will at a minimum maintain the emissions reductions projected from the final rule, and in fact could result in greater public health benefits by resulting in emissions reductions earlier in time than they would occur without banking or trading. Further, if manufacturers generate NO<sub>x</sub> emissions credits that they do not subsequently use (e.g., due to transitioning product lines to ZEVs), then the early emissions reductions from generating these credits will result in more emission reductions than our current estimates reflect. In addition, the final ABT program provides an important flexibility for manufacturers, which we expect will help to ensure a smooth transition to the new standards and avoid delayed emissions reductions due to slower fleet turnover than may occur without the flexibility of the final ABT program.

In the subsections that follow we briefly summarize and provide responses to comments on several more specific topics, including: ABT for pollutants other than NO<sub>x</sub> (IV.G.1), Applying the ABT provisions to multiple NO<sub>x</sub> duty-cycle standards (IV.G.2), Averaging Sets (IV.G.3), FEL

<sup>394</sup> See Section XI.B.4 for additional information.

<sup>395</sup> See final part 1036, subpart H. Existing 40 CFR 1036.705(c) states the following, which we are finalizing as proposed as also applicable to NO<sub>x</sub> ABT: "As described in § 1036.730, compliance with the requirements of this subpart is determined at the end of the model year based on actual U.S.-directed production volumes. Keep appropriate records to document these production volumes. Do not include any of the following engines to calculate emission credits: . . . (4) Any other engines if we indicate elsewhere in this part 1036 that they are not to be included in the calculations of this subpart." See also existing 40 CFR 86.007-15 (regarding U.S.-directed production engines for the purpose of using or generating credits during a phase-in of new standards) and 66 FR 5114, January 18, 2001.

caps (IV.G.4), Credit Life (IV.G.5), Existing credits (IV.G.6), Transitional Credits (IV.G.7), the proposed Early Adoption Incentives (IV.G.8), and a Production Volume Allowance under ABT (IV.G.9). The final ABT program is specified in 40 CFR part 1036, subpart H.<sup>396</sup> Consistent with the proposal, we are also finalizing a new paragraph at 40 CFR 1036.104(c) to specify how the ABT provisions will apply for MY 2027 and later heavy-duty engines subject to the final criteria pollutant standards in 40 CFR 1036.104(a). The Transitional Credit program in the final rule is described in the interim provision in 40 CFR 1036.150(a)(1), which we are finalizing with revisions from the proposal.

#### 1. ABT for Pollutants Other Than NO<sub>x</sub>

After consideration of public comments, EPA is choosing to finalize as proposed an ABT program that will not allow averaging, banking, or trading for HC (including NO<sub>x</sub>+NMHC) or PM for MY 2027 and later engines. This includes not allowing HC and PM emissions credits from prior model years to be used for MY 2027 and later engines. For engines certified to MY 2027 or later standards, manufacturers must demonstrate in their application for certification that they meet the final PM, HC, and CO emission standards in 40 CFR 1036.104(a) without using emission credits.

Several commenters supported EPA's proposal to discontinue ABT for HC and PM. These commenters stated that current heavy-duty engine technologies can easily meet the proposed HC and PM standards, and therefore an ABT program for these pollutants is not necessary. Some commenters urged EPA to provide ABT programs for HC and CO based on the stringency of the standards for these pollutants, particularly for Spark-ignition HDE. Another commenter did not indicate support or opposition to an HC ABT flexibility in general, but stated that EPA should not base the final HC standard on the use of HC emissions credits since doing so could lead to competitive disruptions between SI engine manufacturers. One commenter also urged EPA to consider ABT programs for regulated pollutant emissions other than NO<sub>x</sub>, including HC, PM, CO, and N<sub>2</sub>O.

As discussed in preamble Section III, EPA demonstrated that the final standards for NO<sub>x</sub>, HC, CO, and PM area feasible for all engine classes, and we

<sup>396</sup> As proposed, the final rule does not include substantive revisions to the existing GHG provisions in 40 CFR 1036, subpart H; as proposed, the final revisions clarify whether paragraphs apply for criteria pollutant standards or GHG standards.

set the numeric values without assuming manufacturers would require the use of credits to comply. We proposed to retain and revise the NO<sub>x</sub> ABT program and we are updating from our proposal in this final rule as described in the following sections.

For PM, manufacturers are submitting certification data to the agency for current production engines well below the final PM standard over the FTP duty cycle; the final standard ensures that future engines will maintain the low level of PM emissions of the current engines. Manufacturers are not using PM credits to certify today and we received no new data showing manufacturers would generate or use PM credits starting in MY 2027; therefore, we are finalizing as proposed.

We disagree with commenters indicating that credits will be needed for Spark-ignition HDE to meet the final HC and CO standards. Our SI engine demonstration program data show feasibility of the final standards (see preamble Section III.D for details). Furthermore, as described in Section IV.G.3, we are retaining the current ABT provisions that restrict credit use to within averaging sets and we expect SI engine manufacturers, who have few heavy-duty engine families, will have limited ability to generate and use credits. See preamble Section III.D for a discussion of the final numeric levels of the Spark-ignition HDE standards and adjustments we made to the proposed HC and CO stringencies after further consideration.

We did not propose or request comment on expanding the heavy-duty engine ABT program to include other regulated pollutant emissions, such as N<sub>2</sub>O, and thus are not including additional pollutants in the final ABT program.

## 2. Multiple Standards and Duty Cycles for NO<sub>x</sub> ABT

Under the current and final ABT provisions, FELs serve as the emission standards for the engine family for compliance testing purposes.<sup>397</sup> We are finalizing as proposed new provisions to ensure the NO<sub>x</sub> emission performance over the FTP is proportionally reflected in the range of cycles included in the final rule for heavy-duty engines.<sup>398</sup> Specifically, manufacturers will declare

a FEL to apply for the FTP standards and then they will calculate a NO<sub>x</sub> FEL for the other applicable cycles by applying an adjustment factor based on their declared FEL<sub>FTP</sub>. As proposed, the adjustment factor in the final rule is a ratio of the declared NO<sub>x</sub> FEL<sub>FTP</sub> to the FTP NO<sub>x</sub> standard to scale the NO<sub>x</sub> FEL of the other duty cycle or off-cycle standards.<sup>399</sup> For example, if a manufacturer declares an FEL<sub>FTP</sub> of 25 mg NO<sub>x</sub>/hp-hr in MY 2027 for a Medium HDE, where the final NO<sub>x</sub> standard is 35 mg/hp-hr, a ratio of 25/35 or 0.71 will be applied to calculate a FEL to replace each NO<sub>x</sub> standard that applies for these engines in the proposed 40 CFR 1036.104(a). Specifically, for this example, a Medium HDE manufacturer would replace the full useful life standards for SET, LLC, and the three off-cycle bins with values that are 0.71 of the final standards. For an SI engine manufacturer that declares an FEL<sub>FTP</sub> of 15 mg NO<sub>x</sub>/hp-hr compared to the final MY 2027 standard of 35 mg/hp-hr, a ratio of 15/35 or 0.43 would be applied to the SET duty cycle standard to calculate an FEL<sub>SET</sub>. Note that an FEL<sub>FTP</sub> can also be higher than the NO<sub>x</sub> standard in an ABT program if it is offset by lower-emitting engines in an engine family that generates equivalent or more credits in the averaging set (see 40 CFR 1036.710). For a FEL higher than the NO<sub>x</sub> standard, the adjustment factor will proportionally increase the emission levels allowed when manufacturers demonstrate compliance over the other applicable cycles. Manufacturers are required to set the FEL for credit generation such that the engine family's measured emissions are at or below the respective FEL of all the duty-cycle and off-cycle standards. For instance, if a CI engine manufacturer demonstrates NO<sub>x</sub> emissions on the FTP that is 25 percent lower than the standard but can only achieve 10 percent lower NO<sub>x</sub> emissions for the low load cycle, the declared FEL could be no less than 10 percent below the FTP standard, to ensure the proportional FEL<sub>LLC</sub> would be met.

In the final program, manufacturers will include test results in the certification application to demonstrate

their engines meet the declared FEL values for all applicable duty cycles (see 40 CFR 1036.240(a), finalized as proposed). For off-cycle standards, we are also finalizing as proposed the requirement for manufacturers to demonstrate that all the CI engines in the engine family comply with the final off-cycle emission standards (or the corresponding FELs for the off-cycle bins) for all normal operation and use by describing in sufficient detail any relevant testing, engineering analysis, or other information (see 40 CFR 1036.205(p)). These same bin standards (or FELs) apply for the in-use testing provisions finalized in 40 CFR part 1036, subpart E, and for the PEM-based DF verification in the finalized 40 CFR 1036.246(b)(2), if applicable.<sup>400</sup> In addition, as discussed in Section III, we are finalizing a compliance margin for Heavy HDE to account for additional variability that can occur in-use over the useful life of HHDEs; the same 15 mg/hp-hr in-use compliance margin for HHDEs will be added to declared FELs when verifying in-use compliance for each of the duty-cycles (*i.e.*, compliance with duty-cycle standards once the engine has entered commerce) (see 40 CFR 1036.104(a)). Similarly, the same in-use compliance margin will be applied when verifying in-use compliance over off-cycle standards (see preamble Section III.C for discussion).

Once FEL values are established, credits are calculated based on the FTP duty cycle. We did not propose substantive revisions to the equation that applies for calculating emission credits in 40 CFR 1036.705, but we are finalizing, as proposed, to update the variable names and descriptions to apply for both GHG and criteria pollutant calculations.<sup>401</sup> In Equation IV-1, we reproduce the equation of 40 CFR 1036.705 to emphasize how the FTP duty cycle applies for NO<sub>x</sub> credits. Credits are calculated as megagrams (*i.e.*, metric tons) based on the emission rate over the FTP cycle. The emission credit calculation represents the emission impact that would occur if an engine operated over the FTP cycle for its full useful life. The difference between the FTP standard and the FEL is multiplied by a conversion factor that represents the average work performed

<sup>397</sup> The FELs serves as the emission standard for compliance testing instead of the standards specified in 40 CFR 1036.104(a); the manufacturer agrees to meet the FELs declared whenever the engine is tested over the applicable duty- or off-cycle test procedures.

<sup>398</sup> See the proposed rule preamble (87 FR 17550, March 28, 2022) for discussion on the relationship between the current FTP standards and other duty- or off-cycle standards.

<sup>399</sup> As proposed, we will require manufacturers to declare the NO<sub>x</sub> FEL for the FTP duty cycle in their application for certification. Manufacturers and EPA will calculate FELs for the other applicable cycles using the procedures specified in 40 CFR 1036.104(c)(3) to evaluate compliance with the other cycles; manufacturers will not be required to report the calculated FELs for the other applicable cycles. As noted previously, manufacturers will demonstrate they meet the standards for PM, CO, and HC and will not calculate or report FELs for those pollutants.

<sup>400</sup> We did not propose and are not finalizing off-cycle standards for SI engines; if EPA requests SI engine manufacturers to perform PEMS-based DF verification as set forth in the final 40 CFR 1036.246(b)(2), then the SI engine manufacturer would use their FEL to calculate the effective in-use standard for those procedures.

<sup>401</sup> The emission credits equations in the final 40 CFR 1036.705 and the current 40 CFR 86.007-15(c)(1)(i) are functionally the same.



over the FTP duty cycle to get the per-engine emission rate over the cycle. This value is then multiplied by the production volume of engines in the

engine family and the applicable useful life mileage. Credits are calculated at the end of the model year using actual U.S. production volumes for the engine

family. The credit calculations are submitted to EPA as part of a manufacturer's ABT report (see 40 CFR 1036.730).

#### Equation IV-1

$$NOx \text{ Emission Credit} = (Std_{FTP} - FEL) \cdot \frac{Work_{FTP}}{Miles_{FTP}} \cdot Volume \cdot UL \cdot (10^{-9})$$

Where:

Std<sub>FTP</sub> = the FTP duty cycle NO<sub>x</sub> emission standard, in mg/hp-hr, that applies for engines not participating in the ABT program

FEL = the engine family's FEL for NO<sub>x</sub>, in mg/hp-hr.

Work<sub>FTP</sub> = the total integrated horsepower-hour over the FTP duty cycle.

Miles<sub>FTP</sub> = the miles of the FTP duty cycle.

For Spark-ignition HDE, use 6.3 miles.  
For Light HDE, Medium HDE, and Heavy HDE, use 6.5 miles.

Volume = the number of engine eligible to participate in the ABT program within the given engine family during the model year, as described in 40 CFR 1036.705(c).

UL = the useful life for the standard that applies for a given engine family, in miles.

We did not receive specific comments on the proposed approach to calculate a NO<sub>x</sub> FEL for the other applicable cycles by applying an adjustment factor based on the declared FEL<sub>FTP</sub>. As such, we are finalizing the approach as proposed.

### 3. Averaging Sets

After consideration of public comments, we are finalizing, as proposed, to allow averaging, banking, and trading only within specified "averaging sets" for heavy-duty engine emission standards. Specifically, the final rule will use engine averaging sets that correspond to the four primary intended service classes,<sup>402</sup> namely:

- Spark-ignition HDE
- Light HDE
- Medium HDE
- Heavy HDE

Some commenters urged EPA to allow manufacturers to move credits between the current averaging sets (e.g., credits generated by medium heavy-duty engines could be used by heavy heavy-duty engines), while other commenters recommended that EPA finalize the proposal to maintain restrictions that do not allow movement of credits between the current averaging sets. Those supporting movement of credits between averaging sets stated that doing

so would reduce the likelihood that a manufacturer would develop two engines to address regulatory requirements when they could invest in only one engine if they were able to move credits between averaging sets; commenters also stated that restrictions on ABT decrease a manufacturer's ability to respond to changes in emissions standards. Those supporting the current restrictions that do not allow movement of credits between averaging sets stated that maintaining the averaging sets was important to avoid competitive disruptions between manufacturers.

EPA agrees that maintaining the current averaging sets is important to avoid competitive disruptions between manufacturers; this is consistent with our current and historical approach to avoid creating unfair competitive advantages or environmental risks due to credit inconsistency.<sup>403</sup> As described throughout this Section IV.G, we believe that the final ABT program, including this limitation, appropriately balances providing manufacturers with flexibility in their product planning, while maintaining the expected emissions reductions from the program. As we describe further in Section IV.G.7, we provide one exception to this limitation for one of the Transitional Credit pathways for reasons special to that program.<sup>404</sup>

### 4. FEL Caps

As proposed, the final ABT program includes Family Emissions Limit (FEL) caps; however, after further consideration, including consideration of public comments, we are choosing to finalize lower FEL caps than proposed. The FEL caps in the final rule are 65

mg/hp-hr for MY 2027 through 2030, and 50 mg/hp-hr for MY 2031 and later (see 40 CFR 1036.104(c)(2)). In this section, IV.G.4, we briefly summarize our proposed FEL caps, stakeholder comments on the proposed FEL caps, and then discuss EPA's responses to comments along with our rationale for the FEL caps in the final rule.

We proposed maximum NO<sub>x</sub> FEL<sub>FTP</sub> values of 150 mg/hp-hr under both proposed Option 1 (for model year 2027 through 2030), and proposed Option 2 (for model year 2027 and later). This value is consistent with the average NO<sub>x</sub> emission levels achieved by recently certified CI engines (see Chapter 3.1.2 of the RIA). We believed a cap based on the average NO<sub>x</sub> emission levels of recent engines would be more appropriate than a cap at the current standard of 0.2 g/hp-hr (200 mg/hp-hr), particularly when considering the potential for manufacturers to apply NO<sub>x</sub> credits generated from electric vehicles for the first time.<sup>405</sup> For MY 2031 and later under Option 1, we proposed a consistent 30 mg/hp-hr allowance for each primary intended service class added to each full useful life standard.

We requested comment on our proposed FEL caps, including our approach to base the cap for MY 2027 through 2030 under Option 1, or MY 2027 and later under Option 2, on the recent average NO<sub>x</sub> emission levels. We also requested comment on whether the NO<sub>x</sub> FEL<sub>FTP</sub> cap in MY 2027 should be set at a different value, ranging from the current Federal NO<sub>x</sub> standard of approximately 200 mg/hp-hr to the 50 mg/hp-hr standard in CARB's HD Omnibus rule starting in MY 2024.<sup>406 407</sup>

<sup>403</sup> 55 FR 30585, July 26, 1990, 66 FR 5002 January 18, 2001 and 81 FR 73478 October 25, 2016.

<sup>404</sup> As discussed in Section IV.G.7, one of the transitional credit pathways we are finalizing allows limited movement of discounted credits between a subset of averaging sets. The combination of discounting credits moved between averaging sets combined with the additional limitations included in this transitional pathway are intended to address the potential for competitive disadvantages or environmental risks from allowing credit movement between averaging sets.

<sup>405</sup> Note that the current g/hp-hr emission standards are rounded to two decimal places, which allow emission levels to be rounded down by as much as 5 mg/hp-hr (i.e., with rounding the current standard is 205 mg/hp-hr).

<sup>406</sup> California Air Resources Board, "California Exhaust Emission Standards and Test Procedures for 2004 and Subsequent Model Heavy-Duty Diesel Engines and Vehicles," August 27, 2020. <https://ww2.arb.ca.gov/sites/default/files/barcu/regact/2020/hdomnibuslownox/frob-1.pdf>, page 19. Last accessed September 8, 2022.

<sup>402</sup> Primary intended service class is defined in 40 CFR 1036.140, which is referenced in the current 40 CFR 86.004-2.

We further requested comment on the proposal to set MY 2031 NO<sub>x</sub> FEL caps at 30 mg/hp-hr above the full useful life standards under proposed Option 1. Finally, we requested comment on whether different FEL caps should be considered if we finalize standards other than those proposed (*i.e.*, within the range between the standards of proposed Options 1 and 2) (See 87 FR 17550, March 28, 2022, for additional discussion on our proposed FEL caps and historical perspective on FEL caps).

Several commenters provided perspectives on the proposed FEL caps. All commenters urged EPA to finalize a lower FEL cap than proposed; there was broad agreement that the FEL cap in the final rule should be 100 mg/hp-hr or lower.

One commenter stated that a FEL cap at the level of the current standard would not meet the CAA 202(a)(3)(A) requirement to set “standards which reflect the greatest degree of emission reduction achievable through the application of technology which the Administrator determines will be available for the model year to which such standards apply”. Similarly, many commenters stated that EPA should finalize FEL caps that match the CARB Omnibus FEL caps (*i.e.*, 100 mg-hp-hr in 2024–2026 for all engine classes; 50 mg/hp-hr in 2027 and later for LHDEs and MHDE and 65 mg/hp-hr in 2027–2030 and 70 mg/hp-hr in 2031 and later for HHDEs). These commenters argue that aligning the FEL caps in the EPA final rule with those in the CARB Omnibus would reflect the technologies available in 2027 and later, and better align with the CAA 202(a)(3)(A) requirement for standards that reflect the greatest degree of emission reduction achievable. Commenters provide several lines of support that the CARB Omnibus FEL caps should provide the technical maximum for the EPA FEL caps. Namely, commenters stated that manufacturers will have been producing products to meet CARB Omnibus standard of 50 mg/hp-hr starting in 2024. They further state that two diesel engine families have been certified with CA for MY2022 at a FEL of 160 mg/hp-hr, which is only slightly higher than the FEL EPA proposed under option 1 for MY 2027 and would continue under the proposed FEL cap until MY2030. Finally, a commenter pointed to SwRI data showing that 50 mg/hp-hr can be achieved with what the commenter considers to be “minor changes to engine configuration.”

Commenters further argue that EPA should not base the FEL cap in the final rule on the average performance of recently certified engines since these engines were designed to comply with the current standards, which were set over 20 years ago, and do not utilize the emissions controls technologies that would be available in 2027. Commenters stated that EPA did not consider the extent to which the proposed FEL cap could adversely affect the emissions reductions expected from the rule. Commenters note that although EPA has previously set the FEL cap at the level of the previous standard, the current FEL cap was set lower than the previous standard due to the 90 percent reduction between the previous standard and the current standard. Commenters argue that EPA should similarly set the FEL cap below the current standard given the same magnitude in reduction between the current and proposed standards, and the greater level of certainty in the technologies available to meet the standards in this rule compared to previous rules.

Other commenters stated that a FEL cap of 100 mg/hp-hr, or between 50 and 100 mg/hp-hr, would help to prevent competitive disruptions. Additional details on comments received on the proposed FEL caps are available in section 12.2 of the Response to Comments document.

Our analysis and rationale for finalizing FEL caps of 65 mg/hp-hr in MY 2027 through 2030, and 50 mg/hp-hr in MY 2031 and later includes several factors. First, we agree with commenters that the difference between the current (0.2 g/hp-hr) standard and the standards we are finalizing for MY 2027 and later suggests that FEL caps lower than the current standard are appropriate to ensure that available emissions control technologies are adopted. This is consistent with our past practice when issuing rules for heavy-duty onroad engines or nonroad engines in which there was a substantial (*i.e.*, greater than 50 percent) difference between the numeric levels of the existing and new standards (69 FR 38997, June 29, 2004; 66 FR 5111, January 18, 2001). Specifically, by finalizing FEL caps below the current standards, we are ensuring that the vast majority of new engines introduced into commerce include updated emissions control technologies compared to the emissions control technologies manufacturers use to meet the current standards.<sup>408</sup>

Second, finalizing FEL caps below the current standard is consistent with comments from manufacturers stating that a FEL cap of 100 mg/hp-hr or between 50 and 100 mg/hp-hr would help to prevent competitive disruptions (*i.e.*, require all manufactures to make improvements in their emissions control technologies).

The specific numeric levels of the final FEL caps were also selected to balance several factors. These factors include providing sufficient assurance that low-emissions technologies will be introduced in a timely manner, which is consistent with our past practice (69 FR 38997, June 29, 2004), and providing manufacturers with flexibility in their product planning or assurance against unforeseen emissions-related problems that may arise. In the early years of the program (*i.e.*, MY2027 through 2030), we are finalizing a FEL cap of 65 mg/hp-hr to place more emphasis on providing manufacturers flexibility and assurance against unforeseen emissions control issues in order to ensure a smooth transition to the new standards and avoid market disruptions. A smooth transition in the early years of the program will help ensure the public health benefits of the final program by avoiding delayed emissions reductions due to slower fleet turnover than may occur without the flexibility of the final ABT. Thus, the final FEL cap in MY 2027 through 2030 can help to ensure the expected emissions reductions by providing manufacturers with flexibility to meet the final standards through the use of credits up to the FEL cap. In the later years of the program (*i.e.*, MY 2031 and later), we are finalizing a FEL cap of 50 mg/hp-hr to place more emphasis on ensuring continued improvements in the emissions control technologies installed on new engines.

We disagree with certain commenters stating that a certain numeric level of the FEL cap does or does not align with the CAA requirement to set “standards which reflect the greatest degree of emission reduction achievable through the application of technology which the Administrator determines will be available for the model year to which such standards apply”; rather, given the technology-forcing nature of the final standards, an optional compliance

production volume) of engines that meet the current standards for a few model years (*i.e.*, through MY 2029); thus, the vast majority of, but not all, new engines will need to include updated emissions control technologies compared to those used to meet today’s standards until MY 2031, when all engines will need updated emissions control technologies to comply with the final standards. See Section IV.G.9 for details on our approach and rationale for including this allowance in the final rule.

<sup>407</sup> EPA is reviewing a waiver request under CAA section 209(b) from California for the Omnibus rule.

<sup>408</sup> As discussed in Section IV.G.9, we are finalizing an allowance for manufacturers to continue to produce a small number (5 percent of

pathway, including the FEL caps and other elements of the ABT program, through the final rule is consistent with requirements under CAA section 202(a)(3)(A).<sup>409</sup> Nevertheless, as described in this Section IV.G.4, we are finalizing lower FEL caps than proposed as part of a carefully balanced final ABT program that provides flexibilities for manufacturers to generate NO<sub>x</sub> emissions credits while assuring that available emissions control technologies are adopted and the emissions reductions expected from the final program are realized.

Finally, we disagree with commenters stating a FEL cap can adversely affect the emissions reductions expected from the final rule. Inherent in the ABT program is the requirement for manufacturers producing engines above the emissions standard to also produce engines below the standard or to purchase credits from another manufacturer who has produced lower emitting engines. As such, while the FEL cap constrains the extent to which engines can emit above the level of the standard, it does not reduce the expected emissions reductions because higher emitting engines must be balanced by lower emitting engines. Without credit multipliers, an ABT program, and the associated FEL cap, may impact when emissions reductions occur due to manufacturers choosing to certify some engines to a more stringent standard and then later use credits generated from those engines, but it does not impact the absolute value of the emissions reductions. Rather, to the extent that credits are banked, there would be greater emissions reductions earlier in the program, which leads to greater public health benefits sooner than would otherwise occur; as discussed earlier in this Section IV.G, benefits realized in the near term are worth more to society than those deferred to a later time.

The FEL caps for the final rule have been set at a level to ensure sizeable emission reductions from the existing 2010 standards, while providing manufacturers with flexibility to meet the final standards. When combined with the other restrictions in the final ABT program (e.g., credit life, averaging sets, expiration of existing credit balances), we believe the final FEL caps of 65 mg/hp-hr in MY 2027 through 2030, and 50 mg/hp-hr in MY 2031 and later avoid potential adverse effects on

the emissions reductions expected from the final program.

#### 5. Credit Life for MY 2027 and Later Credits

As proposed, we are finalizing a five-year credit life for NO<sub>x</sub> emissions credits generated and used in MY 2027 and later, which is consistent with the existing credit life for CO<sub>2</sub>. In this section, IV.G.5, we briefly summarize our proposed credit life, stakeholder comments on the proposed credit life, and then discuss EPA's responses to comments along with our rationale for credit life in the final rule. Section IV.G.7 discusses credit life of credits generated in MYs 2022 through 2026 for use in 2027.

We proposed to update the existing credit life provisions in 40 CFR 1036.740(d) to apply for both CO<sub>2</sub> and NO<sub>x</sub> credits. The proposal updated the current unlimited credit life for NO<sub>x</sub> credits such that NO<sub>x</sub> emission credits generated for use in MY 2027 and later could be used for five model years after the year in which they are generated.<sup>410</sup> For example, under the proposal credits generated in model year 2027 could be used to demonstrate compliance with emission standards through model year 2032. We also requested comment on our proposed five-year credit life.

Several commenters provided perspectives on the proposal to revise the credit life of NO<sub>x</sub> emissions credits from unlimited to five years. Commenters took several different positions, including supporting the proposed five-year credit life, arguing that three years, not five, is the more appropriate credit life period, and arguing that credit life should be unlimited. Additional details and a summary of comments received on the proposed credit life are available in section 12 of the Response to Comments document.

The commenter supporting the proposed five-year credit life, rather than an unlimited credit life, states that they conducted an analysis that showed manufacturers had accrued credits from 2007–2009 MYs, which could have been used to certify engines up to the FEL cap in the Omnibus 2024–2026 program and would have delayed emissions reductions in those years. They further state that unlimited credit life would allow manufacturers to produce higher emitting engines against more stringent standards for many years (e.g., in MY2030).

The commenter arguing that three (not five) years is an appropriate credit life to average out year-to-year variability stated that three years aligns with the CAA requirement for three years of stability between changes in standards, and it represents the pace of improvement that manufacturers include in their product planning. The commenter argues that three years would be more protective under the CAA and is the duration that EPA previously used for NO<sub>x</sub> and PM emissions credits. Finally, the commenter states that EPA has not justified its choice of five years.

Commenters who urged EPA to finalize an unlimited credit life for NO<sub>x</sub> emissions credits did not provide data or rationale to support their assertion.

After further consideration, including consideration of public comments, EPA is finalizing as proposed a five-year credit life for credits generated and used in MY 2027 and later. The credit life in the final rule is based on consideration of several factors. First, consistent with our proposal, we continue to believe a limited credit life, rather than an unlimited credit life suggested by some commenters, is necessary to prevent large numbers of credits accumulating early in the program from interfering with the incentive to develop and transition to other more advanced emissions control technologies later in the program. Further, as discussed in Section IV.G.7, we believe the transitional credit program in the final rule addresses key aspects of manufacturers' requests for longer credit life. Second, as explained in the proposal, we believe a five-year credit life adequately covers a transition period for manufacturers in the early years of the program, while continuing to encourage technology development in later years.

We disagree with one commenter who stated that a three-year credit life is more appropriate than a five-year credit life. Rather, we believe five years appropriately balances providing flexibility in manufacturers product planning with ensuring available emissions control technologies are adopted. Further, as discussed in Section IV.G.4, inherent in an ABT program is the requirement for manufacturers producing engines above the emissions standard to also produce engines below the standard or to purchase credits from another manufacturer who has produced lower emitting engines. As such, while the five-year credit life in the final rule constrains the time period over which manufacturers can use credits, it does not impact the overall emissions

<sup>409</sup> See *NRDC v. Thomas*, 805 F. 2d 410, 425 (D.C. Cir. 1986) (upholding averaging as a reasonable and permissible means of implementing a statutory provision requiring technology-forcing standards).

<sup>410</sup> As discussed in Section IV.G.10, we are not finalizing the proposed allowance for manufacturers to generate credits from BEVs or FCEVs, and thus the credit life provisions in 40 CFR 1036.740(d) do not apply to BEVs or FCEVs.

reductions from the final rule. In addition, to the extent that credits are banked for five-years, the emissions reductions from those credits occur five-years earlier, and as discussed earlier in this Section IV.G, benefits realized in the near term are worth more to society than those deferred to a later time. Finally, a five-year credit life is consistent with our approach in the existing light-duty criteria and GHG programs, as well as our heavy-duty GHG program (see 40 CFR 86.1861–17, 86.1865–12, and 1037.740(c)).

As discussed in Section IV.G.7, we are finalizing a shorter credit life for credits generated in 2022 through 2026 with engines certified to a FEL below the current MY 2010 emissions standards, while complying with all other MY 2010 requirements, since these credits are generated from engines that do not meet the MY 2027 and later requirements. We are also finalizing longer credit life values for engines meeting all, or some of the key, MY 2027 and later requirements to further incentivize emissions reductions before the new standards begin (see IV.G.7 for details).

#### 6. Existing Credit Balances

After further consideration, including information received in public comments, the final rule will allow manufacturers to generate credits in MYs 2022 and later for use in MYs 2027 and later, as described further in the following Section IV.G.7. Consistent with the proposal, in the final program, manufacturers will not be allowed to use credits generated prior to model year 2022 when certifying to model year 2027 and later requirements.

We proposed that while emission credits generated prior to MY 2027 could continue to be used to meet the existing emission standards through MY 2026 under 40 CFR part 86, subpart A, those banked credits could not be used to meet the proposed MYs 2027 and later standards (except as specified in 1036.150(a)(3) for transitional and early credits in 1036.150(a)(1) and (2)). Our rationale included that the currently banked NO<sub>x</sub> emissions credits are not equivalent to credits that would be generated under the new program (e.g., credits were generated without demonstrating emissions control under all test conditions of the new program), and that EPA did not rely on the use of existing credit balances to demonstrate feasibility of the proposed standards.

Some commenters urged EPA to allow the use of existing credits, or credits generated after the release of the CTI ANPR, to be used in MYs 2027 and later. Commenters stated that EPA has

not demonstrated the standards are feasible without the use of credits, and that the credits were from engines with improved emissions that provide real-world NO<sub>x</sub> benefits, even if they are not certified to all of the test conditions of the proposed program. They further stated that not allowing the use of existing credits in 2027 and later could discourage manufacturers from proactively improving emissions performance. In contrast, other commenters support the proposal to discontinue the use of old credits (e.g., those generated before 2010) since allowing the use of these credits would delay emissions reductions and prevent a timely transition to new standards.

EPA did not rely on the use of existing or prior to MY 2027 credit balances to demonstrate feasibility of the proposed standards (see Section III) and continues to believe that credits from older model years should not be used to meet the final MY 2027 and later standards. Credits from older model years (i.e., MY 2009 or prior) were generated as manufacturers transitioned to the current standards, and thus would not require manufacturers to introduce new emissions control technologies to generate credits leading up to MY 2027. However, EPA agrees with some commenters that credits generated in model years leading up to MY 2027 are from engines with improved emissions controls and provide some real-world NO<sub>x</sub> benefits, even if they are not certified to all of the test conditions of the model year 2027 and later program. Therefore, the transitional credit program we are finalizing allows manufacturers to generate credits starting in model year 2022 for use in MYs 2027 and later; however, credits generated from engines in MYs 2022–2026 that do not meet all of the MY 2027 and later requirements are discounted to account for the differences in emissions controls between those engines and engines meeting all 2027 and later requirements (see Section IV.G.7 and Section 12 of the RTC for details). For credits generated in model years prior to MY 2022, we are finalizing that such emission credits could continue to be used to meet the existing emission standards through MY 2026 under 40 CFR part 86, subpart A.

We selected model year 2022 for two reasons. First, allowing MY 2022 and later credits inherently precludes emissions credits from the oldest model years (i.e., MY 2009 or prior). These oldest years are when the vast majority of existing credit balances were accumulated, to create flexibility in transitioning to the MY 2007–2010

standards.<sup>411</sup> The oldest model year credits were not generated with current emissions control technologies and are therefore quite distinct from credits generated under the final standards. Second, regarding both the oldest MY credits and those few generated in more recent years, allowing only MY 2022 and later credits incentivizes manufacturers to maximize their development and introduction of the best available emissions control technologies ahead of when they are required to do so in MY2027. As discussed in IV.G.7, this not only provides a stepping-stone to the broader introduction of this technology soon thereafter, but also encourages the early production of cleaner vehicles, which enhances the early benefits of our program. If we were to allow manufacturers to use emissions credits from older model years then there would be no incentive to apply new emissions control technologies in the years leading up to MY 2027. Further, we recognize that some manufacturers have begun to modernize some of their emissions controls in anticipation of needing to comply with the CARB Omnibus standards that begin in 2024,<sup>412</sup> or potential future Federal standards under this final rule, and agree with commenters that it's appropriate to recognize the effort to proactively improve emissions performance.<sup>413</sup> Thus, allowing credits generated in MY 2022 and later both recognizes improvements in emissions controls beyond what is needed to meet the current standards, and ensures that only credits generated in the model years leading up to 2027 can be used to meet the standards finalized in this rule.

#### 7. Transitional Credits Generated in MYs 2022 Through 2026

We are finalizing a transitional credit program that includes several pathways for manufacturers to generate transitional credits in MYs 2022 through 2026 that they can then use in MYs 2027 and later. The transitional credit pathways differ in several ways from

<sup>411</sup> EPA compliance data shows that prior to MY 2022, the majority of heavy-duty on-highway engine manufacturers were not generating NO<sub>x</sub> emissions credits in recent model years (i.e., since model year 2009).

<sup>412</sup> EPA is reviewing a waiver request under CAA section 209(b) from California for the Omnibus rule.

<sup>413</sup> As discussed in this Section IV.G, the final ABT program does not allow manufacturers to generate emissions credits from engines certified to state emission standards that are different than the federal standards; however, as discussed in IV.G.7, manufacturers could generate emissions credits if they produce larger volumes of engines to sell outside of those states that have adopted emission standards that are different than the federal standards.

what we proposed based on further consideration, including the consideration of public comments. In this section, IV.G.7, we briefly summarize our proposed transitional credit program, stakeholder comments on the proposed transitional credit program, and then discuss EPA's responses to comments along with our rationale for the transitional credit pathways in the final rule.

Under the proposed transitional credit program, manufacturers would generate transitional credits in model years 2024 through 2026. As proposed, manufacturers would have calculated transitional credits based on the current NO<sub>x</sub> emissions standards and useful life periods; however, manufacturers would have been required to certify to the other model year 2027 and later requirements, including the LLC and off-cycle test procedures. We proposed the same five-year credit life for transitional credits as other credits in the proposed general ABT program (see 87 FR 17553–17554 March 28, 2022, for additional details of the proposed transitional credits).

We requested comment on our proposed approach to offer transitional NO<sub>x</sub> emission credits that incentivize manufacturers to adopt the proposed test procedures earlier than required in MY 2027. We also requested comment on whether CI engines should be required to meet the proposed off-cycle standards to qualify for the transitional credits, and were specifically interested in comments on other approaches to calculating transitional credits before MY 2027 that would account for the differences in our current and proposed compliance programs. In addition, we requested comment on our proposed five-year credit life for transitional NO<sub>x</sub> emission credits. Finally, we also requested comment related to our proposed Early Adoption Incentives on whether EPA should adopt an incentive that reflects the MY 2024 Omnibus requirements being a step more stringent than our current standards, but less comprehensive than the proposed MY 2027 requirements.

Several commenters provided perspectives on the proposed transitional credit program under the ABT program. Most commenters either opposed allowing manufacturers to generate NO<sub>x</sub> emissions credits, or suggested additional requirements for generating credits that could be used in MYs 2027 and later. One commenter stated that due to lead time and resource constraints, manufacturers would not be able to participate in the proposed transitional credit program. Another commenter supported the proposed

transitional credit program. One commenter also stated that incentives for compliant vehicles, not just ZEVs, purchased prior to the MY 2027 will bring tremendous health benefits to at-risk communities and the nation. Similarly, one commenter encouraged EPA to further incentivize emissions reductions prior to the start of the new standards by providing additional flexibilities to use credits in MY 2027 and later if manufacturers were able to certify prior to MY 2027 a large volume of engines (*i.e.*, an entire engine service class) to almost all MY2027 and later requirements.

Commenters who opposed allowing manufacturers to generate NO<sub>x</sub> emissions credits prior to MY2027 were concerned that the difference between Federal and state (*i.e.*, CARB Omnibus) standards would result in “windfall of credits” that would allow a large fraction of engines to emit at the FEL cap into MY2030 and later. One commenter stated that EPA has not adequately assessed the potential erosion of emissions reductions from credits generated by engines certifying to the CARB Omnibus standards. Another commenter stated that manufacturers are already certifying to levels below the current MY2010 standards, and they believe that certifying to the new test procedures will take little effort for manufacturers. The commenter stated that there is no need to incentivize manufacturers to adopt proposed test procedures ahead of MY2027 because they will already be doing so under the Omnibus program. They argued that rather than requiring new testing, EPA should encourage new technology adoption. Commenters opposing the transitional credit program stated that EPA should eliminate the transitional credit program, or if EPA chooses to finalize the transitional credit program, then EPA should adjust the final standards to account for the transitional credit program impacts, or revise the transitional credit program (*e.g.*, shorten credit life to three years, establish a separate bank for credits generated by engines in states adopting the Omnibus standards). Two commenters stated that EPA should require engines generating credits prior to 2027 to meet all of the requirements of 2027 and beyond; they highlighted the importance of the 2027 and later low-load cycle and off-cycle standards to ensure real-world reductions on the road, and stated that there should be consistency in the way credits are generated and the way they are used. Similarly, these commenters oppose credits for legacy engines or legacy

technologies (*i.e.*, engines or technologies used to meet the current emissions standards).

The commenter who stated that manufacturers would be unable to generate credits under the proposed transitional credit due to lead time and resource constraints argued that manufacturers would be unable to adjust their engine development plans to meet the new LLC and off-cycle test standards in MY 2024. They further stated that in many cases deterioration factor (DF) testing has already started for MY 2024 engines. The commenter also argued that they view the ABT program as part of the emissions standards, and the proposed transitional credit program provided less than the four-year lead time that the CAA requires when setting heavy-duty criteria pollutant emissions standards. In addition, the commenter stated that the proposed transitional credit program would disincentivize manufacturers to make real-world NO<sub>x</sub> emissions reductions ahead of when new standards are in place because they would not be able to design and validate their engines to meet the requirements to generate credits.

Finally, a commenter suggested EPA further encourage additional emissions reductions prior to the start of new standards by providing greater flexibility to use credits in MYs 2027 and later.<sup>414</sup> Specifically, this commenter suggested that EPA provide a longer credit life (*e.g.*, ten years compared to the five years proposed for the ABT program) and also allow the movement of credits between averaging sets. The commenter stated that in order to generate credits with these additional flexibilities manufacturers would need to certify an entire engine service class (*e.g.*, all heavy heavy-duty engines a manufacturer produced) in a given model year to a FEL of 50 mg/hp-hr or less, and meet all other MY 2027 and later requirements. They further stated that it may not be appropriate for natural gas engines to generate credits with these additional flexibilities since natural gas engines can meet a 50 mg/hp-hr FEL today. Finally, the commenter stated that engines using these credits in MYs 2027 and later should be required to certify to a FEL of 50 mg/hp-hr or less. Additional details on comments regarding the proposed transitional credit program are included in section 12 of the Response to Comments document.

After considering comments on the proposed transitional credit program, we are choosing to finalize a revised

<sup>414</sup> U.S. EPA. Stakeholder Meeting Log. December 2022.

version of the proposed transitional credit program. Similar to the proposed rule, we are finalizing an optional transitional credit program to help us meet our emission reduction goals at a faster pace, while also providing flexibilities to manufacturers to meet new, more stringent emission standards. Building on the ABT program as whole, the transitional credit program in the final rule can benefit the environment and public health in two ways. First, early introduction of new emission control technologies can accelerate the entrance of lower-emitting engines and vehicles into the heavy-duty vehicle fleet, thereby reducing NO<sub>x</sub> emissions from the heavy-duty sector and lowering its contributions to ozone and PM formation before new standards are in place. Second, the earlier improvements in ambient air quality will result in public health benefits sooner than they would otherwise occur; these benefits are worth more to society than those deferred to a later time, and could be particularly impactful for communities already overburdened with pollution. As discussed in Section II, many state and local agencies have asked the EPA to further reduce NO<sub>x</sub> emissions, specifically from heavy-duty engines, because such reductions will be a critical part of many areas' strategies to attain and maintain the ozone and PM<sub>2.5</sub> NAAQS. Several of these areas are working to attain or maintain NAAQS in timeframes leading up to and immediately following the required compliance dates of the final standards, which underscores the importance of the early introduction of lower-emitting vehicles.

The transitional credit program is voluntary and as such no manufacturer is required to participate in the transitional credit program. The transitional credit program in the final rule will provide four pathways for manufacturers to generate credits in MYs 2022 through 2026 for use in MYs 2027 and later: (1) In MY 2026, certify all engines in the manufacturer's heavy heavy-duty service class to a FEL of 50 mg/hp-hr or less and meet all other EPA requirements for MYs 2027 and later to generate undiscounted credits that have additional flexibilities for use in MYs 2027 and later (2026 Service Class Pull Ahead Credits); (2) starting in MY 2024, certify one or more engine family(ies) to a FEL below the current MY2010 emissions standards and meet all other EPA requirements for MYs 2027 and later to generate undiscounted credits based on the longer UL periods included in the 2027 and later program (Full Credits); (3) starting in MY 2024,

certify one or more engine family(ies) to a FEL below the current MY2010 emissions standards and meet several of the key requirements for MYs 2027 and later, while meeting the current useful life and warranty requirements to generate undiscounted credits based on the shorter UL period (Partial Credits); (4) starting in MY 2022, certify one or more engine family(ies) to a FEL below the current MY2010 emissions standards, while complying with all other MY2010 requirements, to generate discounted credits (Discounted Credits).

All credits generated in the first pathway have an eight-year credit life and can therefore be used through MY 2034. All credits generated under the second or third pathways will expire by MY2033; all credits generated in the fourth pathway will expire by MY 2030. We further describe each pathway and our rationale for each pathway in this section (see the final interim provisions in 40 CFR 1036.150(a) for additional details).<sup>415</sup> In Section IV.G.8 we discuss our decision to finalize the transitional credit pathways in lieu of the proposed Early Adoption Incentives program (section 12 of the Response to Comments document includes additional details on the comments received on the proposed Early Adoption Incentives program).

In developing the final transitional credit program and each individual pathway, we considered several factors. For instance, for the transitional credit program as a whole, one commenter stated that there should be consistency in the way the credits are generated and the way they are used; several commenters urged EPA to only provide transitional credits to engines meeting all the 2027 and later requirements. The transitional credit program acknowledges these commenters' input by only providing full credit value to engines meeting all the 2027 and later requirements [*i.e.*, 2026 Service Class Pull Ahead Credits and Full Credits pathways], while providing a lesser value for credits generated from engines that do not meet all of the 2027 and later requirements but still demonstrate improved emissions performance compared to the current standards.

We now turn to discussing in detail each pathway, and the factors we considered in developing each pathway.

<sup>415</sup> We are finalizing as proposed a requirement that, to generate transitional NO<sub>x</sub> emission credits, manufacturers must meet the applicable PM, HC, and CO emission standards without generating or using emission credits. For the first and second pathways, applicable PM, HC, and CO emission standards are in 40 CFR 1036.104. For the third and fourth pathways (Partial and Discounted Credits), applicable PM, HC, and CO emission standards are in 40 CFR 86.007-11 or 86.008-10.

The first pathway acknowledges the significant emissions reductions that would occur if manufacturers were to certify an entire service class of heavy heavy-duty engines to a much lower numeric standard than the current standards and meet all other MY 2027 requirements prior to the start of the new standards. Specifically, compared to the emissions reductions expected from the final rule, our assessment shows significant, additional reductions in the early years of the program from certifying the entire heavy heavy-duty engine fleet to a FEL of 50 mg/hp-hr or less and meeting all other MY2027 requirements in MY 2026, one model year prior to the start of the new standards.<sup>416</sup> As discussed throughout this Section IV.G, emissions reductions, and the resulting public health benefits, that are realized earlier in time are worth more to society than those deferred to a later time. Based on the potential for additional, early emissions reductions, we are finalizing the 2026 Service Class Pull Ahead Credits pathway with two additional flexibilities for manufacturers to use the credits in MYs 2027 and later. First, 2026 Service Class Pull Ahead Credits have an eight-year credit life (*i.e.*, expire in MY 2034), which is longer than credits generated in the other transitional credit pathways, or under the main ABT program. Second, we are allowing 2026 Service Class Pull Ahead Credits to move from a heavy heavy-duty to a medium heavy-duty averaging set; however, credits moved between averaging sets will be discounted at 10 percent. We note that a recent assessment by an independent NGO shows that allowing credits to move between service classes could reduce the overall monetized health benefits of a program similar to the one in this final rule; however, the 10 percent discount rate that we are apply would more than offset the potential for reduced emissions reductions. Moreover, as noted in this section, the early emissions reductions from this transitional credit program would provide important positive benefits, particularly in communities

<sup>416</sup> See RIA Chapter 5.5.5 for additional details on our assessment of emissions reductions projected to occur from certifying engines to a FEL of 50 mg/hp-hr and meeting all other 2027 requirements in MY 2026. Note that for the purposes of bounding the potential emissions impacts, we assumed all heavy heavy-duty engines would participate in the 2026 Service Class Pull Ahead Credits pathway, and that those credits would be used by both medium and heavy heavy-duty engines in MY 2027 and later, until manufacturers used all of the credits.

overburdened with pollution.<sup>417</sup> Further, we are balancing these additional flexibilities with restrictions on which engines can participate in the 2026 Service Class Pull Ahead Credits pathway. Specifically, only heavy heavy-duty engines may generate 2026 Service Class Pull Ahead Credits; we expect a much lower level of investment would be required for natural gas-fueled engines, light heavy-duty engines, and SI engines to meet the 2026 Service Class Pull Ahead Credits requirements compared to the investment needed for heavy-heavy-duty engines. We expect that the combination of discounting credits moved across averaging sets and only allowing the heavy heavy-duty engine service class to participate in the 2026 Service Class Pull Ahead Credits pathway will appropriately balance the potential for meaningful emissions reductions in the early years of the program with the potential for adverse competitive disadvantages or environmental risks from either unequal investments to generate credits or producing large volumes of credits from engines that could easily meet the requirements of the 2026 Service Class Pull Ahead Credits pathway. Finally, engines certified using 2026 Service Class Pull Ahead Credits in 2027 through 2034 will need to meet a FEL of 50 mg/hp-hr or less; this requirement helps to ensure that these credits are used only to certify engines that are at least as low emitting as the engines that generated the credits.

The second pathway (Full Credits) acknowledges the emissions reductions that could be achieved prior to the start of new standards if manufacturers certify to a FEL lower than today's standard and meet all other MY 2027 and later requirements, although without doing so for an entire engine service class. This pathway is similar to our proposed transitional credit program and is consistent with input from commenters who highlighted the importance of meeting MY 2027 and later requirements such as the low-load cycle and off-cycle standards to ensure real-world reductions on the road. As proposed, all heavy-duty engine service classes, including heavy-duty natural gas engines in the respective service classes, can participate in this pathway.

The third pathway (Partial Credits) incentivizes manufacturers to produce engines that meet several of the key final requirements for MY 2027 and later, including the LLC and off-cycle standards for NO<sub>x</sub>, while meeting the

existing useful life and warranty periods.<sup>418</sup> This pathway allows manufacturers to adopt new emissions control technologies without demonstrating durability over the longer useful life periods required in MY 2027 and later, or certifying to the longer warranty periods in the final rule. We expect that some manufacturers may already be planning to produce such engines in order to comply with 2024 California Omnibus program; however, this transitional pathway would incentivize manufacturers to produce greater volumes of these engines than they would otherwise do to comply in states adopting the Omnibus standards. Some commenters were concerned that the proposed transitional credit program would result in "windfall credits" due to manufacturers generating credits from engines produced to comply with more stringent state standards. As discussed in IV.G, the final program will not allow manufacturers to generate credits from engines certified to meet state standards that are different from the Federal standards.<sup>419</sup> The Partial Credits pathway thus avoids "windfall credits" because manufacturers are not allowed to generate credits from engines produced to meet the more stringent 2024 Omnibus requirements, but rather are incentivized to produce cleaner engines that would benefit areas of the country where such engines may not otherwise be made available (*i.e.*, outside of states adopting the Omnibus

<sup>418</sup> Engines earning Partial Credits must comply with NO<sub>x</sub> standards over the Low Load Cycle and the off-cycle standards. The family emission limits for the Low Load Cycle and off-cycle standards are calculated relative to the family emission limit the manufacturer declares for FTP testing, as described in 40 CFR 1036.104(c). If we direct a manufacturer to do in-use testing for an engine family earning Partial Credits, we may direct the manufacturer to follow either the in-use testing program specified in 40 CFR part 1036 for NO<sub>x</sub>, or the in-use testing program in 40 CFR part 86 for all criteria pollutants. Except for the NO<sub>x</sub> standards for the Low Load Cycle and for off-cycle testing, engines generating Partial Credits would be subject to all the certification and testing requirements from 40 CFR part 86.

<sup>419</sup> See final part 1036, subpart H, and 40 CFR 1036.801 (which EPA did not propose any revisions to in the proposed migration from part 86, subpart A, to part 1036). See also the substantively similar definition of U.S.-directed production in current 40 CFR 86.004-2. Under 40 CFR 1036.705(c), which we are also finalizing as proposed as applicable for NO<sub>x</sub> ABT, compliance through ABT does not allow credit calculations to include engines excluded from the definition of U.S.-directed production volume: "As described in § 1036.730, compliance with the requirements of this subpart is determined at the end of the model year based on actual U.S.-directed production volumes. Keep appropriate records to document these production volumes. Do not include any of the following engines to calculate emission credits: . . . (4) Any other engines if we indicate elsewhere in this part 1036 that they are not to be included in the calculations of this subpart."

program).<sup>420</sup> Further, because engines participating in this pathway will be certified to shorter useful life periods, they will generate fewer credits than engines participating in the third and fourth pathways (Full Credits and 2026 Service Class Pull Ahead Credits).

The first, second, and third pathways all include meeting the LLC requirements for MY 2027 and later. One commenter suggested meeting the LLC would require manufacturers to simply meet a lower numeric standard than the current standard; however, EPA disagrees. Certifying to the LLC will require more than simply meeting a lower numeric standard since the LLC is a new test cycle that requires demonstration of emissions control in additional engine operations (*i.e.*, low load) compared to today's test cycles (see preamble Section III and section 3 of the Response to Comments document and for more discussion on the LLC).

Finally, the fourth pathway (Discounted Credits) allows manufacturers to generate credits for use in MY 2027 and later with engines that are not designed to meet the LLC and off-cycle standards and so could provide additional compliance flexibility for meeting the final standards; however, since the engines are not meeting the full requirements of the MY 2027 and later program the credits are discounted and will expire before credits generated in the other transitional credit pathways. This Discounted Credits pathway includes consideration of input from one commenter who stated that it would be infeasible for manufacturers to comply with the new LLC and off-cycle test procedures in MY 2024 in order to generate credits under the proposed credit program; they further argued that for manufacturers relying on credits to comply with the final standards, the proposed transitional credit program would not provide the lead time required by the CAA. As described in Section III of this preamble, the new standards in the final rule are feasible without the ABT program and without the use of transitional credits; participation in ABT is voluntary and is intended to provide additional flexibility to manufacturers through an optional compliance pathway. While manufacturers have the option of generating NO<sub>x</sub> emissions credits under the transitional credit program in the final rule, they are not required to do so. The four-year lead time requirement under CAA 202(a)(3) does not apply to these ABT provisions.

<sup>420</sup> EPA is reviewing a waiver request under CAA section 209(b) from California for the Omnibus rule.

<sup>417</sup> See U.S. EPA. Stakeholder Meeting Log. December 2022 for details of the assessment by the independent NGO (ICCT).

Nevertheless, the final rule allows credits generated under this Discounted Credits pathway to incentivize improvements in emissions controls, even if the engines are not certified to the full MY2027 and later requirements. Credits will be discounted by 40 percent to account for differences in NO<sub>x</sub> emissions during low-load and off-cycle operations between current engines and engines certifying to the model year 2027 and later requirements. While we expect that manufacturers certifying to a FEL below the current 200 mg/hp-hr standard will reflect improvement in emissions control over the FTP and SET duty-cycles, the discount applied to the credits accounts for the fact that these engines are not required to maintain the same level of emissions control over all operations of the off-cycle standards, or during the low-load operations of the LLC. For example, a manufacturer certifying a HHDE engine family to a FEL of 150 mg/hp-hr and all other MY 2010 requirements with a U.S.-directed production volume of 50,000 engines in 2024 would generate approximately 5,000 credits (see Equation IV-1), which they would then multiply by 0.6 to result in a final credit value of 3,000 credits. See the final, revised from proposal, interim provision in 40 CFR 1036.150(a)(1) for additional details on the calculation of discounted credits.

Credits generated under this Discounted Credits pathway could be used in MY 2027 through MY 2029. The combination of the discount and limited number of model years in which manufacturers are allowed to use these credits is consistent with our past practice and helps to address some commenters' concerns about allowing legacy engines to generate credits, or credits generated under the transitional credit program eroding emissions reductions expected from the rule (55 FR 30584–30585, July 26, 1990). There are two primary ways that the Discounted Credits pathway results in positive public health impacts. First, an immediate added benefit to the environment is the discounting of credits, which ensures that there will be a reduction of the overall emission level. The 40 percent discount provides a significant public health benefit, while not being so substantial that it would discourage the voluntary initiatives and innovation the transitional ABT program is designed to elicit. Second, consistent with the benefits of the overall transitional credit program, when the “time value” of benefits (*i.e.*, their present value) is taken into account, benefits realized in the near term are worth more to society than

those deferred to a later time. The earlier expiration date of credits in the Discounted Pathway reflects that these credits are intended to help manufacturers transition in the early years of the program, but we don't think they are appropriate for use in later years of the program. The earlier expiration of credits is also consistent with comments that we should finalize a 3-year credit life for transitional credits (*i.e.*, credits can be used for 3-years once the new standards begin).

As discussed earlier in this Section IV.G.7, credits generated under the first pathway (2026 Service Class Pull Ahead Credits) can be used for eight years, through MY 2034; we selected this expiration date to balance incentivizing manufacturers to participate in the 2026 Credits pathway and thereby realize the potential for additional, early emissions reductions, with continuing to encourage the introduction of improved emissions controls, particularly as the heavy-duty fleet continues to transition into zero emissions technologies.<sup>421</sup> As stated in the preceding paragraphs, all credits generated in the second and third pathways can be used through MY 2032. Our rationale for this expiration date is two-fold. First, providing a six-year credit life from when the new standards begin provides a longer credit life than provided in the final ABT program for credits generated in MY 2027 and later; similar to the first pathway, this longer credit life incentivizes manufacturers to produce engines that emit lower levels of NO<sub>x</sub> earlier than required. Second, the six-year credit life balances additional flexibility for manufacturers to transition over all of their product lines with the environmental and human health benefits of early emissions reductions. This transitional period acknowledges that resource constraints may make it challenging to convert over all product lines immediately when new standards begin, but maintains emission reductions projected from program by requiring the use of credits to certify engines that emit above the level of the new standard. While some commenters stated that manufacturers will have been complying with the CARB Omnibus program starting in 2024, we acknowledge that complying with the 2027 and later Federal standards will require another step in technology and thus think it is appropriate to provide additional flexibility for manufacturers

<sup>421</sup> As discussed in RIA 5.5.5, our evaluation shows that manufacturers would use all 2026 Service Class Pull Ahead Credits in about an eight-year period, which further supports the eight-year credit life of the 2026 Service Class Pull Ahead Credits pathway.

to transition to the new standards through the use of emissions credits in the ABT program.

This section describes how to generate credits for MY 2026 and earlier engines that are certified to standards under 40 CFR part 86, subpart A. As noted in Section III.A.3, we are allowing manufacturers to continue to certify engines to the existing standards for the first part of model year 2027. While those engines continue to be subject to standards under 40 CFR part 86, subpart A, we are not allowing those engines to generate credits that carry forward for certifying engines under 40 CFR part 1036.<sup>422</sup> Manufacturers may only generate NO<sub>x</sub> emissions credits under transitional credit pathways for MY 2024–2026 engines since one purpose of transitional credits is to incentivize emission reductions in the model years leading up to MY 2027. To the extent manufacturers choose to split MY 2027, the engines produced in the first part of the split MY are produced very close in time to when the new standards will apply, and thus we expect that rather than incentivizing earlier emission reductions, providing an allowance to generate NO<sub>x</sub> emission credits would incentivize production at higher volumes during the first part of the split MY than would otherwise occur (*i.e.*, incentivizing more of the MY 2027 production before the final standards apply). The higher production volume of engines in the first part of the split MY could thereby result in additional NO<sub>x</sub> emission credits without additional emission reductions that would otherwise occur. See preamble Section III.A.3 for details on the split model year provision in this final rule.

## 8. Early Adoption Incentives

EPA is choosing not to finalize the Early Adoption Incentives program as proposed. This includes a decision not to include emissions credit multipliers in the final ABT program. Rather, we are finalizing a revised version of the transitional credit program under the ABT program as described above in Section IV.G.7. In this Section IV.G.8 we briefly describe the proposed Early Adoption Incentives program, stakeholder comments on the proposed Early Adoption Incentives program, and then discuss EPA's responses to comments along with our rationale for

<sup>422</sup> MY 2027 engines produced prior to four years after the date that the final rule is promulgated and certified to the existing 40 CFR part 86 standards cannot participate in the part 1036 ABT program; however, MY 2027 engines certified to 40 CFR part 1036 standards and requirements may participate in the ABT program specified in 40 CFR part 1036, subpart H.



choosing not to finalize the Early Adoption Incentives program.

We proposed an early adoption incentive program that would allow manufacturers who demonstrated early compliance with all of the final MY 2027 standards (or MY 2031 standards under proposed Option 1) to include Early Adoption Multiplier values of 1.5 or 2.0 when calculating NO<sub>x</sub> emissions credits. In the proposed Early Adoption Incentives program, manufacturers could generate credits in MYs 2024 through 2026 and use those credits in MYs 2027 and later.

We requested comment on all aspects of our proposed early adoption incentive program. We were aware that some aspects of the proposed requirements could be challenging to meet ahead of the required compliance dates, and thus requested comment on any needed flexibilities that we should include in the early adoption incentive program in the final rule. See 87 FR 17555, March 28, 2022, for additional discussion on the proposed Early Adoption Incentives program, including specifics of our requests for comment.

Several commenters provided general comments on the proposed Early Adoption Incentive program. Although many of the commenters generally supported incentives such as emissions credit multipliers to encourage early investments in emissions reductions technology, several were concerned that the emissions credit multipliers would result in an excess of credits that would undermine some of the benefits of the rule; other commenters were concerned that the multipliers would incentivize some technologies (e.g., hybrid powertrains, natural gas engines) over others (e.g., battery-electric vehicles).

As described in preamble Section IV.G.7, the revised transitional credit program that we are finalizing provides discounted credits for engines that do not comply with all of the MY 2027 and later requirements. In addition, after consideration of comments responding to our request for comment about incentivizing early reductions through our proposed transitional and Early Adoption Incentive program, the final transitional credit program includes an additional pathway that incentivizes manufacturers to produce engines that meet several of the key final requirements for MY 2027 and later, including the LLC and off-cycle standards for NO<sub>x</sub>, while meeting the current useful life and warranty periods. We expect that this transitional credit pathway will incentivize manufacturers to produce greater volumes of the same or similar engines that they plan to produce to comply with the MY 2024

Omnibus requirements. By choosing not to finalize the Early Adoption Incentives program and instead finalizing a modified version of the Transitional Credit program, we are avoiding the potential concern some commenters raised that the credit multipliers would result in a higher volume or magnitude of higher-emitting MY 2027 and later engines compared to a program without emission credit multipliers. We believe the Transitional Credit program we are finalizing will better balance incentivizing emissions reduction technologies prior to MY 2027 against avoiding an excess of emissions credits that leads to much greater volumes or magnitudes of higher-emitting engines in MYs 2027 and later. Moreover, by not finalizing the Early Adoption Incentive program we are avoiding any concerns that the emissions credit multipliers would incentivize some technologies over others (see section 12.5 of the Response to Comments and preamble Section IV.G.10 for additional discussion on battery-electric and fuel cell electric vehicles in the final rule; see section 3 of the Response to Comments for discussion on additional technology pathways).

#### 9. Production Volume Allowance

After further consideration, including consideration of public comments, EPA is finalizing an interim production volume allowance for MYs 2027 through 2029 in 40 CFR 1036.150(k) that is consistent with our request for comment in the proposal, but different in several key aspects. In particular, the production volume allowance we are finalizing allows manufacturers to use NO<sub>x</sub> emissions credits to certify a limited volume of heavy heavy-duty engines compliant with pre-MY 2027 requirements in MYs 2027 through 2029.<sup>423</sup> In addition, since we are requiring the use of credits to certify MY 2010 compliant heavy heavy-duty engines in the early years of the final program, and to aid in implementation, we are choosing to not limit the applications that are eligible for this production volume allowance. Finally, the production volume allowance in the final rule will be five percent of the average U.S.-directed production volumes of Heavy HDE over three model years, see 40 CFR 1036.801, and thus excludes engines certified to different emission standards in CA or other states adopting the Omnibus program. In this section, IV.G.9, we summarize our

request for comment on a production volume allowance, related stakeholder comments, and EPA's responses to comments along with our rationale for the production volume allowance in the final rule.

In the proposal we stated that we were considering a flexibility to allow engine manufacturers, for model years 2027 through 2029 only, to certify up to five percent of their total production volume of heavy-duty highway CI engines in a given model year to the current, pre-MY 2027 engine provisions of 40 CFR part 86, subpart A. We stated the allowance would be limited to Medium HDE or Heavy HDE engine families that manufacturers show would be used in low volume, specialty vocational vehicles. We noted that such an allowance from the MY 2027 criteria pollutant standards may be necessary to provide engine and vehicle manufacturers additional lead time and flexibility to redesign some low sales volume products to accommodate the technologies needed to meet the proposed more stringent engine emission standards.

We requested comment on the potential option of a three-year allowance from the proposed MY 2027 criteria pollutant standards for engines installed in specialty vocational vehicles, including whether and why the flexibility would be warranted and whether 5 percent of a manufacturer's engine production volume is an appropriate value for such an interim provision. In addition, we requested comment on whether the flexibility should be limited to specific vocational vehicle regulatory subcategories and the engines used in them.

Several commenters provided perspectives on our request for comment on providing an additional flexibility that would allow manufacturers to certify up to five percent of their total production volume of 2027 through 2029 MY medium and heavy HDEs to the current Federal engine provisions. Many environmental and state organizations opposed the potential production volume allowance, while most manufacturers and one supplier generally supported the potential allowance although they suggested changes to the parameters included in the proposal.

Commenters opposing the production volume allowance had two primary concerns. First, they stated that the production volume flexibility is not needed because there is enough lead time between now and MY 2027 to develop the technologies and overcome any packaging challenges. One commenter further noted that the CARB

<sup>423</sup> Engines certified under this production volume allowance would meet the current, pre-MY 2027 engine provisions of 40 CFR part 86, subpart A.

Omnibus standards would already be in effect in 15 percent of the market. Second, commenters argued that the production volume allowance would result in high NO<sub>x</sub> emissions and adverse health effects, particularly in high-risk areas, which would undermine the effectiveness of the rule to reduce emissions and protect public health. One commenter noted that HHDEs last for many years before being scrapped and that the production volume allowance, combined with other flexibilities in the proposal, could result in significant emissions impacts for many years to follow, which would create extreme difficulty for California and other impacted states to achieve air quality goals. Another commenter estimated that in MY 2027 through 2029, the production volume allowance would result in 20,000 vehicles emitting nearly 6 times more NO<sub>x</sub> on the FTP cycle than proposed Option 1, and that these vehicles could represent 20–25 percent of the total NO<sub>x</sub> emissions from MY 2027 through 2029 vehicles. Still another commenter stated that the production volume allowance would result in up to a 45 percent increase in NO<sub>x</sub> emissions inventory for each applicable model year's production from a manufacturer with products in a single useful life and power rating category; the commenter noted that the emissions inventory impact could be even greater if a manufacturer used the five percent allowance for engines with longer useful life periods and higher power ratings. One commenter opposing the production volume allowance stated that EPA should not exempt any engines from complying with the adopted new emission standards for any amount of time. Other commenters opposing the production volume allowance stated that if EPA chose to finalize a production allowance then emissions from those engines should be offset with ABT emission credits to protect vulnerable impacted communities. Finally, one commenter opposing the production volume allowance state that if EPA chose to finalize the production allowance then the Agency should provide strong technical justification for each engine category subject to the provision.

Commenters generally supporting the production volume allowance suggested several ways to further limit the flexibility, or suggested additional flexibilities based on the CARB Omnibus program. For instance, several engine manufacturers and their trade association suggested limiting the provision to include only engines with low annual miles traveled to minimize

the emissions inventory impacts. These commenters suggested limiting the allowance to engines with greater than or equal to 525 hp or 510 hp in specific vehicle applications, namely: Heavy-haul tractors and custom chassis motor homes, concrete mixers, and emergency vehicles. Two engine manufacturers further suggested the production volume allowance include vehicles where aftertreatment is mounted off the frame rails, or that EPA review and approve applications demonstrating severe packaging constraints for low volume, highly specialized vocational applications. Another engine manufacturer argued that manufacturers need to be able to carry over some existing engines into MY 2027 and later for a few years in order to adequately manage investments and prioritize ultra-low NO<sub>x</sub> and ZEV technology adoption in the applications that make the most sense. They further stated that EPA should consider alternate credit program options that can be used to truly manage investment and to prioritize appropriate applications by allowing manufacturers to leverage credits to stage development programs. One engine manufacturer and one supplier suggested EPA consider programs similar to the CARB Omnibus' separate certification paths for 'legacy engines,' emergency vehicles, and low-volume high horsepower engines. Additional details on comments received on the request for comment on a potential production volume allowance are available in section 12.7 of the Response to Comments.

After considering comments on the proposed production volume allowance, we are finalizing an allowance in MY 2027 through 2029 for manufacturers to certify up to five percent of their Heavy HDE U.S.-directed production volume averaged over three model years (MY 2023 through 2025) as compliant with the standards and other requirements of MY 2026 (*i.e.*, the current, pre-MY 2027 engine provisions of 40 CFR part 86, subpart A). As explained earlier in this Section IV.G, U.S.-directed production volume excludes engines certified to different state emission standards (*e.g.*, would exclude engines certified to CARB Omnibus standards if EPA grants the pending waiver request), and thus would be a smaller total volume than all Heavy HDE engine production in a given model year.<sup>424 425</sup> By finalizing a production volume allowance based on the average U.S.-directed production

<sup>424</sup> See final part 1036, subpart H, and 40 CFR 1036.801.

<sup>425</sup> EPA is reviewing a waiver request under CAA section 209(b) from California for the Omnibus rule.

volume over three model years (MY 2023 through 2025), rather than an allowance that varies by production volume in each of the model years included in the allowance period (MY 2027 through 2029), we are providing greater certainty to manufacturers and other stakeholders regarding the number of engines that could be produced under this allowance. Further, we avoid the potential for economic conditions in any one year to unduly influence the volume of engines that could be certified under this allowance. Based on EPA certification data, we estimate that five percent MY 2021 Heavy HDE would result in approximately 12,000 engines per year permitted under this allowance.<sup>426</sup>

We are limiting the final production volume allowance to Heavy HDE, rather than Heavy HDE and Medium HDE as proposed, because comments from manufacturers generally pointed to Heavy HDE applications or otherwise suggested limiting the allowance to larger engines (*e.g.*, greater than 510 hp). After considering comments on the vehicle categories to include in the production volume allowance, we are choosing not to specify the vehicle categories for engines certified under this production volume. Our rationale includes three main factors. First, we are requiring manufacturers to use credits to certify engines under the production volume allowance, which will inherently result in the production of lower-emitting engines to generate the necessary credits. We believe requiring emission credits to certify engines under the production volume allowance better protects the expected emission reductions from the final rule than limiting the production allowance to specific vehicle categories. Our approach is consistent with some commenters' recommendation to finalize a program that required the use of emission credits to protect vulnerable impacted communities by ensuring that lower-emitting engines are produced earlier to generate the credits necessary to produce engines certified under this allowance. Second, a variety of vehicle categories were identified in comments as vehicle categories for which manufacturers may need additional lead time and flexibility to redesign to accommodate the technologies needed to meet the final emission standards. We expect that the specific vehicle

<sup>426</sup> We note that there would be fewer engines eligible for this allowance in the event we approve the pending waiver request since our existing regulations provide that the production volume allowance would exclude engines certified to state emission standards that are different than the federal standards.

category(ies) for which additional lead time and flexibility is of interest will vary by manufacturer, and thus are choosing not to specify vehicle categories to avoid competitive disruptions. Finally, we are choosing not to limit the production volume allowance to specific vehicle categories to simplify and streamline implementation; the specific vehicle in which an engine will be installed is not always known when an engine is produced, which would make implementing restrictions on engines installed in specific vehicle categories challenging for both EPA and manufacturers.

We continue to believe it is important to ensure that technology turns over in a timely manner and that manufacturers do not continue producing large numbers of higher-emitting pre-MY 2027 compliant engines once the MY 2027 standards are in place. The combination of a limited production volume (*i.e.*, five percent of the average U.S.-directed production volume over three model years, (MY 2023 through 2025, in MYs 2027 through 2029) and a requirement to use credits will prevent the production of large numbers of these higher emitting engines, while providing additional flexibility for manufacturers to redesign engine product lines to accommodate the technologies needed to meet the final emission standards.

For engines certified under the production volume allowance, manufacturers would need to meet the standards and related requirements that apply for model year 2026 engines under 40 CFR part 86, subpart A. Engine families must be certified as separate engine families that qualify for carryover certification, which means that the engine family would still be properly represented by test data submitted in an earlier model year.

Manufacturers would need to declare a NO<sub>x</sub> family emission limit (FEL) that is at or below the standard specified in 40 CFR 86.007–11 and calculate negative credits by comparing the declared NO<sub>x</sub> FEL to the FTP emission standard for model year 2027 engines. In addition, manufacturers would calculate negative credits using a value for useful life of 650,000 miles to align with the credit calculation for engines that will be generating credits under 40 CFR part 1036 starting in model year 2027 (see Equation IV–I for credit calculation). The inclusion of useful life and work produced over the FTP in the calculation of credits addresses some commenters' concern regarding the production of engines with higher power ratings and longer useful life

periods under the production volume allowance. Manufacturers would need to demonstrate compliance with credit accounting based on the same ABT reporting requirements that apply for certified engines under 40 CFR part 1036.

See 40 CFR 1036.150(k) for additional details on the limited production volume allowance in the final rule.

#### 10. Zero Emission Vehicle NO<sub>x</sub> Emission Credits

After further consideration, including consideration of public comments, EPA is not finalizing the proposed allowance for manufacturers to generate NO<sub>x</sub> emissions credits from heavy-duty zero emissions vehicles (ZEVs). Rather, the current 40 CFR 86.016–1(d)(4), which specifies that heavy-duty ZEVs may not generate NO<sub>x</sub> or PM emission credits, will continue to apply through MY 2026, after which 40 CFR 1037.1 will apply. The final 40 CFR 1037.1 migrates without revisions the text of 40 CFR 86.016–1(d)(4), rather than the revisions we proposed to allow manufacturers to generate NO<sub>x</sub> emissions credits from ZEVs.<sup>427 428</sup> In this Section IV.G.10, we briefly describe the proposal to allow manufacturers to generate NO<sub>x</sub> emissions credits from ZEVs; the comments received on the proposal to allow ZEV NO<sub>x</sub> credits; and EPA's response to those comments, which includes our rationale for the approach to ZEV NO<sub>x</sub> credits in the final rule.

We proposed that if manufacturers met certain requirements, then they could generate NO<sub>x</sub> emissions credits from battery-electric vehicles, BEVs, and fuel cell electric vehicles, FCEVs; we refer to BEVs and FCEVs collectively as zero emissions vehicles, ZEVs.<sup>429</sup> Under

<sup>427</sup> At the time of proposal, we referred to battery-electric vehicles (BEVs) and fuel cell electric vehicles (FCEVs); in this final rule we generally use the term zero emissions vehicles (ZEVs) to collectively refer to both BEVs and FCEVs.

<sup>428</sup> As proposed, we are consolidating certification requirements for BEVs and FCEVs over 14,000 pounds GVWR in 40 CFR part 1037 such that manufacturers of BEVs and FCEVs over 14,000 pounds GVWR would certify to meeting the emission standards and requirements of part 1037, as provided in the current 40 CFR 1037.1. The final 1037.1 migrates without revisions the text of 40 CFR 86.016–1(d)(4), rather than the revisions we proposed to allow manufacturers to generate NO<sub>x</sub> emissions credits from BEVs and FCEVs. See preamble Section III for additional details on the migration of 40 CFR 86.016–1(d)(4) to 40 CFR 1037.1.

<sup>429</sup> We also proposed to allow manufacturers to optionally test the hybrid engine and powertrain together, rather than testing the engine alone, to demonstrate the NO<sub>x</sub> emission performance of hybrid electric vehicle (HEV) technologies; if the emissions results of testing the hybrid engine and powertrain together showed NO<sub>x</sub> emissions lower than the final standards, then manufacturers could choose to participate in the NO<sub>x</sub> ABT program; see

the proposal, manufacturers would calculate the value of NO<sub>x</sub> emission credits generated from ZEVs using the same equation provided for engine emission credits (see Equation IV–1 in final preamble Section IV.G.2). To generate the inputs to the equation, we proposed that manufacturers would submit test data at the time of certification, which is consistent with requirements for CI and SI engine manufacturers to generate NO<sub>x</sub> emissions credits. We proposed that vehicle manufacturers, rather than powertrain manufacturers, would generate vehicle credits for ZEVs since vehicle manufacturers already certify ZEVs to GHG standards under 40 CFR part 1037. To ensure that ZEV NO<sub>x</sub> credits were calculated accurately, and reflected the environmental and public health benefits of vehicles with zero tailpipe emissions over their full useful life, we proposed that in MY 2024 and beyond, ZEVs used to generate NO<sub>x</sub> emission credits would need to meet certain battery and fuel cell performance requirements over the useful life period (*i.e.*, durability requirements).

We requested comment on the general proposed approach of allowing ZEVs to generate NO<sub>x</sub> credits, which could then be used in the heavy-duty engine ABT program. We also requested comment on several specific aspects of our proposal. See 87 FR 17558, March 28, 2022, for additional discussion on the proposal to allow manufacturers to generate NO<sub>x</sub> emissions credits from ZEVs if those vehicles met the specified requirements.

Numerous commenters provided feedback on EPA's proposal to allow manufacturers to generate NO<sub>x</sub> emissions credits from ZEVs. The majority of commenters oppose allowing manufacturers to generate NO<sub>x</sub> emissions credits from ZEVs. Several additional commenters oppose ZEV NO<sub>x</sub> emissions credits unless there were restrictions on the credits (*e.g.*, shorter credit life, sunseting credit generation in 2026). Other commenters support allowing manufacturers to generate NO<sub>x</sub> emissions credits from electric vehicles. Arguments from each of these commenter groups are summarized immediately below.

Commenters opposing NO<sub>x</sub> emissions credits for ZEVs present several lines of argument, including the potential for: (1) Substantial impacts on the emissions reductions expected from the proposed rule, which could also result in disproportionate impacts in disadvantaged communities already

preamble Section III.A for details on HEVs in the final rule.

overburdened with pollution; (2) a lack of improvements in conventional engine technologies; and (3) ZEV NO<sub>x</sub> credits to result higher emissions from internal combustion engines, rather than further incentivizing additional ZEVs (further noting that other State and Federal actions are providing more meaningful and less environmentally costly HD ZEV incentives). Stakeholders opposing NO<sub>x</sub> emissions credits from ZEVs were generally environmental or state organizations, or suppliers of heavy-duty engine and vehicle components.

In contrast, several commenters support allowing manufacturers to generate these credits. Many of these commenters are heavy-duty engine and vehicle manufacturers. Commenters supporting an allowance to generate NO<sub>x</sub> emissions credits from ZEVs also provided several lines of argument, including the potential for: (1) ZEVs to help meet emissions reductions and air quality goals; (2) ZEV NO<sub>x</sub> credits to be essential to the achievability of the standards for some manufacturers; and (3) ZEV NO<sub>x</sub> credits to allow manufacturers to manage investments across different products and ultimately result in increased ZEV deployment. Each of these topic areas is discussed further in section 12.5 of the Response to Comments document.

Three considerations resulted in our decision not to finalize at this time the allowance for manufacturers to generate NO<sub>x</sub> emissions credits from heavy-duty ZEVs. First, the standards in the final rule are technology-forcing, yet achievable for MY2027 and later internal combustion engines without this flexibility. Second, since the final standards are not based on projected utilization of ZEV technology, and given that we believe there will be increased penetration of ZEVs in the HD fleet by MY2027 and later, we are concerned that allowing NO<sub>x</sub> emissions credits would result in fewer emissions reductions than intended from this rule.<sup>430</sup> For example, by allowing manufacturers to generate ZEV NO<sub>x</sub> credits, EPA would be allowing higher emissions (through engines using credits to emit up to the FEL cap) in MY 2027 and later, without requiring commensurate emissions reductions (through additional ZEVs beyond those already entering the market without this rule), which could be particularly

<sup>430</sup> For example, the recently passed Inflation Reduction Act (IRA) has many incentives for promoting zero-emission vehicles, see Sections 13403 (Qualified Clean Vehicles), 13404 (Alternative Fuel Refueling Property Credit), 60101 (Clean Heavy-Duty Vehicles), 60102 (Grants to Reduce Air Pollution at Ports), and 70002 (United States Postal Service Clean Fleets) of H.R. 5376.

impactful in communities already overburdened by pollution. Third, we continue to believe that testing requirements to ensure continued battery and fuel cell performance over the useful life of a ZEV may be important to ensure the zero-emissions tailpipe performance for which they are generating NO<sub>x</sub> credits; however, after further consideration, including consideration of public comments, we believe it is appropriate to take additional time to work with industry and other stakeholders on any test procedures and other specifications for ZEV battery and fuel cell performance over the useful life period of the ZEV (see section 12.6 of the Response to Comments document for additional detail on comments and EPA responses to comments on the proposed ZEV testing and useful life and warranty requirements).

In section 12.6 of the Response to Comments document, we further discuss each of these considerations in our decision not to finalize the allowance for manufacturers to generate NO<sub>x</sub> emissions credits from ZEVs. Additional detail on comments received and EPA responses to comments, including comments on more specific aspects of comments on the proposed allowance for ZEV NO<sub>x</sub> emissions credits, such as testing, useful life, and warranty requirements for ZEVs, are also available in section 12.6 of the Response to Comments document. Our responses to comments on the proposed vehicle certification for ZEVs are summarized in preamble Section III, with additional detail in section 12.6.3 of the Response to Comments document.

## V. Program Costs

In Chapter 3 of the RIA, we differentiate between direct, indirect, and operating costs when estimating the costs of the rule. “Direct” costs represent the direct manufacturing costs of the technologies we expect to be used to comply with the final standards over the final useful lives; these costs accrue to the manufacturer. In this section we use those costs to estimate the year-over-year manufacturing costs going forward from the first year of implementation. “Indirect” costs, *i.e.*, research and development (R&D), administrative costs, marketing, and other costs of running a company, are associated with the application of the expected technologies and also accrue to the manufacturer. Like direct costs, indirect costs are expected to increase under the final standards, in part due to the useful life provisions. Indirect costs are also expected to increase under the

final program due to the warranty provisions. We term the sum of these direct and indirect costs “technology costs” or “technology package costs.” They represent the costs incurred by manufacturers—*i.e.*, regulated entities—to comply with the final program.<sup>431</sup> “Operating” costs represent the costs of using the technology in the field. Operating costs include, for example, changes in diesel exhaust fluid (DEF) consumption or fuel consumption. These costs accrue to the owner/operator of MY 2027 and later heavy-duty vehicles.<sup>432</sup> We present total costs associated with the final program in Section V.C. All costs are presented in 2017 dollars consistent with the proposed cost analysis, unless noted otherwise.

We requested comment on all aspects of the cost analysis. In particular, we requested comment on our estimation of warranty and research and development costs via use of scalars applied to indirect cost contributors (see Section V.A.2) and our estimates of emission repair cost impacts (see Section V.B.3). We also requested that comments include supporting data and/or alternative approaches that we could have considered when developing estimates for the final rulemaking.

In response to our requests, we received many helpful comments, although lack of data in conjunction with some comments made it challenging to evaluate the changes suggested by the commenter. After careful consideration of the comments we received, we have made several changes to the final cost analysis relative to the proposal. Those changes are summarized in Table V–1. Note that, throughout this discussion of costs, we use the term regulatory class which defines vehicles with similar emission standards (see Chapter 5.2.2 of the RIA); we use the term regulatory class for consistency with our MOVES model and its classification system so that our costs align with our inventory estimates

<sup>431</sup> More precisely, these technology costs represent costs that manufacturers are expected to attempt to recapture via new vehicle sales. As such, profits are included in the indirect cost calculation. Clearly, profits are not a “cost” of compliance—EPA is not imposing new regulations to force manufacturers to make a profit. However, profits are necessary for manufacturers in the heavy-duty industry, a competitive for-profit industry, to sustain their operations. As such, manufacturers are expected to make a profit on the compliant vehicles they sell, and we include those profits in estimating technology costs.

<sup>432</sup> Importantly, the final standards, useful lives, and warranty periods apply only to new, MY 2027 and later heavy-duty vehicles. The legacy fleet is not subject to the new requirements and, therefore, users of prior model year vehicles will not incur the operating costs we estimate.

and the associated benefits discussed in Sections VI, VII and VIII.

TABLE V-1—MAJOR CHANGES TO THE COST ANALYSIS SINCE PROPOSAL

Area of change	Proposed analysis	Final analysis
Warranty costs .....	Warranty contributions to indirect costs were scaled using the ratio of proposed provisions (miles/age) to the baseline provisions.	Warranty costs are calculated using a starting point of \$1,000 (2018 dollars, \$976 in 2017 dollars) per year of warranty coverage for a vehicle equipped with a heavy HDE; warranty costs for other regulatory classes were scaled by the ratio of the direct manufacturing costs (DMC) for the regulatory class to the DMC of the heavy HDE regulatory class.
Warranty costs .....	Baseline warranty costs were estimated for the regulated warranty period only (i.e., the analysis assumed that no vehicles were purchased with extended warranties).	Baseline warranty costs are estimated assuming that a percentage of vehicles are purchased with extended warranties.
Emission repair costs ....	Repair costs used a cost per mile curve derived from a Fleet Advantage Whitepaper with direct manufacturing cost (DMC) ratio scalars applied to determine cost per mile values for different regulatory classes.	Repair costs use a 2021 study by the American Transportation Research Institute (ATRI) in place of the Fleet Advantage Whitepaper.
Fuel prices .....	Used AEO2018 fuel prices in 2017 dollars .....	Uses AEO2019 fuel prices for consistency with the final rule version of the MOVES model while continuing with 2017 dollars.
Technology piece costs	Exhaust aftertreatment system (EAS) costs were based on an ICCT methodology with updates by EPA.	EAS costs have been updated and are based on FEV teardowns as described in RIA Chapter 3.

A. Technology Package Costs

Commenters’ primary comment with respect to our proposed technology package costs dealt with the need to replace the emission control system due to the combination of the low NO<sub>x</sub> standards with the long warranty and useful life provisions under proposed Option 1. Another comment with respect to our proposed technology package costs dealt with the estimated warranty costs, including both the methodology used and the magnitude of the cost estimated by EPA. As explained in Sections III and IV, the final program neither imposes numeric NO<sub>x</sub> standards as stringent as, nor does the final rule for heavy HDE contain warranty and useful life provisions as long as, proposed Option 1. We address these comments in more detail in section 18 of the RTC. EPA considers the concerns raised in first of these comments to be obviated by the final emission standards and regulatory useful life values, in light of which we foresee no need for a routine replacement of the entire emission control system to maintain in-use compliance as suggested by some commenters. Regarding the second, as discussed in more detail in Section V.A.2 and section 18 of the RTC, EPA has updated the warranty cost methodology, including based on information submitted by commenters, and this has resulted in different costs associated with warranty.

Individual technology piece costs are presented in Chapter 3 of the RIA. The direct manufacturing costs (DMC) presented in RIA Chapter 3 use a different dollar basis than the cost analysis, and as such, the DMC values presented here have been adjusted to 2017 dollars. Following the first year of implementation, the costs also account for a learning effect to represent the cost

reductions expected to occur via the “learning by doing” phenomenon.<sup>433</sup> This provides a year-over-year cost for each technology package—where a technology package consists of the entire emission-control system—as it is applied to new engine sales. We then apply industry standard “retail price equivalent” (RPE) markup factors, with adjustments discussed in the rest of this section, to estimate indirect costs associated with each technology package. Both the learning effects applied to direct costs and the application of markup factors to estimate indirect costs are consistent with the cost estimation approaches used in EPA’s past transportation-related regulatory programs. The sum of the direct and indirect costs represents our estimate of technology costs per vehicle on a year-over-year basis. These technology costs multiplied by estimated sales then represent the total technology costs associated with the final program.

This cost calculation approach presumes that the expected technologies will be purchased by original equipment manufacturers (OEMs) from their suppliers. So, while the DMC estimates include the indirect costs and profits incurred by the supplier, the indirect cost markups we apply cover the indirect costs incurred by OEMs to incorporate the new technologies into their vehicles and to cover profit margins typical of the heavy-duty truck industry. We discuss the indirect costs in more detail in Section V.A.2.

<sup>433</sup> The “learning by doing” phenomenon is the process by which the cost to manufacture a good decreases as more of that good is produced, as producers of the good learn from their experience.

1. Direct Manufacturing Costs

To produce a unit of output, manufacturers incur direct and indirect costs. Direct costs include cost of materials and labor costs to manufacture that unit. Indirect costs are discussed in the following section. The direct manufacturing costs presented here include individual technology costs for emission-related engine components and exhaust aftertreatment systems (EAS).

Notably, for this analysis we include not only the marginal increased costs associated with the standards, but also the emission control system costs for the baseline, or no action, case.<sup>434</sup> Throughout this discussion, we refer to baseline case costs, or baseline costs, which reflect our cost estimate of emission-related engine systems and the exhaust aftertreatment system absent impacts of this final rule. This inclusion of baseline system costs contrasts with EPA’s approach in recent greenhouse gas rules or the light-duty Tier 3 criteria pollutant rule where we estimated costs relative to a baseline case, which obviated the need to estimate baseline costs. We have included baseline costs in this analysis because the new emissions warranty and regulatory useful life provisions are expected to have some impact on not only the new technology added to comply with the final standards, but also on emission control technologies already developed and in use. The new warranty and useful life provisions will increase costs not only for the new technology added in response to the new standards, but also for the technology already in place

<sup>434</sup> For this cost analysis, the baseline, or no action, case consists of MY 2019 engines and emission control systems. See also Section VI for more information about the emission inventory baseline and how that baseline is characterized.

(to which the new technology is added) because the new warranty and useful life provisions will apply to the entire emission-control system, not just the new technology added in response to the new standards. The baseline direct manufacturing costs detailed in this section are intended to reflect that portion of baseline case engine hardware and aftertreatment systems for which new indirect costs will be incurred due to the new warranty and useful life provisions, even apart from changes in the level of emission standards.

As done in the NPRM, we have estimated the baseline engine costs based on studies done by the International Council on Clean

Transportation (ICCT), as discussed in more detail in Chapter 7 of the RIA. As discussed there, the baseline engine costs consist of turbocharging, fuel system, exhaust gas recirculation, etc. These costs represent those for technologies that will be subject to new, longer warranty and useful life provisions under this final rule. For costs associated with the action case, we have used FEV-conducted teardown-based costs as presented in Chapter 3 of the RIA for newly added cylinder deactivation systems,<sup>435</sup> and for the exhaust aftertreatment system (EAS) costs.<sup>436</sup> The direct manufacturing costs for the baseline engine+aftertreatment and for the final program are shown for diesel engines in Table V–2, gasoline

engines in Table V–3 and CNG engines in Table V–4. Costs are shown for regulatory classes included in the cost analysis and follow the categorization approach used in our MOVES model. Please refer to Chapter 6 of the RIA for a description of the regulatory classes and why the tables that follow include or do not include each regulatory class. In short, where MOVES has regulatory class populations and associated emission inventories, our cost analysis estimates costs. Note also that, throughout this section, we use several acronyms, including heavy-duty engine (HDE), exhaust gas recirculation (EGR), exhaust aftertreatment system (EAS), and compressed natural gas (CNG).

TABLE V–2—DIESEL TECHNOLOGY AND PACKAGE DIRECT MANUFACTURING COSTS PER ENGINE BY REGULATORY CLASS FOR THE BASELINE AND FINAL PROGRAM, MY2027, 2017 DOLLARS

MOVES regulatory class	Technology	Baseline	Final program (MY2027 increment to baseline)
Light HDE .....	Package .....	3,699	1,957
	Engine hardware .....	1,097	0
	Closed crankcase .....	18	37
	Cylinder deactivation .....	0	196
	EAS .....	2,585	1,724
Medium HDE .....	Package .....	3,808	1,817
	Engine hardware .....	1,254	0
	Closed crankcase .....	18	37
	Cylinder deactivation .....	0	147
	EAS .....	2,536	1,634
Heavy HDE .....	Package .....	5,816	2,316
	Engine hardware .....	2,037	0
	Closed crankcase .....	18	37
	Cylinder deactivation .....	0	206
	EAS .....	3,761	2,074
Urban bus .....	Package .....	3,884	1,850
	Engine hardware .....	1,254	0
	Closed crankcase .....	18	37
	Cylinder deactivation .....	0	147
	EAS .....	2,613	1,666

TABLE V–3—GASOLINE TECHNOLOGY AND PACKAGE DIRECT MANUFACTURING COSTS PER ENGINE BY REGULATORY CLASS FOR THE BASELINE AND FINAL PROGRAM, MY2027, 2017 DOLLARS

MOVES regulatory class	Technology	Baseline	Final program (MY2027 increment to baseline)
Light HDE .....	Package .....	2,681	688
	Engine hardware .....	522	0
	Aftertreatment .....	2,158	664
	ORVR .....	0	24
Medium HDE .....	Package .....	2,681	688
	Engine hardware .....	522	0
	Aftertreatment .....	2,158	664
	ORVR .....	0	24
Heavy HDE .....	Package .....	2,681	688
	Engine hardware .....	522	0
	Aftertreatment .....	2,158	664
	ORVR .....	0	24

<sup>435</sup> Mamidanna, S. 2021. Heavy-Duty Engine Valvetrain Technology Cost Assessment. U.S. EPA Contract with FEV North America, Inc., Contract

No. 68HERC19D0008, Task Order No. 68HERH20F0041. Submitted to the Docket with the proposal.

<sup>436</sup> Mamidanna, S. 2021. Heavy-Duty Vehicles Aftertreatment Systems Cost Assessment. Submitted to the Docket with the proposal.

TABLE V-4—CNG TECHNOLOGY AND PACKAGE DIRECT MANUFACTURING COSTS PER ENGINE BY REGULATORY CLASS, FOR THE BASELINE AND FINAL PROGRAM, MY2027, 2017 DOLLARS

MOVES regulatory class	Technology	Baseline	Final standards (MY2027 increment to baseline)
Heavy HDE .....	Package .....	8,585	25
	Engine hardware .....	896	0
	Aftertreatment .....	7,689	25
Urban bus .....	Package .....	6,438	19
	Engine hardware .....	672	0
	Aftertreatment .....	5,766	19

The direct costs are then adjusted to account for learning effects going forward from the first year of implementation. We describe in detail in Chapter 7 of the RIA the approach used to apply learning effects in this analysis. Learning effects were applied on a technology package cost basis, and MOVES-projected sales volumes were used to determine first-year sales and cumulative sales. The resultant direct manufacturing costs and how those costs decrease over time are presented in Section V.A.3.

2. Indirect Costs

The indirect costs presented here are all the costs estimated to be incurred by manufacturers of new heavy-duty engines and vehicles associated with producing the unit of output that are not direct costs. For example, they may be related to production (such as research and development (R&D)), corporate operations (such as salaries, pensions, and health care costs for corporate staff), or selling (such as transportation, dealer support, and marketing). Indirect costs

are generally recovered by allocating a share of the indirect costs to each unit of good sold. Although direct costs can be allocated to each unit of good sold, it is more challenging to account for indirect costs allocated to a unit of goods sold. To ensure that regulatory analyses capture the changes in indirect costs, markup factors (which relate total indirect costs to total direct costs) have been developed and used by EPA and other stakeholders. These factors are often referred to as retail price equivalent (RPE) multipliers. RPE multipliers provide, at an aggregate level, the relative shares of revenues, where:

$$\begin{aligned} \text{Revenue} &= \text{Direct Costs} + \text{Indirect Costs} \\ \text{Revenue/Direct Costs} &= 1 + \text{Indirect Costs/Direct Costs} = \text{Retail Price Equivalent (RPE)} \end{aligned}$$

Resulting in:  
 $\text{Indirect Costs} = \text{Direct Costs} \times (\text{RPE} - 1)$   
 If the relationship between revenues and direct costs (*i.e.*, RPE) can be shown to equal an average value over time, then an estimate of direct costs can be multiplied by that average value to

estimate revenues, or total costs. Further, that difference between estimated revenues, or total costs, and estimated direct costs can be taken as the indirect costs. EPA has frequently used these multipliers<sup>437</sup> to predict the resultant impact on costs associated with manufacturers' responses to regulatory requirements and we are using that approach in this analysis to account for most of the indirect cost contributions. The exception is the warranty cost as described in this section.

The cost analysis estimates indirect costs by applying the RPE markup factor used in past rulemakings (such as those setting greenhouse gas standards for heavy-duty trucks).<sup>438</sup> The markup factors are based on financial filings with the Securities and Exchange Commission for several engine and engine/truck manufacturers in the heavy-duty industry.<sup>439</sup> The RPE factors for the HD truck industry are shown in Table V-5. Also shown in Table V-5 are the RPE factors for light-duty vehicle manufacturers.<sup>440</sup>

TABLE V-5—RETAIL PRICE EQUIVALENT FACTORS IN THE HEAVY-DUTY AND LIGHT-DUTY INDUSTRIES

Cost contributor	HD truck industry	LD vehicle industry
Direct manufacturing cost .....	1.00	1.00
Warranty .....	0.03	0.03
R&D .....	0.05	0.05
Other (admin, retirement, health, etc.) .....	0.29	0.36
Profit (cost of capital) .....	0.05	0.06
RPE .....	1.42	1.50

For this analysis, EPA based indirect cost estimates for diesel and CNG regulatory classes on the HD Truck Industry RPE values shown in Table V-5.<sup>441</sup> For gasoline regulatory classes, we used the LD Vehicle Industry values shown in Table V-5 since they more

closely represent the cost structure of manufacturers in that industry—Ford, General Motors, and Stellantis.

Of the cost contributors listed in Table V-5, Warranty and R&D are the elements of indirect costs that the final rule requirements are expected to

impact. As discussed in Section IV of this preamble, EPA is lengthening the required warranty period, which we expect to increase the contribution of warranty costs to indirect costs. EPA is also tightening the numeric standards and extending the regulatory useful life,

<sup>437</sup> See 75 FR 25324, 76 FR 57106, 77 FR 62624, 79 FR 23414, 81 FR 73478, 86 FR 74434.

<sup>438</sup> 76 FR 57106; 81 FR 73478.

<sup>439</sup> Heavy Duty Truck Retail Price Equivalent and Indirect Cost Multipliers, Draft Report, July 2010.

<sup>440</sup> Rogozhin, A., et al., Using indirect cost multipliers to estimate the total cost of adding new technology in the automobile industry. International Journal of Production Economics (2009), doi:10.1016/j.ijpe.2009.11.031.

<sup>441</sup> Note that the report used the term "HD Truck" while EPA generally uses the term "HD vehicle;" they are equivalent when referring to this report.

which we expect to result in increased R&D expenses as compliant systems are developed. All other indirect cost elements—those encapsulated by the “Other” category, including General and Administrative Costs, Retirement Costs, Healthcare Costs, and other overhead costs—as well as Profits, are expected to scale according to their historical levels of contribution.

As mentioned, Warranty and R&D are the elements of indirect costs that are expected to be impacted. Warranty expenses are the costs that a business expects to or has already incurred for the repair or replacement of goods that it has sold. The total amount of warranty expense is limited by the warranty period that a business

typically allows. After the warranty period for a product has expired, a business no longer incurs a warranty liability; thus, a longer warranty period results in a longer period of liability for a product. At the time of sale, a warranty liability account is adjusted to reflect the expected costs of any potential future warranty claims. If and when warranty claims are made by customers, the warranty liability account is debited and a warranty claims account is credited to cover warranty claim expenses.<sup>442</sup>

In the proposed analysis, to address the expected increased indirect cost contributions associated with warranty (increased funding of the warranty liability account) due to the proposed

longer warranty requirements, we applied scaling factors commensurate with the changes in proposed Option 1 or Option 2 to the number of miles included in the warranty period (*i.e.*, VMT-based scaling factors). Industry commenters took exception to this approach, arguing that it resulted in underestimated costs associated with warranty. To support their comments, one commenter submitted data that showed costs associated with actual warranty claims for roughly 250,000 heavy heavy-duty vehicles. The following figure includes the chart from their comments, which are also in the public docket for this rule.

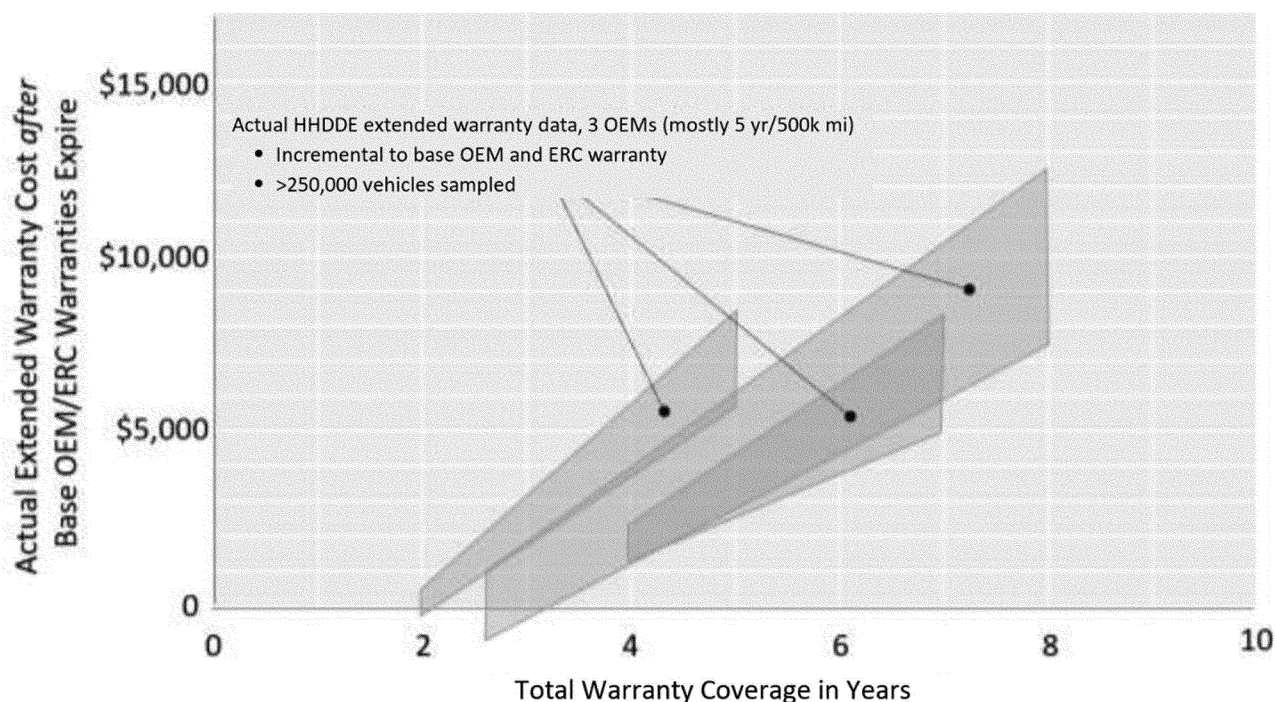

**Figure V-1 Warranty Costs Submitted as Part of the Comments From An Industry Association; See EPA-HQ-OAR-2019-0055-1203-A1, Page 151**

EPA considers this comment and supporting information to be persuasive, not only because it represents data, but also because it represents data from three manufacturers and over 250,000 vehicles; thus, we switched from a VMT-based scaling approach to a years-based approach to better take into account this information. However, the data are for heavy HDE, so it is not possible to determine an appropriate

cost per year for light or medium HDE from the data directly. Also, the data represent actual warranty claims without any mention of the warranty claims rate (*i.e.*, the share of engines sold that are making the warranty claims represented in the data). This latter issue makes it difficult to determine the costs that might be imposed on all new engines sold to cover the future warranty claims for the relatively smaller fraction of engines that incur warranty repair. In other words, if all heavy HDE purchases are helping to fund a warranty liability account, it is unclear if the \$1,000 per

year per engine is the right amount or if \$1,000 per year is needed on only that percent of engines that will incur warranty repair. In the end, warranty costs imposed on new engine sales should be largely recouped by purchasers of those engines in the form of reduced emission repair expenses. EPA believes it is unlikely that a manufacturer would use their warranty program as a profit generator under the \$1,000 per engine approach, especially in a market as competitive as the HD engine and vehicle industry. The possibility exists that the costs associated with the longer warranty

<sup>442</sup> Warranty expense is recognized in the same period as the sales for the products that were sold, if it is probable that an expense will be incurred and

the company can estimate the amount of the expense. For more discussion of this topic, see the supporting material in this docket,

*AccountingTools.com*, December 24, 2020, accessed January 28, 2021.



coverage required by this rule will (1) converge towards those of the better performing OEMs; and (2) drop over time via something analogous to the learning by doing phenomenon described earlier. If true, we have probably overestimated the costs estimated here as attributable to this rule.

Thus, after careful consideration of these comments regarding warranty, and the engineering judgement of EPA

subject matter experts, we revised our approach to estimating warranty costs, and for the final rule we have estimated warranty costs assuming a cost of \$1,000 (2018 dollars or \$977 in 2017 dollars) per estimated number of years of warranty coverage for a heavy heavy-duty diesel engine or heavy-duty vehicle equipped with such an engine. For other regulatory (engine) classes, we have scaled that value by the ratio of their estimated baseline emission-

control system direct cost to the estimated emission-control system direct cost of the baseline heavy heavy-duty diesel engine. We use the baseline heavy heavy-duty diesel engine direct cost here because it should be consistent with the data behind the \$1,000 per year value. The resulting emission-related warranty costs per year for a MY 2027 HD engine are as shown in Table V-6.

TABLE V-6—WARRANTY COSTS PER YEAR [2017 Dollars]<sup>a</sup>

MOVES regulatory class	Scaling approach	Diesel	Gasoline	CNG
Light HDE .....	Base Light HDE DMC/Base Diesel Heavy HDE DMC .....	621	450	.....
Medium HDE .....	Base Medium HDE DMC/Base Diesel Heavy HDE DMC .....	639	449	.....
Heavy HDE .....	Base Heavy HDE DMC/Base Diesel Heavy HDE DMC .....	977	448	1,442
Urban bus .....	Base Urban bus DMC/Base Diesel Heavy HDE DMC .....	652	.....	1,081

<sup>a</sup> The Base Diesel HDE DMC would be the \$5,816 value shown in Table V-2.

As noted, we have used the estimated number of years of warranty coverage, not the regulated number of years. In other words, a long-haul tractor accumulating over 100,000 miles per year will reach any regulated warranty mileage prior to a refuse truck accumulating under 40,000 miles per year, assuming both are in the same regulatory class and, therefore, have the same warranty provisions. In all cases, we estimate the number of years of warranty coverage by determining the minimum number of years to reach either the number of years, the number of miles, or the number of hours of operation covered by the EPA emissions-related warranty. We provide more detail on this in Chapter 7 of the final RIA.

Lastly, with respect to warranty, we have estimated that many of the regulated products are sold today with a warranty period longer than the EPA required emissions-related warranty period. In the proposal, we calculated baseline warranty costs only for the required warranty periods. In the final

analysis, we calculate baseline warranty costs based on the warranty periods for which engines are actually sold. For diesel and CNG heavy HDE, we assume all are sold with warranties covering 250,000 miles, and for diesel and CNG medium HDE, we assume half are sold with warranties covering 150,000 miles. For all other engines and associated fuel types, we have not estimated any use of extended warranties in the baseline.

We use these annual warranty costs for both the baseline and the final standards despite the addition of new technology associated with this final rule. We believe this is reasonable for two reasons: (1) The source data included several years of data during which there must have been new technology introductions, yet annual costs appear to have remained generally steady; and, (2) the R&D we expect to be done, discussed next, is expected to improve overall durability, which should serve to help maintain historical annual costs.

For R&D, we have maintained the approach used in the proposal, although

it is applied using the final useful life provisions. For example, for R&D on a Class 8 truck, the final standards would extend regulatory useful life from 10 years, 22,000 hours, or 435,000 miles, to 11 years, 32,000 hours, or 650,000 miles. We have applied a scaling factor of 1.49 (650/435) to the 0.05 R&D contribution factor for MYs 2027 and later. We apply this same methodology to estimating R&D for other vehicle categories. We estimate that once the development efforts into longer useful life are complete, increased expenditures will return to their normal levels of contribution. Therefore, we have implemented R&D scalars for three years (2027 through 2029). In MY 2030 and later, the R&D scaling factors are no longer applied.

The VMT-based scaling factors applied to R&D cost contributors used in our cost analysis of final standards are shown in Table V-7 for diesel and CNG regulatory classes and in Table V-8 for gasoline regulatory classes.

TABLE V-7—SCALING FACTORS APPLIED TO RPE CONTRIBUTION FACTORS TO REFLECT CHANGES IN THEIR CONTRIBUTIONS, DIESEL & CNG REGULATORY CLASSES

Scenario	MOVES regulatory class	R&D scalars	
		MY2027-2029	MY2030+
Baseline .....	Light HDE .....	1.00	1.00
	Medium HDE .....	1.00	1.00
	Heavy HDE .....	1.00	1.00
	Urban Bus .....	1.00	1.00
Final Program .....	Light HDE .....	2.45	1.00
	Medium HDE .....	1.89	1.00
	Heavy HDE .....	1.49	1.00
	Urban Bus .....	1.49	1.00

TABLE V-8—SCALING FACTORS APPLIED TO RPE CONTRIBUTION FACTORS TO REFLECT CHANGES IN THEIR CONTRIBUTIONS, GASOLINE REGULATORY CLASSES

Scenario	MOVES regulatory class	R&D scalars	
		MY2027–2029	MY2030+
Baseline	Light HDE	1.00	1.00
	Medium HDE	1.00	1.00
	Heavy HDE	1.00	1.00
Final Program	Light HDE	1.82	1.00
	Medium HDE	1.82	1.00
	Heavy HDE	1.82	1.00

Lastly, as mentioned in Section V.A.1, the markups for estimating indirect costs are applied to our estimates of the absolute direct manufacturing costs for emission-control technology shown in Table V-2, Table V-3 and Table V-4, not just the incremental costs associated with the final program (*i.e.*, the Baseline

+ Final costs). Table V-9 provides an illustrative example using a baseline technology cost of \$5000, a final incremental cost of \$1000, and an indirect cost R&D contribution of 0.05 with a simple scalar of 1.5 associated with a longer useful life period. In this case, the costs could be calculated

according to two approaches, as shown in Table V-9. By including the baseline costs, we are estimating new R&D costs in the final standards, as illustrated by the example where including baseline costs results in R&D costs of \$450 while excluding baseline costs results in R&D costs of \$75.

TABLE V-9—SIMPLIFIED HYPOTHETICAL EXAMPLE OF INDIRECT R&D COSTS CALCULATED ON AN INCREMENTAL VS. ABSOLUTE TECHNOLOGY PACKAGE COST

[Values are not from the analysis and are for presentation only]

	Using incremental costs only	Using absolute costs
Baseline direct manufacturing cost (DMC)	\$5,000	\$5,000.
Direct Manufacturing Cost (DMC)	\$1,000	\$5,000 + \$1,000 = \$6,000.
Indirect R&D Costs	$\$1,000 \times 0.05 \times 1.5 = \$75$	$\$6,000 \times 0.05 \times 1.5 = \$450.$
Incremental DMC + R&D	$\$1,000 + \$75 = \$1,075$	$\$6,000 + \$450 - \$5,000 = \$1,450.$

3. Technology Costs per Vehicle

The following tables present the technology costs estimated for the final program on a per-vehicle basis for MY 2027. Reflected in these tables are learning effects on direct manufacturing costs and scaling effects associated with final program requirements. The sum is also shown and reflects the direct plus indirect cost per vehicle in the specific model year. Note that the indirect costs shown include warranty, R&D, “other,” and profit, the latter two which scale with direct costs via the indirect cost contribution factor. While direct costs do not change across the different vehicle types (*i.e.*, long-haul versus short-haul combination), the indirect costs do vary because differing miles driven and operating hours between

types of vehicles result in different warranty and useful life estimates in actual use. These differences impact the estimated warranty and R&D costs.

We show costs per vehicle here, but it is important to note that these are costs and not prices. We are not estimating how manufacturers might price their products. Manufacturers may pass costs along to purchasers via price increases in a manner consistent with what we show here. However, manufacturers may also price certain products higher than what we show while pricing others lower—the higher-priced products thereby subsidizing the lower-priced products. This is true in any market, not just the heavy-duty highway industry. This may be especially true with respect to the

indirect costs we have estimated because, for example, R&D done to improve emission durability can readily transfer across different engines whereas hardware added to an engine is uniquely tied to that engine.

Importantly, we present costs here for MY2027 vehicles, but these costs continue for every model year going forward from there. Consistent with the learning impacts described in section V.A.2, the costs per vehicle decrease slightly over time, but only the increased R&D costs are expected to decrease significantly. Increased R&D is estimated to occur for three years following and including MY2027 (*i.e.*, MY2027–29), after which time its contribution to indirect costs returns to lower values as shown in Table V.4.

TABLE V-10—MY2027 DIESEL LIGHT HDE TECHNOLOGY COSTS PER VEHICLE ASSOCIATED WITH THE FINAL PROGRAM, 2017 DOLLARS

	Direct costs	Indirect costs	Costs per vehicle
<b>FRM Baseline</b>			
Long-Haul Single Unit Trucks	3,699	2,332	6,031
Other Buses	3,699	2,263	5,962
School Buses	3,699	3,829	7,528
Short-Haul Single Unit Trucks	3,699	2,851	6,550
Transit Buses	3,699	2,263	5,962

TABLE V-10—MY2027 DIESEL LIGHT HDE TECHNOLOGY COSTS PER VEHICLE ASSOCIATED WITH THE FINAL PROGRAM, 2017 DOLLARS—Continued

	Direct costs	Indirect costs	Costs per vehicle
<b>FRM Baseline + Final Program</b>			
Long-Haul Single Unit Trucks .....	5,656	6,353	12,009
Other Buses .....	5,656	6,064	11,720
School Buses .....	5,656	8,830	14,485
Short-Haul Single Unit Trucks .....	5,656	8,530	14,186
Transit Buses .....	5,656	6,064	11,720
<b>Increased Cost of the Final Program</b>			
Long-Haul Single Unit Trucks .....	1,957	4,021	5,978
Other Buses .....	1,957	3,800	5,757
School Buses .....	1,957	5,001	6,957
Short-Haul Single Unit Trucks .....	1,957	5,680	7,636
Transit Buses .....	1,957	3,800	5,757

TABLE V-11—MY2027 DIESEL MEDIUM HDE TECHNOLOGY COSTS PER VEHICLE ASSOCIATED WITH THE FINAL PROGRAM, 2017 DOLLARS

	Direct costs	Indirect costs	Costs per vehicle
<b>FRM Baseline</b>			
Long-Haul Single Unit Trucks .....	3,808	3,774	7,582
Motor Homes .....	3,808	4,682	8,490
Other Buses .....	3,808	3,597	7,404
Refuse Trucks .....	3,808	4,217	8,025
School Buses .....	3,808	4,682	8,490
Short-Haul Combination Trucks .....	3,808	2,595	6,402
Short-Haul Single Unit Trucks .....	3,808	4,682	8,490
Transit Buses .....	3,808	3,597	7,404
<b>FRM Baseline + Final Program</b>			
Long-Haul Single Unit Trucks .....	5,625	7,572	13,197
Motor Homes .....	5,625	8,839	14,464
Other Buses .....	5,625	7,175	12,799
Refuse Trucks .....	5,625	8,564	14,189
School Buses .....	5,625	8,839	14,464
Short-Haul Combination Trucks .....	5,625	4,930	10,555
Short-Haul Single Unit Trucks .....	5,625	8,839	14,464
Transit Buses .....	5,625	7,175	12,799
<b>Increased Cost of the Final Program</b>			
Long-Haul Single Unit Trucks .....	1,817	3,798	5,615
Motor Homes .....	1,817	4,157	5,974
Other Buses .....	1,817	3,578	5,395
Refuse Trucks .....	1,817	4,347	6,164
School Buses .....	1,817	4,157	5,974
Short-Haul Combination Trucks .....	1,817	2,335	4,153
Short-Haul Single Unit Trucks .....	1,817	4,157	5,974
Transit Buses .....	1,817	3,578	5,395

TABLE V-12—MY2027 DIESEL HEAVY HDE TECHNOLOGY COSTS PER VEHICLE ASSOCIATED WITH THE FINAL PROGRAM, 2017 DOLLARS

	Direct costs	Indirect costs	Costs per vehicle
<b>FRM Baseline</b>			
Long-Haul Combination Trucks .....	5,816	4,025	9,841
Long-Haul Single Unit Trucks .....	5,816	7,151	12,967
Motor Homes .....	5,816	7,151	12,967
Other Buses .....	5,816	7,151	12,967
Refuse Trucks .....	5,816	7,151	12,967
School Buses .....	5,816	7,151	12,967
Short-Haul Combination Trucks .....	5,816	5,658	11,473

TABLE V-12—MY2027 DIESEL HEAVY HDE TECHNOLOGY COSTS PER VEHICLE ASSOCIATED WITH THE FINAL PROGRAM, 2017 DOLLARS—Continued

	Direct costs	Indirect costs	Costs per vehicle
Short-Haul Single Unit Trucks .....	5,816	7,151	12,967
<b>FRM Baseline + Final Program</b>			
Long-Haul Combination Trucks .....	8,132	6,535	14,667
Long-Haul Single Unit Trucks .....	8,132	13,139	21,271
Motor Homes .....	8,132	13,139	21,271
Other Buses .....	8,132	13,139	21,271
Refuse Trucks .....	8,132	13,139	21,271
School Buses .....	8,132	13,139	21,271
Short-Haul Combination Trucks .....	8,132	9,474	17,606
Short-Haul Single Unit Trucks .....	8,132	13,139	21,271
<b>Increased Cost of the Final Program</b>			
Long-Haul Combination Trucks .....	2,316	2,510	4,827
Long-Haul Single Unit Trucks .....	2,316	5,988	8,304
Motor Homes .....	2,316	5,988	8,304
Other Buses .....	2,316	5,988	8,304
Refuse Trucks .....	2,316	5,988	8,304
School Buses .....	2,316	5,988	8,304
Short-Haul Combination Trucks .....	2,316	3,816	6,132
Short-Haul Single Unit Trucks .....	2,316	5,988	8,304

TABLE V-13—MY2027 DIESEL URBAN BUS TECHNOLOGY COSTS PER VEHICLE ASSOCIATED WITH THE FINAL PROGRAM, 2017 DOLLARS

	Direct costs	Indirect costs	Costs per vehicle
FRM Baseline .....	3,884	3,238	7,122
FRM Baseline + Final Program .....	5,734	8,901	14,635
Increased Cost of the Final Program .....	1,850	5,663	7,512

TABLE V-14—MY2027 GASOLINE HDE TECHNOLOGY COSTS PER VEHICLE ASSOCIATED WITH THE FINAL PROGRAM, 2017 DOLLARS

	Direct costs	Indirect costs	Costs per vehicle
<b>FRM Baseline</b>			
Long-Haul Single Unit Trucks .....	2,681	1,905	4,585
Motor Homes .....	2,681	3,511	6,192
Other Buses .....	2,681	1,855	4,535
School Buses .....	2,681	2,989	5,670
Short-Haul Single Unit Trucks .....	2,681	2,280	4,961
Transit Buses .....	2,681	1,855	4,535
<b>FRM Baseline + Final Program</b>			
Long-Haul Single Unit Trucks .....	3,369	3,784	7,153
Motor Homes .....	3,369	6,223	9,592
Other Buses .....	3,369	3,624	6,993
School Buses .....	3,369	6,223	9,592
Short-Haul Single Unit Trucks .....	3,369	4,986	8,355
Transit Buses .....	3,369	3,624	6,993
<b>Increased Cost of the Final Program</b>			
Long-Haul Single Unit Trucks .....	688	1,880	2,568
Motor Homes .....	688	2,712	3,401
Other Buses .....	688	1,770	2,458
School Buses .....	688	3,234	3,923
Short-Haul Single Unit Trucks .....	688	2,706	3,394
Transit Buses .....	688	1,770	2,458

TABLE V-15—MY2027 CNG HEAVY HDE TECHNOLOGY COSTS PER VEHICLE ASSOCIATED WITH THE FINAL PROGRAM, 2017 DOLLARS

	Direct costs	Indirect costs	Costs per vehicle
<b>FRM Baseline</b>			
Long-Haul Single Unit Trucks .....	8,585	10,556	19,141
Other Buses .....	8,585	10,556	19,141
Refuse Trucks .....	8,585	10,556	19,141
School Buses .....	8,585	10,556	19,141
Short-Haul Combination Trucks .....	8,585	8,351	16,936
Short-Haul Single Unit Trucks .....	8,585	10,556	19,141
<b>FRM Baseline + Final Program</b>			
Long-Haul Single Unit Trucks .....	8,610	17,988	26,598
Other Buses .....	8,610	17,988	26,598
Refuse Trucks .....	8,610	17,988	26,598
School Buses .....	8,610	17,988	26,598
Short-Haul Combination Trucks .....	8,610	12,577	21,187
Short-Haul Single Unit Trucks .....	8,610	17,988	26,598
<b>Increased Cost of the Final Program</b>			
Long-Haul Single Unit Trucks .....	25	7,431	7,457
Other Buses .....	25	7,431	7,457
Refuse Trucks .....	25	7,431	7,457
School Buses .....	25	7,431	7,457
Short-Haul Combination Trucks .....	25	4,225	4,251
Short-Haul Single Unit Trucks .....	25	7,431	7,457

TABLE V-16—MY2027 CNG URBAN BUS TECHNOLOGY COSTS PER VEHICLE ASSOCIATED WITH THE FINAL PROGRAM, 2017 DOLLARS

	Direct costs	Indirect costs	Costs per vehicle
FRM Baseline .....	6,438	5,367	11,806
FRM Baseline + Final Program .....	6,457	13,490	19,948
Increased Cost of the Final Program .....	19	8,123	8,142

*B. Operating Costs*

We have estimated three impacts on operating costs expected to be incurred by users of new MY 2027 and later heavy-duty vehicles: Increased diesel exhaust fluid (DEF) consumption by diesel vehicles due to increased DEF dose rates to enable compliance with more stringent NO<sub>x</sub> standards; decreased fuel costs for gasoline vehicles due to new onboard refueling vapor recovery systems that allow burning (in engine) of otherwise evaporated hydrocarbon emissions; emission repair impacts brought about by longer warranty and useful life provisions; and the potential higher emission-related repair costs for vehicles equipped with the new technology. For the repair impacts, we expect that the longer duration warranty period will result in lower owner/operator-incurred repair costs due to fewer repairs being paid for by owners/operators since more costs will be borne by the manufacturer, and that the longer duration useful life periods will result in increased emission control system

durability. We have estimated the net effect on repair costs and describe our approach, along with increased DEF consumption and reduced gasoline consumption, in this section. Additional details on our methodology and estimates of operating costs are included in RIA Chapter 7.2.

1. Costs Associated With Increased Diesel Exhaust Fluid (DEF) Consumption in Diesel Engines

Consistent with the approach used to estimate technology costs, we have estimated both baseline case DEF consumption and DEF consumption under the final program. For the baseline case, we estimated DEF consumption using the relationship between DEF dose rate and the reduction in NO<sub>x</sub> over the SCR catalyst. The relationship between DEF dose rate and NO<sub>x</sub> reduction across the SCR catalyst is based on methodology presented in the Technical Support Document to the 2012 Nonconformance Penalty rule (the NCP Technical

Support Document, or NCP TSD).<sup>443</sup> The relationship of DEF dose rate to NO<sub>x</sub> reduction used in that methodology considered FTP emissions and, as such, the DEF dose rate increased as FTP tailpipe emissions decreased. The DEF dose rate used in this analysis is 5.18 percent of fuel consumed.

To estimate DEF consumption impacts under the final program, which involves not only the new FTP emission standards but also the new SET and LLC standards along with new off-cycle standards, we developed a new approach to estimate DEF consumption for the proposal, which we also applied in this final rule. For this analysis, we scaled DEF consumption with the NO<sub>x</sub> reductions achieved under the final emission standards. This was done by considering the molar mass of NO<sub>x</sub>, the molar mass of urea, the mass concentration of urea in DEF, along with the density of DEF, to estimate the

<sup>443</sup> Nonconformance Penalties for On-highway Heavy-duty Diesel Engines: Technical Support Document; EPA-420-R-12-014, August 2012.

theoretical gallons of DEF consumed per ton of NO<sub>x</sub> reduced. We estimated theoretical DEF consumption per ton of NO<sub>x</sub> reduced at 442 gallons/ton, which we then adjusted based on testing to 527 gallons/ton, the value used in this analysis. We describe this in more detail in Section 7.2.1 of the RIA.

These two DEF consumption metrics—dose rate per gallon for an engine meeting the baseline emission standards and any additional DEF consumption per ton of NO<sub>x</sub> reduced to achieve the final emission standards over the final useful lives—were used to estimate total DEF consumption. These DEF consumption rates were then

multiplied by DEF price per gallon, adjusted to 2017 dollars from the DEF prices presented in the NCP TSD, to arrive at the impacts on DEF costs for diesel engines. These are shown for MY2027 diesel vehicles in Table V–17. Because these are operating costs which occur over time, we present them at both 3 and 7 percent discount rates.

TABLE V–17—MY2027 LIFETIME DEF COSTS PER DIESEL VEHICLE ASSOCIATED WITH FINAL NO<sub>x</sub> STANDARDS, 2017 DOLLARS

	3% Discount rate				7% Discount rate			
	Light HDE	Medium HDE	Heavy HDE	Urban bus	Light HDE	Medium HDE	Heavy HDE	Urban bus
<b>FRM Baseline</b>								
Long-Haul Combination Trucks .....			34,009				25,768	
Long-Haul Single Unit Trucks .....	3,759	5,686	6,823		2,937	4,443	5,331	
Motor Homes .....		1,489	1,764			1,068	1,265	
Other Buses .....	9,118	11,285	11,688		6,695	8,286	8,582	
Refuse Trucks .....		8,435	8,787			6,317	6,581	
School Buses .....	2,331	3,030	3,187		1,712	2,225	2,340	
Short-Haul Combination Trucks .....		16,323	17,154			12,735	13,384	
Short-Haul Single Unit Trucks .....	2,733	4,144	4,975		2,100	3,184	3,823	
Transit Buses .....	9,192	11,254		11,742	6,750	8,263		8,622
<b>FRM Baseline + Final Program</b>								
Long-Haul Combination Trucks .....			37,621				28,580	
Long-Haul Single Unit Trucks .....	4,011	6,215	7,916		3,136	4,865	6,200	
Motor Homes .....		1,617	2,016			1,162	1,450	
Other Buses .....	9,805	12,277	13,594		7,209	9,040	10,011	
Refuse Trucks .....		9,182	10,246			6,895	7,696	
School Buses .....	2,501	3,293	3,671		1,839	2,424	2,702	
Short-Haul Combination Trucks .....		17,575	19,378			13,727	15,154	
Short-Haul Single Unit Trucks .....	2,949	4,573	5,864		2,268	3,522	4,517	
Transit Buses .....	9,867	12,149		13,410	7,253	8,945		9,863
<b>Increased Cost of the Final Program</b>								
Long-Haul Combination Trucks .....			3,612				2,812	
Long-Haul Single Unit Trucks .....	252	529	1,094		199	422	869	
Motor Homes .....		128	253			94	185	
Other Buses .....	687	992	1,906		514	754	1,428	
Refuse Trucks .....		747	1,459			579	1,115	
School Buses .....	170	263	484		127	199	362	
Short-Haul Combination Trucks .....		1,251	2,224			992	1,771	
Short-Haul Single Unit Trucks .....	216	429	889		168	337	694	
Transit Buses .....	675	896		1,669	504	681		1,241

2. Costs Associated With Changes in Fuel Consumption on Gasoline Engines

We have estimated a decrease in fuel costs, *i.e.*, fuel savings, associated with the final ORVR requirements on gasoline engines. Due to the ORVR systems, evaporative emissions that would otherwise be emitted into the atmosphere will be trapped and

subsequently burned in the engine. We describe the approach taken to estimate these impacts in Chapter 7.2.2 of the RIA. These newly captured evaporative emissions are converted to gallons and then multiplied by AEO 2019 reference case gasoline prices (converted to 2017 dollars) to arrive at the monetized impacts. These impacts are shown in

Table V–18. In the aggregate, we estimate that the ORVR requirements in the final program will result in an annual reduction of approximately 0.3 million (calendar year 2027) to 4.9 million (calendar year 2045) gallons of gasoline, representing roughly 0.1 percent of gasoline consumption from impacted vehicles.

TABLE V-18—MY2027 LIFETIME FUEL COSTS PER GASOLINE VEHICLE ASSOCIATED WITH ORVR REQUIREMENTS, 2017 DOLLARS

	3% Discount rate			7% Discount rate		
	Light HDE	Medium HDE	Heavy HDE	Light HDE	Medium HDE	Heavy HDE
<b>FRM Baseline</b>						
Long-Haul Single Unit Trucks .....	120,876	150,530	192,727	94,841	118,108	151,216
Motor Homes .....	30,329	38,339	48,887	21,905	27,691	35,309
Other Buses .....	273,223	.....	.....	201,982	.....	.....
School Buses .....	69,242	.....	.....	51,188	.....	.....
Short-Haul Single Unit Trucks .....	86,494	109,427	139,754	66,791	84,501	107,918
Transit Buses .....	269,797	.....	.....	199,449	.....	.....
<b>FRM Baseline + Final Program</b>						
Long-Haul Single Unit Trucks .....	120,744	150,349	192,470	94,739	117,969	151,019
Motor Homes .....	30,271	38,260	48,781	21,864	27,635	35,233
Other Buses .....	272,656	.....	.....	201,570	.....	.....
School Buses .....	69,110	.....	.....	51,092	.....	.....
Short-Haul Single Unit Trucks .....	86,397	109,292	139,566	66,717	84,399	107,777
Transit Buses .....	269,245	.....	.....	199,047	.....	.....
<b>Increased Cost of the Final Program</b>						
Long-Haul Single Unit Trucks .....	-132	-181	-257	-102	-139	-197
Motor Homes .....	-58	-79	-106	-41	-56	-75
Other Buses .....	-567	.....	.....	-412	.....	.....
School Buses .....	-132	.....	.....	-96	.....	.....
Short-Haul Single Unit Trucks .....	-97	-135	-187	-74	-102	-141
Transit Buses .....	-552	.....	.....	-402	.....	.....

3. Emission-Related Repair Cost Impacts Associated With the Final Program

The final extended warranty and useful life requirements will have an impact on emission-related repair costs incurred by truck owners. Researchers have noted the relationships among quality, reliability, and warranty for a variety of goods.<sup>444</sup> Wu,<sup>445</sup> for instance, examines how analyzing warranty data can provide “early warnings” on product problems that can then be used for design modifications. Guajardo et al. describe one of the motives for warranties to be “incentives for the seller to improve product quality”; specifically for light-duty vehicles, they find that buyers consider warranties to substitute for product quality, and to complement service quality.<sup>446</sup> Murthy and Jack, for new products, and Saidi-Mehrabad et al. for second-hand

products, consider the role of warranties in improving a buyer’s confidence in quality of the good.<sup>447 448</sup>

On the one hand, we expect owner-incurred emission repair costs to decrease due to the final program because the longer emission warranty requirements will result in more repair costs covered by the OEMs. Further, we expect improved serviceability in an effort by OEMs to decrease the repair costs that they will incur. We also expect that the longer useful life periods in the final standards will result in more durable parts to ensure regulatory compliance over the longer timeframe. On the other hand, we also expect that the more costly emission control systems required by the final program may result in higher repair costs which might increase owner-incurred costs outside the warranty and/or useful life periods.

As discussed in Section V.A.2, we have estimated increased OEM costs associated with increased warranty

liability (*i.e.*, longer warranty periods), and for more durable parts resulting from the longer useful life periods. These costs are accounted for via increased warranty costs and increased research and development (R&D) costs. We also included additional aftertreatment costs in the direct manufacturing costs to address the increased useful life requirements (*e.g.*, larger catalyst volume; see Chapters 2 and 3 of the RIA for detailed discussions). We estimate that the new useful life and warranty provisions will help to reduce emission repair costs during the emission warranty and regulatory useful life periods, and possibly beyond.

In the proposal, to estimate impacts on emission repair costs, we began with an emission repair cost curve derived from an industry white paper.<sup>449</sup> Some commenters took exception to the approach we took, preferring instead that we use what they consider to be a more established repair and maintenance cost estimate from the American Transportation Research

<sup>444</sup> Thomas, M., and S. Rao (1999). “Warranty Economic Decision Models: A Summary and Some Suggested Directions for Future Research.” *Operations Research* 47(6):807–820.

<sup>445</sup> Wu, S (2012). *Warranty Data Analysis: A Review. Quality and Reliability Engineering International* 28: 795–805.

<sup>446</sup> Guajardo, J., M Cohen, and S. Netessine (2016). “Service Competition and Product Quality in the U.S. Automobile Industry.” *Management Science* 62(7):1860–1877. The other rationales are protection for consumers against failures, provision of product quality information to consumers, and a means to distinguish consumers according to their risk preferences.

<sup>447</sup> Murthy, D., and N. Jack (2009). “Warranty and Maintenance,” Chapter 18 in *Handbook of Maintenance Management and Engineering*, Mohamed Ben-Daya et al., editors. London: Springer.

<sup>448</sup> Saidi-Mehrabad, M., R. Noorossana, and M. Shafiee (2010). “Modeling and analysis of effective ways for improving the reliability of second-hand products sold with warranty.” *International Journal of Advanced Manufacturing Technology* 46: 253–265.

<sup>449</sup> See “Mitigating Rising Maintenance & Repair Costs for Class-8 Truck Fleets, Effective Data & Strategies to Leverage Newer Trucks to Reduce M&R Costs,” *Fleet Advantage Whitepaper Series*, 2018.

Institute.<sup>450</sup> After careful consideration of the ATRI data, we derived a cost per mile value for repair and maintenance based on the 10 years of data gathered and presented. We chose to use the ATRI data in place of the data used in the proposal because it constituted 10 years of data from an annually prepared study compared to the one year of data behind the study used in the proposal.

Because the ATRI data represent heavy HD combination vehicles it was necessary for us to scale the ATRI values for applicability to HD vehicles with different sized engines having different emission-control system costs. We have done this in the same way as was discussed earlier for scaling of

warranty cost (see Table V–6). Given that future engines and vehicles will be equipped with new, more costly technology, it is possible that the repair costs for vehicles under the final program will be higher than the repair costs in the baseline. We have included such an increase for the period beyond useful life. This is perhaps conservative because it seems reasonable to assume that the R&D used to improve durability during the useful life period would also improve durability beyond it.

Nonetheless, we also think it is reasonable to include an increase in repair costs, relative to the baseline case, because the period beyond useful life is of marginally less concern to

manufacturers.<sup>451</sup> Lastly, since our warranty and useful life provisions pertain to emissions-related systems and their repair, we adjusted the ATRI values by 10.8 percent to arrive at an emission-related repair cost. The 10.8 percent value was similarly used in the proposal and was derived by EPA using data in the Fleet Advantage Whitepaper. Table V–19 shows how we have scaled the repair and maintenance costs derived from the ATRI study.

Importantly, during the warranty period, there are no emission-related repair costs incurred by owner/operators since those will be covered under warranty.

TABLE V–19—SCALING APPROACH USED IN ESTIMATING BASELINE EMISSION-RELATED REPAIR COSTS PER MILE, 2017 CENTS \*

MOVES regulatory class	Scaling approach	Repair & maintenance			Emission-related repair (10.8% of repair & maintenance)		
		Diesel	Gasoline	CNG	Diesel	Gasoline	CNG
		Light HDE	10.1	7.28	.....	1.09	0.79
Medium HDE	10.3	7.28	.....	1.12	0.79	.....	
Heavy HDE	15.8	7.28	23.2	1.71	0.79	2.52	
Urban bus	9.80	.....	16.2	1.06	.....	1.75	

\*The Base Diesel Heavy HDE DMC would be the \$5,816 value shown in Table V–2; shown is scaling of baseline emission-repair costs per mile although we also scaled emission-repair cost per hour and applied those values for most vocational vehicles; this is detailed in Chapter 7.2.3 of the final RIA.

We present more details in Chapter 7 of the RIA behind the emission-repair cost values we are using, the scaling used and the 10.8 percent emission-related repair adjustment factor and how it was derived. As done for warranty costs, we have used estimated ages for when warranty and useful life are reached, using the required miles, ages and hours along with the estimated miles driven and hours of operation for each specific type of vehicle. This means that warranty and useful life ages

are reached in different years for different vehicles, even if they belong to the same service class and have the same regulatory warranty and useful life periods. For example, we expect warranty and useful life ages to be attained at different points in time by a long-haul combination truck driving over 100,000 miles per year or over 2,000 hours per year and a refuse truck driven around 40,000 miles per year or operating less than 1,000 hours per year. The resultant MY2027 lifetime

emission-related repair costs are shown in Table V–20 for diesel HD vehicles, in Table V–21 for gasoline HD vehicles, and in Table V–22 for CNG HD vehicles. Since these costs occur over time, we present them using both a 3 percent and a 7 percent discount rate. Note that these costs assume that all emission-related repair costs are paid by manufacturers during the warranty period, and beyond the warranty period the emission-related repair costs are incurred by owners/operators.

TABLE V–20—MY2027 LIFETIME EMISSION-RELATED REPAIR COSTS PER DIESEL VEHICLE, 2017 DOLLARS

	3% Discount rate				7% Discount rate			
	Light HDE	Medium HDE	Heavy HDE	Urban bus	Light HDE	Medium HDE	Heavy HDE	Urban bus
<b>FRM Baseline</b>								
Long-Haul Combination Trucks	.....	.....	22,041	.....	.....	.....	16,138	.....
Long-Haul Single Unit Trucks	3,208	2,493	3,060	.....	2,440	1,790	2,109	.....
Motor Homes	.....	613	936	.....	.....	394	602	.....
Other Buses	4,292	3,668	4,719	.....	3,083	2,499	3,074	.....
Refuse Trucks	.....	2,222	3,110	.....	.....	1,506	2,065	.....
School Buses	1,148	1,050	1,604	.....	771	684	1,045	.....
Short-Haul Combination Trucks	.....	6,635	8,088	.....	.....	5,003	5,823	.....
Short-Haul Single Unit Trucks	1,799	1,292	1,973	.....	1,318	876	1,338	.....

<sup>450</sup> “An Analysis of the Operational Costs of Trucking: 2021 Update,” American Transportation Research Institute, November 2021.

<sup>451</sup> This is not meant to suggest that manufacturers no longer care about their products beyond their regulatory useful life, but rather to

reflect the expectation that regulatory pressures—i.e., regulatory compliance during the useful life—tend to focus manufacturer resources.



TABLE V-20—MY2027 LIFETIME EMISSION-RELATED REPAIR COSTS PER DIESEL VEHICLE, 2017 DOLLARS—Continued

	3% Discount rate				7% Discount rate			
	Light HDE	Medium HDE	Heavy HDE	Urban bus	Light HDE	Medium HDE	Heavy HDE	Urban bus
Transit Buses .....	4,242	3,625	.....	3,941	3,047	2,469	.....	2,732
<b>FRM Baseline + Final Program</b>								
Long-Haul Combination Trucks .....	.....	.....	25,070	.....	.....	.....	17,497	.....
Long-Haul Single Unit Trucks .....	2,284	1,531	1,524	.....	1,509	956	906	.....
Motor Homes .....	.....	480	728	.....	.....	272	415	.....
Other Buses .....	4,090	3,261	3,454	.....	2,598	1,978	1,979	.....
Refuse Trucks .....	.....	1,408	2,038	.....	.....	819	1,180	.....
School Buses .....	667	772	1,174	.....	378	439	673	.....
Short-Haul Combination Trucks .....	.....	7,029	6,436	.....	.....	4,960	4,225	.....
Short-Haul Single Unit Trucks .....	764	721	1,115	.....	451	421	655	.....
Transit Buses .....	4,042	3,224	.....	2,394	2,567	1,955	.....	1,370
<b>Increased Cost of the Final Program</b>								
Long-Haul Combination Trucks .....	.....	.....	3,028	.....	.....	.....	1,359	.....
Long-Haul Single Unit Trucks .....	-924	-962	-1,536	.....	-931	-834	-1,203	.....
Motor Homes .....	.....	-132	-207	.....	.....	-122	-187	.....
Other Buses .....	-203	-406	-1,265	.....	-486	-520	-1,095	.....
Refuse Trucks .....	.....	-814	-1,072	.....	.....	-687	-885	.....
School Buses .....	-481	-278	-430	.....	-393	-245	-372	.....
Short-Haul Combination Trucks .....	.....	394	-1,651	.....	.....	-43	-1,598	.....
Short-Haul Single Unit Trucks .....	-1,035	-570	-857	.....	-867	-455	-684	.....
Transit Buses .....	-200	-402	.....	-1,547	-480	-514	.....	-1,362

TABLE V-21—MY2027 LIFETIME EMISSION-RELATED REPAIR COSTS PER GASOLINE VEHICLE, 2017 DOLLARS

	3% Discount rate			7% Discount rate		
	Light HDE	Medium HDE	Heavy HDE	Light HDE	Medium HDE	Heavy HDE
<b>FRM Baseline</b>						
Long-Haul Single Unit Trucks .....	2,324	2,324	2,324	1,768	1,768	1,768
Motor Homes .....	431	431	431	278	278	278
Other Buses .....	3,111	.....	.....	2,234	.....	.....
School Buses .....	832	.....	.....	559	.....	.....
Short-Haul Single Unit Trucks .....	1,304	1,304	1,304	955	955	955
Transit Buses .....	3,074	.....	.....	2,208	.....	.....
<b>FRM Baseline + Final Program</b>						
Long-Haul Single Unit Trucks .....	1,831	1,831	1,831	1,271	1,271	1,271
Motor Homes .....	275	275	275	156	156	156
Other Buses .....	2,898	.....	.....	1,917	.....	.....
School Buses .....	442	.....	.....	252	.....	.....
Short-Haul Single Unit Trucks .....	764	764	764	483	483	483
Transit Buses .....	2,865	.....	.....	1,895	.....	.....
<b>Increased Cost of the Final Program</b>						
Long-Haul Single Unit Trucks .....	-493	-493	-493	-497	-497	-497
Motor Homes .....	-156	-156	-156	-122	-122	-122
Other Buses .....	-212	.....	.....	-317	.....	.....
School Buses .....	-390	.....	.....	-306	.....	.....
Short-Haul Single Unit Trucks .....	-540	-540	-540	-471	-471	-471
Transit Buses .....	-210	.....	.....	-313	.....	.....

TABLE V-22—MY2027 LIFETIME EMISSION-RELATED REPAIR COSTS PER CNG VEHICLE, 2017 DOLLARS

	3% Discount rate		7% Discount rate	
	Heavy HDE	Urban bus	Heavy HDE	Urban bus
<b>FRM Baseline</b>				
Long-Haul Single Unit Trucks .....	4,517	.....	3,113	.....
Other Buses .....	6,966	.....	4,537	.....
Refuse Trucks .....	4,590	.....	3,048	.....
School Buses .....	2,368	.....	1,542	.....
Short-Haul Combination Trucks .....	11,938	.....	8,595	.....
Short-Haul Single Unit Trucks .....	2,912	.....	1,975	.....
Transit Buses .....	.....	6,532	.....	4,529
<b>FRM Baseline + Final Program</b>				
Long-Haul Single Unit Trucks .....	1,720	.....	1,029	.....
Other Buses .....	3,807	.....	2,194	.....
Refuse Trucks .....	2,260	.....	1,317	.....
School Buses .....	1,294	.....	746	.....
Short-Haul Combination Trucks .....	7,723	.....	5,143	.....
Short-Haul Single Unit Trucks .....	1,248	.....	737	.....
Transit Buses .....	.....	2,822	.....	1,626
<b>Increased Cost of the Final Program</b>				
Long-Haul Single Unit Trucks .....	-2,797	.....	-2,084	.....
Other Buses .....	-3,158	.....	-2,344	.....
Refuse Trucks .....	-2,330	.....	-1,732	.....
School Buses .....	-1,074	.....	-797	.....
Short-Haul Combination Trucks .....	-4,215	.....	-3,452	.....
Short-Haul Single Unit Trucks .....	-1,664	.....	-1,238	.....
Transit Buses .....	.....	-3,710	.....	-2,903

C. Program Costs

Using the cost elements outlined in Sections V.A and V.B, we have estimated the costs associated with the

final program. Costs are presented in more detail in Chapter 7 of the RIA. As noted earlier, costs are presented in 2017 dollars in undiscounted annual values along with present values (PV)

and equivalent annualized values (EAV) at both 3 and 7 percent discount rates with values discounted to the 2027 calendar year.

TABLE V-23—TOTAL TECHNOLOGY & OPERATING COST IMPACTS OF THE FINAL PROGRAM RELATIVE TO THE BASELINE CASE, ALL REGULATORY CLASSES AND ALL FUELS, BILLIONS OF 2017 DOLLARS <sup>a</sup>

Calendar year	Direct tech cost	Indirect warranty cost	Indirect R&D cost	Other indirect cost	Indirect profit	Total tech cost	Emission repair cost	Urea cost	Fuel cost	Total operating cost	Program cost
2027 .....	1.1	2.1	0.21	0.34	0.058	3.8	0.00	0.06	-0.0004	0.057	3.9
2028 .....	1.1	2.1	0.20	0.32	0.055	3.7	-0.05	0.12	-0.0008	0.07	3.8
2029 .....	1.0	2.1	0.19	0.31	0.053	3.7	-0.30	0.18	-0.0013	-0.12	3.6
2030 .....	1.0	2.1	0.051	0.30	0.052	3.5	-0.43	0.25	-0.0017	-0.19	3.4
2031 .....	1.0	2.2	0.050	0.30	0.051	3.6	-0.50	0.33	-0.0022	-0.17	3.4
2032 .....	0.99	2.2	0.049	0.29	0.050	3.6	-0.57	0.41	-0.0027	-0.16	3.4
2033 .....	0.98	2.2	0.049	0.29	0.050	3.6	-0.61	0.47	-0.0034	-0.14	3.5
2034 .....	0.98	2.3	0.049	0.29	0.049	3.6	-0.64	0.53	-0.0041	-0.11	3.5
2035 .....	0.96	2.3	0.048	0.28	0.049	3.7	-0.66	0.58	-0.0048	-0.08	3.6
2036 .....	0.95	2.3	0.048	0.28	0.048	3.7	-0.66	0.63	-0.0054	-0.04	3.6
2037 .....	0.95	2.4	0.048	0.28	0.048	3.7	-0.60	0.68	-0.0060	0.07	3.8
2038 .....	0.95	2.4	0.048	0.28	0.048	3.7	-0.54	0.72	-0.0066	0.17	3.9
2039 .....	0.95	2.5	0.047	0.28	0.048	3.8	-0.49	0.76	-0.0072	0.27	4.0
2040 .....	0.95	2.5	0.047	0.28	0.048	3.8	-0.45	0.80	-0.0078	0.34	4.2
2041 .....	0.95	2.5	0.047	0.28	0.048	3.9	-0.41	0.84	-0.0083	0.41	4.3
2042 .....	0.95	2.6	0.047	0.28	0.048	3.9	-0.39	0.87	-0.0088	0.47	4.4
2043 .....	0.95	2.6	0.047	0.28	0.048	3.9	-0.37	0.91	-0.0093	0.53	4.5
2044 .....	0.95	2.7	0.048	0.28	0.048	4.0	-0.35	0.94	-0.0097	0.57	4.6
2045 .....	0.95	2.7	0.048	0.28	0.048	4.1	-0.34	0.97	-0.010	0.62	4.7
PV, 3% .....	14	33	1.1	4.2	0.72	53	-6.2	7.7	-0.069	1.4	55
PV, 7% .....	10	24	0.90	3.0	0.52	38	-4.3	4.9	-0.043	0.60	39
EAV, 3% .....	1.0	2.3	0.078	0.29	0.050	3.7	-0.43	0.54	-0.0048	0.099	3.8

TABLE V-23—TOTAL TECHNOLOGY & OPERATING COST IMPACTS OF THE FINAL PROGRAM RELATIVE TO THE BASELINE CASE, ALL REGULATORY CLASSES AND ALL FUELS, BILLIONS OF 2017 DOLLARS <sup>a</sup>—Continued

Calendar year	Direct tech cost	Indirect warranty cost	Indirect R&D cost	Other indirect cost	Indirect profit	Total tech cost	Emission repair cost	Urea cost	Fuel cost	Total operating cost	Program cost
EAV, 7% .....	1.0	2.3	0.087	0.29	0.051	3.7	-0.42	0.48	-0.0042	0.058	3.8

<sup>a</sup> Values show 2 significant digits; negative cost values denote savings; calendar year values are undiscounted, present values are discounted to 2027; Program Cost is the sum of Total Tech Cost and Total Operating Cost. Note also that the Information Collection Request costs addressed in Section XII would fall within the “Other” indirect costs shown here.

**VI. Estimated Emissions Reductions From the Final Program**

The final program, which is described in detail in Sections III and IV, is expected to reduce emissions from highway heavy-duty engines in several ways. We project the final emission standards for heavy-duty CI engines will reduce tailpipe emissions of NO<sub>x</sub>; the combination of the final low-load test cycle and off-cycle test procedure for CI engines will help to ensure that the reductions in tailpipe emissions are achieved in-use, not only under high-speed, on-highway conditions, but also under low-load and idle conditions. We also project reduced tailpipe emissions of NO<sub>x</sub>, CO, PM, VOCs, and associated air toxics from the final emission standards for heavy-duty SI engines, particularly under cold-start and high-load operating conditions. The longer emission warranty and regulatory useful life requirements for heavy-duty CI and SI engines in the final rule will help maintain the expected emission reductions for all pollutants, including primary exhaust PM<sub>2.5</sub>, throughout the useful life of the engine. The onboard refueling vapor recovery requirements for heavy-duty SI engines in the final rule will reduce VOCs and associated air toxics. See RIA Chapter 5.3 for details on projected emission reductions of each pollutant.

Section VI.A provides an overview of the methods used to estimate emission

reductions from our final program. All the projected emission reductions from the final program are outlined in Section VI.B, with more details provided in the RIA Chapter 5. Section VI.C presents projected emission reductions from the final program by engine operations and processes (e.g., medium-to-high load or low-load engine operations).

*A. Emission Inventory Methodology*

To estimate the emission reductions from the final program, we used the current public version of EPA’s Motor Vehicle Emission Simulator (MOVES) model, MOVES3. MOVES3 includes all the model updates previously made for the version of the MOVES model used for the NPRM analysis (“MOVES CTI NPRM”), as well as other more recent updates. Detailed descriptions of the underlying data and analyses that informed the model updates are discussed in Chapter 5.2 of the RIA and documented in peer-reviewed technical reports referenced in the RIA. Inputs developed to model the national emission inventories for the final program are also discussed in Chapter 5.2.2 of the RIA.

*B. Estimated Emission Reductions From the Final Program*

As discussed in Sections III and IV, the final program includes new, more stringent numeric emission standards, as well as longer regulatory useful life

and emissions warranty periods compared to today’s standards. Our estimates of the emission impacts of the final program in calendar years 2030, 2040, and 2045 are presented in Table VI-1. As shown in Table VI-1, we estimate that the final program will reduce NO<sub>x</sub> emissions from highway heavy-duty vehicles by 48 percent nationwide in 2045. We also estimate an eight percent reduction in primary exhaust PM<sub>2.5</sub> from highway heavy-duty vehicles. VOC emissions from heavy-duty vehicles will be 23 percent lower. Emissions of CO from heavy-duty vehicles are estimated to decrease by 18 percent. Reductions in heavy-duty vehicle emissions of other pollutants, including air toxics, range from an estimated reduction of about 28 percent for benzene to about seven percent change in acetaldehyde. RIA Chapter 5.5.2 includes additional details on the emission reductions by vehicle fuel type; Chapter 5.5.4 provides our estimates of criteria pollutant emissions reductions for calendar years 2027 through 2045.

As the final program is implemented, emission reductions are expected to increase over time as the fleet turns over to new, compliant engines. We estimate no change in CO<sub>2</sub> emissions from the final program, based on data in our feasibility and cost analyses of the final program (see Section III for more discussion).<sup>452</sup>

TABLE VI-1—ANNUAL EMISSION REDUCTIONS FROM HEAVY-DUTY VEHICLES IN CALENDAR YEARS (CY) 2030, 2040, AND 2045—EMISSIONS WITH FINAL PROGRAM IN PLACE RELATIVE TO THE HEAVY-DUTY VEHICLE EMISSIONS BASELINE

Pollutant	CY2030		CY2040		CY2045	
	US short tons	% reduction	US short tons	% reduction	US short tons	% reduction
NO <sub>x</sub> .....	139,677	14	398,864	44	453,239	48
VOC .....	5,018	5	17,139	20	20,758	23
Primary Exhaust PM <sub>2.5</sub> .....	115	1	491	7	566	8
CO .....	43,978	3	208,935	16	260,750	18
Acetaldehyde .....	36	2	124	6	145	7
Benzene .....	40	4	177	23	221	28
Formaldehyde .....	29	1	112	7	134	8

<sup>452</sup> This estimate includes the assumption that vehicle sales will not change in response to the

final rule. See Section X for further discussion on vehicle sales impacts of this final rule.

TABLE VI-1—ANNUAL EMISSION REDUCTIONS FROM HEAVY-DUTY VEHICLES IN CALENDAR YEARS (CY) 2030, 2040, AND 2045—EMISSIONS WITH FINAL PROGRAM IN PLACE RELATIVE TO THE HEAVY-DUTY VEHICLE EMISSIONS BASELINE—Continued

Pollutant	CY2030		CY2040		CY2045	
	US short tons	% reduction	US short tons	% reduction	US short tons	% reduction
Naphthalene .....	2	1	7	13	9	16

*C. Estimated Emission Reductions by Engine Operations and Processes*

Looking more closely at the NO<sub>x</sub> emission inventory from highway heavy-duty vehicles, our analysis shows that the final standards will reduce emissions across several engine operations and processes, with the greatest reductions attributable to medium-to-high load engine operations, low-load engine operations, and age effects (Table VI-2). Emission reductions attributable to medium-to-high load engine operations are based on changes in the new numeric emissions standards compared to existing standards and corresponding test procedures, as described in preamble Section III. Emission reductions attributable to the age effects category are based on longer useful life and warranty periods in the final rule, which are described in preamble Section IV.

Table 5-13 in Chapter 5.2.2 of the RIA shows that tampering and mal-maintenance significantly increases emissions from current heavy heavy-duty engines (e.g., we estimate a 500 percent increase in NO<sub>x</sub> emissions for heavy heavy-duty vehicles due to NO<sub>x</sub> aftertreatment malfunction). Absent the

final rule, these substantial increases in emissions from tampering and mal-maintenance could potentially have large impact on the HD NO<sub>x</sub> inventory. However, the longer regulatory useful life and emission-related warranty requirements in the final rule will ensure that more stringent standards are met for a longer period of time while the engines are in use. Specifically, we estimate 18 percent fewer NO<sub>x</sub> emissions in 2045 due to the longer useful life and warranty periods reducing the likelihood of tampering and mal-maintenance after the current useful life periods of heavy-duty CI engines.<sup>453 454</sup> We note that these estimates of emissions impacts from tampering and mal-maintenance of heavy-duty engines reflect currently available data and may not fully reflect the extent of emissions impacts from tampering or mal-maintenance; thus, additional data on the emissions impacts of heavy-duty tampering and mal-maintenance may show that there would be additional emissions reductions from the final rule.

Further, due to insufficient data, we are currently unable to quantify the impacts of other provisions to improve maintenance and serviceability of

emission controls systems (e.g., updated maintenance intervals, requiring manufacturers to provide more information on how to diagnose and repair emission control systems, as described in preamble Section IV). We expect the final provisions to improve maintenance and serviceability will reduce incentives to tamper with the emission control systems on MY 2027 and later engines, which would avoid large increases in emissions that would impact the reductions projected from the final rule. For example, we estimate a greater than 3000 percent increase in NO<sub>x</sub> emissions for heavy heavy-duty vehicles due to malfunction of the NO<sub>x</sub> emissions aftertreatment on a MY 2027 and later heavy heavy-duty vehicle. As such, the maintenance and serviceability provisions combined with the longer useful life and warranty periods will provide a comprehensive approach to ensure that the new, much more stringent emissions standards are met during in use operations.

Table VI-2 compares NO<sub>x</sub> emissions in 2045 from different engine operations and processes with and without the final standards. A graphical comparison of NO<sub>x</sub> emissions by process is included in RIA Chapter 5.5.3.

TABLE VI-2—HEAVY-DUTY NO<sub>x</sub> EMISSION REDUCTIONS BY PROCESS IN CY2045 [US tons]

Engine operation or process	Emission inventory contribution without final program (%)	Tons reduced	Percent reduction from baseline	Emission inventory contribution with final program (%)
Medium- to High-Load .....	36	217,708	64	24
Low-Load .....	30	177,967	63	21
Aging .....	22	35,750	18	34
Extended Idle & APU .....	2	11,692	63	1
Starts .....	5	10,122	23	7
Historical Fleet (MY 2010 to 2026) .....	6	0	0	12

**VII. Air Quality Impacts of the Final Rule**

As discussed in Section VI, we project the standards in the final rule will result

in meaningful reductions in emissions of NO<sub>x</sub>, VOC, CO and PM<sub>2.5</sub>. When feasible, we conduct full-scale photochemical air quality modeling to

accurately project levels of criteria and air toxic pollutants, because the atmospheric chemistry related to ambient concentrations of PM<sub>2.5</sub>, ozone,

<sup>453</sup> See Chapter 5.2.2 of the RIA for a discussion of how we calculate the emission rates due to the final useful life and warranty periods for Light, Medium, and Heavy heavy-duty engines.

<sup>454</sup> Although we anticipate emission benefits from the lengthened warranty and useful life periods from gasoline and NG-fueled vehicles, they were

not included in the analysis done for the final rule (see RIA Chapter 5.2 for details).

and air toxics is very complex. Air quality modeling was performed for the proposed rule and demonstrated improvements in concentrations of air pollutants. Given the similar structure of the proposed and final programs, the geographic distribution of emissions reductions and modeled improvements in air quality are consistent and demonstrate that the final rule will lead to substantial improvements in air quality.<sup>455</sup>

Specifically, we expect this rule will decrease ambient concentrations of air pollutants, including significant improvements in ozone concentrations in 2045 as demonstrated in the air quality modeling analysis. We also expect reductions in ambient PM<sub>2.5</sub>, NO<sub>2</sub> and CO due to this rule. Although the spatial resolution of the air quality modeling is not sufficient to quantify it, this rule’s emission reductions will also reduce air pollution in close proximity to major roadways, where concentrations of many air pollutants are elevated and where people of color and people with low income are disproportionately exposed.

The emission reductions provided by the final standards will be important in

helping areas attain the NAAQS and prevent future nonattainment. In addition, the final standards are expected to result in improvements in nitrogen deposition and visibility. Additional information and maps showing expected changes in ambient concentrations of air pollutants in 2045 are included in the proposal, Chapter 6 of the RIA and in the Air Quality Modeling Technical Support Document from the proposed rule.<sup>456 457</sup>

The proposed rule air quality modeling analysis consisted of a base case, reference scenario, and control scenario. The “base” case represents 2016 air quality. The “reference” scenario represents projected 2045 air quality without the proposed rule and the “control” scenario represents projected 2045 emissions with the proposed rule. Air quality modeling was done for the future year 2045 when the program will be fully implemented and when most of the regulated fleet will have turned over.

*A. Ozone*

The scenario modeled for the proposed rule reduced 8-hour ozone design values significantly in 2045.

Ozone design values decreased by more than 2 ppb in over 150 counties, and over 200 additional modeled counties are projected to have decreases in ozone design values of between 1 and 2 ppb in 2045. Our modeling projections indicate that some counties will have design values above the level of the 2015 NAAQS in 2045, and the rule will help those counties, as well as other counties, in reducing ozone concentrations. Table VII–1 shows the average projected change in 2045 8-hour ozone design values due to the modeled scenario. Counties within 10 percent of the level of the NAAQS are intended to reflect counties that, although not violating the standard, would also be affected by changes in ambient levels of ozone as they work to ensure long-term attainment or maintenance of the ozone NAAQS. The projected changes in design values, summarized in Table VII–1, indicate in different ways the overall improvement in ozone air quality due to emission reductions from the modeled scenario.

TABLE VII–1—AVERAGE CHANGE IN PROJECTED 8-HOUR OZONE DESIGN VALUES IN 2045 DUE TO THE RULE

Projected design value category	Number of counties	2045 Population <sup>a</sup>	Average change in 2045 design value (ppb)	Population-weighted average change in design value (ppb)
all modeled counties .....	457	246,949,949	– 1.87	– 2.23
counties with 2016 base year design values above the level of the 2015 8-hour ozone standard .....	118	125,319,158	– 2.12	– 2.43
counties with 2016 base year design values within 10% of the 2015 8-hour ozone standard .....	245	93,417,097	– 1.83	– 2.10
counties with 2045 reference design values above the level of the 2015 8-hour ozone standard .....	15	37,758,488	– 2.26	– 3.03
counties with 2045 reference design values within 10% of the 2015 8-hour ozone standard ..	56	39,302,665	– 1.78	– 2.02
counties with 2045 control design values above the level of the 2015 8-hour ozone standard ..	10	27,930,138	– 2.36	– 3.34
counties with 2045 control design values within 10% of the 2015 8-hour ozone standard .....	42	31,395,617	– 1.69	– 1.77

<sup>a</sup>Population numbers based on Woods & Poole data. Woods & Poole Economics, Inc. (2015). Complete Demographic Database. Washington, DC. <http://www.woodsandpoole.com/index.php>.

*B. Particulate Matter*

The scenario modeled for the proposed rule reduced 24-hour and annual PM<sub>2.5</sub> design values in 2045. Annual PM<sub>2.5</sub> design values in the majority of modeled counties decreased by between 0.01 and 0.05 µg/m<sup>3</sup> and by greater than 0.05 µg/m<sup>3</sup> in over 75 additional counties. 24-hour PM<sub>2.5</sub> design values decreased by between 0.15 and 0.5 µg/m<sup>3</sup> in over 150 counties and by greater than 0.5 µg/m<sup>3</sup> in 5 additional counties. Our modeling projections indicate that some counties

will have design values above the level of the 2012 PM<sub>2.5</sub> NAAQS in 2045 and the rule will help those counties, as well as other counties, in reducing PM<sub>2.5</sub> concentrations. Table VII–2 and Table VII–3 present the average projected changes in 2045 annual and 24-hour PM<sub>2.5</sub> design values. Counties within 10 percent of the level of the NAAQS are intended to reflect counties that, although not violating the standards, would also be affected by changes in ambient levels of PM<sub>2.5</sub> as they work to ensure long-term attainment or

maintenance of the annual and/or 24-hour PM<sub>2.5</sub> NAAQS. The projected changes in PM<sub>2.5</sub> design values, summarized in Table VII–2 and Table VII–3, indicate in different ways the overall improvement in PM<sub>2.5</sub> air quality due to the emission reductions resulting from the modeled scenario. We expect this rule’s reductions in directly emitted PM<sub>2.5</sub> will also contribute to reductions in PM<sub>2.5</sub> concentrations near roadways, although our air quality modeling is not of sufficient resolution to capture that impact.

<sup>455</sup> Additional detail on the air quality modeling inventory used in the proposed rule, along with the final rule emission reductions, can be found in Chapter 5 of the RIA.

<sup>456</sup> USEPA (2021) Technical Support Document: Air Quality Modeling for the HD 2027 Proposal. EPA–HQ–OAR–2019–0055. October 2021.

<sup>457</sup> Section VII of the proposed rule preamble, 87 FR 17414 (March 28, 2022).

TABLE VII-2—AVERAGE CHANGE IN PROJECTED ANNUAL PM<sub>2.5</sub> DESIGN VALUES IN 2045 DUE TO THE RULE

Projected design value category	Number of counties	2045 Population <sup>a</sup>	Average change in 2045 design value (ug/m <sup>3</sup> )	Population-weighted average change in design value (ug/m <sup>3</sup> )
all modeled counties .....	568	273,604,437	-0.04	-0.04
counties with 2016 base year design values above the level of the 2012 annual PM <sub>2.5</sub> standard .....	17	26,726,354	-0.09	-0.05
counties with 2016 base year design values within 10% of the 2012 annual PM <sub>2.5</sub> standard ..	5	4,009,527	-0.06	-0.06
counties with 2045 reference design values above the level of the 2012 annual PM <sub>2.5</sub> standard .....	12	25,015,974	-0.10	-0.05
counties with 2045 reference design values within 10% of the 2012 annual PM <sub>2.5</sub> standard ..	6	1,721,445	-0.06	-0.06
counties with 2045 control design values above the level of the 2012 annual PM <sub>2.5</sub> standard ..	10	23,320,070	-0.10	-0.05
counties with 2045 control design values within 10% of the 2012 annual PM <sub>2.5</sub> standard .....	8	3,417,349	-0.08	-0.09

<sup>a</sup> Population numbers based on Woods & Poole data. Woods & Poole Economics, Inc. (2015). Complete Demographic Database. Washington, DC. <http://www.woodsandpoole.com/index.php>.

TABLE VII-3—AVERAGE CHANGE IN PROJECTED 24-HOUR PM<sub>2.5</sub> DESIGN VALUES IN 2045 DUE TO THE RULE

Projected design value category	Number of counties	2045 Population <sup>a</sup>	Average change in 2045 design value (ug/m <sup>3</sup> )	Population-weighted average change in design value (ug/m <sup>3</sup> )
all modeled counties .....	568	272,852,777	-0.12	-0.17
counties with 2016 base year design values above the level of the 2006 daily PM <sub>2.5</sub> standard .....	33	28,394,253	-0.40	-0.67
counties with 2016 base year design values within 10% of the 2006 daily PM <sub>2.5</sub> standard .....	15	13,937,416	-0.18	-0.27
counties with 2045 reference design values above the level of the 2006 daily PM <sub>2.5</sub> standard .....	29	14,447,443	-0.38	-0.55
counties with 2045 reference design values within 10% of the 2006 daily PM <sub>2.5</sub> standard .....	12	22,900,297	-0.30	-0.59
counties with 2045 control design values above the level of the 2006 daily PM <sub>2.5</sub> standard ..	29	14,447,443	-0.38	-0.55
counties with 2045 control design values within 10% of the 2006 daily PM <sub>2.5</sub> standard .....	10	19,766,216	-0.26	-0.60

<sup>a</sup> Population numbers based on Woods & Poole data. Woods & Poole Economics, Inc. (2015). Complete Demographic Database. Washington, DC. <http://www.woodsandpoole.com/index.php>.

### C. Nitrogen Dioxide

The scenario modeled for the proposed rule decreased annual NO<sub>2</sub> concentrations in most urban areas and along major roadways by more than 0.3 ppb and decreased annual NO<sub>2</sub> concentrations by between 0.01 and 0.1 ppb across much of the rest of the country in 2045. The emissions reductions in the modeled scenario will also likely decrease 1-hour NO<sub>2</sub> concentrations and help any potential nonattainment areas attain and maintenance areas maintain the NO<sub>2</sub> standard.<sup>458</sup> We expect this rule will also contribute to reductions in NO<sub>2</sub> concentrations near roadways, although our air quality modeling is not of sufficient resolution to capture that impact. Section 6.4.4 of the RIA contains more detail on the impacts of the rule on NO<sub>2</sub> concentrations.

### D. Carbon Monoxide

The scenario modeled for the proposed rule decreased annual CO concentrations by more than 0.5 ppb in many urban areas and decreased annual CO concentrations by between 0.02 and 0.5 ppb across much of the rest of the country in 2045. The emissions reductions in the modeled scenario will

<sup>458</sup> As noted in Section II, there are currently no nonattainment areas for the NO<sub>2</sub> NAAQS.

also likely decrease 1-hour and 8-hour CO concentrations and help any potential nonattainment areas attain and maintenance areas maintain the CO standard.<sup>459</sup> Section 6.4.5 of the RIA contains more detail on the impacts of the rule on CO concentrations.

### E. Air Toxics

In general, the scenario modeled for the proposed rule had relatively little impact on national average ambient concentrations of the modeled air toxics in 2045. The modeled scenario had smaller impacts on air toxic pollutants dominated by primary emissions (or a decay product of a directly emitted pollutant), and relatively larger impacts on air toxics that primarily result from photochemical transformation, in this case due to the projected large reductions in NO<sub>x</sub> emissions. Specifically, in 2045, our modeling projects that ambient benzene and naphthalene concentrations will decrease by less than 0.001 ug/m<sup>3</sup> across the country. Acetaldehyde concentrations will increase slightly across most of the country, while formaldehyde will generally have small decreases in most areas and some small increases in urban areas. Section 6.4.6 of the RIA contains more detail on the

<sup>459</sup> As noted in Section II, there are currently no nonattainment areas for the CO NAAQS.

impacts of the modeled scenario on air toxics concentrations.

### F. Visibility

Air quality modeling was used to project visibility conditions in 145 Mandatory Class I Federal areas across the United States. The results show that the modeled scenario improved visibility in these areas.<sup>460</sup> The average visibility at all modeled Mandatory Class I Federal areas on the 20 percent most impaired days is projected to improve by 0.04 deciviews, or 0.37 percent, in 2045 due to the rule. Section 6.4.7 of the RIA contains more detail on the visibility portion of the air quality modeling.

### G. Nitrogen Deposition

The scenario modeled for the proposed rule projected substantial decreases in nitrogen deposition in 2045. The modeled scenario resulted in annual decreases of greater than 4 percent in some areas and greater than

<sup>460</sup> The level of visibility impairment in an area is based on the light-extinction coefficient and a unitless visibility index, called a "deciview", which is used in the valuation of visibility. The deciview metric provides a scale for perceived visual changes over the entire range of conditions, from clear to hazy. Under many scenic conditions, the average person can generally perceive a change of one deciview. The higher the deciview value, the worse the visibility. Thus, an improvement in visibility is a decrease in deciview value.

1 percent over much of the rest of the country. For maps of deposition impacts, and additional information on these impacts, see Section 6.4.8 of the RIA.

#### H. Environmental Justice

EPA's 2016 "Technical Guidance for Assessing Environmental Justice in Regulatory Analysis" provides recommendations on conducting the highest quality analysis feasible, recognizing that data limitations, time and resource constraints, and analytic challenges will vary by media and regulatory context.<sup>461</sup> When assessing the potential for disproportionately high and adverse health or environmental impacts of regulatory actions on people of color, low-income populations, Tribes, and/or indigenous peoples, the EPA strives to answer three broad questions: (1) Is there evidence of potential environmental justice (EJ) concerns in the baseline (the state of the world absent the regulatory action)? Assessing the baseline will allow the EPA to determine whether pre-existing disparities are associated with the pollutant(s) under consideration (e.g., if the effects of the pollutant(s) are more concentrated in some population groups). (2) Is there evidence of potential EJ concerns for the regulatory option(s) under consideration? Specifically, how are the pollutant(s) and its effects distributed for the regulatory options under consideration? And, (3) do the regulatory option(s) under consideration exacerbate or mitigate EJ concerns relative to the baseline? It is not always possible to quantitatively assess these questions.

EPA's 2016 Technical Guidance does not prescribe or recommend a specific approach or methodology for conducting an environmental justice analysis, though a key consideration is consistency with the assumptions underlying other parts of the regulatory analysis when evaluating the baseline and regulatory options. Where applicable and practicable, the Agency endeavors to conduct such an analysis.<sup>462</sup> EPA is committed to conducting environmental justice analysis for rulemakings based on a framework similar to what is outlined in

EPA's Technical Guidance, in addition to investigating ways to further weave environmental justice into the fabric of the rulemaking process.

There is evidence that communities with EJ concerns are disproportionately impacted by the emissions sources controlled in this final rule.<sup>463</sup> Numerous studies have found that environmental hazards such as air pollution are more prevalent in areas where people of color and low-income populations represent a higher fraction of the population compared with the general population.<sup>464 465 466</sup> Consistent with this evidence, a recent study found that most anthropogenic sources of PM<sub>2.5</sub>, including industrial sources and light- and heavy-duty vehicle sources, disproportionately affect people of color.<sup>467</sup> In addition, compared to non-Hispanic Whites, some other racial groups experience greater levels of health problems during some life stages. For example, in 2018–2020, about 12 percent of non-Hispanic Black; 9 percent of non-Hispanic American Indian/Alaska Native; and 7 percent of Hispanic children were estimated to currently have asthma, compared with 6 percent of non-Hispanic White children.<sup>468</sup> Nationally, on average, non-Hispanic Black and Non-Hispanic American Indian or Alaska Native people also have lower than average life expectancy based on 2019 data, the latest year for which CDC estimates are available.<sup>469</sup>

In addition, as discussed in Section II.B.7 of this document, concentrations of many air pollutants are elevated near high-traffic roadways, and populations

who live, work, or go to school near high-traffic roadways experience higher rates of numerous adverse health effects, compared to populations far away from major roads.

EPA's analysis of environmental justice includes an examination of the populations living in close proximity to truck routes and to major roads more generally. This analysis, described in Section VII.H.1 of this document, finds that there is substantial evidence that people who live or attend school near major roadways are more likely to be people of color, Hispanic ethnicity, and/or low socioeconomic status. This final rule will reduce emissions that contribute to NO<sub>2</sub> and other near-roadway pollution, improving air quality for the 72 million people who live near major truck routes and are already overburdened by air pollution from diesel emissions.

Heavy-duty vehicles also contribute to regional concentrations of ozone and PM<sub>2.5</sub>. As described in Section VII.H.2 of this document, EPA used the air quality modeling data described in this Section VII to conduct a demographic analysis of human exposure to future air quality in scenarios with and without the rule in place. Although the spatial resolution of the air quality modeling is not sufficient to capture very local heterogeneity of human exposures, particularly the pollution concentration gradients near roads, the analysis does allow estimates of demographic trends at a national scale. The analysis indicates that the largest predicted improvements in both ozone and PM<sub>2.5</sub> are estimated to occur in areas with the worst baseline air quality, and that a larger number of people of color are projected to reside in these areas.

#### 1. Demographic Analysis of the Near-Road Population

We conducted an analysis of the populations living in close proximity to truck freight routes as identified in USDOT's FAF4.<sup>470</sup> FAF4 is a model from the USDOT's Bureau of Transportation Statistics (BTS) and Federal Highway Administration (FHWA), which provides data associated with freight movement in the United States.<sup>471</sup> Relative to the rest of

<sup>461</sup> "Technical Guidance for Assessing Environmental Justice in Regulatory Analysis." *Epa.gov*, Environmental Protection Agency, [https://www.epa.gov/sites/production/files/2016-06/documents/ejtg\\_5\\_6\\_16\\_v5.1.pdf](https://www.epa.gov/sites/production/files/2016-06/documents/ejtg_5_6_16_v5.1.pdf). (June 2016).

<sup>462</sup> As described in this section, EPA evaluated environmental justice for this rule as recommended by the EPA 2016 Technical Guidance. However, it is EPA's assessment of the relevant statutory factors in CAA section 202(a)(3)(A) that justify the final emission standards. See section I.D. for further discussion of the statutory authority for this rule.

<sup>463</sup> Mohai, P.; Pellow, D.; Roberts Timmons, J. (2009) Environmental justice. *Annual Reviews* 34: 405–430. <https://doi.org/10.1146/annurev-environ-082508-094348>.

<sup>464</sup> Rowangould, G.M. (2013) A census of the near-roadway population: public health and environmental justice considerations. *Trans Res D* 25: 59–67. <http://dx.doi.org/10.1016/j.trd.2013.08.003>.

<sup>465</sup> Marshall, J.D., Swor, K.R.; Nguyen, N.P. (2014) Prioritizing environmental justice and equality: diesel emissions in Southern California. *Environ Sci Technol* 48: 4063–4068. <https://doi.org/10.1021/es405167f>.

<sup>466</sup> Marshall, J.D. (2008) Environmental inequality: air pollution exposures in California's South Coast Air Basin. *Atmos Environ* 21: 5499–5503. <https://doi.org/10.1016/j.atmosenv.2008.02.005>.

<sup>467</sup> C.W. Tessum, D.A. Paolella, S.E. Chambliss, J.S. Apte, J.D. Hill, J.D. Marshall, PM<sub>2.5</sub> pollutants disproportionately and systemically affect people of color in the United States. *Sci. Adv.* 7, eabf4491 (2021).

<sup>468</sup> [http://www.cdc.gov/asthma/most\\_recent\\_data.htm](http://www.cdc.gov/asthma/most_recent_data.htm).

<sup>469</sup> Arias, E. Xu, J. (2022) United States Life Tables, 2019. *National Vital Statistics Report*, Volume 70, Number 19. [Online at <https://www.cdc.gov/nchs/data/nvsr/nvsr70/nvsr70-19.pdf>].

<sup>470</sup> U.S. EPA (2021). Estimation of Population Size and Demographic Characteristics among People Living Near Truck Routes in the Conterminous United States. Memorandum to the Docket.

<sup>471</sup> FAF4 includes data from the 2012 Commodity Flow Survey (CFS), the Census Bureau on international trade, as well as data associated with construction, agriculture, utilities, warehouses, and other industries. FAF4 estimates the modal choices for moving goods by trucks, trains, boats, and other types of freight modes. It includes traffic

the population, people living near FAF4 truck routes are more likely to be people of color and have lower incomes than the general population. People living near FAF4 truck routes are also more likely to live in metropolitan areas. Even controlling for region of the country, county characteristics, population density, and household structure, race, ethnicity, and income are significant determinants of whether someone lives near a FAF4 truck route. We note that we did not analyze the population living near warehousing, distribution centers, transshipment, or intermodal freight facilities.

We additionally analyzed national databases that allowed us to evaluate whether homes and schools were located near a major road and whether disparities in exposure may be occurring in these environments. Until 2009, the U.S. Census Bureau's American Housing Survey (AHS) included descriptive statistics of over 70,000 housing units across the nation and asked about transportation infrastructure near respondents' homes every two years.<sup>472</sup><sup>473</sup> We also analyzed the U.S. Department of Education's Common Core of Data (CCD), which includes enrollment and location information for schools across the United States.<sup>474</sup>

In analyzing the 2009 AHS, we focused on whether a housing unit was located within 300 feet of a "4-or-more lane highway, railroad, or airport" (this distance was used in the AHS analysis).<sup>475</sup> We analyzed whether there were differences between households in such locations compared with those in locations farther from these transportation facilities.<sup>476</sup> We included other variables, such as land use

assignments, including truck flows on a network of truck routes. [https://ops.fhwa.dot.gov/freight/freight\\_analysis/faf/](https://ops.fhwa.dot.gov/freight/freight_analysis/faf/).

<sup>472</sup> U.S. Department of Housing and Urban Development, & U.S. Census Bureau. (n.d.). Age of other residential buildings within 300 feet. In American Housing Survey for the United States: 2009 (pp. A-1). Retrieved from <https://www.census.gov/programs-surveys/ahs/data/2009/ahs-2009-summary-tables0/h150-09.html>.

<sup>473</sup> The 2013 AHS again included the "etrams" question about highways, airports, and railroads within half a block of the housing unit but has not maintained the question since then.

<sup>474</sup> <http://nces.ed.gov/ccd/>.

<sup>475</sup> This variable primarily represents roadway proximity. According to the Central Intelligence Agency's World Factbook, in 2010, the United States had 6,506,204 km of roadways, 224,792 km of railways, and 15,079 airports. Highways thus represent the overwhelming majority of transportation facilities described by this factor in the AHS.

<sup>476</sup> Bailey, C. (2011) Demographic and Social Patterns in Housing Units Near Large Highways and Other Transportation Sources. Memorandum to docket.

category, region of country, and housing type. We found that homes with a non-White householder were 22–34 percent more likely to be located within 300 feet of these large transportation facilities than homes with White householders. Homes with a Hispanic householder were 17–33 percent more likely to be located within 300 feet of these large transportation facilities than homes with non-Hispanic householders. Households near large transportation facilities were, on average, lower in income and educational attainment and more likely to be a rental property and located in an urban area compared with households more distant from transportation facilities.

In examining schools near major roadways, we used the CCD from the U.S. Department of Education, which includes information on all public elementary and secondary schools and school districts nationwide.<sup>477</sup> To determine school proximities to major roadways, we used a geographic information system (GIS) to map each school and roadways based on the U.S. Census's TIGER roadway file.<sup>478</sup> We estimated that about 10 million students attend schools within 200 meters of major roads, about 20 percent of the total number of public school students in the United States.<sup>479</sup> About 800,000 students attend public schools within 200 meters of primary roads, or about 2 percent of the total. We found that students of color were overrepresented at schools within 200 meters of primary roadways, and schools within 200 meters of primary roadways had a disproportionate population of students eligible for free or reduced-price lunches.<sup>480</sup> Black students represent 22 percent of students at schools located within 200 meters of a primary road, compared to 17 percent of students in all U.S. schools. Hispanic students represent 30 percent of students at schools located within 200 meters of a

<sup>477</sup> <http://nces.ed.gov/ccd/>.

<sup>478</sup> Pedde, M.; Bailey, C. (2011) Identification of Schools within 200 Meters of U.S. Primary and Secondary Roads. Memorandum to the docket.

<sup>479</sup> Here, "major roads" refer to those TIGER classifies as either "Primary" or "Secondary." The Census Bureau describes primary roads as "generally divided limited-access highways within the Federal interstate system or under state management." Secondary roads are "main arteries, usually in the U.S. highway, state highway, or county highway system."

<sup>480</sup> For this analysis we analyzed a 200-meter distance based on the understanding that roadways generally influence air quality within a few hundred meters from the vicinity of heavily traveled roadways or along corridors with significant trucking traffic. See U.S. EPA, 2014. Near Roadway Air Pollution and Health: Frequently Asked Questions. EPA-420-F-14-044.

primary road, compared to 22 percent of students in all U.S. schools.

We also reviewed existing scholarly literature examining the potential for disproportionate exposure among people of color and people with low socioeconomic status (SES). Numerous studies evaluating the demographics and socioeconomic status of populations or schools near roadways have found that they include a greater percentage of residents of color, as well as lower SES populations (as indicated by variables such as median household income). Locations in these studies include Los Angeles, CA; Seattle, WA; Wayne County, MI; Orange County, FL; the State of California generally; and nationally.<sup>481</sup><sup>482</sup><sup>483</sup><sup>484</sup><sup>485</sup><sup>486</sup><sup>487</sup> Such disparities may be due to multiple factors.<sup>488</sup><sup>489</sup><sup>490</sup><sup>491</sup>

People with low SES often live in neighborhoods with multiple stressors

<sup>481</sup> Marshall, J.D. (2008) Environmental inequality: air pollution exposures in California's South Coast Air Basin.

<sup>482</sup> Su, J.G.; Larson, T.; Gould, T.; Cohen, M.; Buzzelli, M. (2010) Transboundary air pollution and environmental justice: Vancouver and Seattle compared. *GeoJournal* 57: 595–608. doi:10.1007/s10708-009-9269-6.

<sup>483</sup> Chakraborty, J.; Zandbergen, P.A. (2007) Children at risk: measuring racial/ethnic disparities in potential exposure to air pollution at school and home. *J Epidemiol Community Health* 61: 1074–1079. doi:10.1136/jech.2006.054130.

<sup>484</sup> Green, R.S.; Smorodinsky, S.; Kim, J.J.; McLaughlin, R.; Ostro, B. (2004) Proximity of California public schools to busy roads. *Environ Health Perspect* 112: 61–66. doi:10.1289/ehp.6566.

<sup>485</sup> Wu, Y.; Batterman, S.A. (2006) Proximity of schools in Detroit, Michigan to automobile and truck traffic. *J Exposure Sci & Environ Epidemiol*. doi:10.1038/sj.jes.7500484.

<sup>486</sup> Su, J.G.; Jerrett, M.; de Nazelle, A.; Wolch, J. (2011) Does exposure to air pollution in urban parks have socioeconomic, racial, or ethnic gradients? *Environ Res* 111: 319–328.

<sup>487</sup> Jones, M.R.; Diez-Roux, A.; Hajat, A.; et al. (2014) Race/ethnicity, residential segregation, and exposure to ambient air pollution: The Multi-Ethnic Study of Atherosclerosis (MESA). *Am J Public Health* 104: 2130–2137. [Online at: <https://doi.org/10.2105/AJPH.2014.302135>].

<sup>488</sup> Depro, B.; Timmins, C. (2008) Mobility and environmental equity: do housing choices determine exposure to air pollution? Duke University Working Paper.

<sup>489</sup> Rothstein, R. *The Color of Law: A Forgotten History of How Our Government Segregated America*. New York: Liveright, 2018.

<sup>490</sup> Lane, H.J.; Morello-Frosch, R.; Marshall, J.D.; Apte, J.S. (2022) Historical redlining is associated with present-day air pollution disparities in US Cities. *Environ Sci & Technol Letters* 9: 345–350. DOI: [Online at: <https://doi.org/10.1021/acs.estlett.1c01012>].

<sup>491</sup> Ware, L. (2021) Plessy's legacy: the government's role in the development and perpetuation of segregated neighborhoods. *RSF: The Russel Sage Foundation Journal of the Social Sciences*, 7:92–109. DOI: DOI: 10.7758/RSF.2021.7.1.06.

<sup>492</sup> Archer, D.N. (2020) "White Men's Roads through Black Men's Homes": advancing racial equity through highway reconstruction. *Vanderbilt Law Rev* 73: 1259.



and health risk factors, including reduced health insurance coverage rates, higher smoking and drug use rates, limited access to fresh food, visible neighborhood violence, and elevated rates of obesity and some diseases such as asthma, diabetes, and ischemic heart disease. Although questions remain, several studies find stronger associations between air pollution and health in locations with such chronic neighborhood stress, suggesting that populations in these areas may be more susceptible to the effects of air pollution.<sup>493 494 495 496</sup>

Several publications report nationwide analyses that compare the demographic patterns of people who do or do not live near major roadways.<sup>497 498 499 500 501 502</sup> Three of these studies found that people living near major roadways are more likely to be people of color or low in

<sup>493</sup> Clougherty, J.E.; Kubzansky, L.D. (2009) A framework for examining social stress and susceptibility to air pollution in respiratory health. *Environ Health Perspect* 117: 1351–1358. Doi:10.1289/ehp.0900612.

<sup>494</sup> Clougherty, J.E.; Levy, J.I.; Kubzansky, L.D.; Ryan, P.B.; Franco Suglia, S.; Jacobson Canner, M.; Wright, R.J. (2007) Synergistic effects of traffic-related air pollution and exposure to violence on urban asthma etiology. *Environ Health Perspect* 115: 1140–1146. doi:10.1289/ehp.9863.

<sup>495</sup> Finkelstein, M.M.; Jerrett, M.; DeLuca, P.; Finkelstein, N.; Verma, D.K.; Chapman, K.; Sears, M.R. (2003) Relation between income, air pollution and mortality: a cohort study. *Canadian Med Assn J* 169: 397–402.

<sup>496</sup> Shankardass, K.; McConnell, R.; Jerrett, M.; Milam, J.; Richardson, J.; Berhane, K. (2009) Parental stress increases the effect of traffic-related air pollution on childhood asthma incidence. *Proc Natl Acad Sci* 106: 12406–12411. doi:10.1073/pnas.0812910106.

<sup>497</sup> Rowangould, G.M. (2013) A census of the U.S. near-roadway population: public health and environmental justice considerations. *Transportation Research Part D*; 59–67.

<sup>498</sup> Tian, N.; Xue, J.; Barzyk, T.M. (2013) Evaluating socioeconomic and racial differences in traffic-related metrics in the United States using a GIS approach. *J Exposure Sci Environ Epidemiol* 23: 215–222.

<sup>499</sup> CDC (2013) Residential proximity to major highways—United States, 2010. *Morbidity and Mortality Weekly Report* 62(3): 46–50.

<sup>500</sup> Clark, L.P.; Millet, D.B.; Marshall, J.D. (2017) Changes in transportation-related air pollution exposures by race-ethnicity and socioeconomic status: outdoor nitrogen dioxide in the United States in 2000 and 2010. *Environ Health Perspect* <https://doi.org/10.1289/EHP959>.

<sup>501</sup> Mikati, I.; Benson, A.F.; Luben, T.J.; Sacks, J.D.; Richmond-Bryant, J. (2018) Disparities in distribution of particulate matter emission sources by race and poverty status. *Am J Pub Health* <https://ajph.aphapublications.org/doi/abs/10.2105/AJPH.2017.304297?journalCode=ajph>.

<sup>502</sup> Alotaibi, R.; Bechle, M.; Marshall, J.D.; Ramani, T.; Zietsman, J.; Nieuwenhuijsen, M.J.; Khreis, H. (2019) Traffic related air pollution and the burden of childhood asthma in the continuous United States in 2000 and 2010. *Environ International* 127: 858–867. <https://www.sciencedirect.com/science/article/pii/S0160412018325388>.

SES.<sup>503 504 505</sup> They also found that the outcomes of their analyses varied between regions within the United States. However, only one such study looked at whether such conclusions were confounded by living in a location with higher population density and how demographics differ between locations nationwide.<sup>506</sup> In general, it found that higher density areas have higher proportions of low-income residents and people of color. In other publications based on a city, county, or state, the results are similar.<sup>507 508</sup>

Two recent studies provide strong evidence that reducing emissions from heavy-duty vehicles is extremely likely to reduce the disparity in exposures to traffic-related air pollutants, both using NO<sub>2</sub> observations from the recently launched TROPospheric Ozone Monitoring Instrument (TROPOMI) satellite sensor as a measure of air quality, which provides the highest-resolution observations heretofore unavailable from any satellite.<sup>509</sup>

One study evaluated satellite NO<sub>2</sub> concentrations during the COVID–19 lockdowns in 2020 and compared them to NO<sub>2</sub> concentrations from the same dates in 2019.<sup>510</sup> That study found that average NO<sub>2</sub> concentrations were highest in areas with the lowest percentage of White populations, and that the areas with the greatest percentages of non-White or Hispanic populations experienced the greatest declines in NO<sub>2</sub> concentrations during

<sup>503</sup> Tian, N.; Xue, J.; Barzyk, T.M. (2013) Evaluating socioeconomic and racial differences in traffic-related metrics in the United States using a GIS approach. *J Exposure Sci Environ Epidemiol* 23: 215–222.

<sup>504</sup> Rowangould, G.M. (2013) A census of the U.S. near-roadway population: public health and environmental justice considerations. *Transportation Research Part D*; 59–67.

<sup>505</sup> CDC (2013) Residential proximity to major highways—United States, 2010. *Morbidity and Mortality Weekly Report* 62(3): 46–50.

<sup>506</sup> Rowangould, G.M. (2013) A census of the U.S. near-roadway population: public health and environmental justice considerations. *Transportation Research Part D*; 59–67.

<sup>507</sup> Pratt, G.C.; Vadali, M.L.; Kvale, D.L.; Ellickson, K.M. (2015) Traffic, air pollution, minority, and socio-economic status: addressing inequities in exposure and risk. *Int J Environ Res Public Health* 12: 5355–5372. <http://dx.doi.org/10.3390/ijerph120505355>.

<sup>508</sup> Sohrabi, S.; Zietsman, J.; Khreis, H. (2020) Burden of disease assessment of ambient air pollution and premature mortality in urban areas: the role of socioeconomic status and transportation. *Int J Env Res Public Health* doi:10.3390/ijerph17041166.

<sup>509</sup> TROPospheric Ozone Monitoring Instrument (TROPOMI) is part of the Copernicus Sentinel-5 Precursor satellite.

<sup>510</sup> Kerr, G.H.; Goldberg, D.L.; Anenberg, S.C. (2021) COVID–19 pandemic reveals persistent disparities in nitrogen dioxide pollution. *PNAS* 118. [Online at <https://doi.org/10.1073/pnas.2022409118>].

the lockdown. These NO<sub>2</sub> reductions were associated with the density of highways in the local area.

In the second study, satellite NO<sub>2</sub> measured from 2018–2020 was averaged by racial groups and income levels in 52 large U.S. cities.<sup>511</sup> Using census tract-level NO<sub>2</sub>, the study reported average population-weighted NO<sub>2</sub> levels to be 28 percent higher for low-income non-White people compared with high-income White people. The study also used weekday-weekend differences and bottom-up emission estimates to estimate that diesel traffic is the dominant source of NO<sub>2</sub> disparities in the studied cities. Overall, there is substantial evidence that people who live or attend school near major roadways are more likely to be of a non-White race, Hispanic, and/or have a low SES. Although proximity to an emissions source is an indicator of potential exposure, it is important to note that the impacts of emissions from tailpipe sources are not limited to communities in close proximity to these sources. For example, the effects of potential decreases in emissions from sources affected by this final rule might also be felt many miles away, including in communities with EJ concerns. The spatial extent of these impacts depends on a range of interacting and complex factors including the amount of pollutant emitted, atmospheric lifetime of the pollutant, terrain, atmospheric chemistry and meteorology. However, recent studies using satellite-based NO<sub>2</sub> measurements provide evidence that reducing emission from heavy-duty vehicles is likely to reduce disparities in exposure to traffic-related pollution.

## 2. Demographic Analysis of Ozone and PM<sub>2.5</sub> Impacts

When feasible, EPA's Office of Transportation and Air Quality conducts full-scale photochemical air quality modeling to demonstrate how its national mobile source regulatory actions affect ambient concentrations of regional pollutants throughout the United States. As described in RIA Chapter 6.2, the air quality modeling we conducted for the proposal also supports our analysis of future projections of PM<sub>2.5</sub> and ozone concentrations in a “baseline” scenario absent the rule and in a “control”

<sup>511</sup> Demetillo, M.A.; Harkins, C.; McDonald, B.C.; et al. (2021) Space-based observational constraints on NO<sub>2</sub> air pollution inequality from diesel traffic in major US cities. *Geophys Res Lett* 48, e2021GL094333. [Online at <https://doi.org/10.1029/2021GL094333>].

scenario that assumes the rule is in place.<sup>512</sup>

This air quality modeling data can also be used to conduct a demographic analysis of human exposure to future air quality in scenarios with and without the rule in place. Although the spatial resolution of the air quality modeling is not sufficient to capture very local heterogeneity of human exposures, particularly the pollution concentration gradients near roads, the analysis does allow estimates of demographic trends at a national scale. We developed this approach by considering the purpose and specific characteristics of this rulemaking, as well as the nature of known and potential exposures to the air pollutants controlled by the standards. The heavy-duty standards apply nationally and will be implemented consistently across roadways throughout the United States. The pollutant predominantly controlled by the standard is NO<sub>x</sub>. Reducing emissions of NO<sub>x</sub> will reduce formation of ozone and secondarily formed PM<sub>2.5</sub>, which will reduce human exposures to regional concentrations of ambient ozone and PM<sub>2.5</sub>. These reductions will be geographically widespread. Taking these factors into consideration, this demographic analysis evaluates the exposure outcome distributions that will result from this rule at the national scale with a focus on locations that are projected to have the highest baseline concentrations of PM<sub>2.5</sub> and ozone.

To analyze trends in exposure outcomes, we sorted projected 2045 baseline air quality concentrations from highest to lowest concentration and created two groups: Areas within the contiguous United States with the worst air quality (highest 5 percent of concentrations) and the rest of the country. This approach can then answer two principal questions to determine disparity among people of color:

1. What is the demographic composition of areas with the worst baseline air quality in 2045?
2. Are those with the worst air quality benefiting more from the heavy-duty vehicle and engine standards?

We found that in the 2045 baseline, the number of people of color projected

to live within the grid cells with the highest baseline concentrations of ozone (26 million) is nearly double that of non-Hispanic Whites (14 million). Thirteen percent of people of color are projected to live in areas with the worst baseline ozone, compared to seven percent of non-Hispanic Whites. The number of people of color projected to live within the grid cells with the highest baseline concentrations of PM<sub>2.5</sub> (93 million) is nearly double that of non-Hispanic Whites (51 million). Forty-six percent of people of color are projected to live in areas with the worst baseline PM<sub>2.5</sub>, compared to 25 percent of non-Hispanic Whites. We also found that the largest predicted improvements in both ozone and PM<sub>2.5</sub> are estimated to occur in areas with the worst baseline air quality, and that a larger number of people of color are projected to reside in these areas.

EPA received comments related to the methods the Agency used to analyze the distribution of impacts of the heavy-duty vehicle and engine standards. We summarize and respond to those comments in the Response to Comments document that accompanies this rulemaking. After consideration of comments, we have retained our approach used in the proposal for this final rule. However, after considering comments that EPA undertake an analysis of race/ethnicity-stratified impacts, we have added an analysis of the demographic composition of air quality impacts that accrue to specific race and ethnic groups. The result of that analysis found that non-Hispanic Blacks will experience the greatest reductions in PM<sub>2.5</sub> and ozone concentrations as a result of the standards. Chapter 6.6.9 of the RIA describes the data and methods used to conduct the demographic analysis and presents our results in detail.

#### **VIII. Benefits of the Heavy-Duty Engine and Vehicle Standards**

The highway heavy-duty engines and vehicles subject to the final rule are significant sources of mobile source air pollution, including directly-emitted PM<sub>2.5</sub> as well as NO<sub>x</sub> and VOC emissions (both precursors to ozone formation and secondarily-formed PM<sub>2.5</sub>). The final program will reduce exhaust emissions of these pollutants from the regulated engines and vehicles, which will in turn reduce ambient concentrations of ozone and PM<sub>2.5</sub>, as discussed in Sections VI and VII. Exposures to these pollutants are linked to adverse environmental and human health impacts, such as premature deaths and non-fatal illnesses (see Section II).

In this section, we present the quantified and monetized human health benefits from reducing concentrations of ozone and PM<sub>2.5</sub> using the air quality modeling results described in Section VII. As noted in Section VII, we performed full-scale photochemical air quality modeling for the proposal. No further air quality modeling has been conducted to reflect the emissions impacts of the final program. Because air quality modeling results are necessary to quantify estimates of avoided mortality and illness attributable to changes in ambient PM<sub>2.5</sub> and ozone, we present the benefits from the proposal as a proxy for the health benefits associated with the final program. RIA Chapter 5 describes the differences in emissions between those used to estimate the air quality impacts of the proposal and those that will be achieved by the final program. Emission reductions associated with the final program are similar to those used in the air quality modeling conducted for the proposal. We therefore conclude that the health benefits from the proposal are a fair characterization of those that will be achieved due to the substantial improvements in air quality attributable to the final program.

The approach we used to estimate health benefits is consistent with the approach described in the technical support document (TSD) that was published for the final Revised Cross-State Air Pollution Rule (CSAPR) Update RIA.<sup>513</sup> Table VIII-1 and Table VIII-2 present quantified health benefits from reductions in human exposure to ambient PM<sub>2.5</sub> and ozone, respectively, in 2045. Table VIII-3 presents the total monetized benefits attributable to the final rule in 2045. We estimate that in 2045, the annual monetized benefits are \$12 and \$33 billion at a 3 percent discount rate and \$10 and \$30 billion at a 7 percent discount rate (2017 dollars).

There are additional human health and environmental benefits associated with reductions in exposure to ambient concentrations of PM<sub>2.5</sub>, ozone, and NO<sub>2</sub> that EPA has not quantified due to data, resource, or methodological limitations. There are also benefits associated with reductions in air toxic pollutant emissions that result from the final standards, but EPA is not currently able to monetize those impacts due to methodological limitations. The estimated benefits of this rule would be

<sup>512</sup> Air quality modeling was performed for the proposed rule, which used emission reductions that are very similar to the emission reductions projected for the final rule. Given the similar structure of the proposed and final programs, we expect consistent geographic distribution of emissions reductions and modeled improvements in air quality, and that the air quality modeling conducted at the time of proposal adequately represents the final rule. Specifically, we expect this rule will decrease ambient concentrations of air pollutants, including significant improvements in ozone concentrations in 2045 as demonstrated in the air quality modeling analysis.

<sup>513</sup> U.S. Environmental Protection Agency (U.S. EPA). 2021. Estimating PM<sub>2.5</sub>- and Ozone-Attributable Health Benefits. Technical Support Document (TSD) for the Final Revised Cross-State Air Pollution Rule Update for the 2008 Ozone Season NAAQS. EPA-HQ-OAR-2020-0272. March.

larger if we were able to monetize all unquantified benefits at this time. EPA received several comments related to the methods the Agency used to estimate the benefits of the proposal. We summarize and respond to those

comments in the Response to Comments document that accompanies this rulemaking. After consideration of comments, we have retained our approach to estimating benefits and

have not made any changes to the analysis. For more detailed information about the benefits analysis conducted for this rule, please refer to RIA Chapter 8 that accompanies this preamble.

TABLE VIII–1—ESTIMATED AVOIDED PM<sub>2.5</sub> MORTALITY AND ILLNESSES FOR 2045  
[95 Percent confidence interval]<sup>ab</sup>

	Avoided health incidence
<b>Avoided premature mortality:</b>	
Turner et al. (2016)—Ages 30+ .....	740 (500 to 980).
Di et al. (2017)—Ages 65+ .....	800 (780 to 830).
Woodruff et al. (2008)—Ages <1 .....	4.1 (– 2.6 to 11).
<b>Non-fatal heart attacks among adults:</b>	
Short-term exposure:	
Peters et al. (2001) .....	790 (180 to 1,400).
Pooled estimate .....	85 (31 to 230).
<b>Morbidity effects:</b>	
Long-term exposure:	
Asthma onset .....	1,600 (1,500 to 1,600).
Allergic rhinitis symptoms .....	10,000 (2,500 to 18,000)
Stroke .....	41 (11 to 70).
Lung cancer .....	52 (16 to 86).
Hospital Admissions—Alzheimer’s disease .....	400 (300 to 500).
Hospital Admissions—Parkinson’s disease .....	43 (22 to 63).
Short-term exposure:	
Hospital admissions—cardiovascular .....	110 (76 to 130).
ED visits—cardiovascular .....	210 (– 82 to 500).
Hospital admissions—respiratory .....	68 (23 to 110).
ED visits—respiratory .....	400 (78 to 830).
Asthma symptoms .....	210,000 (– 100,000 to 520,000).
Minor restricted-activity days .....	460,000 (370,000 to 550,000).
Cardiac arrest .....	10 (– 4.2 to 24).
Lost work days .....	78,000 (66,000 to 90,000).

<sup>a</sup> Values rounded to two significant figures.

<sup>b</sup> PM<sub>2.5</sub> exposure metrics are not presented here because all PM health endpoints are based on studies that used daily 24-hour average concentrations. Annual exposures are estimated using daily 24-hour average concentrations.

TABLE VIII–2—ESTIMATED AVOIDED OZONE MORTALITY AND ILLNESSES FOR 2045  
[95 Percent confidence interval]<sup>a</sup>

	Metric and season <sup>b</sup>	Avoided health incidence
<b>Avoided premature mortality:</b>		
Long-term exposure:		
Turner et al. (2016) .....	MDA8; April–September .....	2,100 (1,400 to 2,700).
Short-term exposure:		
Katsouyanni et al. (2009) .....	MDA1; April–September .....	120 (– 69 to 300).
<b>Morbidity effects:</b>		
Long-term exposure:		
Asthma onset <sup>c</sup> .....	MDA8; June–August .....	16,000 (14,000 to 18,000).
Short-term exposure:		
Allergic rhinitis symptoms .....	MDA8; May–September .....	88,000 (47,000 to 130,000).
Hospital admissions—respiratory .....	MDA1; April–September .....	350 (– 91 to 770).
ED visits—respiratory .....	MDA8; May–September .....	5,100 (1,400 to 11,000).
Asthma symptoms—Cough <sup>d</sup> .....	MDA8; May–September .....	920,000 (– 50,000 to 1,800,000).
Asthma symptoms—Chest Tightness <sup>d</sup> .....	MDA8; May–September .....	770,000 (85,000 to 1,400,000).
Asthma symptoms—Shortness of Breath <sup>d</sup> .....	MDA8; May–September .....	390,000 (– 330,000 to 1,100,000).
Asthma symptoms—Wheeze <sup>d</sup> .....	MDA8; May–September .....	730,000 (– 57,000 to 1,500,000).
Minor restricted-activity days <sup>d</sup> .....	MDA1; May–September .....	1,600,000 (650,000 to 2,600,000).
School absence days .....	MDA8; May–September .....	1,100,000 (– 150,000 to 2,200,000).

<sup>a</sup> Values rounded to two significant figures.

<sup>b</sup> MDA8—maximum daily 8-hour average; MDA1—maximum daily 1-hour average. Studies of ozone vary with regards to season, limiting analyses to various definitions of summer (e.g., April–September, May–September or June–August). These differences can reflect state-specific ozone seasons, EPA-defined seasons or another seasonal definition chosen by the study author. The paucity of ozone monitoring data in winter months complicates the development of full year projected ozone surfaces and limits our analysis to only warm seasons.

<sup>c</sup> The underlying metric associated with this risk estimate is daily 8-hour average from 10 a.m.–6 p.m. (AVG8); however, we ran the study with a risk estimate converted to MDA8.

<sup>d</sup> Applied risk estimate derived from full year exposures to estimates of ozone across a May–September ozone season. When risk estimates based on full-year, long-term ozone exposures are applied to warm season air quality projections, the resulting benefits assessment may underestimate impacts, due to a shorter timespan for impacts to accrue.

TABLE VIII-3—TOTAL OZONE AND PM<sub>2.5</sub>-ATTRIBUTABLE BENEFITS IN 2045  
 [95 Percent confidence interval; billions of 2017\$]<sup>a b</sup>

	Total annual benefits in 2045		
3% Discount Rate .....	\$12 (\$0.72 to \$31) <sup>c</sup>	and	\$33 (\$3.5 to \$87) <sup>d</sup>
7% Discount Rate .....	\$10 (\$0.37 to \$28) <sup>c</sup>	and	\$30 (\$3.0 to \$78) <sup>d</sup>

<sup>a</sup> The benefits associated with the standards presented here do not include the full complement of health and environmental benefits that, if quantified and monetized, would increase the total monetized benefits.

<sup>b</sup> Values rounded to two significant figures. The two benefits estimates separated by the word “and” signify that they are two separate estimates. The estimates do not represent lower- and upper-bound estimates though they do reflect a grouping of estimates that yield more and less conservative benefit totals. They should not be summed.

<sup>c</sup> Sum of benefits using the Katsouyanni et al. (2009) short-term exposure ozone respiratory mortality risk estimate and the Turner et al. (2016) long-term exposure PM<sub>2.5</sub> all-cause risk estimate.

<sup>d</sup> Sum of benefits using the Turner et al. (2016) long-term exposure ozone respiratory mortality risk estimate and the Di et al. (2017) long-term exposure PM<sub>2.5</sub> all-cause risk estimate.

The full-scale criteria pollutant benefits analysis that was conducted for the proposal, and is presented here, reflects spatially and temporally allocated emissions inventories (see RIA Chapter 5), photochemical air quality modeling (see RIA Chapter 6), and PM<sub>2.5</sub> and ozone benefits generated using EPA’s Environmental Benefits Mapping and Analysis Program—Community Edition (BenMAP-CE) (see RIA Chapter 8),<sup>514</sup> all for conditions projected to occur in calendar year 2045. As we presented in Sections V and VI, national estimates of program costs and emissions were generated for each analysis year from the final rule’s implementation to a year when the final rule will be fully phased-in and the vehicle fleet is approaching full turnover (2027–2045). The

computational requirements needed to conduct photochemical air quality modeling to support a full-scale benefits analysis for analysis years from 2027 to 2044 precluded the Agency from conducting benefits analyses comparable to the proposal’s benefits analysis for calendar year 2045. Instead, we use a reduced-form approach to scale total benefits in 2045 back to 2027 using projected reductions in year-over-year NO<sub>x</sub> emissions so we can estimate the present and annualized values of the stream of estimated benefits for the final rule.<sup>515</sup> For more information on the benefits scaling approach we applied to estimate criteria pollutant benefits over time, please refer to RIA Chapter 8.6 that accompanies this preamble.

Table VIII-4 and Table VIII-5 present the annual, estimated undiscounted

total health benefits (PM<sub>2.5</sub> plus ozone) for the stream of years beginning with the first year of rule implementation, 2027, through 2045. The tables also display the present and annualized values of benefits over this time series, discounted using both 3 percent and 7 percent discount rates and reported in 2017 dollars. Table VIII-4 presents total benefits as the sum of short-term ozone respiratory mortality benefits for all ages, long-term PM<sub>2.5</sub> all-cause mortality benefits for ages 30 and above, and all monetized avoided illnesses. Table VIII-5 presents total benefits as the sum of long-term ozone respiratory mortality benefits for ages 30 and above, long-term PM<sub>2.5</sub> all-cause mortality benefits for ages 65 and above, and all monetized avoided illnesses.

TABLE VIII-4—UNDISCOUNTED STREAM AND PRESENT VALUE OF HUMAN HEALTH BENEFITS FROM 2027 THROUGH 2045: MONETIZED BENEFITS QUANTIFIED AS SUM OF SHORT-TERM OZONE RESPIRATORY MORTALITY AGES 0–99, AND LONG-TERM PM<sub>2.5</sub> ALL-CAUSE MORTALITY AGES 30+

[Discounted at 3 percent and 7 percent; billions of 2017\$]<sup>a b</sup>

	Monetized benefits	
	3% Discount rate	7% Discount rate
2027 .....	\$0.66	\$0.59
2028 .....	1.4	1.2
2029 .....	2.1	1.9
2030 .....	2.8	2.6
2031 .....	3.8	3.4
2032 .....	4.8	4.3
2033 .....	5.5	5.0
2034 .....	6.2	5.6
2035 .....	6.9	6.2
2036 .....	7.5	6.7
2037 .....	8.0	7.2
2038 .....	8.6	7.7
2039 .....	9.1	8.2
2040 .....	9.6	8.7

<sup>514</sup> BenMAP-CE is an open-source computer program that calculates the number and economic value of air pollution-related deaths and illnesses. The software incorporates a database that includes many of the concentration-response relationships, population files, and health and economic data

needed to quantify these impacts. More information about BenMAP-CE, including downloadable versions of the tool and associated user manuals, can be found at EPA’s website [www.epa.gov/benmap](http://www.epa.gov/benmap).

<sup>515</sup> Because NO<sub>x</sub> is the dominant pollutant controlled by the final rule, we make a simplifying assumption that total PM and ozone benefits can be scaled by NO<sub>x</sub> emissions, even though emissions of other pollutants are controlled in smaller amounts by the final rule.

TABLE VIII-4—UNDISCOUNTED STREAM AND PRESENT VALUE OF HUMAN HEALTH BENEFITS FROM 2027 THROUGH 2045: MONETIZED BENEFITS QUANTIFIED AS SUM OF SHORT-TERM OZONE RESPIRATORY MORTALITY AGES 0–99, AND LONG-TERM PM<sub>2.5</sub> ALL-CAUSE MORTALITY AGES 30+—Continued

[Discounted at 3 percent and 7 percent; billions of 2017\$]<sup>a b</sup>

	Monetized benefits	
	3% Discount rate	7% Discount rate
2041 .....	10	9.0
2042 .....	10	9.4
2043 .....	11	9.7
2044 .....	11	10
2045 <sup>c</sup> .....	12	10
Present Value .....	91	53
Annualized Value .....	6.3	5.1

<sup>a</sup> The benefits associated with the standards presented here do not include the full complement of health and environmental benefits that, if quantified and monetized, would increase the total monetized benefits.

<sup>b</sup> Benefits calculated as value of avoided: PM<sub>2.5</sub>-attributable deaths (quantified using a concentration-response relationship from the Turner et al. 2016 study); Ozone-attributable deaths (quantified using a concentration-response relationship from the Katsouyanni et al. 2009 study); and PM<sub>2.5</sub> and ozone-related morbidity effects.

<sup>c</sup> Year in which PM<sub>2.5</sub> and ozone air quality was simulated (2045).

TABLE VIII-5—UNDISCOUNTED STREAM AND PRESENT VALUE OF HUMAN HEALTH BENEFITS FROM 2027 THROUGH 2045: MONETIZED BENEFITS QUANTIFIED AS SUM OF LONG-TERM OZONE RESPIRATORY MORTALITY AGES 30+, AND LONG-TERM PM<sub>2.5</sub> ALL-CAUSE MORTALITY AGES 65+

[Discounted at 3 percent and 7 percent; billions of 2017\$]<sup>a b</sup>

	Monetized benefits	
	3% Discount rate	7% Discount rate
2027 .....	\$1.8	\$1.6
2028 .....	3.7	3.3
2029 .....	5.7	5.1
2030 .....	7.9	7.1
2031 .....	11	9.6
2032 .....	13	12
2033 .....	16	14
2034 .....	18	16
2035 .....	19	17
2036 .....	21	19
2037 .....	23	21
2038 .....	25	22
2039 .....	26	23
2040 .....	28	25
2041 .....	29	26
2042 .....	30	27
2043 .....	31	28
2044 .....	32	29
2045 <sup>c</sup> .....	33	30
Present Value .....	260	150
Annualized Value .....	18	14

<sup>a</sup> The benefits associated with the standards presented here do not include the full complement of health and environmental benefits that, if quantified and monetized, would increase the total monetized benefits.

<sup>b</sup> Benefits calculated as value of avoided: PM<sub>2.5</sub>-attributable deaths (quantified using a concentration-response relationship from the Di et al. 2017 study); Ozone-attributable deaths (quantified using a concentration-response relationship from the Turner et al. 2016 study); and PM<sub>2.5</sub> and ozone-related morbidity effects.

<sup>c</sup> Year in which PM<sub>2.5</sub> and ozone air quality was simulated (2045).

This analysis includes many data sources as inputs that are each subject to uncertainty. Input parameters include projected emission inventories, air quality data from models (with their associated parameters and inputs), population data, population estimates, health effect estimates from epidemiology studies, economic data, and assumptions regarding the future

state of the world (*i.e.*, regulations, technology, and human behavior). When compounded, even small uncertainties can greatly influence the size of the total quantified benefits. Please refer to RIA Chapter 8 for more information on the uncertainty associated with the benefits presented here.

**IX. Comparison of Benefits and Costs**

This section compares the estimated range of total monetized health benefits to total costs associated with the final rule. This section also presents the range of monetized net benefits (benefits minus costs) associated with the final rule. Program costs are detailed and presented in Section V of this preamble.

Those costs include costs for both the new technology and the operating costs associated with that new technology, as well as costs associated with the final rule's warranty and useful life provisions. Program benefits are presented in Section VIII. Those benefits are the monetized economic value of the reduction in PM<sub>2.5</sub>- and ozone-related premature deaths and illnesses that result from reductions in NO<sub>x</sub> emissions and directly emitted PM<sub>2.5</sub> attributable to implementation of the final rule.

As noted in Section II and Sections V through VIII, these estimated benefits, costs, and net benefits do not reflect all the anticipated impacts of the final rule.<sup>516 517</sup>

**A. Methods**

EPA presents three different benefit-cost comparisons for the final rule:

1. A future-year snapshot comparison of annual benefits and costs in the year 2045, chosen to approximate the annual

health benefits that will occur in a year when the program will be fully implemented and when most of the regulated fleet will have turned over. Benefits, costs and net benefits are presented in year 2017 dollars and are not discounted. However, 3 percent and 7 percent discount rates were applied in the valuation of avoided premature deaths from long-term pollution exposure to account for a twenty-year segmented cessation lag.

2. The present value (PV) of the stream of benefits, costs and net benefits calculated for the years 2027–2045, discounted back to the first year of implementation of the final rule (2027) using both a 3 percent and 7 percent discount rate, and presented in year 2017 dollars. Note that year-over-year costs are presented in Section V and year-over-year benefits can be found in Section VIII.

3. The equivalent annualized value (EAV) of benefits, costs and net benefits

representing a flow of constant annual values that, had they occurred in each year from 2027 to 2045, will yield an equivalent present value to the present value estimated in method 2 (using either a 3 percent or 7 percent discount rate). Each EAV represents a typical benefit, cost or net benefit for each year of the analysis and is presented in year 2017 dollars.

The two estimates of monetized benefits (and net benefits) in each of these benefit-cost comparisons reflect alternative combinations of the economic value of PM<sub>2.5</sub>- and ozone-related premature deaths summed with the economic value of illnesses for each discount rate (see RIA Chapter 8 for more detail).

**B. Results**

Table IX–1 presents the benefits, costs and net benefits of the final rule in annual terms for year 2045, in PV terms, and in EAV terms.

**TABLE IX–1—ANNUAL VALUE, PRESENT VALUE AND EQUIVALENT ANNUALIZED VALUE OF COSTS, BENEFITS AND NET BENEFITS OF THE FINAL RULE**  
[billions, 2017\$]<sup>a b</sup>

	3% Discount	7% Discount
<b>2045:</b>		
Benefits .....	\$12–\$33	\$10–\$30
Costs .....	4.7	4.7
Net Benefits .....	6.9–29	5.8–25
<b>Present Value:</b>		
Benefits .....	91–260	53–150
Costs .....	55	39
Net Benefits .....	36–200	14–110
<b>Equivalent Annualized Value:</b>		
Benefits .....	6.3–18	5.1–14
Costs .....	3.8	3.8
Net Benefits .....	2.5–14	1.3–11

<sup>a</sup> All benefits estimates are rounded to two significant figures; numbers may not sum due to independent rounding. The range of benefits (and net benefits) in this table are two separate estimates and do not represent lower- and upper-bound estimates, though they do reflect a grouping of estimates that yield more and less conservative benefits totals. The costs and benefits in 2045 are presented in annual terms and are not discounted. However, all benefits in the table reflect a 3 percent and 7 percent discount rate used to account for cessation lag in the valuation of avoided premature deaths associated with long-term exposure.

<sup>b</sup> The benefits associated with the standards presented here do not include the full complement of health and environmental benefits that, if quantified and monetized, would increase the total monetized benefits.

Annual benefits are larger than the annual costs in 2045, with annual net benefits of \$5.8 and \$25 billion using a 7 percent discount rate, and \$6.9 and \$29 billion using a 3 percent discount rate.<sup>518</sup> Benefits also outweigh the costs when expressed in PV terms (net benefits of \$14 and \$110 billion using a 7 percent discount rate, and \$36 and \$200 billion using a 3 percent discount rate) and EAV terms (net benefits of \$1.3

and \$11 billion using a 7 percent discount rate, and \$2.5 and \$14 billion using a 3 percent discount rate).

Given these results, implementation of the final rule will provide society with a substantial net gain in welfare, notwithstanding the health and other benefits we were unable to quantify (see RIA Chapter 8.7 for more information about unquantified benefits). EPA does not expect the omission of unquantified

benefits to impact the Agency's evaluation of the costs and benefits of the final rule, though net benefits would be larger if unquantified benefits were monetized.

**X. Economic Impact Analysis**

This section describes our Economic Impact Analysis for the final rule. Our analysis focuses on the potential impacts of the standards on heavy-duty

<sup>516</sup> As detailed in RIA Chapter 8, estimates of health benefits are based on air quality modeling conducted for the proposal, and thus differences between the proposal and final rule are not reflected in the benefits analysis. We have concluded, however, that the health benefits estimated for the proposal are a fair characterization

of the benefits that will be achieved due to the substantial improvements in air quality attributable to the final rule.

<sup>517</sup> EPA's analysis of costs and benefits does not include California's Omnibus rule or actions by other states to adopt it. EPA is reviewing a waiver request under CAA section 209(b) from California

for the Omnibus rule; until EPA grants the waiver, the HD Omnibus program is not enforceable.

<sup>518</sup> The range of benefits and net benefits presented in this section reflect a combination of assumed PM<sub>2.5</sub> and ozone mortality risk estimates and selected discount rate.

(HD) vehicles (sales, mode shift, fleet turnover) and employment in the HD industry. This section describes our evaluation.

#### A. Impact on Vehicle Sales, Mode Shift, and Fleet Turnover

This final rulemaking will require HD engine manufacturers to develop and implement emission control technologies capable of controlling NO<sub>x</sub> at lower levels over longer emission warranty and regulatory useful life periods. These changes in requirements will increase the cost of producing and selling compliant HD vehicles. These increased costs are likely to lead to increases in prices for HD vehicles, which might lead to reductions in truck sales. In addition, there may be a period of “pre-buying” in anticipation of potentially higher prices, during which there is an increase in new vehicle purchases before the implementation of new requirements, followed by a period of “low-buying” directly after implementation, during which new vehicle purchases decrease. EPA acknowledges that the final rule may lead to some pre-buy before the implementation date of the standards, and some low-buy after the standards are implemented. EPA is unable to estimate sales impacts based on existing literature, and as such contracted with ERG to complete a literature review, as well as conduct original research to estimate sales impacts for previous EPA HD vehicle rules on pre- and low-buy for HD vehicles. The resulting analysis examines the effect of four HD truck regulations, those that became effective in 2004, 2007, 2010 and 2014, on the sales of Class 6, 7 and 8 vehicles over the twelve months before and after each standard. The rules with implementation dates in 2004, 2007 and 2010 focused on reducing criteria pollutant emissions. The 2014 regulation focused on reducing GHG emissions. The report finds little evidence of sales impacts for Class 6 and 7 vehicles. For Class 8 vehicles, evidence of pre-buy was found before the 2010 and 2014 standards’ implementation dates, and evidence of low-buy was found after the 2002, 2007 and 2010 standards’ implementation dates. Based on the results of this study, EPA outlined an approach in the RIA that could be used to estimate pre- and low-buy effects. In the RIA, we explain the methods used to estimate sales effects, as well as how the results can be applied to a regulatory analysis (see the RIA, Chapter 10.1, for further discussion). Our results for the final standards suggest pre- and low-buy for Class 8 trucks may range from zero to

approximately two percent increase in sales over a period of up to 8 months before the final standards become effective for MY 2027 (pre-buy), and a decrease in sales from zero to just under three percent over a period of up to 12 months after the standards begin (low-buy).

In response to our request for comment in the NPRM on the approach to estimate sales effects discussed in the RIA, some commenters stated that EPA estimates of pre- and low-buy in the draft RIA were underestimated, citing results from ACT Research. The estimated costs used by ACT Research were significantly higher than those estimated by EPA in the NPRM, which led, in part, to higher estimated sales effects. Another commenter pointed out limitations in EPA’s approach that could lead to overestimates of sales effects, and they recommended removing the quantitative analysis of sales effects. We believe that despite its limitations, EPA’s peer-reviewed approach continues to be appropriate given the data and literature that are currently available. In addition, the EPA peer-reviewed study and method used to estimate illustrative results in Chapter 10 of the RIA is transparent, reproducible, and “is based on the best reasonably obtainable scientific, technical, and economic information available,” in compliance with OMB Circular A–4.<sup>519</sup> The model and assumptions used by ACT Research did not include sufficient detail for EPA to evaluate or replicate that approach, and the other commenter’s suggestions of how to improve EPA’s approach are not currently feasible with available data. Furthermore, our analysis is clear that the lower bound is zero (*i.e.*, there may be no sales effect). For further detail regarding these comments and EPA’s response to the costs estimates cited by commenters, see Section 18 of the Response to Comments. For information on costs estimated in this final rule, see Chapter 7 of the RIA. For further information on comments EPA received and EPA’s response to comments on our sales effects analysis, see Section 25 of the Response to Comments.

In addition to potential sales impacts from changes in purchase price, the requirement for longer useful life and emission warranty periods may also affect vehicle sales. While longer emission warranty periods and useful life are likely to increase the purchase price of new HD vehicles, these

increases may be offset by reduced operating costs. This is because longer useful life periods are expected to make emission control technology components more durable, and more durable components, combined with manufacturers paying for repairs during the longer warranty periods, will in turn reduce repair costs for vehicle owners. These combined effects may increase (or reduce the decrease in) sales of new HD vehicles if fleets and independent owner-operators prefer to purchase more durable vehicles with overall lower repair costs.<sup>520</sup> EPA is unable to quantify these effects because existing literature does not provide sufficient insight on the relationship between warranty changes, increases in prices due to increased warranty periods, and sales impacts. EPA continues to investigate methods for estimating sales impacts of longer emission warranty periods and useful life. See the RIA, Chapter 10.1.1, for more information.

Another potential effect of the final standards is transportation mode shift, which is a change from using a heavy duty-truck to using another mode of transportation (typically rail or marine). Whether shippers switch to a different transportation mode for freight depends not only on the cost per mile of the shipment (freight rate), but also the value of the shipment, the time needed for shipment, and the availability of supporting infrastructure. This final rule is not expected to have a large impact on truck freight rates given that the price of the truck is only a small part of the cost per mile of a ton of goods. For that reason, we expect little mode shift due to the final standards. The RIA, Chapter 10.1.3, discusses this issue.

An additional potential area of impact of the standards is on fleet turnover and the associated reduction in emissions from new vehicles. After implementation of the final standards, each individual new vehicle sold will produce lower emissions per mile relative to legacy vehicles. However, the standards will reduce total HD highway fleet emissions gradually. This is because, initially, the vehicles meeting the final standards will only be a small portion of the total fleet; over time, as more vehicles subject to the standards enter the market and older vehicles leave the market, greater emission reductions will occur. If pre-buy and low-buy behaviors occur, then the initial emission reductions are likely to be smaller than expected. This is

<sup>519</sup> OMB Circular A–4 (found at [https://obamawhitehouse.archives.gov/omb/circulars\\_a004\\_a-4/#d](https://obamawhitehouse.archives.gov/omb/circulars_a004_a-4/#d)) provides guidance to Federal Agencies on the development of regulatory analyses as required under Executive Order 12866.

<sup>520</sup> The reduced repair costs may counteract some of the sales effect of increased vehicle purchase cost. As a result, they may reduce incentives for pre- and low-buy and mitigate adverse sales impacts.

because, under pre-buy conditions, the pre-bought vehicles will be certified to less stringent standards and their emission reductions will be smaller than what will be realized if those vehicles were subject to the final standards. However, the new vehicles are likely less polluting than the older vehicles that they are most likely to displace, and there may be an earlier reduction in emissions than would have occurred without the standards since the vehicles are being purchased ahead of the implementation of new standards, rather than at a natural point in the purchase cycle. Under low-buy, emission reductions will be slower because there is slower adoption of new vehicles than without the standards. See the RIA, Chapter 10.1.2, for more information on this, as well as the discussion in this section related to vehicle miles traveled (VMT).

The standards may also result in a net reduction in new vehicle sales if there is either a smaller pre-buy than a post-standards low-buy, or some potential buyers decide not to purchase at all. In this case, the VMT of vehicles in the existing fleet may increase to compensate for the “missing” vehicles. However, since we expect this effect to be small, to the extent it might exist, we expect the total effect on emissions reductions to be small.

### B. Employment Impacts

This section discusses potential employment impacts due to this regulation, as well as our partial estimates of those impacts. We focus our analysis on the motor vehicle manufacturing and the motor vehicle parts manufacturing sectors because these sectors are most directly affected.<sup>521</sup> While the final rule primarily affects heavy duty vehicle engines, the employment effects are expected to be felt more broadly in the motor vehicle and parts sectors due to the effects of the standards on sales.

In general, the employment effects of environmental regulation are difficult to disentangle from other economic changes (especially the state of the macroeconomy) and business decisions that affect employment, both over time and across regions and industries. In light of these difficulties, we look to economic theory to provide a constructive framework for approaching these assessments and for better

understanding the inherent complexities in such assessments.

Economic theory of labor demand indicates that employers affected by environmental regulation may change their demand for different types of labor in different ways. They may increase their demand for some types, decrease demand for other types, or maintain demand for still other types. To present a complete picture, an employment impact analysis describes both positive and negative changes in employment. A variety of conditions can affect employment impacts of environmental regulation, including baseline labor market conditions, employer and worker characteristics, industry, and region.

In the RIA, we describe three ways employment at the firm level might be affected by changes in a firm’s production costs due to environmental regulation: A demand effect, caused by higher production costs increasing market prices and decreasing demand; a cost effect, caused by additional environmental protection costs leading regulated firms to increase their use of inputs; and a factor-shift effect, in which post-regulation production technologies may have different labor intensities than their pre-regulation counterparts.<sup>522 523</sup>

Due to data limitations, EPA is not quantifying the impacts of the final regulation on firm-level employment for affected companies, although we acknowledge these potential impacts. Instead, we discuss factor-shift, demand, and cost employment effects for the regulated sector at the industry level in the RIA. Factor-shift effects are due to changes in labor intensity of production due to the standards. We do not have information on how regulations might affect labor intensity of production, and therefore we cannot estimate the factor-shift effect on employment. Demand effects on employment are due to changes in labor due to changes in demand. In general, if the regulation causes HD sales to decrease, fewer people would be needed to assemble trucks and to manufacture their components. If pre-buy occurs, HD vehicle sales may increase temporarily in advance of the standards, leading to

temporary increases in employment, but if low-buy occurs following the standards, there could be temporary decreases in employment. We outlined a method to quantify sales impacts, though we are not using it to estimate effects on fleet turnover in this rulemaking. As such, we do not estimate the demand-effect impact on employment due to the standards. However, after consideration of comments, we have added an explanation of a method to Chapter 10.2 of the RIA that could be used to estimate sales effects on employment. We also extend the illustrative sales effects results to show how that method could be used to estimate demand employment effects of this final rule. These results, to the extent they occur, should be interpreted as short-term effects, due to the short-term nature of pre- and low-buy, with a lower-bound of no change in employment due to no change in sales. If the maximum estimated total change in sales were to occur, our illustrative results suggest that this level of pre-buy could lead to an increase of up to about 450 job-years before implementation in 2027, and the maximum level of low-buy could lead to a decrease of up to about 640 job-years after implementation regulation.

Cost effects on employment are due to changes in labor associated with increases in costs of production, and we do estimate a partial employment impact due to changes in cost. This cost effect includes the impact on employment due to the increase in production costs needed for vehicles to meet the standards. (Note that this analysis is separate from any employment effect due to changes in vehicle sales; in other words, the analysis holds output constant.) In the RIA, we capture these effects using the historic share of labor as a part of the cost of production to extrapolate future estimates of the share of labor as a cost of production. This provides a sense of the order of magnitude of expected impacts on employment.

These estimates are averages, covering all the activities in these sectors. The estimates may not be representative of the labor effects when expenditures are required on specific activities, or when manufacturing processes change sufficiently that labor intensity changes. In addition, these estimates do not include changes in industries that supply these sectors, such as steel or electronics producers, or in other potentially indirectly affected sectors (such as shipping). Other sectors that sell, purchase, or service HD vehicles may also face employment impacts due to the standards. The effects on these

<sup>522</sup> Morgenstern, Richard D., William A. Pizer, and Jhih-Shyang Shih (2002). “Jobs Versus the Environment: An Industry-Level Perspective.” *Journal of Environmental Economics and Management* 43: 412–436.

<sup>523</sup> Berman and Bui have a similar framework in which they consider output and substitution effects that are similar to Morgenstern et al.’s three effect (Berman, E. and L.T. M. Bui (2001). “Environmental Regulation and Labor Demand: Evidence from the South Coast Air Basin.” *Journal of Public Economics* 79(2): 265–295).

<sup>521</sup> The employment analysis in the RIA is part of the EPA’s ongoing effort to “conduct continuing evaluations of potential loss or shifts of employment which may result from the administration or enforcement of [the Act]” pursuant to CAA section 321(a).



sectors will depend on the degree to which compliance costs are passed through to prices for HD vehicles and the effects of warranty and useful life requirements on demand for vehicle repair and maintenance. EPA does not have data to estimate the full range of possible employment impacts. For more information on how we estimate the employment impacts due to increased costs, see Chapter 10 of the RIA.

We estimated employment effects due to increases in vehicle costs, based on the ratio of labor to production costs derived from historic data for the final rule. Results are provided in job-years, where a job-year is, for example, one year of full-time work for one person, or one year of half-time work for two people. Increased cost of vehicles and parts will, by itself and holding labor intensity constant, be expected to increase employment by 1,000 to 5,300 job years in 2027, with effects decreasing every year after, see Chapter 10 of the RIA for details.

While we estimate employment impacts, measured in job-years, beginning with program implementation, some of these employment gains may occur earlier as vehicle manufacturers and parts suppliers hire staff in anticipation of compliance with the standards. Additionally, holding all other factors constant, demand-effect employment may increase prior to MY 2027 due to pre-buy, and may decrease, potentially temporarily, afterwards.<sup>524</sup> We present a range of possible results because our analysis consists of data from multiple industrial sectors that we expect will be directly affected by the final regulation, as well as data from multiple sources. For more information on the data we use to estimate the cost effect, see Chapter 10.2 of the RIA.

## XI. Other Amendments

This section describes several amendments to correct, clarify, and streamline a wide range of regulatory provisions for many different types of engines, vehicles, and equipment.<sup>525</sup> Section XI.A includes technical amendments to compliance provisions that apply broadly across EPA's emission control programs to multiple

<sup>524</sup> Note that the standards are not expected to provide incentives for manufacturers to shift employment between domestic and foreign production. This is because the standards will apply to vehicles sold in the U.S. regardless of where they are produced.

<sup>525</sup> A docket memo includes redline text to highlight all the changes to the regulations in the final rule. See "Redline Document Showing Final Changes to Regulatory Text in the Heavy-Duty 2027 Rule", EPA memorandum from Alan Stout to Docket EPA-HQ-OAR-2019-0055.

industry sectors, including light-duty vehicles, light-duty trucks, marine diesel engines, locomotives, and various types of nonroad engines, vehicles, and equipment. Some of those amendments are for broadly applicable testing and compliance provisions in 40 CFR parts 1065, 1066, and 1068. Other cross-sector issues involve making the same or similar changes in multiple standard-setting parts for individual industry sectors.

We are adopting amendments in two areas of note for the general compliance provisions in 40 CFR part 1068. First, we are adopting a comprehensive approach for making confidentiality determinations related to compliance information that EPA collects from companies. We are applying these confidentiality determination provisions for all highway, nonroad, and stationary engine, vehicle, and equipment programs, as well as aircraft and portable fuel containers. Second, we are adopting provisions that include clarifying text to establish what qualifies as an adjustable parameter and to identify the practically adjustable range for those adjustable parameters. The final rule includes specific provisions related to electronic controls that aim to deter tampering.

The rest of Section XI describes amendments that apply uniquely to individual industry sectors. These amendments apply to heavy-duty highway engines and vehicles, light-duty motor vehicles, large nonroad SI engines, small nonroad SI engines, recreational vehicles and nonroad equipment, marine diesel engines, locomotives, and stationary emergency CI engines.

### A. General Compliance Provisions (40 CFR Part 1068) and Other Cross-Sector Issues

The regulations in 40 CFR part 1068 include compliance provisions that apply broadly across EPA's emission control programs for engines, vehicles, and equipment. This section describes several amendments to these regulations. This section also includes amendments that make the same or similar changes in multiple standard-setting parts for individual industry sectors or other related portions of the CFR. The following sections describe these cross-sector issues.

#### 1. Confidentiality Determinations

EPA adopts emission standards and corresponding certification requirements and compliance provisions that apply to on-highway CI and SI engines (such as those adopted in this action for on-highway heavy-

duty engines) and vehicles, and to stationary and nonroad CI and SI engines, vehicles, and equipment.<sup>526</sup> This final rule amends our regulations, including 40 CFR parts 2 and 1068 and the standard-setting parts,<sup>527</sup> to establish a broadly applicable set of confidentiality determinations by categories of information, through rulemaking. Under this final rule, EPA is determining that certain information manufacturers must submit (or EPA otherwise collects) under the standard-setting parts including for certification, compliance oversight, and in response to certain enforcement activities,<sup>528</sup> is either emission data or otherwise not entitled to confidential treatment. As a result of these determinations, information in these categories is not subject to the case-by-case or class determination processes under 40 CFR part 2 that EPA typically uses to evaluate whether such information qualifies for confidential treatment. Where we codify a determination that information is emission data or otherwise not entitled to confidential treatment, it will be subject to disclosure to the public without further notice. Any determination that applies for submitted information continues to apply even if that information is carried into other documents that EPA prepares for internal review or publication. EPA also notes that we are not making confidentiality determinations in this rulemaking for certain other identified information submitted to us for certification and compliance, which will remain subject to the case-by-case or class determination process under 40 CFR part 2, as established in this rulemaking under 40 CFR 2.301(j)(4).

<sup>526</sup> Nonroad applications include marine engines, locomotives, and a wide range of other land-based vehicles and equipment. Standards and certification requirements also apply for portable fuel containers and for fuel tanks and fuel lines used with some types of nonroad equipment. Standards and certification requirements also apply for stationary engines and equipment, such as generators and pumps. EPA also has emission standards for aircraft and aircraft engines. This preamble refers to all these different regulated products as "sources."

<sup>527</sup> 40 CFR parts 59, 60, 85, 86, 87, 1068, 1030, 1031, 1033, 1036, 1037, 1039, 1042, 1043, 1045, 1048, 1051, 1054, and 1060. These parts are hereinafter collectively referred to as "the standard-setting parts."

<sup>528</sup> We also receive numerous FOIA requests for information once enforcement actions have concluded. In responding to those requests, to the extent the information collected through the enforcement action corresponds to a category of certification or compliance information that we have determined to be emission data or otherwise not entitled to confidential treatment in this rulemaking, this final rule establishes that such information is also subject to the same categorical confidentiality determinations specified in 40 CFR 1068.11.

The CAA states that “[a]ny records, reports or information obtained under [section 114 and parts B and C of Subchapter II] shall be available to the public. . . .”<sup>529</sup> Thus, the CAA begins with a presumption that the information submitted to EPA will be available to be disclosed to the public.<sup>530</sup> It then provides a narrow exception to that presumption for information that “would divulge methods or processes entitled to protection as trade secrets. . . .”<sup>531</sup> The CAA then narrows this exception further by excluding “emission data” from the category of information eligible for confidential treatment. While the CAA does not define “emission data,” EPA has done so by regulation at 40 CFR 2.301(a)(2)(i). EPA releases, on occasion, some of the information submitted under CAA sections 114 and 208 to parties outside of the Agency of its own volition, through responses to requests submitted under the Freedom of Information Act (“FOIA”),<sup>532</sup> or through civil litigation. Typically, manufacturers may claim some of the information they submit to EPA is entitled to confidential treatment as confidential business information (“CBI”), which is exempt from disclosure under Exemption 4 of the FOIA.<sup>533</sup> Generally, when we have information that we intend to disclose publicly that is covered by a claim of confidentiality under FOIA Exemption 4, EPA has a process to make case-by-case or class determinations under 40 CFR part 2 to evaluate whether such information is or is not emission data, and whether it otherwise qualifies for confidential treatment under FOIA Exemption 4.<sup>534</sup>

This final rule adopts provisions regarding the confidentiality of certification and compliance information that is submitted by manufacturers to EPA for a wide range of engines, vehicles, and equipment that are subject to emission standards and other requirements under the CAA. This includes motor vehicles and motor vehicle engines, nonroad engines and nonroad equipment, aircraft and aircraft engines, and stationary engines. It also includes portable fuel containers regulated under 40 CFR part 59, subpart F, and fuel tanks, fuel lines, and related fuel system components regulated under 40 CFR part 1060. The regulatory

provisions regarding confidentiality determinations for these products are being codified broadly in 40 CFR 1068.11, with additional detailed provisions for specific sectors in the regulatory parts referenced in 40 CFR 1068.1. With this notice-and-comment rulemaking, EPA is making categorical emission data and confidentiality determinations that will apply to certain information collected by EPA for engine, vehicle, and equipment certification and compliance, including information collected during certain enforcement actions.<sup>535</sup>

At this time, EPA is not determining that any specific information *is* CBI or entitled to confidential treatment. EPA is instead identifying categories of information that are not appropriate for such treatment. We are maintaining the 40 CFR part 2 process for any information we are not determining to be emission data or otherwise not entitled to confidential treatment in this rulemaking. As explained further in the following discussion, the emission data and confidentiality determinations in this action are intended to increase the efficiency with which the Agency responds to FOIA requests and to provide consistency in the treatment of the same or similar information collected under the standard-setting parts. Establishing these determinations through this rulemaking will provide predictability for both information requesters and submitters. The emission data and confidentiality determinations in this final rule will also increase transparency in the certification programs.

After consideration of comments, we are revising the regulation from that proposed in the final rule to clarify that information submitted in support of a request for an exemption from emission standards and certification requirements will be subject to the 40 CFR part 2 process unless information from such a request is specifically identified as emission data in 40 CFR 1068.11. For example, emission test results used to demonstrate that engines meet a certain level of emission control that is required as a condition of a hardship exemption would not be entitled to confidential treatment, while other information not identified as emission data in 40 CFR 1068.11 would be subject to the 40 CFR part 2 process for making confidentiality determinations. These provisions apply equally for exemptions identified in 40

CFR part 1068, subpart C or D, or in the standard-setting parts.

In 2013 EPA published CBI class determinations for information related to certification of engines and vehicles under the standard-setting parts.<sup>536</sup> These determinations established whether those particular classes of information were releasable or entitled to confidential treatment and were instructive when making case-by-case determinations for other similar information within the framework of the CAA and the regulations. However, the determinations did not resolve all confidentiality questions regarding information submitted to the Agency for the standard-setting parts, and EPA receives numerous requests each year to disclose information that is not within the scope of these 2013 CBI class determinations.

Prior to this rulemaking, the Agency has followed the existing process in 40 CFR part 2 when making case-by-case or class confidentiality determinations. The part 2 confidentiality determination process is time consuming for information requesters, information submitters, and EPA. The determinations in this rulemaking will allow EPA to process requests for information more quickly, as the Agency will not always need to go through the part 2 process to make case-by-case determinations. Additionally, the determinations in this rulemaking will also provide predictability and consistency to information submitters on how EPA will treat the information. Finally, the part 2 confidentiality determination process is very resource-intensive for EPA, as it requires personnel in the program office to draft letters to the manufacturers (of which there may be many) requesting that they substantiate their claims of confidentiality, review each manufacturer’s substantiation response, and prepare a recommendation for the Office of General Counsel. The Office of General Counsel then must review the recommendation and all the materials to issue a final determination on the entitlement of the information to confidential treatment. For these reasons, we are amending our regulations in 40 CFR parts 2 and 1068 to establish a broadly applicable set of confidentiality determinations for categories of information, through this rulemaking. This final action supersedes

<sup>529</sup> CAA section 114(c) and 208(c); 42 U.S.C. 7414(c) and 7542(c).

<sup>530</sup> CAA section 114(c) and 208(c); 42 U.S.C. 7414(c) and 7542(c).

<sup>531</sup> CAA section 114(c) and 208(c); 42 U.S.C. 7414(c) and 7542(c).

<sup>532</sup> 5 U.S.C. 552.

<sup>533</sup> 5 U.S.C. 552(b)(4).

<sup>534</sup> 40 CFR 2.205.

<sup>535</sup> Throughout this preamble, we refer to certification and compliance information. Hereinafter, the enforcement information covered by the confidentiality determination in this final rule is included when we refer to certification and compliance information.

<sup>536</sup> EPA, Class Determination 1–13, Confidentiality of Business Information Submitted in Certification Applications for 2013 and subsequent model year Vehicles, Engines and Equipment, March 28, 2013, available at [https://www.epa.gov/sites/default/files/2020-02/documents/1-2013\\_class\\_determination.pdf](https://www.epa.gov/sites/default/files/2020-02/documents/1-2013_class_determination.pdf).

the class determinations made in 2013.<sup>537</sup>

In this action, EPA is finalizing regulations to establish categories for certain certification and compliance information submitted under the standard-setting parts and determining that certain categories of certification and compliance information are not entitled to confidential treatment, including revisions to 40 CFR parts 2, 59, 60, 85, 86, 87, 1030, 1031, 1033, 1036, 1037, 1043, 1045, 1048, 1051, 1054, 1060, and 1068. The confidentiality determinations for these categories, and the basis for such determinations, are described in the following discussion. Additionally, a detailed description of the specific information submitted under the standard-setting parts that currently falls within these categories is also available in the docket for this rulemaking.<sup>538</sup> The determinations made in this rulemaking will serve as notification of the Agency's decisions on: (1) The categories of information the Agency will not treat as confidential; and (2) the categories of information that may be claimed as confidential but will remain subject to the existing part 2 process. We are not making in this rule a determination in favor of confidential treatment for any information collected for certification and compliance of engines, vehicles, equipment, and products subject to evaporative emission standards. In responding to requests for information not determined in this rule to be emission data or otherwise not entitled to confidential treatment, we will continue to apply the existing case-by-case process governed by 40 CFR part 2.

We are also establishing provisions in the Agency's Clean Air Act-specific FOIA regulations at 40 CFR 2.301(j)(2) and (4) concerning information determined to be entitled to confidential treatment through rulemaking in 40 CFR part 1068. These provisions are very similar to the regulations established by

<sup>537</sup> We intend for this rulemaking to be consistent with Tables 1 and 2 from the 2013 class determinations. Specifically, the CBI class determinations reflected in Table 1 and Table 2 of the 2013 determination are consistent with the determinations described in Section XI.A.1.i. and Section XI.A.1.iii, respectively. However, for the reasons described in Section XI.A.1.iv, the information in Table 3 of the 2013 determination will be subject to the existing part 2 process, such that EPA will continue to make case-by-case CBI determinations as described in Section XI.A.1.iv.

<sup>538</sup> See Zaremski, Sara. Memorandum to docket EPA-HQ-OAR-2019-0055. "Supplemental Information for CBI Categories for All Industries and All Programs". October 1, 2021, and attachment "CBI Categories for All Industries All Programs" (hereinafter "CBI Chart"), available in the docket for this action.

the Greenhouse Gas Reporting Program from 40 CFR part 98 that is addressed at 40 CFR 2.301(d). The regulation at 40 CFR 2.301(j)(4)(ii) addresses the Agency's process for reconsidering a determination that information is entitled to confidential treatment under 40 CFR 2.204(d)(2) if there is a change in circumstance in the future. This provision is intended to maintain flexibility the Agency currently has under its part 2 regulations. Note that because this rulemaking is not determining that any information is entitled to confidential treatment, these regulations at 40 CFR 2.301(j)(2) and (4) do not apply to any confidentiality determination made by this rulemaking.

The information categories established in this final action are:

- (1) Certification and compliance information,
- (2) fleet value information,
- (3) source family information,
- (4) test information and results,
- (5) averaging, banking, and trading ("ABT") credit information,
- (6) production volume information,
- (7) defect and recall information, and
- (8) selective enforcement audit ("SEA") compliance information.

The information submitted to EPA under the standard-setting parts can be grouped in these categories based on their shared characteristics. That said, much of the information submitted under the standard-setting parts could be logically grouped into more than one category. For the sake of organization, we have chosen to label information as being in just one category where we think it fits best. We believe this approach will promote greater accessibility to the CBI determinations, reduce redundancy within the categories that could lead to confusion, and ensure consistency in the treatment of similar information in the future. We received supporting comment on the following: (1) Our proposed categories of information; (2) the proposed confidentiality determination on each category; and (3) our placement of each data point under the category proposed. None of the comments we received on the proposed emission data determinations disputed EPA's conclusion that the information specified in those determinations is emission data. We have responded to these comments in the Response to Comments.

i. Information that is emission data and therefore not entitled to confidential treatment.

We are applying the regulatory definition of "emission data" in 40 CFR 2.301(a)(2)(i) to determine that certain categories of source certification and

compliance information are not entitled to confidential treatment. As relevant here, a source is generally the engine, vehicle, or equipment covered by a certificate of conformity. Alternatively, a source is each individual engine, vehicle, or equipment produced under a certificate of conformity. CAA sections 114 and 208 provide that certain information submitted to EPA may be entitled to confidential treatment. However, section 114 also expressly excludes emission data from that category of information. The CAA does not define "emission data," but EPA has done so by regulation in 40 CFR 2.301(a)(2)(i).

EPA's regulations broadly define emission data as information that falls into one or more of three types of information. Specifically, emission data is defined in 40 CFR 2.301(a)(2)(i), for any source of emission of any substance into the air as:

- Information necessary to determine the identity, amount, frequency, concentration, or other characteristics (to the extent related to air quality) of any emission which has been emitted by the source (or of any pollutant resulting from any emission by the source), or any combination of the foregoing;

- Information necessary to determine the identity, amount, frequency, concentration, or other characteristics (to the extent related to air quality) of the emissions which, under an applicable standard or limitation, the source was authorized to emit (including, to the extent necessary for such purposes, a description of the manner or rate of operation of the source); and

- A general description of the location and/or nature of the source to the extent necessary to identify the source and to distinguish it from other sources (including, to the extent necessary for such purposes, a description of the device, installation, or operation constituting the source).

EPA's broad general definitions of emissions data also exclude certain information related to products still in the research and development phase or products not yet on the market except for limited purposes. Thus, for example, 40 CFR 2.301(a)(2)(ii) excludes information related to "any product, method, device, or installation (or any component thereof) designed and intended to be marketed or used commercially but not yet so marketed or used." This specific exclusion from the definition of emissions data is limited in time.

Consistent with this limitation, and as described in Sections XI.A.1.i and iii, in this rulemaking we are maintaining

confidential treatment prior to the introduction-into-commerce date for the information included in an application for certification. Though the nature of this information would otherwise make it emissions data, it is not emissions data for purposes of this regulatory definition and thus subject to release, until the product related to the information has been introduced into commerce, consistent with 40 CFR 2.301(a)(2)(ii). The introduction-to-commerce date is generally specified in an application for certification, even in cases where it is not required. After consideration of comments, we are clarifying from the proposal in the final rule that when an application for certification does not specify an introduction into commerce date or in situations where a certificate of conformity is issued after the introduction-into-commerce date, EPA will use the date of certificate issuance, as stated in the final 40 CFR 1068.10(d)(1).

We are establishing in 40 CFR 1068.11(a) that certain categories of information the Agency collects in connection with the Title II programs are information that meet the regulatory definition of emission data under 40 CFR 2.301(a)(2)(i). The following sections describe the categories of information we have determined to be emission data, based on application of the definition at 40 CFR 2.301(a)(2)(i) to the shared characteristics of the information in each category and our rationale for each determination. The CBI Chart in the docket provides a comprehensive list of the current regulatory citations under which we collect the information that we have grouped into each category and can be found in the docket for this action. For ease of reference, we have also indicated in the CBI Chart the reason(s) explained in Sections XI.A.1 and 3 of this action for why EPA has determined that the information submitted is not entitled to confidential treatment. The CBI Chart provides the information EPA currently collects that is covered by the determinations in this rulemaking, the regulatory citation the information is collected under, the information category for the information, the confidentiality determination for the information, and the rationale EPA used to determine whether the information is not entitled to confidential treatment (*i.e.*, the information qualifies as emission data under one or more subparagraphs of the regulatory definition of emission data, is both emission data and publicly available after the introduction-into-commerce-

date, etc.). Much of the information covered by these determinations are emission data under more than one basis under the regulatory definition of emission data, as described at the end of each of the sections that follow. For each category of information and each data point we have determined belongs in each category, each basis independently is an alternative argument supporting EPA's final determinations.

ii. Information necessary to determine the identity, amount, frequency, concentration, or other characteristics (to the extent related to air quality) of any emission which has been emitted by the source (or of any pollutant resulting from any emission by the source), or any combination of the foregoing.

We are finalizing the proposed determination that the categories of information identified meet the regulatory definition of emission data under 40 CFR 2.301(a)(2)(i)(A), which defines emission data to include “[i]nformation necessary to determine the identity, amount, frequency, concentration, or other characteristics (to the extent related to air quality) of any emission which has been emitted by the source (or of any pollutant resulting from any emission by the source), or any combination of the foregoing[.]”<sup>539</sup> For shorthand convenience, we refer to information that qualifies as emission data under subparagraph (A) in the definition of emission data as merely “paragraph A information.”

EPA collects emission information during certification, compliance reporting, SEAs, defect and recall reporting, in ABT programs, and in various testing programs like production line testing (“PLT”) and in-use testing. The following categories of information are emission data under 40 CFR 2.301(a)(2)(i)(A):

- (1) Fleet value information,
- (2) test information and results (including certification testing, PLT, in-use testing, fuel economy testing, and SEA testing),
- (3) ABT credit information,
- (4) production volume,
- (5) defect and recall information, and
- (6) SEA compliance information.

All these categories include information that also fits under the other emission data regulatory definition subparagraphs, therefore, the lists in this section are not exhaustive of the information in each category. The 40 CFR 2.301(a)(2)(i)(A) information we identify in this section under each of the categories is also emission data under paragraph (a)(2)(i)(B) of the definition of

emission data and may also be emission data under paragraph (a)(2)(i)(C) of the definition of emission data. In the CBI Chart in the docket, we have identified for every piece of information in every category all the applicable emission data definition subparagraphs. Nevertheless, in this action, we have chosen to explain each piece of information in detail only under the most readily applicable subparagraph of emission data, while highlighting that the information could also qualify as emission data under another subparagraph of the regulatory definition of emission data. Consistent with 40 CFR 2.301(a)(2)(ii), under this determination, we will not release information included in an application for certification prior to the introduction-into-commerce-date, except under the limited circumstances already provided for in that regulatory provision.

*Fleet Value Information:* The fleet value information category includes the following information that underlies the ABT compliance demonstrations and fleet average compliance information for on-highway and nonroad:

- (1) Offsets,
- (2) displacement,
- (3) useful life,
- (4) power payload tons,
- (5) load factor,
- (6) integrated cycle work,
- (7) cycle conversion factor, and
- (8) test cycle.

The information in this category underlies the fleet average calculations, which are necessary to understand the type and amount of emissions released in-use from sources regulated under the standard-setting parts that require a fleet average compliance value. These values represent compounds emitted, though the raw emissions from an individual source may be different from these values due to other variables in the fleet value calculation. For these reasons, we determine the fleet value information category is emission data because it is necessary to identify and determine the amount of emissions emitted by sources.<sup>540</sup> Note, we are also determining that a portion of the fleet value information category meets another basis in the emission data definition in 40 CFR 2.301(a)(2)(i), as discussed in more detail in Section XI.A.1.i.b, because it is “[i]nformation necessary to determine the identity, amount, frequency, concentration, or other characteristics (to the extent related to air quality) of the emissions which, under an applicable standard or limitation, the source was authorized to

<sup>539</sup> 40 CFR 2.301(a)(2)(i)(A).

<sup>540</sup> *Id.*

emit (including, to the extent necessary for such purposes, a description of the manner or rate of operation of the source)[.]”<sup>541</sup>

*Test Information and Results:* The test information and results category includes information collected during the certification process, PLT testing, in-use testing programs, testing to determine fuel economy, and testing performed during an SEA. This category encompasses the actual test results themselves and information necessary to understand how the test was conducted, and other information to fully understand the results. We are including in the test information and results category the certification test results information, including emission test results which are required under the standard-setting parts. Before introducing a source into commerce, manufacturers must certify that the source meets the applicable emission standards and emissions related requirements. To do this, manufacturers conduct specified testing during the useful life of a source and submit information related to those tests. Emission test results are a straightforward example of emission data, as they identify and measure the compounds emitted from the source during the test. Furthermore, the tests were designed and are performed for the explicit purpose of determining the identity, amount, frequency, concentration, or other air quality characteristics of emissions from a source. For these reasons, we are determining that test information and results category is emission data because it is necessary to determine the emissions emitted by a source.<sup>542</sup> We are also determining that all the information in the test information and results category, except fuel economy label information, is emissions data under another subsection of the regulatory definition of emissions data it is “[i]nformation necessary to determine the identity, amount, frequency, concentration, or other characteristics (to the extent related to air quality) of the emissions which, under an applicable standard or limitation, the source was authorized to emit (including, to the extent necessary for such purposes, a description of the manner or rate of operation of the source)[.]”<sup>543</sup> See Section XI.A.1.i.b for a more detailed discussion for issues related to test information and results. See Section XI.A.1.iii for additional

discussion of fuel economy label information.

EPA collects the following test information and results from the PLT program. For CI engines and vehicles these include: CO results, particulate matter (PM) results, NO<sub>x</sub> results, NO<sub>x</sub> + HC results, and HC results. For SI engines and vehicles and for products subject to the evaporative emission standards these include: Fuel type used, number of test periods, actual production per test period, adjustments, modifications, maintenance, test number, test duration, test date, end test period date, service hours accumulated, test cycle, number of failed engines, initial test results, final test results, and cumulative summation. Manufacturer-run production-line testing is conducted under the standard-setting parts to ensure that the sources produced conform to the certificate issued. PLT results are emission test results and, for that reason, are among the most straightforward examples of emission data, as they identify and measure the compounds emitted from the source during the test. For example, the measured amounts of specified compounds (like HC results, CO results, and PM results) are measured emissions, i.e. the factual results of testing. Similarly, the number of failed engines is emission data as it reflects the results of emissions testing. Additionally, adjustments, modifications, maintenance, and service hours accumulated are information necessary for understanding the test results. We determine that the categories of information listed in this paragraph is necessary to understand the context and conditions in which the test was performed, like test number, test duration, test date, number of test periods, actual production per test period, end test period, and is, therefore, emission data because it is information necessary for understanding the characteristics of the test as performed, the test results, and the information that goes into the emissions calculations. Furthermore, PLT is performed for the explicit purpose of determining the identity, amount, frequency, concentration, or other air quality characteristics of emissions from a source. For these reasons, we determine that test information and results category is emission data because it is necessary to determine the emissions emitted by a source.<sup>544</sup> Note, we are also determining that the PLT information in the test information and results category is emissions data under another subsection of the regulatory

definition of emissions data, as discussed in more detail in Section XI.A.1.i.b, as it additionally provides “[i]nformation necessary to determine the identity, amount, frequency, concentration, or other characteristics (to the extent related to air quality) of the emissions which, under an applicable standard or limitation, the source was authorized to emit (including, to the extent necessary for such purposes, a description of the manner or rate of operation of the source)[.]”<sup>545</sup>

The test information and results category also includes the following information from the in-use testing program: A description of how the manufacturer recruited vehicles, the criteria use to recruit vehicles, the rejected vehicles and the reason they were rejected, test number, test date and time, test duration and shift-days of testing, weather conditions during testing (ambient temperature and humidity, atmospheric pressure, and dewpoint), differential back pressure, results from all emissions testing, total hydrocarbons (HC), NMHC, carbon monoxide, carbon dioxide, oxygen, NO<sub>x</sub>, PM, and methane, applicable test phase (Phase 1 or Phase 2), adjustments, modifications, repairs, maintenance history, vehicle mileage at start of test, fuel test results, total lifetime operating hours, total non-idle operation hours, a description of vehicle operation during testing, number of valid Not to Exceed (NTE) events, exhaust flow measurements, recorded one-hertz test data, number of engines passed, vehicle pass ratio, number of engines failed, outcome of Phase 1 testing, testing to determine why a source failed, the number of incomplete or invalid tests, usage hours and use history, vehicle on board diagnostic (“OBD”) system history, engine diagnostic system, number of disqualified engines, and number of invalid tests. The in-use testing information includes actual test results and the information that goes into the emissions calculations. For example, the measured amounts of specified compounds (like total HC) are measured emissions, and adjustments, modifications, and repairs are information necessary for understanding the test results. It is necessary to know if and how a source has changed from its certified condition during its use, as these changes may impact the source’s emissions. Total lifetime operating hours and usage hours information is also used to calculate emissions during in-use testing. The diagnostic system information is necessary for

<sup>541</sup> 40 CFR 2.301(a)(2)(i)(B).

<sup>542</sup> 40 CFR 2.301(a)(2)(i)(A).

<sup>543</sup> 40 CFR 2.301(a)(2)(i)(B).

<sup>544</sup> 40 CFR 2.301(a)(2)(i)(A).

<sup>545</sup> 40 CFR 2.301(a)(2)(i)(B).

understanding emissions, as well, because it provides context to and explains the test results; if an issue or question arises from the in-use testing, the diagnostic system information allows for greater understanding of the emissions performance. Additionally, the number of disqualified engines is necessary to determine the sources tested, if an end user has modified the source such that it cannot be used for in-use testing, this directly relates to the sources eligible for in-use testing and the emission measurements resulting from those tests. For these reasons, we determine that the in-use testing information is emission data because it is necessary to determine the emissions emitted by sources.<sup>546</sup> Note, we are also determining that the in-use testing information is emissions data under another subsection of the regulatory definition of emissions data, as discussed in more detail in Section XI.A.1.i.b, as it additionally provides “[i]nformation necessary to determine the identity, amount, frequency, concentration, or other characteristics (to the extent related to air quality) of the emissions which, under an applicable standard or limitation, the source was authorized to emit (including, to the extent necessary for such purposes, a description of the manner or rate of operation of the source).]”<sup>547</sup>

We are also determining that the test information and results category include the underlying information necessary to determine the adjusted and rounded fuel economy label values and the resulting label values. The underlying information includes test result values that are plugged into a calculation included in the standard-setting parts that establish the fuel economy rating. These results represent emissions, the rate at which they are released, and are necessary to understanding the fuel economy rating. For these reasons, the fuel economy label information is appropriately included in the test information and results category. Accordingly, we determine that fuel economy label information is emission data because it is necessary to determine the emissions emitted by sources.<sup>548</sup> Note, also, that a portion of the fuel economy label information is not entitled to confidential treatment because it is required to be publicly available and is discussed in more detail in Section XI.A.1.iii. We are, in this rulemaking, superseding the 2013 class determination Table 3 for all fuel

economy label information, but the determination here applies only to a portion of the fuel economy label information, as explained in Section XI.A.1.iv.

We are determining that the test information and results category include the following information from SEA testing: The test procedure, initial test results, rounded test results, final test results, final deteriorated test results, the number of valid tests conducted, the number of invalid tests conducted, adjustments, modifications, repairs, test article preparation, test article maintenance, and the number of failed engines and vehicles. SEAs can be required of manufacturers that obtain certificates of conformity for their engines, vehicles, and equipment. SEA test information includes emission test results from tests performed on production engines and equipment covered by a certificate of conformity. These tests measure the emissions emitted from the test articles; therefore, they are emission data and not entitled to confidentiality. The information supporting the test results, such as the number of valid tests conducted, the adjustments, modifications, repairs, and maintenance regarding the test article, is necessary to understand the test results and is, therefore, also emission data. For these reasons, we also determine that SEA test information is appropriately grouped in test information and results category and is emission data because it is necessary to identify and determine the amount of emissions from a source.<sup>549</sup> The SEA test information, like all the information in the test information and results category, is emissions data under another subsection of the regulatory definition of emissions data, as discussed in more detail in Section XI.A.1.i.b, as it provides “[i]nformation necessary to determine the identity, amount, frequency, concentration, or other characteristics (to the extent related to air quality) of the emissions which, under an applicable standard or limitation, the source was authorized to emit (including, to the extent necessary for such purposes, a description of the manner or rate of operation of the source).]”<sup>550</sup>

*Production Volume:* We are determining that the production volume category is emission data and is not entitled to confidential treatment because the information is necessary to determine the total emissions emitted by the source, where the source is the type of engine, vehicle, or equipment

covered by a certificate of conformity. The certificate of conformity for a source does not, on its face, provide aggregate emissions information for all the sources covered by that certificate. Rather, it provides information relative to each single unit of the source covered by a certificate. The production volume is necessary to understand the amount, frequency, and concentration of emissions emitted from the aggregate of units covered by a single certificate that comprise the source. In other words, unless there will only ever be one single engine, vehicle, or equipment covered by the certificate of conformity, the emissions from that source will not be expressed by the certificate and compliance information alone. The total number of engines, vehicles, or equipment produced, in combination with the certificate information, is necessary to know the real-world impact on emissions from that source. Additionally, the production volume is also collected for the purpose of emission modeling. For example, engine population (the number of engines in use) is used in the non-road emissions model to establish emission standards. Production volume, when used in combination with the other emission data we collect (certification test results, in-use test results, defects and recalls, etc.), also allows EPA and independent third parties to calculate total mobile source air emissions. For these reasons, production volume is “necessary to determine the identity, amount, frequency, concentration, or other characteristics (to the extent related to air quality) of any emission which has been emitted by the source (or of any pollutant resulting from any emission by the source), or any combination of the foregoing[.]”<sup>551</sup> Note also that the production volume category is emissions data under another subsection of the regulatory definition of emissions data, as discussed in more detail in Section XI.A.1.i.c, as it additionally provides “[a] general description of the location and/or nature of the source to the extent necessary to identify the source and to distinguish it from other sources (including, to the extent necessary for such purposes, a description of the device, installation, or operation constituting the source).”<sup>552</sup>

*Defect and Recall Information:* We are determining that the defect and recall information category is emission data and not entitled to confidential treatment because it is information necessary to determine the emissions from a source that has been issued a

<sup>546</sup> 40 CFR 2.301(a)(2)(i)(A).

<sup>547</sup> 40 CFR 2.301(a)(2)(i)(B).

<sup>548</sup> 40 CFR 2.301(a)(2)(i)(A).

<sup>549</sup> *Id.*

<sup>550</sup> 40 CFR 2.301(a)(2)(i)(B).

<sup>551</sup> 40 CFR 2.301(a)(2)(i)(A).

<sup>552</sup> 40 CFR 2.301(a)(2)(i)(C).

certificate of conformity.<sup>553</sup> The only defects and recalls that manufacturers or certificate holders are required to report to EPA are ones that impact emissions or could impact emissions. Therefore, if a defect or recall is reported to us, it is because it causes or may cause increased emissions and information relating to that defect or recall is necessarily emission data, as it directly relates to the source's emissions. The defect and recall information category includes any reported emission data available. This information is the available test results that a manufacturer has after conducting emission testing, and an estimate of the defect's impact on emissions, with an explanation of how the manufacturer calculated this estimate and a summary of any available emission data demonstrating the impact of the defect. Note, we are only determining that a portion of the defect and recall information category is paragraph A information. As discussed in Section XI.A.1.iv, we are not making a confidentiality determination on the defect investigation report at this time. We are also determining that the information in this category, excluding the defect investigation report, is emissions data under another subsection of the regulatory definition of emissions data, as discussed in more detail in Section XI.A.1.i.b, as it additionally provides "[i]nformation necessary to determine the identity, amount, frequency, concentration, or other characteristics (to the extent related to air quality) of the emissions which, under an applicable standard or limitation, the source was authorized to emit (including, to the extent necessary for such purposes, a description of the manner or rate of operation of the source)[.]"<sup>554</sup>

As noted throughout this section, the information included in the categories identified as paragraph A information also meet another prong of the definition of emission data.<sup>555</sup> See Section XI.A.1.i.b for our discussion of why this information is also emission data as defined at 40 CFR 2.301(a)(2)(i)(B). See Section XI.A.1.i.c for our discussion of why this information is also emission data as defined at 40 CFR 2.301(a)(2)(i)(C).

iii. Information necessary to determine the identity, amount, frequency, concentration, or other characteristics (to the extent related to air quality) of the emissions which, under an applicable standard or limitation, the source was authorized to

emit (including, to the extent necessary for such purposes, a description of the manner or rate of operation of the source).

We are determining that information within the categories explained in this subsection meets the regulatory definition of emission data under 40 CFR 2.301(a)(2)(i)(B) because it is "[i]nformation necessary to determine the identity, amount, frequency, concentration, or other characteristics (to the extent related to air quality) of the emissions which, under an applicable standard or limitation, the source was authorized to emit (including, to the extent necessary for such purposes, a description of the manner or rate of operation of the source)[.]" We will refer to subparagraph (B) in the definition of emission data as "paragraph B information" throughout this section.

The vast majority of the information we collect for certification and compliance fits within this subparagraph of the definition of emission data. We determine that the following categories are paragraph B information and not entitled to confidential treatment:

- (1) Certification and compliance information,
- (2) ABT credit information,
- (3) fleet value information,
- (4) production volumes,
- (5) test information and results,
- (6) defect and recall information, and
- (7) SEA compliance information.

These categories are summarized here and described in more detail in the following discussion. Certification and compliance information category includes information that is submitted in manufacturers' certificate of conformity applications and information reported after the certificate is issued to ensure compliance with both the certificate and the applicable standards, which is required under EPA's regulation. ABT credit information shows whether a manufacturer participating in an ABT program has complied with the applicable regulatory standards. Additionally, fleet value information is collected by EPA to calculate average and total emissions for a fleet of sources, thereby demonstrating compliance with the applicable regulatory standards when a manufacturer participates in an ABT program or for fleet averaging programs. A portion of the test and test result category of information is distinguishable under the paragraph A information basis. This portion of the test information and results category includes information that explains how the tests and test results demonstrate

compliance with the applicable standards and is identified and discussed in this section. The test information and results described in Section XI.A.1.i.a is also necessary to understand whether a source complies with the applicable standard-setting parts. The SEA compliance information category includes information related to understanding how the results of the SEA reflect whether a source complies with the applicable standard-setting parts. Consistent with 40 CFR 2.301(a)(2)(ii), under this determination, we will not release information included in an application for certification prior to the introduction-into-commerce-date, except under the limited circumstances already provided for in that regulatory provision.

These categories apply to information submitted for certification and compliance reporting across the standard-setting parts. These categories make up the largest amount of information addressed by the confidentiality determinations.

*Certification and Compliance Information:* Once EPA certifies a source as conforming to applicable emission standards (*i.e.*, the source has a certificate of conformity), all sources the manufacturer produces under that certificate must conform to the requirements of the certificate for the useful life of the source. In short, a source's compliance is demonstrated against the applicable certificate of conformity through inspection and testing conducted by EPA and the manufacturers. Therefore, certification and compliance information falls under subparagraph B of emission data because it is "necessary to determine the identity, amount, frequency, concentration, or other characteristic (to the extent related to air quality) of the emissions which, under an applicable standard or limitation, the source was authorized to emit (including, to the extent necessary for such purposes, a description of the manner or rate of operation of the source)[.]"<sup>556</sup> The certification and compliance information category includes models and parts information, family determinants, general emission control system information, and certificate request information (date, requester, etc.), contact names, importers, agents of service, and ports of entry used. The models and parts information is necessary to determine that the sources actually manufactured conform to the specifications of the certificate. Lastly, certificate request information is general information necessary to identify the

<sup>553</sup> 40 CFR 2.301(a)(2)(i)(A).

<sup>554</sup> 40 CFR 2.301(a)(2)(i)(B) and (C).

<sup>555</sup> 40 CFR 2.301(a)(2)(i)(B).

<sup>556</sup> *Id.*

applicable certificate of conformity for a source, as well as understanding the timing and processing of the request. For these reasons, we are determining certificate information is emission data because it is necessary to determine whether a source has achieved compliance with the applicable standards.<sup>557</sup> Note, also, that a portion of the category of certification and compliance information meets another basis in the emission data definition, as discussed in more detail in Section XI.A.1.i.c, as it additionally provides “[a] general description of the location and/or nature of the source to the extent necessary to identify the source and to distinguish it from other sources (including, to the extent necessary for such purposes, a description of the device, installation, or operation constituting the source).”<sup>558</sup>

**ABT Credit Information:** ABT programs are an option for compliance with certain emissions standards. In ABT programs, manufacturers may generate credits when they certify that their vehicles, engines, and equipment achieve greater emission reductions than the applicable standards require. “Averaging” within ABT programs means exchanging emission credits between vehicle or engine families within a given manufacturer’s regulatory subcategories and averaging sets. This can allow a manufacturer to certify one or more vehicle or engine families within the same averaging set at levels higher than the applicable numerical emission standard under certain regulatory conditions. The increased emissions over the otherwise applicable standard would need to be offset by one or more vehicle or engine families within that manufacturer’s averaging set that are certified lower than the same emission numerical standard, such that the average emissions from all the manufacturer’s vehicle or engine families, weighted by engine power, regulatory useful life, and production volume, are at or below the numerical level required by the applicable standards. “Banking” means the retention of emission credits by the manufacturer for use in future model year averaging or trading. “Trading” means the exchange of emission credits between manufacturers, which can then be used for averaging purposes, banked for future use, or traded again to another manufacturer. The ABT credit information category includes a manufacturer’s banked credits, transferred credits, traded credits, total credits, credit balance, and annual

credit balance. Because manufacturers participating in ABT programs use credits to demonstrate compliance with the applicable standards, ABT information is “necessary to determine the identity, amount, frequency, concentration, or other characteristic (to the extent related to air quality) of the emissions which, under an applicable standard or limitation, the source was authorized to emit (including, to the extent necessary for such purposes, a description of the manner or rate of operation of the source)[.]”<sup>559</sup> For these reasons, we determine ABT credit information is emission data because it is necessary to determine whether a source has achieved compliance with the applicable standards.<sup>560</sup>

**Fleet Value Information:** ABT credit information must be reviewed by EPA in conjunction with the fleet value information, which underlies a manufacturer’s credit balance. The two categories are distinct from each other, though the information under the two categories is closely related. In addition to reasons described in Section XI.A.1.i.a, manufacturers submit fleet value information also used for compliance reporting under ABT programs, though some fleet value information is collected during certification for the on-highway sectors. The fleet value information category includes: Source classification, averaging set, engine type or category, conversion factor, engine power, payload tons, intended application, advanced technology (“AT”) indicator, AT CO<sub>2</sub> emission, AT improvement factor, AT CO<sub>2</sub> benefit, innovative technology (“IT”) indicator, IT approval code, and IT CO<sub>2</sub> improvement factor. Additionally, the fleet value information category includes the following for light-duty vehicles and engines, non-road SI engines, and products subject to evaporative emission standards: Total area of the internal surface of a fuel tank, adjustment factor, and deterioration factor. Fleet value information is used in ABT programs to explain and support a manufacturer’s ABT credit balance. For the standard-setting parts that require a fleet average compliance value, the fleet value information is used to demonstrate compliance with the applicable standard setting parts. For these reasons, we are determining that the fleet value information category is emission data because it is information necessary to understand the ABT compliance demonstration and compliance with the

fleet average value, as applicable.<sup>561</sup> Additionally, a portion of the fleet value information is emission data, as described in Section XI.A.1.i.a, because it is “necessary to determine the identity, amount, frequency, concentration, or other characteristics (to the extent related to air quality) of any emission which has been emitted by the source (or of any pollutant resulting from any emission by the source), or any combination of the foregoing[.]”<sup>562</sup>

**Production Volumes:** The production volume category is emission data because it is necessary to determine compliance with the standards when a manufacturer meets requirements in an ABT credit, PLT, or in-use testing program, and also for GHG fleet compliance assessment. When a manufacturer is subject to these programs, the production volume is necessary to determine whether that manufacturer has complied with the applicable standards and limitations. In ABT programs, the averages used to calculate credit balances are generated based on the production volumes of the various families certified. For GHG standards compliance, manufacturers generally comply based on their overall fleet average, therefore, the production volume is necessary to calculate the fleet average and whether the manufacturers’ fleet complies with the applicable standards. For these reasons, production volume information is necessary to understanding the calculations behind a manufacturer’s credit generation and use, as well as a manufacturer’s fleet average, which are then used to demonstrate compliance with the applicable standards.<sup>563</sup> Additionally, for PLT and in-use testing, production volumes are used to determine whether and how many sources are required to be tested or, in some cases, whether the testing program needs to be undertaken at all. In this way, production volume is tied to compliance with the PLT and in-use testing requirements and is paragraph B information necessary for demonstrating compliance with an applicable standard. Note, that the production volume category is emission data for multiple reasons, as discussed in Sections XI.A.1.i.a and XI.A.1.i.c.

**Test Information and Results:** The test information and results category includes the testing conducted by manufacturers and is necessary to demonstrate that the test parameters meet the requirements of the regulations. This ensures that the test

<sup>557</sup> *Id.*

<sup>558</sup> 40 CFR 2.301(a)(2)(i)(C).

<sup>559</sup> 40 CFR 2.301(a)(2)(i)(B).

<sup>560</sup> *Id.*

<sup>561</sup> *Id.*

<sup>562</sup> 40 CFR 2.301(a)(2)(i)(A).

<sup>563</sup> 40 CFR 2.301(a)(2)(i)(B).



results are reliable and consistent. If a test does not meet the requirements in the applicable regulations, then the results cannot be used for certification or compliance purposes. The parameters and underlying information of an emissions test is information necessary to understanding the test results themselves. Adjustable parameter information is necessary to understand the tests used to certify a source and, therefore, also necessary to understand the test results and whether the source achieved compliance with the applicable standard. For these reasons, we are determining that the test information and results category is “necessary to determine the identity, amount, frequency, concentration, or other characteristic (to the extent related to air quality) of the emissions which, under an applicable standard or limitation, the source was authorized to emit (including, to the extent necessary for such purposes, a description of the manner or rate of operation of the source[.]”<sup>564</sup> Test information and results collected under the standard-setting parts includes the following: Test temperature, adjustable test parameters, exhaust emission standards and family emission limits (FELs), emission deterioration factors, fuel type used, intended application, CO standard, particulate matter (“PM”) standard, NO<sub>x</sub> + HC standard, NO<sub>x</sub> standard, HC standard, CO<sub>2</sub> alternate standard, alternate standard approval code, CO<sub>2</sub> family emission limit (“FEL”), CO<sub>2</sub> family certification level (“FCL”), NO<sub>x</sub> and NMHC + NO<sub>x</sub> standard, NO<sub>x</sub> and NMHC + NO<sub>x</sub> alternate standard, N<sub>2</sub>O standard, N<sub>2</sub>O FEL, CH<sub>4</sub> standard, CH<sub>4</sub> FEL, NO<sub>x</sub> or NMHC + NO<sub>x</sub> FEL, PM FEL, test number, test time, engine configuration, green engine factor, the test article’s service hours, the deterioration factor type, test location, test facility, the manufacturer’s test contact, fuel test results, vehicle mileage at the start of the test, exhaust aftertreatment temperatures, engine speed, engine brake torque, engine coolant temperature, intake manifold temperature and pressure, throttle position, parameter sensed, emission-control system controlled, fuel-injection timing, NTE threshold, limited testing region, meets vehicle pass criteria (*i.e.*, whether the test passes the applicable emission standard), number of engines tested, number of engines still needing to be tested, number of engines passed, purpose of diagnostics, instances for OBD illuminated or set trouble codes, instance of misfuelling, incomplete or

invalid test information, the minimum tests required, diagnostic system, and the number of disqualified engines. For the reasons given, we are determining that test information and results is emission data because it is both necessary to understand how the source meets the applicable standards, including, but not limited to, ABT compliance demonstrations, and to ensure a source is complying with its certificate of conformity.<sup>565</sup> Additionally, a portion of the information included in the test information and results category is emissions data under another subsection of the regulatory definition of emissions data, as discussed in more detail in Section XI.A.1.i.a, as it is also “[i]nformation necessary to determine the identity, amount, frequency, concentration, or other characteristics (to the extent related to air quality) of any emission which has been emitted by the source (or of any pollutant resulting from any emission by the source), or any combination of the foregoing[.]”<sup>566</sup>

*Defect and Recall Information:* We are determining that the defect and recall information category is emission data and not entitled to confidential treatment because it is information necessary to determine compliance with an applicable standard or limitation.<sup>567</sup> The only defects and recalls that manufacturers are required to report to EPA are ones that impact emissions or could impact emissions. Therefore, if a defect is reported to us, it is because it causes or may cause increased emissions and information relating to that defect is necessarily emission data, as it directly relates to the source’s compliance with an applicable standard. The defect and recall information category, including information collected under the standard-setting parts, includes: System compliance reporting type, EPA compliance report name, manufacturer compliance report, manufacturer compliance report identifier, contact identifier, process code, submission status, EPA submission status and last modified date, submission creator, submission creation date, last modified date, last modified by, EPA compliance report identifier, compliance report type, defect category, defect description, defect emissions impact estimate, defect remediation plan explanation, drivability problems description, emission data available indicator, OBD MIL illumination indicator, defect identification source/method, plant

address where defects were manufactured, certified sales area, carline manufacturer code, production start date, defect production end date, total production volume of affected engines or vehicles, estimated or potential number of engines or vehicles affected, actual number identified, estimated affected percentage, make, model, additional model identifier, specific displacement(s) impacted description, specific transmission(s) impacted description, related defect report indicator, related EPA defect report identifier, related defect description, remediation description, proposed remedy supporting information, description of the impact on fuel economy of defect remediation, description of the impact on drivability from remediation, description of the impact on safety from remediation, recalled source description, part availability method description, repair performance/maintenance description, repair instructions, nonconformity correction procedure description, nonconformity estimated correction date, defect remedy time, defect remedy facility, owner demonstration of repair eligibility description, owner determination method description, owner notification method description, owner notification start date, owner notification final date, number of units involved in recall, calendar quarter, calendar year, quarterly report number, related EPA recall report/remedial plan identifier, number of sources inspected, number of sources needing repair, number of sources receiving repair, number of sources ineligible due to improper maintenance, number of sources ineligible for repair due to exportation, number of sources ineligible for repair due to theft, number of sources ineligible for repair due to scrapping, number of sources ineligible for repair due to other reasons, additional owner notification indicator, and the number of owner notifications sent. We are not including defect investigation reports in this category, instead the part 2 process will continue to apply as described in Section XI.A.1.iv for defect investigation reports. Additionally, a portion of the information included in this category is emissions data under another subsection of the regulatory definition of emissions data, as discussed in more detail in Section XI.A.1.i.a, as it is also “[i]nformation necessary to determine the identity, amount, frequency, concentration, or other characteristics (to the extent related to air quality) of any emission which has been emitted by the source (or of any pollutant resulting

<sup>565</sup> *Id.*

<sup>566</sup> 40 CFR 2.301(a)(2)(i)(A).

<sup>567</sup> 40 CFR 2.301(a)(2)(i)(B).

<sup>564</sup> *Id.*

from any emission by the source), or any combination of the foregoing[.]”<sup>568</sup>

*SEA Compliance Information:* We are determining that the SEA compliance information category is emission data because it is necessary to determine whether a source complies with its certificate and the standards. This category includes the facility name and location where the SEA was conducted, number of tests conducted, model year, build date, hours of operation, location of accumulated hours, the date the engines shipped, how the engines were stored, and, for imported engines, the port facility and date of arrival. This information collected through SEAs is necessary for determining whether a source that was investigated through an SEA complies with the applicable standards. For that reason, EPA is determining that this category is emission data as defined at 40 CFR 2.301(a)(2)(i)(B). Additionally, certain information collected during an SEA is included in the test information and results category. We determine that SEA compliance information is emission data because it is both paragraph B information and “[i]nformation necessary to determine the identity, amount, frequency, concentration, or other characteristics (to the extent related to air quality) of any emission which has been emitted by the source (or of any pollutant resulting from any emission by the source), or any combination of the foregoing[.]”<sup>569</sup>

iv. Information that is emission data because it provides a general description of the location and/or nature of the source to the extent necessary to identify the source and to distinguish it from other sources (including, to the extent necessary for such purposes, a description of the device, installation, or operation constituting the source).

We are determining that certain categories of information meet the regulatory definition of emission data under 40 CFR 2.301(a)(2)(i)(C) because they convey a “[g]eneral description of the location and/or nature of the source to the extent necessary to identify the source and to distinguish it from other sources (including, to the extent necessary for such purposes, a description of the device, installation, or operation constituting the source).”<sup>570</sup> We will refer to subparagraph (C) in the definition of emission data as “paragraph C information” throughout this section. We are determining that two categories of information fall primarily under this regulatory

definition of emissions data: (1) Source family information, and (2) production volume information. We determine these categories are paragraph C information and are, therefore, emission data and not entitled to confidential treatment. However, under this determination, consistent with 40 CFR 2.301(a)(2)(ii), we will not release information included in an application for certification prior to the introduction-into-commerce-date, except under the limited circumstances already provided for in that regulatory provision.

*Source Family Information:* The information included in the source family information category includes engine family information, vehicle family information, evaporative family information, equipment family information, subfamily name, engine family designation, emission family name, and test group information. The engine, vehicle, and evaporative family information includes information necessary to identify the emission source for which the certificate was issued; this determines the emission standards that apply to the source and distinguishes the source’s emissions from other sources. Manufacturers request certification using the family name of the engines, vehicles, or equipment they intend to produce for sale in the United States. Test group information identifies the sources tested and covered by a certificate. The source family is the basic unit used to identify a group of sources for certification and compliance purposes. The source family is a code with 12 digits that identifies all parts of that source. More specifically, information conveyed in the source family code include the model year, manufacturer, industry sector, engine displacement, and the manufacturer’s self-designated code for the source family. We are determining that the source family information category of information is emission data because it is information that provides a “[g]eneral description of the location and/or nature of the source to the extent necessary to identify the source and to distinguish it from other sources (including, to the extent necessary for such purposes, a description of the device, installation, or operation constituting the source).”<sup>571</sup>

*Production Volume:* Additionally, we are determining that production volume is emission data necessary to identify the source. Where the source is each individual engine, vehicle, or equipment produced, the production volume provides information necessary

for EPA or the public to identify that source (the certificate only identifies one source, where the production volume identifies all the sources) and distinguish that source’s emissions from the emissions of other sources. In other words, actual production volume provides necessary information to identify the number of sources operating under a certificate of conformity and distinguish their total emissions from other sources. In this way, the total number of sources operating under a certificate of conformity provides a “[g]eneral description . . . of nature of the source” or, alternatively, provides information necessary such that the source can be identified in total, since it is generally unlikely that only a single unit of any engine, vehicle, or equipment would be produced under a certificate. For this additional reason, we determine that the production volume category is emission data, not only for the reasons provided in Sections X.A.1.i.a and b, but also because it also provides a “[g]eneral description of the location and/or nature of the source to the extent necessary to identify the source and to distinguish it from other sources (including, to the extent necessary for such purposes, a description of the device, installation, or operation constituting the source).”<sup>572</sup>

v. Information submitted as preliminary and superseded will have the same confidentiality treatment as the final reported information.

In the course of certifying and demonstrating compliance, manufacturers may submit information to EPA before the applicable deadline, and may update or correct that information before the deadline for certification or compliance reporting. Similarly, manufacturers routinely update their applications for certification to include more or different information. EPA treats this information as an Agency record as soon as it is received through the Engine and Vehicle Certification Information System (EVCIS). We are applying the same confidentiality determinations to this “early” information by category as we are making for the information included in the final certification request or compliance report in the categories generally. EPA generally does not intend to publish or release such preliminary or superseded information, because we believe the inclusion of preliminary information in Agency publications could lead to an inaccurate or misleading understanding of emissions or of a manufacturer’s compliance status. However, because

<sup>568</sup> 40 CFR 2.301(a)(2)(i)(A).

<sup>569</sup> *Id.*

<sup>570</sup> 40 CFR 2.301(a)(2)(i)(C).

<sup>571</sup> 40 CFR 2.301(a)(2)(i)(C).

<sup>572</sup> *Id.*

such early information becomes an Agency record upon receipt, we may be obligated to release information from those preliminary or superseded documents that is not entitled to confidential treatment if a requester specifically requests such pre-final information in a FOIA request. In such circumstances, we intend to provide a statement regarding the preliminary or superseded nature of the information in the final FOIA response. EPA also does not intend to disclose information in submitted reports until we have reviewed them to verify the reports' accuracy, though the Agency may be required to release such information if it is specifically requested under the FOIA. Note that this subsection's determinations and intended approaches for preliminary and superseded information submitted as part of the certification and compliance reporting processes apply only to such information for those categories of information where we are making confidentiality determinations in this final rule. In other words, this subsection is not intended to address preliminary or projected information for the types of information we are not including in the determinations made in this final rule and that remain subject to the part 2 process (see Section XI.A.1.iv).

vi. Information that is never entitled to confidential treatment because it is publicly available or discernible information or becomes public after a certain date.

We are also determining that information that is or becomes publicly available under the applicable standard-setting parts is not entitled to confidential treatment by EPA.

Information submitted under the standard-setting parts generally becomes publicly available in one of two ways:

(1) Information is required to be publicly disclosed under the standard-setting parts, or (2) information becomes readily measurable or observable after the introduction-to-commerce date. Information that is required to be publicly available under the standard-setting parts includes: Information contained in the fuel economy label, the vehicle emission control information ("VECI") label, the engine emission control information label, owner's manuals, and information submitted by the manufacturer expressly for public release. The information in the labels is designed to make the public aware of certain emissions related information and thus is in no way confidential. Similarly, manufacturers submit documents specifically prepared for public

disclosure to EPA with the understanding that they are intended for public disclosure. We determine that these public facing documents are not entitled to confidential treatment, as they are prepared expressly for public availability.

Additionally, we are determining that the types of information provided in the next paragraph that are measurable or observable by the public after the source is introduced into commerce are not entitled to confidential treatment by EPA after the introduction-to-commerce date. This information may also be emission data and included in the one of the categories established in this action, accordingly, we determine that it is emission data as described in Section XI.A.1.i. The fact that this information is or becomes publicly available is an additional reason for it to be not entitled to confidential treatment after the introduction into commerce date, and is an independent alternative basis for our determination that the information is not entitled to confidential treatment.

This information includes: Model and parts information, source footprint information, manufacturer, model year, category, service class, whether the engine is remanufactured, engine type/category, engine displacement, useful life, power, payload tons, intended application, model year, fuel type, tier, and vehicle make and model. Footprint information is readily observable by the public after the introduction-to-commerce date, as one can measure and calculate that value once the source is introduced into commerce.

Additionally, models and parts information is also readily available to the public after the source is introduced into commerce. Because this information is publicly available, it is not entitled to confidential treatment. Therefore, we will not provide any additional notice or process prior to releasing these type of information in the future.

vii. Information not included in this rule's determinations will be treated as confidential, if the submitter claimed it as such, until a confidentiality substantiation is submitted and a determination made under the 40 CFR part 2 process.

We are not making a confidentiality determination under 40 CFR 1068.11 for certain information submitted to EPA for certification and compliance. This information, if claimed as confidential by the submitters, will be treated by EPA as confidential until such time as it is requested under the FOIA or EPA otherwise goes through a case-by-case or class determination process under 40 CFR part 2. At that time, we will make

a confidentiality determination in accordance with 40 CFR part 2, and as established in this rulemaking under 40 CFR 2.301(j)(4). This final action supersedes the Table 3 CBI class determinations that EPA previously made in 2013, such that the same categories of information in Table 3 will not have an applicable class determination and will now be subject to the 40 CFR part 2 process.

The types of information we are not including in the determinations made in this final rule, and remain subject to the part 2 process, includes:

- (1) Projected production and sales,
  - (2) Production start and end dates outside of the defect and recall context,
  - (3) Specific and detailed descriptions of the emissions control operation and function,
  - (4) Design specifications related to aftertreatment devices,
  - (5) Specific and detailed descriptions of auxiliary emission control devices (AECs),
  - (6) Plans for meeting regulatory requirements (*e.g.*, ABT pre-production plans),
  - (7) Procedures to determine deterioration factors and other emission adjustment factors and any information used to justify those procedures,
  - (8) Financial information related to ABT credit transactions (including dollar amount, parties to the transaction and contract information involved) and manufacturer bond provisions (including aggregate U.S. asset holdings, financial details regarding specific assets, whether the manufacturer or importer obtains a bond, and copies of bond policies),
  - (9) Serial numbers or other information to identify specific engines or equipment selected for testing,
  - (10) Procedures that apply based on the manufacturers request to test engines or equipment differently than we specify in the applicable standard-setting parts,
  - (11) Information related to testing vanadium catalysts in 40 CFR part 1065, subpart L (established in this rule),
  - (12) GPS data identifying the location and route for in-use emission testing, and
  - (13) Defect investigation reports. The information contained in defect investigation reports may encompass both emission data and information that may be CBI, so we are not making a determination for this report as whole. Instead, procedurally we will treat these reports in accordance with the existing part 2 process.
- Additionally, we are creating a category of information to include information EPA received through

“comments submitted in the comment field,” where the Agency’s compliance reporting software has comment fields to allow manufacturers to submit clarifying information in a narrative format. We are not making a determination on this broad category of potential information at this time, as the narrative comments may or may not contain emission data. Therefore, EPA will undertake a case-by-case determination pursuant to 40 CFR part 2 for any information provided in a comment field. As explained earlier in this subsection, after further consideration, this final action supersedes the Table 3 CBI class determination made in 2013 and EPA is also not making a determination at this time regarding whether the information in Table 3 of the 2013 determination may meet the definition of emission data or otherwise may not be entitled to confidential treatment in certain circumstances under individual standard-setting parts, and instead thinks that a case-by-case determination process is better suited to these categories of information.

## 2. Adjustable Parameters

One of the goals of the certification process is to ensure that the emission controls needed to meet emission standards cannot be bypassed or rendered inoperative. Consistent with this goal, the standard-setting parts generally require that engines, vehicles, and equipment with adjustable parameters meet all the requirements of part 1068 for any adjustment in the physically adjustable range. This applies for testing pre-production engines, production engines, and in-use engines.

The underlying principles of the current regulations and policy can be traced to the early emission standards for mechanically controlled engines. The regulations at 40 CFR 86.094–22(e) illustrate how the relevant provisions currently apply for heavy-duty highway engines. The earliest generation of engines with emission control technology subject to emission standards included components such as simple screws to adjust a variety of engine operating parameters, including fuel-air ratio and idle speed. Owners were then able to adjust the engines based on their priority for power, efficiency, or durability. At the same time, manufacturers sought to reduce emissions by limiting the physical range of adjustment of these parameters, so EPA developed regulations to ensure that the engines’ limitations were sufficiently robust to minimize

operation outside the specified range (48 FR 1418, January 12, 1983).

Since then, heavy-duty highway engine manufacturers have developed new technologies that did not exist when we adopted the existing regulations related to adjustable parameters. The regulations at 40 CFR 86.094–22(e) therefore provide a limited framework under which to administer the current certification for heavy-duty highway engines. Current certification practice consists of applying these broad principles to physically adjustable operating parameters in a way that is similar for both highway and nonroad applications. EPA developed guidance with detailed provisions for addressing adjustable parameters at certification for land-based nonroad spark-ignition engines at or below 19 kW.<sup>573</sup> To date, programmable operating parameters have generally not been treated as adjustable parameters for Federal regulatory purposes, except that manufacturers need to identify all available operating modes (such as eco-performance or rabbit/turtle operation).

EPA’s Office of Enforcement and Compliance Assurance (OECA) has found extensive evidence of tampering with the electronic controls on heavy-duty engines and vehicles nationwide, although EPA lacks robust data on the exact rate of tampering.<sup>574</sup> Recently, OECA announced a new National Compliance Initiative (“NCI”) to address the manufacture, sale, and installation of defeat devices on vehicles and engines through civil enforcement.<sup>575</sup> Section VI.C includes a discussion on the potential for significant increases in emissions from tampering with current heavy-duty engines, and the provisions in the final rule that we expect will reduce incentives to tamper with model year 2027 and later heavy-duty engines.

Manufacturers are required by existing regulations to describe in their application for certification how they address potentially adjustable operating parameters. As with all elements of certification, the regulations require

<sup>573</sup> “Clean Air Act Requirements for Small Nonroad Spark-Ignition Engines: Reporting Adjustable Parameters and Enforcement Guidance,” EPA Guidance CD–12–11 (Small SI Guidance), August 24, 2012.

<sup>574</sup> U.S. EPA. “Tampered Diesel Pickup Trucks: A Review of Aggregated Evidence from EPA Civil Enforcement Investigations”, November 20, 2021, Available online: <https://www.epa.gov/enforcement/tampered-diesel-pickup-trucks-review-aggregated-evidence-epa-civil-enforcement>.

<sup>575</sup> U.S. EPA. National Compliance Initiative: Stopping Aftermarket Defeat Devices for Vehicles and Engines. Available online: <https://www.epa.gov/enforcement/national-compliance-initiative-stopping-aftermarket-defeat-devices-vehicles-and-engines>.

manufacturers to use good engineering judgment for decisions related to adjustable parameters. The regulations also describe a process for manufacturers to ask for preliminary approval for decisions related to new technologies, substantially changed engine designs, or new methods for limiting adjustability. See, for example, 40 CFR 1039.115 and 1039.210. Note that the certification requirements described in this section for manufacturers apply equally to anyone certifying remanufactured engines or associated remanufacturing systems where such certification is required.

We are adopting a new 40 CFR 1068.50 to update the current regulatory provisions such that the established principles and requirements related to adjustable parameters also apply for current technologies. Thus, the new provisions indicate how our established principles regarding adjustable parameters apply for the full range of emission control technologies.

The provisions are largely based on regulations that already apply for highway engines and vehicles under 40 CFR 86.094–22(e) and 86.1833–01. Most of what we are adopting in 40 CFR 1068.50 is an attempt to codify in one place a set of provisions that are consistent with current practice. Some provisions may represent new or more detailed approaches, as described further in the following paragraphs, especially in the context of electronic controls. The provisions in the final 40 CFR 1068.50 are intended to apply broadly across EPA’s engine, vehicle, and equipment programs. The language is intended to capture the full range of engine technologies represented by spark-ignition and compression-ignition engines used in highway, nonroad, and stationary applications. We are accordingly applying the new provisions for all the types of engines, vehicles and equipment that are broadly subject to 40 CFR part 1068, as described in 40 CFR 1068.1. For example, the provisions apply for nonroad sectors and for heavy-duty highway engines, but not for highway motorcycles or motor vehicles subject to standards under 40 CFR part 86, subpart S. Note that regulatory provisions for adjustable parameters refer to engines, because most adjustable parameters are integral to the engine and its controls. In the case of equipment-based standards and alternative power configurations such as electric vehicles, the requirement to meet emission standards across the physically adjustable range. As with other provisions in 40 CFR part 1068, if the standard-setting part specifies some

provisions that are different than 40 CFR 1068.50, the provisions in the standard-setting part apply instead of the provisions in 40 CFR 1068.50. For example, we will continue to rely on the provisions related to adjusting air-fuel ratios in 40 CFR part 1051 for recreational vehicles in addition to the new provisions from 40 CFR 1068.50. In this final rule, we are also making some minor adjustments to the regulatory provisions in the standard-setting parts to align with the language in 40 CFR 1068.50.

The regulations in this final rule include several changes from the proposed rule. We have added the word “significant” as a qualifying term for the amount of emissions impact required from the adjustment of an operating parameter for an operating parameter to be considered an adjustable parameter. This term was missed in the proposed migration of adjustable parameter language from 40 CFR 86.094–22(e)(1)(ii) to 40 CFR 1068.50. We have also updated the language and organization of 40 CFR 1068.50 to make the regulation easier to read. This update in language is not meant to change the meaning of the terms, only to provide greater consistency in the intent of our regulation. We did this by changing “mechanically controlled parameter” to “physically adjustable parameter” and “electronically controlled parameter” to “programmable parameter”. We updated our terminology of tools used to determine whether operating parameters are considered practically adjustable by changing from “simple tools” to “ordinary tools”. We also updated the list of ordinary tools to be a specific list of tools used in their intended manner for engines less 30 kW, expanding this list for 30–560 kW engines, and allowing any available tools for engines above 560 kW. We did this to stay consistent with the existing Small SI Guidance. We added a time limit for determining whether operating parameters are considered practically adjustable for engines above 560 kW as it would be unreasonable to allow an unlimited amount of time for a mechanic to modify an engine in this determination. We have updated 40 CFR 1068.50 to address crimped fasteners and bimetal springs and removed the limitation of only applying the physically adjustable parameter requirements of crimped fasteners and bimetal springs to mechanically controlled engines since bimetal springs and crimped fasteners are not limited in use to mechanically controlled engines. To remain consistent with the Small SI

Guidance, we have added extraordinary measures as an exception for determining the practical adjustability of an operating parameter. We have also added removal of cylinder heads as an extraordinary measure as any modification of internal engine components requires specialty knowledge and there can be a high degree of difficulty in removing cylinder heads. To address concerns about listing all programmable variables as operating parameters, which could affect thousands of different control strategies, we will allow all programmable parameters not involving user-selectable controls to be a single, collective operating parameter. We have removed the requirement for potting or encapsulating circuit boards in a durable resin as a requirement for tamper-proofing programmable controls since anyone tampering with programmable controls would almost certainly accomplish that as a software change through reflashing rather than modifying circuit boards directly. We have adjusted the date for implementing the new adjustable-parameter provisions as described in the next section. See the Response to Comments for a more thorough discussion of the comments.

#### i. Lead Time

We proposed to apply the adjustable-parameter requirements of 40 CFR 1068.50 starting in model year 2024. This short lead time was based on (1) the expectation that the new regulation was only modestly different than existing requirements for physically adjustable operating parameters and (2) the proposed requirements for programmable operating parameters were intended to substantially align with manufacturers’ current and ongoing efforts to prevent in-use tampering. Considering these factors, we proposed model year 2024 to provide a short lead time that would be sufficient for manufacturers. This lead time would also allow EPA time to prepare internal processes for handling the additional information.

As detailed in the Response to Comments document, the Truck and Engine Manufacturers Association, the Outdoor Power Equipment Institute, and Cummins suggested that the final rule should allow more time to comply with the new requirements.

We are revising the final rule from the proposal to specify that the final adjustable-parameter provisions in 40 CFR 1068.50 start to apply in model year 2027. Until then, manufacturers may optionally comply with 40 CFR 1068.50 early, but will otherwise continue to be subject to adjustable

parameter provisions as established for each standard-setting part.

Our starting expectation is that EPA and manufacturers have a mutual interest in preventing tampering with in-use engines. We also understand, as described further in this section, that it is not possible to adopt a single standard for tamper-proofing electronic controls that will continue to be effective years into the future. Discussion of the certification process in section XI.A.2.iii therefore clarifies that EPA reviewers intend to consider the totality of the circumstances as we determine whether a manufacturer’s effort to prevent inappropriate in-use adjustments is adequate. That consideration may involve, for example, EPA assessing the most recent provisions adopted in voluntary consensus standards, the extent to which manufacturers of similar engines have taken steps to prevent tampering, any reports of tampering with an individual manufacturer’s in-use engines, and the availability of replacement parts or services intended to bypass emission controls. EPA review of engine designs would account for the practical limitations of designing engine upgrades, both for initial approval under 40 CFR 1068.50 and for year-by-year review of certification applications as time passes.

As a result, we expect to work with manufacturers to establish and implement plans to incorporate reasonable tamper-proofing designs, consistent with prevailing industry practices, in a reasonable time frame. We understand that tying compliance to prevailing industry practices creates a measure of ambiguity regarding the deadline to comply for model year 2027. We would generally expect manufacturers to successfully certify based on their current and upcoming efforts to protect their engines from maladjustment. Some manufacturers will have plans for making additional changes to their engines beyond model year 2027. We can also work with such manufacturers to plan for making those additional changes in later model years if, for example, their further technology development moves them in the direction of improving engine control module (ECM) security with up-and-coming designs. Manufacturers might also need additional time to deploy established technologies for niche products after implementing those improvements in their high-volume product lines. This dynamic regarding the lead time for meeting requirements in model year 2027 is no different than what will apply in the future any time there is a development or innovation

that leads manufacturers to integrate the next generation of tamper-proofing across their product line.

ii. Operating Parameters, Adjustable Parameters, and Statement of Adjustable Range

The regulation establishes that operating parameters are features that can be adjusted to affect engine performance, and that adjustable parameters are operating parameters that are practically adjustable by a user or other person by physical adjustment, programmable adjustment, or regular replenishment of a fluid or other consumable material. However, we do not consider operating parameters to be adjustable parameters if the operating parameters are permanently sealed or are not practically adjustable, or if we determine that engine operation over the full range of adjustment does not affect emissions without also degrading engine performance to the extent that operators will be aware of the problem. For example, while spark plug gap and valve lash are operating parameters that can be adjusted to affect engine performance, we do not treat them as adjustable parameters because adjusting them does not affect emissions without also degrading engine performance to the extent that operators will be aware of the problem. The following sections describes how we consider whether parameters are practically adjustable.

a. Physically Adjustable Operating Parameters

In the final 40 CFR 1068.50(e), a physically adjustable parameter is considered “practically adjustable” for engines at or below 30 kW if a typical user can adjust the parameter with ordinary tools within 15 minutes using service parts that cost no more than \$30.<sup>576</sup> Similarly, a physically adjustable parameter is considered “practically adjustable” for 30–560 kW engines if a qualified mechanic can adjust the parameter with ordinary tools within 60 minutes using service parts that cost no more than \$60. The term “ordinary tools” is defined in the final regulations based on the size of the engine. For engines at or below 30 kW,

the definition includes slotted and Phillips head screwdrivers, pliers, hammers, awls, wrenches, electric screwdrivers, electric drills, and any tools supplied by the manufacturer, where those tools are used for their intended purpose. For 30–560 kW engines, the definition includes all ordinary tools specified for engines at or below 30 kW and also includes solvents, or other supplies that are reasonably available to the operator and any other hand tools sold at hardware stores, automotive parts supply stores, or on the internet. These thresholds are intended to be consistent with the provisions that apply under current regulations but tailored to represent an appropriate level of deterrence relative to typical maintenance experiences for the different sizes of engines.

For engines above 560 kW, a physically adjustable parameter is considered “practically adjustable” if a qualified mechanic can adjust the parameter using any available tools within 60 minutes. We are not setting a cost threshold for engines above 560 kW because of the very large costs for purchasing, servicing, and operating these engines. Owners of these low-volume, high-cost engines are more likely to have ready access to experienced mechanics to continuously manage the maintenance and performance of their engines. For example, owners of marine vessels often have engineers traveling with vessels to always be ready to perform extensive repairs or maintenance as needed. Owners of engines above 560 kW also commonly do their own work to substantially overhaul engines. We expect this arrangement for qualifying adjustable parameters will cause manufacturers to develop designs for properly limiting adjustability of engines above 560 kW.

Physically adjustable parameters usually have physical limits or stops to restrict adjustability. Specific characteristics are identified in the final 40 CFR 1068.50(f) to illustrate how physical limits or stops should function to control the adjustable range. For example, a physical stop defines the limit of the range of adjustability for a physically adjustable operating parameter if operators cannot exceed the travel or rotation limits using the appropriate tools without causing damage exceeding specified thresholds.

We are changing the proposed provisions in this final rule to include reference to extraordinary measures. We will not require manufacturers to extend the physically adjustable range to account for such extraordinary measures. The final regulation

establishes the following steps as extraordinary measures: Removing a cylinder head from the engine block, fully or partially removing a carburetor, drilling or grinding through caps or plugs, causing damage to the engine or equipment that would exceed the specified time or cost thresholds, or making special tools to override design features that prevent adjustment. Note that extraordinary measures do not include purchase of such special tools if they become available for purchase.

b. Programmable Operating Parameters

The final 40 CFR 1068.50(e)(2) states that programmable operating parameters will be considered “practically adjustable” if they can be adjusted using any available tools (including devices that are used to alter computer code). This will apply for engines with any degree of electronic control. The final 40 CFR 1068.50(e) will also include special provisions for determining whether electronic control modules that can be adjusted by changing software or operating parameters (“reflashed”) are practically adjustable and to determine the practically adjustable range. First, where any of the following characteristics apply for a given electronic parameter, it will be considered practically adjustable:

- If an engine family includes multiple operating modes or other algorithms that can be selected or are easily accessible, the operating parameter will be practically adjustable and each of the selectable or accessible modes or settings will be within the practically adjustable range.
- If the manufacturer sells software (or other tools) that an experienced, independent mechanic could use to reflash or otherwise modify the electronic control module, the operating parameter will be practically adjustable and all those settings will be within the practically adjustable range.
- If the engines/equipment have other electronic settings that can be adjusted using any available service tools (such as fuel injection maps), the operating parameter will be practically adjustable and all those settings will be within the practically adjustable range.

Injection fuel maps and other similar electronic parameters will not be considered practically adjustable if the manufacturer adequately prevents access to the electronic control modules with encryption or password protection consistent with good engineering judgment, such as having adequate protections in place to prevent distribution and use of passwords or encryption keys. Manufacturers will be able to exclude electronic operating

<sup>576</sup> The cost thresholds do not include the cost of labor or the cost of any necessary tools or nonconsumable supplies; the time thresholds refer to the time required to access and adjust the parameter, excluding any time necessary to purchase parts, tools, or supplies or to perform testing. These costs are in 2020 dollars. Manufacturers will adjust these values for certification by comparing to the most recently available Consumer Price Index for All Urban Consumers value published by the Bureau of Labor Statistics [www.bls.gov/data/inflation\\_calculator.htm](http://www.bls.gov/data/inflation_calculator.htm).

parameters from being considered adjustable parameters (or identify them as adjustable parameters but narrow the adjustable range) where they appropriately determine that the operating parameters will not be subject to in-use adjustment; EPA retains the right to review the appropriateness of such statements. The final regulations also allow us to specify conditions to ensure that the certified configuration includes electronic parameter settings representing adjustable ranges that reflect the expected range of in-use adjustment or modification.

To address the safety, financial liability, operational, and privacy concerns which can result from tampering, manufacturers, industry organizations, and regulators have been working to develop standards and design principles to improve the security of ECMs. Three such efforts where cybersecurity guidelines and procedures are either under development or already in publication are ISO/SAE J21434, UNECE WP29 Cybersecurity Regulation, and SAE J3061.<sup>577 578 579</sup> Since security principles are constantly evolving as new threats are identified, it is impractical to codify specific requirements to be applied in an annual emission certification process. However, we expect to require manufacturers to update their tamper-resistance features over time to keep up with industry best practices. In addition, manufacturers may choose to utilize different mixes of technical standards or principles of those recommended by these organizations, and a one-size-fits-all approach with detailed requirements for ECM security will be neither practical nor prudent. Manufacturers need the flexibility to quickly implement measures to address new or emerging threats and vulnerabilities. Accordingly, the final regulation specifies that the manufacturer's application for certification must identify their ECM security measures. Manufacturers need to describe the measures they are using, whether proprietary, industry technical standards, or a combination of both, to prevent unauthorized access to the ECM. At a minimum, for determining

whether the parameter is an operating parameter or an adjustable parameter, this documentation will need to describe in sufficient detail the measures that a manufacturer has used to prevent unauthorized access; ensure that calibration values, software, or diagnostic features cannot be modified or disabled; and respond to repeated, unauthorized attempts at reprogramming or tampering.

Some commenters expressed a concern that state or Federal "right to repair" legislation may conflict with EPA's requirement to limit access to an engine's electronic controls, and one commenter suggested edits creating an exception in EPA's proposed regulation intended to address such a conflict. Commenters did not specifically identify how any specific existing state or Federal law conflicts with EPA's regulation, and we are finalizing the requirements as described in this section without the suggested exception. See section 30.2 of the Response to Comments for further detail on comments received and EPA's responses.

#### c. Aftermarket Fuel Conversions

Aftermarket fuel conversions for heavy-duty highway engines and vehicles are a special case. We expect aftermarket converters to continue their current practice of modifying engines to run on alternative fuels under the clean alternative fuel conversion program in 40 CFR part 85, subpart F. The anti-tampering provisions in the final 40 CFR 1068.50 are not intended to interfere with actions aftermarket converters may need to take to modify or replace ECMs as part of the conversion process consistent with 40 CFR part 85, subpart F. The final provisions direct manufacturers to prevent unauthorized access to reprogram ECMs. Aftermarket converters will presumably need to either use a replacement ECM with a full calibration allowing the engine to run on the alternative fuel or perhaps create a piggyback ECM that modifies the engine's calibration only as needed to accommodate the unique properties of the alternative fuel. Aftermarket converters can alternatively work with engine manufacturers to access and change the engine's existing ECM programming for operation on the alternative fuel.

#### d. Consumption, Replenishment, and the Certified Configuration

Certain elements of design involving consumption and replenishment may be considered adjustable parameters. Two significant examples are DEF tank fill

level and hybrid battery state of charge. The final provisions in 40 CFR 1068.50(h) address these issues.

For these adjustable parameters, the range of adjustability is determined based on the likelihood of in-use operation at a given point in the physically adjustable range. We may determine that operation in certain subranges within the physically adjustable range is sufficiently unlikely that the subranges may be excluded from the allowable adjustable range for testing. In such cases, the engines/equipment are not required to meet the emission standards for operation in an excluded subrange.

The final 40 CFR 1068.50(h) describes how we will not require new engines to be within the range of adjustability for a certified configuration for adjustments related to consumption and replenishment. Specifically, manufacturers will not violate the prohibition in 40 CFR 1068.101(a)(1) by introducing into commerce a vehicle with an empty DEF tank or an uncharged hybrid battery.

Except for these special cases related to consumption and replenishment, final 40 CFR 1068.50(k) specifies that engines are not in the certified configuration if manufacturers produce them with adjustable parameters set outside the range specified in the application for certification. Similarly, engines are not in the certified configuration if manufacturers produce them with other operating parameters that do not conform to the certified configuration. Such engines will therefore not be covered by a certificate of conformity in violation of 40 CFR 1068.101(a)(1).

#### iii. Certification Process

The existing regulations in each standard-setting part describe how manufacturers need to identify their adjustable parameters, along with the corresponding physical stops and adjustable ranges. The existing certification process includes a review of the manufacturer's specified adjustable parameters, including consideration of the limits of adjustability. This has generally focused on physically adjustable parameters. Under the new regulations, we intend to consider the totality of the circumstances as we determine whether a manufacturer's effort to prevent inappropriate adjustment is adequate. See text further clarifying this principle in final 40 CFR 1068.50(i). Under the existing certification process, we may also evaluate the appropriateness of a manufacturer's statement regarding an adjustable parameter if we learn from

<sup>577</sup> "Road vehicles—Cybersecurity engineering", ISO/SAE FDIS 21434, <https://www.iso.org/standard/70918.html>.

<sup>578</sup> United Nations Economic Commission for Europe, "UNECE WP29 Automotive Cybersecurity Regulation", Available online: [unece.org/DAM/trans/doc/2020/wp29grva/ECE-TRANS-WP29-2020-079-Revised.pdf](https://www.unece.org/DAM/trans/doc/2020/wp29grva/ECE-TRANS-WP29-2020-079-Revised.pdf).

<sup>579</sup> Society of Automotive Engineers, "Cybersecurity Guidebook for Cyber-Physical Vehicle Systems". SAE J3061, Available online: [https://www.sae.org/standards/content/j3061\\_201601/](https://www.sae.org/standards/content/j3061_201601/).

observation of in-use engines with such parameters or other information that a parameter was in fact practically adjustable or that the specified adjustable range was in fact not correct.

We are requiring manufacturers in the certification application to state, with supporting justification, that they designed physically adjustable operating parameters to prevent in-use adjustment outside the intended adjustable range, that they designed physically adjustable parameters to prevent in-use operation outside the intended adjustable range, and that they have limited access to the electronic controls as specified in 40 CFR 1068.50 to prevent in-use adjustment of operating parameters and prevent in-use operation outside the intended adjustable range. We are clarifying in this rule that manufacturers must consider programmable parameters to be operating parameters that may also be adjustable. All operating modes available for selection by the operator must be described in the certification application and are considered adjustable parameters and fall within the engine's practically adjustable range; however, programmable parameters that do not involve user-selectable controls can be described as a single operating parameter. The manufacturer must describe in the certification application how they have restricted access to the electronic controls to prevent unauthorized modification of in-use engines. Manufacturers will need to follow accepted industry best practices to include password restrictions, encryption, two-step authentication, and other methods as appropriate. Manufacturers will need to implement those newer methods as practices change over time, especially where there are observed cases of unauthorized changes to in-use engines.

Manufacturers must name all available operating modes in the application for certification and describe their approach for restricting access to electronic controls. This description must include naming any applicable encryption protocols, along with any additional relevant information to characterize how the system is designed to prevent unauthorized access. Manufacturers must separately identify information regarding their auxiliary emission control devices. Manufacturers will not need to report additional detailed programming information describing electronically adjustable operating parameters that are inaccessible to owners.

While EPA retains the right to review the manufacturer's specified adjustable

parameters in the certification process, the manufacturer will be responsible for ensuring all aspects of the manufacturer's statements regarding adjustable parameters are appropriate for each certification application. EPA may review this information each year to evaluate whether the designs are appropriate. As industry practices evolve to improve tamper-resistance with respect to electronic controls, manufacturers will need to upgrade tamper-resistance features to include more effective protocols to support their statement that the electronic controls are both restricted from unauthorized access and limited to the identified practically adjustable range.

The provisions in 40 CFR 1068.50 are not intended to limit the tampering prohibition of 40 CFR 1068.101(b)(1) or the defeat-device prohibition of 40 CFR 1068.101(b)(2). For example, it would be prohibited tampering to bypass a manufacturer's stops. Similarly, aftermarket software that reduces the effectiveness of controls specified by the manufacturer in the application for certification would be a prohibited defeat device.

If EPA discovers that someone manufactures or installs a modified ECM or reflashes an engine's ECM in a way that is not a certified configuration represented in the application for certification, those persons will be liable for violating the tampering prohibition of 40 CFR 1068.101(b)(1) or the defeat-device prohibition in 40 CFR 1068.101(b)(2). As we gather information about cases where third parties have successfully penetrated ECM access restrictions, the manufacturer will be responsible in each certification application for ensuring all aspects of the manufacturer's statements regarding such adjustable parameters are still appropriate and we may also engage with the manufacturer to see if there is need or opportunity to upgrade future designs for better protection.

#### iv. Engine Inspections

EPA may want to inspect engines to determine if they meet the final specifications for adjustable parameters as described in 40 CFR 1068.50. These inspections could be part of the certification process, or we could inspect in-use engines after certification. For example, we may request a production engine be sent to an EPA designated lab for inspection to test the limits of the adjustable parameters as described in 40 CFR 1068.50(j).

#### 3. Exemptions for Engines, Vehicles, and Equipment Under 40 CFR Part 1068, Subparts C and D

40 CFR part 1068, subparts C and D, describe various exemption provisions for engines, vehicles and equipment that are subject to emission standards and certification requirements. We are amending several of these exemption provisions. We received no comments on the proposed exemption provisions and are finalizing the proposed changes without modification. The following paragraphs use the term engines to refer generically to regulated engines, vehicles, and equipment.

The test exemption in 40 CFR 1068.210 applies for certificate holders performing test programs "over a two-year period". We are removing this time limitation. We may impose reasonable time limits on the duration of the exemption for individual engines under another existing provision (40 CFR 1068.210(e)). Such limitations may take the form of a defined time for manufacturers to produce exempt engines, or a defined time for individual engines to remain in exempt status. This exemption applies for a wide range of products and experience has shown that circumstances may call for the exemption to apply for longer than (or less than) two years. We may therefore continue to apply a two-year limit for producing or using exempt engines based on a case-specific assessment of the need for the exemption. We could alternatively identify a shorter or longer exemption period based on the circumstances for each requested exemption. The exemption approval could also allow test engines to operate indefinitely, perhaps with additional conditions on modifying the engine to include software or hardware changes that result from the test program or other design improvements. This approach may be appropriate for manufacturing one or more engines as part of a pilot project to prove out designs and calibrations for meeting new emission standards. Separate provisions apply for importing engines under the testing exemption in 40 CFR 1068.325, which we discuss further later in this section.

The display exemption in 40 CFR 1068.220 applies for using noncompliant engines/equipment for display purposes that are "in the interest of a business or the general public." The regulation disallows the display exemption for private use, private collections, and any other purposes we determine to be inappropriate. We have been aware of several cases involving displays we may



have considered to be in the interest of the general public, but they did not qualify for the display exemption because they were mostly for private use. Experience has shown that it may be difficult to distinguish private and public displays. For example, private collections are sometimes shared with the general public. We are accordingly preserving the fundamental limitation of the display exemption to cases involving the interest of a business or the general public. We are revising 40 CFR 1068.220 to no longer categorically disallow the display exemption for engines and vehicles displayed for private use or for engines in private collections. We are retaining the discretion to disallow the display exemption for inappropriate purposes. This would apply, for example, if engines or vehicles from a private collection will not be displayed for the general public or for any business interest. Consistent with longstanding policy, such private displays do not warrant an exemption from emission standards.

The regulation defines provisions that apply for “delegated assembly” of aftertreatment and other components in 40 CFR 1068.261. Under the current regulation, manufacturers must follow a set of detailed requirements for shipping partially complete engines to equipment manufacturers to ensure that the equipment manufacturer will fully assemble the engine into a certified configuration. A much simpler requirement applies for engine manufacturers that produce engines for installation in equipment that they also produce. Manufacturers have raised questions about how these requirements apply in the case of joint ventures, subsidiary companies, and similar business arrangements. We are revising 40 CFR 1068.261(b) through (d) to clarify that the simpler requirements for intra-company shipments apply for engines shipped to affiliated companies. Conversely, engine manufacturers shipping partially complete engines to any unaffiliated company would need to meet the additional requirements that apply for inter-company shipments. We define “affiliated companies” in 40 CFR 1068.30.

The identical configuration exemption in 40 CFR 1068.315(h) allows for importation of uncertified engines that are identical to engines that have been certified. This might apply, for example, for engines that meet both European and U.S. emission standards but were originally sold in Europe. We are modifying the regulatory language from “identical” to “identical in all material respects.” This change allows

for minor variation in engines/equipment, such as the location of mounting brackets, while continuing to require that engines/equipment remain identical to a certified configuration as described in the manufacturer’s application for certification.

The ancient engine/equipment exemption in 40 CFR 1068.315(i) includes an exemption for nonconforming engines/equipment that are at least 21 years old that are substantially in their original configuration. We originally adopted these for nonroad spark-ignition engines in 2002 to align with a similar exemption that was in place for light-duty motor vehicles (67 FR 68242, November 8, 2002). Now that part 1068 applies for a much wider range of applications, many with very long operating lives, it has become clear that this exemption is no longer appropriate for importing nonconforming engines. Keeping the exemption would risk compromising the integrity of current standards to the extent importers misuse this provision to import high-emitting engines. This was not the original intent of the exemption. We are therefore removing the ancient engine/equipment exemption. The identical configuration exemption will continue to be available to allow importation of nonconforming engines/equipment that continue to be in a configuration corresponding to properly certified engines.

The regulations at 40 CFR 1068.325 describe provisions that apply for temporarily exempting engines/equipment from certification requirements. As noted in the introduction to 40 CFR 1068.325, we may ask U.S. Customs and Border Protection (CBP) to require a specific bond amount to make sure importers comply with applicable requirements. We use the imports declaration form (3520–21) to request CBP to require a bond equal to the value of these imported engines/equipment for companies that are not certificate holders. Several of the individual paragraphs describing provisions that apply for specific exemptions include a separate statement requiring the importer to post bond for these products. We are removing the reference to the bond requirement in the individual paragraphs because the introduction addresses the bonding requirement broadly for all of 40 CFR 1068.325.

We are revising the diplomatic or military exemption at 40 CFR 1068.325(e) to clarify that someone qualifying for an exemption needs to show written confirmation of being qualified for the exemption to U.S.

Customs and Border Protection, not EPA. This may involve authorization from the U.S. State Department or a copy of written orders for military duty in the United States. Consistent with current practice, EPA would not be involved in the transaction of importing these exempted products, except to the extent that U.S. Customs and Border Protection seeks input or clarification of the requirements that apply.

The regulations at 40 CFR 1068.260(c) currently include an exemption allowing manufacturers to ship partially complete engines between two of their facilities. This may be necessary for assembling engines in stages across short distances. It might also involve shipping engines across the country to a different business unit under the same corporate umbrella. The regulation at 40 CFR 1068.325(g) includes additional provisions for cases involving importation. Multi-national corporations might also import partially complete engines from outside the United States to an assembly plant inside the United States. We are revising 40 CFR 1068.325(g) to require that imported engines in this scenario have a label that identifies the name of the company and the regulatory cite authorizing the exemption. This will provide EPA and U.S. Customs and Border Protection with essential information to protect against parties exploiting this provision to import noncompliant engines without authorization.

Most of the exemptions that allow manufacturers to import uncertified engines include labeling requirements to identify the engine manufacturer and the basis of the exemption. We are adding a general requirement in 40 CFR 1068.301 to clarify that labels are required on all exempted engines. In cases where there are no labeling specifications for a given exemption, we are creating a default labeling requirement to add a label for exempted engines to identify the engine manufacturer and the basis of the exemption.

#### 4. Other Amendments to 40 CFR Part 1068

We are adopting the following additional amendments to 40 CFR part 1068:

- *Section 1068.1*: Clarifying how part 1068 applies for older engines. This is necessary for nonroad engines certified to standards under 40 CFR parts 89, 90, 91, 92, and 94 because those emission standards and regulatory provisions have been removed from the CFR. These amendments were inadvertently omitted

from the rule to remove those obsolete parts.

- *Section 1068.1*: Changing 40 CFR 1068.1(a)(4) to include references to 40 CFR parts 1030 and 1031 for aircraft and aircraft engines, instead of the currently listed 40 CFR part 87. 40 CFR part 1068 contains several general compliance provisions, but the only provisions from part 1068 that are relevant to and referenced by the regulations for aircraft and aircraft engines are related to procedures for handling confidential business information and the definition and process for “good engineering judgment.” Revising 40 CFR 1068.1 to reference 40 CFR parts 1030 and 1031 would not impose any new requirements; rather, the updated reference aligns with the existing requirements already established in 40 CFR parts 1030 and 1031. This amendment was not included in the proposal for this rulemaking. However, adopting this change will help readers understand the regulations without adding any new requirements.

- *Section 1068.1*: Clarifying how part 1068 applies for motor vehicles and motor vehicle engines. Vehicles and engines certified under part 86 are subject to certain provisions in part 1068 as specified in part 86. Vehicles and engines certified under parts 1036 and 1037 are subject to all the provisions of part 1068. This correction aligns with regulatory text adopted in previous rulemakings.

- *Section 1068.101(a)*: The regulations at 40 CFR 1068.101(a) set forth the prohibitions that apply for engines and equipment that are subject to EPA emission standards and certification requirements. The regulation includes at 40 CFR 1068.101(a)(2) a prohibition related to reporting and recordkeeping requirements. Section 1068.101(a)(3) similarly includes a prohibition to ensure that EPA inspectors have access to test facilities. These prohibitions derive from CAA section 208(a), which applies the information and access requirements to manufacturers “and other persons subject to the requirements of this part or part C.” The very first provision of 40 CFR part 1068 at 40 CFR 1068.1(a) clearly makes the provisions of part 1068 applicable “to everyone with respect to the engine and equipment categories as described in this paragraph (a)[, . . .] including owners, operators, parts manufacturers, and persons performing maintenance”. However, the regulation in 40 CFR 1068.101(a) as written inadvertently limits the prohibitions to manufacturers. We are accordingly revising the scope of the prohibitions in 40 CFR 1068.101(a)

to apply to both manufacturers and “other persons as provided in 40 CFR 1068.1(a)” in accord with those in CAA section 203(a).

- *Section 1068.101(b)(5)*: Removing extraneous words.
- *Section 1068.240(a)*: Removing reference to paragraph (d) as an alternative method of qualifying for the replacement engine exemption. Paragraph (d) only describes some administrative provisions related to labeling partially complete engines so it is not correct to describe that as an additional “approach for exempting” replacement engines.

- *Section 1068.240(b) and (c)*: Adding text to clarify that owners may retain possession of old engines after installing an exempt replacement engine. This is intended to address a concern raised by engine owners that they generally expect to be able to continue to use a replaced engine.<sup>580</sup> Engine owners stated that they expect to use the replaced engine for either replacement parts or continued use in a different piece of equipment and were surprised to learn that engine manufacturers were insisting that the owner turn ownership of the old engine to the engine manufacturer. The existing regulation disallows simply installing those replaced engines in a different piece of equipment, but destroying the engine block and using the engine core as a source of replacement parts is acceptable under the existing regulation.

- *Sections 1068.601 and 1068.630*: Adding provisions to establish procedures for hearings related to an EPA decision to approve maintenance procedures associated with new technology for heavy-duty highway engines. As described in Section IV.B.5.v, we are updating regulatory provisions related to engine maintenance for heavy-duty highway engines. Section XI.A.9 describes how we may eventually extend those same provisions for nonroad engines. The provisions adopted in this rule include a commitment for EPA to describe approved maintenance for new technology in a **Federal Register** notice, along with an allowance for any manufacturer to request a hearing to object to EPA’s decision. The general provisions related to hearing procedures in 40 CFR part 1068, subpart G, cover the maintenance-related hearing procedures. We are amending the regulation to provide examples of the reasons a manufacturer may request a hearing, including if a manufacturer

believes certain EPA decisions may cause harm to its competitive position, and to add detailed specifications for requesting and administering such a hearing for maintenance-related decisions for heavy-duty highway engines.

5. Engine and Vehicle Testing Procedures (40 CFR Parts 1036, 1037, 1065 and 1066)

The regulations in 40 CFR part 1036, subpart F, 40 CFR part 1037, subpart F, and 40 CFR parts 1065 and 1066 describe emission measurement procedures that apply broadly across EPA’s emission control programs for engines, vehicles, and equipment. This final rule includes several amendments to these regulations.

We are deleting the hybrid engine test procedure in 40 CFR 1036.525 as it was applicable only for model year 2014 to 2020 engines and has been replaced with the hybrid powertrain test procedure for model 2021 and later engines in the existing 40 CFR 1037.550.

We are updating the engine mapping test procedure in 40 CFR 1065.510. To generate duty cycles for each engine configuration, engine manufacturers identify the maximum brake torque versus engine speed using the engine mapping procedures of 40 CFR 1065.510. The measured torque values are intended to represent the maximum torque the engine can achieve under fully warmed-up operation when using the fuel grade recommended by the manufacturer across the range of engine speeds expected in real-world conditions. Historically, the mapping procedure required the engine to stabilize at discrete engine speed points ranging from idle to the electronically limited highest RPM before recording the peak engine torque values at any given speed. We adopted a provision in the final 40 CFR 1065.510(b)(5)(ii) that allows manufacturers to perform a transient sweep from idle to maximum rated speed, which requires less time than stabilizing at each measurement point.

The updates to the engine mapping test procedure in 40 CFR 1065.510 are intended to ensure the resulting engine map achieves its intended purpose. The current test procedure is intended to generate a “torque curve” that represents the peak torque at any specific engine speed point. The transient sweep from idle to maximum rated speed can create engine conditions that trigger electronic control features on modern heavy-duty spark-ignition engines that result in lower-than-peak torque levels. Engine control features that can cause variability in the

<sup>580</sup> Email exchange regarding replacement engines, August 2020, Docket EPA–HQ–OAR–2019–0055.

maximum torque levels include spark advance, fuel-air ratio, and variable valve timing that temporarily alter torque levels to meet supplemental goals (such as torque management for transmissions shifts).<sup>581</sup> If the engine map does not capture the true maximum torque, the duty cycles generated using the map may not accurately recreate the highest-load conditions; this could lead to higher in-use emissions.

We are finalizing updates to 40 CFR 1065.510(a) to require that the torque curve established during the mapping procedure represent the highest torque level possible when using the manufacturer's recommended fuel grade. Specifically, we are requiring manufacturers to disable electronic controls or other auxiliary emission control devices if they are of a transient nature and impact peak torque during the engine mapping procedure.<sup>582</sup> Manufacturers would continue to implement their engine control during duty-cycle testing, enabling their engines to react to the test conditions as they would in real-world operation. The changes to the mapping procedure will ensure that testing appropriately represents torque output and emissions during high-load and transient conditions.

This final rule includes the following additional amendments to 40 CFR parts 1065 and 1066, which we are finalizing as proposed unless specifically noted otherwise:

- *Sections 1065.301 and 1065.1001*: Revising NIST-traceability requirements to allow the use of international standards recognized by the CIPM Mutual Recognition Arrangement without prior EPA approval. The current regulation allows us to approve international standards that are not NIST-traceable, but this was intended only to accommodate laboratories in other countries that meet CIPM requirements instead of following NIST-traceable protocols. With this approach there will no longer be any need for a separate approval process for using international standards that are not NIST-traceable. NIST-traceable standards are traceable to the International System of Units (SI) as specified in NIST Technical Note 1297, which is referenced in the definition of NIST-traceable in 40 CFR part 1065. This same traceability to the

International System of Units is required of standards recognized by the CIPM Mutual Recognition Arrangement, thus putting them on par with NIST-traceable standards.

- *Section 1065.298*: Adopting a new 40 CFR 1065.298 with in-use particulate matter (PM) measurement methods to augment real-time PM measurement with gravimetric PM filter measurement for field-testing analysis. These methods have been approved for use for over 10 years as alternative methods under 40 CFR 1065.10 and 1065.12.

- *Section 1065.410*: Clarifying that manufacturers may inspect engines using electronic tools to monitor engine performance. For example, this may apply for OBD signals, onboard health monitors, and other prognostic tools manufacturers incorporate into their engine designs. As described in the current regulation, inspection tools are limited to those that are available in the marketplace. This prevents engine manufacturers from handling a test engine more carefully than what would be expected with in-use engines. Extending that principle to inspection with electronic tools, we are limiting the use of those inspections to include only information that can be accessed without needing specialized equipment.

- *Section 1065.650(c)(6)*: Adding an allowance to determine nonmethane nonethane hydrocarbon (NMNEHC) for engines fueled with natural gas as 1.0 times the corrected mass of NMHC if the test fuel has 0.010 mol/mol of ethane or more. This may result in a higher reported NMNEHC emission value. The engine manufacturer may use this method if reducing test burden is more important than the potential for a slightly higher reported emission value.

- *Section 1065.720*: Removing the test fuel specification related to volatility residue for liquefied petroleum gas. The identified reference procedure, ASTM D1837, has been withdrawn, at least in part, due to limited availability of mercury thermometers. There is no apparent replacement for ASTM D1837. Rather than adopting an alternative specification for volatility residue, we will instead rely on the existing residual matter specification based on the measurement procedure in ASTM D2158. This alternative specification should adequately address concerns about nonvolatile impurities in the test fuel.

- *Section 1065.910(b)*: Adding a requirement to locate the PEMS during field testing in an area that minimizes the effects of ambient temperature changes, electromagnetic radiation, shock, and vibration. This may involve putting the PEMS in an environmental

enclosure to reduce the effect of these parameters. We are also removing (1) the recommendation to install the PEMS in the passenger compartment because that does not necessarily lead to better mitigation of temperature effects as the cab temperature can vary during vehicle soaks, (2) ambient pressure as a parameter to minimize as there are no known pressure effects on PEMS, and (3) ambient hydrocarbon as a parameter because it is more of a PEMS design issue that is handled with an activated carbon filter on the burner air inlet, which is already covered in 40 CFR 1065.915(c).

- *Section 1065.920*: Broadening the PEMS calibration and verification requirements to make them apply for the new emission measurement bin structure we are adopting in 40 CFR part 1036. The verification is now generic to verifications for both NTE and binned windows for a shift-day of data over 6 to 9 hours. Data would then be processed as they would be for an in-use test (either NTE or binned windows) and compare the performance of the PEMS to the lab-based measurement system.

- *Section 1065.935(d)*: Updating the zero and span verification requirements to include new provisions for the emission measurement bin structure we are adopting in 40 CFR part 1036 and retaining the current requirements for NTE testing only. The procedure now includes the requirement to perform zero-verifications at least hourly using purified air. Span verifications must be performed at the end of the shift-day or more frequently based on the PEMS manufacturer's recommendation or good engineering judgment.

- *Section 1065.935(g)(5)(iii)*: Revising from the proposed provisions for the final rule to clarify the consequences when PEMS gas analyzers (used to determine bin emission values) do not meet zero- or span-drift criteria. The intent is that all the test data would be considered invalid when drift criteria are not met as this indicates a malfunctioning analyzer, calling into question the quality of the data. We have added regulatory text to 40 CFR 1065.935(g)(5)(iii) to invalidate data for the entire shift day if measurements exceed either of the NO<sub>x</sub> analyzer drift limits in 40 CFR 1065.935(g)(5)(iii).

- *Section 1065.935(g)(6)*: Adding a new paragraph to include new drift limits instead of those in 40 CFR 1065.550 for the emission measurement bin structure we are adopting in 40 CFR part 1036. The analyzer zero drift limit between the hourly or more frequent zero verifications is 2.5 ppm, while the limit over the entire shift-day (or more

<sup>581</sup> These AECDS are typically electronic controls that are timer-based and initiated for a set duration. In a transient test, measurements are taken continuously, and the controls remain engaged; the same controls would "time out" if each measurement was taken at stabilized conditions.

<sup>582</sup> These electronic controls would be reported as an AEC under 40 CFR 1036.205(b).

frequently if you perform zero-adjustments) is 10 ppm. The analyzer span drift limit between the beginning and end of the shift-day or more frequent span verification(s) or adjustment(s) must be within  $\pm 4$  percent of the measured span value.

- *Sections 1065.1123, 1065.1125, and 1065.1127*: Adding new regulatory sections to migrate the smoke test procedure in 40 CFR part 86, subpart I, into 40 CFR part 1065. This provides a common location for the test procedure and analyzer requirements for all parts that still require smoke measurement except for locomotive testing. The locomotive test procedure continues to reside in 40 CFR part 1033, subpart F, as it is specific to locomotive testing and operation at specific notches. No updates were made to the procedure that affect analyzer requirements and setup or how a laboratory reports test results. For all engines required to carry out smoke testing, other than locomotive engines, we are updating operation at curb idle speed to instead reference warm idle speed, and we are changing from “rated speed” to instead reference “maximum test speed”. This change should not adversely affect the acceleration and lugging modes of the test and it will make smoke testing consistent with all other engine-based testing that now use warm idle speed and maximum test speed.

- *Part 1066, subpart D*: Incorporating by reference and making applicable as specified in this part an updated version of SAE J2263 for coastdown measurements. The updated standard incorporates EPA guidance for vehicles certified under 40 CFR part 86, subpart S.<sup>583</sup> The updated version of the test method also reduces the wind speed allowed for performing measurements, allows for adding ballast to vehicles if needed, and adds clarifying procedures for testing on oval tracks. These changes, which align with current practice for light-duty vehicles, will have no substantial effect for measurements with heavy-duty vehicles. We are therefore applying the updated version of SAE J2263 for all light-duty and heavy-duty vehicles. After consideration of comments, we have changed the final rule to make the new test specifications optional through model year 2025.

- *Section 1066.420*: Adding the existing 40 CFR 86.140–94 requirement to zero and span calibrate the hydrocarbon analyzer by overflowing the zero and span gas at the

hydrocarbon sampling system probe inlet during analyzer calibration when testing vehicles that are 14,000 GVWR or less. This requirement was inadvertently missed during the migration of the light-duty test procedures to 40 CFR part 1066. After consideration of comments, the final rule revises the proposal by reducing the HC contamination limit in 40 CFR 1066.420(b)(1)(iii) from 2  $\mu\text{mol/mol}$  to 0.5  $\mu\text{mol/mol}$  for vehicles at or below 14,000 pounds GVWR with compression-ignition engines.

- *Section 1066.831*: Removing the reference to 40 CFR part 1065 regarding how to measure THC emissions, as the method for measuring THC emission is already covered in 40 CFR part 1066, subparts B and E.

This final rule includes additional amendments that are regarded as clarifications in the following sections of 40 CFR parts 1036, 1037, 1065, and 1066 (as numbered in this final rule): 40 CFR 1036.501, 1036.505, 1036.510, 1036.512, 1036.520, 1036.535, 1036.540, 1036.543, and 1036.550; 40 CFR 1037.320, 1037.510, 1037.515, 1037.520, 1037.534, 1037.540, 1037.550, 1037.551, 1037.555, 1037.601, 1037.615, and 1037.725; 40 CFR 1065.1, 1065.5, 1065.10, 1065.12, 1065.140, 1065.145, 1065.190, 1065.210, 1065.284, 1065.301, 1065.305, 1065.307, 1065.308, 1065.309, 1065.315, 1065.320, 1065.325, 1065.330, 1065.345, 1065.350, 1065.410, 1065.501, 1065.510, 1065.512, 1065.514, 1065.530, 1065.543, 1065.545, 1065.610, 1065.630, 1065.650, 1065.655, 1065.660, 1065.667, 1065.670, 1065.675, 1065.680, 1065.695, 1065.715, 1065.720, 1065.790, 1065.901, 1065.915, 1065.920, 1065.1001, and 1065.1005; and 40 CFR 1066.110, 1066.220, 1066.301, 1066.415, 1066.420, 1066.710, 1066.815, 1066.835, 1066.845, 1066.1001, and 1066.1005.

See Section 14 through 16 of the Response to Comments for a discussion of comments related to engine and vehicle testing provisions.

## 6. Vanadium-Based SCR Catalysts

In certain diesel engine applications vanadium-based SCR catalysts may provide a performance and cost advantage over other types of catalysts. However, vanadium material can sublime from the catalyst in the presence of high exhaust gas temperatures.<sup>584</sup> Sublimation of vanadium catalyst material leads to reduced NO<sub>x</sub> conversion efficiency of the catalyst and possible exposure of the public to vanadium emissions. In 2016

EPA provided certification guidance to manufacturers of diesel engines equipped with vanadium-based SCR catalysts (“2016 guidance”).<sup>585</sup> The certification guidance clarified EPA’s expectations for manufacturers using vanadium-based SCR catalysts and provided our views and recommendations on reasonable steps manufacturers can take to protect against excessive loss of vanadium from these SCR systems. We are now codifying these provisions as regulatory requirements for using vanadium-based SCR catalysts. We are adopting these requirements for all types of highway and nonroad diesel engines. The regulatory provisions are consistent with the 2016 guidance and will begin to apply when the final rule becomes effective. To facilitate this direct implementation for 2026 and earlier model years, we are updating 40 CFR 86.007–11 to reference the new 40 CFR 1036.115(g)(2), which contains the requirements related to vanadium-based SCR catalysts.

To meet the new requirements, manufacturers of engines equipped with vanadium-based SCR catalysts must determine vanadium sublimation temperatures and thermal management strategies and include documentation in their certification applications. EPA will use the information submitted by manufacturers in evaluating a manufacturer’s engine and aftertreatment design as part of the application for certification. Note that the certification requirements described in this section for manufacturers apply equally to anyone certifying remanufactured engines or associated remanufacturing systems where such certification is required.

In their certification applications, engine manufacturers must provide information identifying the vanadium sublimation temperature threshold for the specific catalyst product being used. To identify the vanadium sublimation temperature, manufacturers must use the vanadium sublimation sampling and analytical test method we are adopting in 40 CFR part 1065, subpart L, which is consistent with the procedures identified in the 2016 guidance.<sup>586</sup> Manufacturers must also identify their thermal management strategy that prevents exhaust gas temperatures from exceeding the vanadium sublimation temperature. In addition, manufacturers

<sup>583</sup> “Determination and Use of Vehicle Road-Load Force and Dynamometer Settings”, EPA Guidance Document CD–15–04, February 23, 2015.

<sup>584</sup> The temperature at which vanadium sublimation occurs varies by engine and catalyst and is generally 550 °C or higher.

<sup>585</sup> “Certification of Diesel Engines Equipped with Vanadium-based SCR Catalyst”, EPA guidance document CD–16–09, June 13, 2016.

<sup>586</sup> EPA is adopting the test method from CD–16–09 in 40 CFR part 1065, subpart L; 40 CFR 1065.12 describes the process for approving alternative test procedures.

must identify how their thermal management strategy will protect the catalyst in the event of high-temperature exotherms resulting from upstream engine component failures, as well as exotherms resulting from hydrocarbon buildup during normal engine operation. EPA expects to approve applications describing thermal management strategies that prevent exhaust gas temperatures from exceeding the vanadium sublimation temperature.

Commenters noted that the unit of measure for the method detection limit should be a volume-normalized concentration for a gaseous sample, rather than a solid mass volume, as this will address concerns with the variable impact of dilution effect based on sample size. We are finalizing a recommended method detection limit of 15  $\mu\text{g}/\text{m}^3$  based on a target mass-based method detection limit of 2 ppm, a 60 g capture bed mass, a 0.0129 L (1" long x 1" diameter core) catalyst volume, an SV of 35,000  $\text{s}^{-1}$ , and an 18-hour test duration. We also agree that the units in EPA guidance document CD-16-09 are inaccurate and reflect a typographical error, and that the units should be in  $\mu\text{g}$  instead of pg to reflect a detection limit of ppm.

If a manufacturer is interested in pursuing another means to determine the vanadium sublimation threshold, for example by performing an engine dynamometer-based test utilizing the full production aftertreatment system, they may request the approval of alternative vanadium sublimation test procedures as described in current 40 CFR 1065.10(c)(7).

#### 7. ULSD-Related Exemption for Guam

EPA's in-use fuel requirements at 40 CFR part 1090 include an exemption from the 15-ppm sulfur standard for Guam, American Samoa, and the Commonwealth of the Northern Mariana Islands (40 CFR 1090.620). Diesel fuel meeting the 15-ppm standard is known as ultra-low sulfur diesel or ULSD. EPA's emission standards for highway and nonroad diesel engines generally involves SCR as a control technology. The durability of SCR systems depends on the use of fuel meeting the 15-ppm ULSD standard, so we adopted a corresponding exemption from the most stringent emission standards for engines used in these three territories (see 40 CFR 86.007-11(f) for heavy-duty highway engines and 40 CFR 1039.655 for land-based nonroad diesel engines).

Guam has in the meantime adopted rules requiring the 15-ppm sulfur standard for in-use diesel fuel for both highway and nonroad engines and

vehicles. As a result, there is no longer a reason to keep the exemption from emission standards for engines used in Guam. We are therefore removing the exemption for these engines in Guam. In response to manufacturers' request for time to work through supply and inventory logistics, the final rule removes the Guam exemption effective January 1, 2024.

We are not aware of American Samoa and the Northern Mariana Islands adopting ULSD requirements and we are therefore not removing the exemption for those territories in this final rule.

We are also clarifying that the exemption for land-based nonroad diesel engines at 40 CFR 1039.655 applies only for engines at or above 56 kW. Smaller engines are not subject to  $\text{NO}_x$  standards that would lead manufacturers to use SCR or other sulfur-sensitive technologies, so we do not expect anyone to be using this exemption for engines below 56 kW in any area where the exemption applies. We note that Guam's 15-ppm sulfur standard for in-use diesel fuel is now identical to EPA's 15-ppm diesel fuel sulfur standards in 40 CFR part 1090 and as such could not be preempted under CAA section 211(c)(4)(A)(ii). We intend to revisit the exemption from the Federal 15-ppm ULSD standard for diesel fuel in Guam under 40 CFR part 1090 in a future action. Removing the Federal exemption for diesel fuel in Guam would likely involve new or revised regulatory provisions for parties that make, distribute, and sell diesel fuel in Guam such as additional reporting, recordkeeping, and other compliance-related provisions.

#### 8. Deterioration Factors for Certifying Nonroad Engines

Section IV describes an approach for manufacturers of heavy-duty highway engines to establish deterioration factors (DFs) based on bench-aged aftertreatment in combination with a plan for testing in-use engines to verify that the original deterioration factor properly predicts an engine's emission levels at the end of the useful life. As described in Section IV.F, we are adopting the new approach for establishing deterioration factors to take advantage of available techniques for bench-aging aftertreatment devices to streamline the certification and product-development timeline. The leaner up-front testing can be complemented by measurements from in-use engines to verify that the original deterioration factors are still appropriate for certifying engines in later model years.

This same dynamic applies for nonroad applications. We are therefore

adopting amendments to allow manufacturers of all types of nonroad diesel engines and manufacturers of land-based nonroad spark-ignition engines above 19 kW to use these same procedures to establish and verify DFs. These amendments apply for 40 CFR parts 1033, 1039, 1042, and 1048. We are not adopting any changes to the existing certification and durability procedures for these nonroad engines if the manufacturer does not rely on the new DF verification protocol.

Most of the new DF verification procedures for heavy-duty highway engines apply equally for nonroad engines, but unique aspects of each certification program call for making the following adjustments:

- Marine and land-based nonroad diesel engines are subject to not-to-exceed standards and corresponding test procedures that will continue to apply instead of the in-use measurement protocols adopted in this rule for heavy-duty highway engines.

- Land-based nonroad spark-ignition engines above 19 kW (Large SI engines) are subject to field-testing standards and corresponding test procedures that will continue to apply instead of the in-use measurement protocols adopted in this rule for heavy-duty highway engines.

- Locomotives are not subject to off-cycle emission standards or emission measurement procedures that apply during normal in-use operation. However, manufacturers can perform in situ testing on in-use locomotives that meets all the specifications for certification testing in a laboratory. This allows for testing in-use engines to verify that deterioration factors based on bench-aged aftertreatment devices are appropriate for predicting full-life emissions.

- Each type of nonroad diesel engine already has sector-specific methods for calculating infrequent regeneration adjustment factors.

We are not adding the option to use this approach for certifying recreational vehicles, land-based nonroad spark-ignition engines at or below 19 kW, or marine spark-ignition engines. These engines are generally subject to certification of a useful life that is much shorter than the values that apply for the types of engines for which we are adding the option to use the new DF verification protocol. Many nonroad spark-ignition engines are also certified without aftertreatment. As a result, it is not clear that manufacturers of these other types of engines would find a benefit of using the new DF verification procedures.

We are adopting the proposed changes without modification. See

Section 30.4 of the Response to Comments for a discussion of the comments submitted regarding deterioration factors for nonroad engines.

*B. Heavy-Duty Highway Engine and Vehicle Emission Standards (40 CFR Parts 1036 and 1037)*

1. Timing of Annual Reports

We are adopting amendments to simplify annual reporting requirements to account for the extensive information submissions related to the greenhouse gas emission standards. Vehicle manufacturers are required to report on GEM results and production volumes for thousands of distinct vehicle configurations at the end of the model year to show that emission credits related to calculated average CO<sub>2</sub> emission rates are sufficient to comply with standards. The regulation currently requires an interim end-of-year report by March 31 and a final report by September 30 (see 40 CFR 1037.730). This same schedule is typical for documentation related to emission credits for various types of nonroad engines and vehicles. In contrast to those nonroad programs, compliance with the heavy-duty highway CO<sub>2</sub> emission standards relies on a detailed assessment of GEM results and corresponding production volumes to determine all the necessary credit calculations for the model year. We are amending 40 CFR 1037.730 to no longer require the interim end-of-year report, because we have observed that manufacturers need more time to complete their effort to fully document their compliance for the model year and we believe the interim end-of-year report is unnecessary for heavy-duty vehicles. The regulation allows us to waive this interim report, and we have routinely approved such requests. We are not adopting any change to the content of the final report due in September and will continue to rely on that final report to evaluate compliance with standards.

Engine manufacturers generate and use emission credits based on production volumes that correspond to the vehicle production. As a result, it is beneficial for both EPA and engine manufacturers to align the emission credit reporting requirements for engines and vehicles. We are therefore amending 40 CFR 1036.730 to also omit the interim end-of-year report and instead rely only on the final report submitted by September 30 following each model year. In addition, the regulations at 40 CFR 1036.250 and 1037.250 currently specify that engine

and vehicle manufacturers must report their production volumes within 90 days after the end of the model year. For the same reasons given for modifying the schedule for credit reports, we are aligning this production reporting with the final ABT report, requiring manufacturers to report their production volumes also by September 30 following the end of the model year.

We received no comments on these proposed amendments for credit reporting and are finalizing the proposed changes without modification.

2. Scope and Timing for Amending Applications for Certification

Engines must be produced in a certified configuration to be covered by the certificate of conformity. Manufacturers routinely need to amend their applications for certification during the model year to reflect ongoing product development. These amendments may involve new configurations or improvements to existing configurations. The current regulations describe how manufacturers can make these amendments in a way that allow them to comply with the general requirement to produce engines that are in a certified configuration (see 40 CFR 1036.225 and 1037.225). We generally refer to these amendments as running changes. Manufacturers apply these running changes to new engines they continue to build during the model year. Applying these running changes to engines that have already been produced is referred to as a “field fix”. We have provided “field-fix” guidance since the earliest days of EPA emission standards.<sup>587</sup>

We recently adopted regulatory provisions in 40 CFR parts 1036 and 1037 to describe how manufacturers may modify engines as reflected in the modified application for certification, which included essential elements of the 1975 field-fix guidance (80 FR 73478, October 25, 2016).

There is also a related field-fix question of how to allow for design changes to produced engines (before or after initial shipment) that the manufacturer identifies after the end of the model year. The preamble for that recent final rule explained that the regulatory provisions also included how manufacturers may amend an application for certification after the end of the model year to support intended modifications to in-use engines.

After further consideration, we are revising 40 CFR 1036.225 and 1037.225

to limit manufacturers to having the ability to amend an application for certification only during the production period represented by the model year. These revisions apply starting with the effective date of the final rule. Manufacturers can continue to apply field fixes to engines they have already produced if those engine modifications are consistent with the amended application for certification.

The process for amending applications for certification under 40 CFR 1036.225 and 1037.225 does not apply for field fixes that the manufacturer identifies after the end of the model year. Like our approach in other standard-setting parts for nonroad applications, we refer manufacturers to the 1975 field-fix guidance for recommendations on how to approach design changes after the end of the model year. EPA’s certification software is already set up to accommodate manufacturers that submit documentation for field fixes related to engine families from earlier model years. We believe this approach is effective, and it involves less burden for EPA implementation than allowing manufacturers to amend their application for certification after the end of the model year.

We received no comments on the proposed provisions related to amending applications for certification and are finalizing the proposed changes without modification.

We expect to propose further regulatory provisions in a future rulemaking to update and clarify implementation of the field-fix policy for design changes that occur after the end of the model year. We expect that rulemaking to include consideration of such provisions for all types of highway and nonroad engines and vehicles.

3. Alternate Standards for Specialty Vehicles

The final rule adopting HD GHG Phase 2 standards for heavy-duty highway engines and vehicles included provisions allowing limited numbers of specialty motor vehicles to have engines meeting alternate standards derived from EPA’s nonroad engine programs (80 FR 73478, October 25, 2016). The provisions applied for amphibious vehicles, vehicles with maximum operating speed of 45 mph or less, and all-terrain vehicles with portal axles. The provisions also apply for hybrid vehicles with engines that provide energy for a Rechargeable Energy Storage System, but only through model year 2027.

We continue to recognize the need for and benefit of alternate standards that

<sup>587</sup> “Field Fixes Related to Emission Control-Related Components,” EPA Advisory Circular, March 17, 1975.

address limitations associated with specialty vehicles. We are therefore, as proposed, migrating these alternate standards from 40 CFR 86.007–11 and 86.008–10 into 40 CFR 1036.605 without modification. See section 29.1 of the Response to Comments for a discussion of the comment submitted regarding alternate standards for specialty vehicles.

We are mindful of two important regulatory and technological factors that may lead us to revise the alternate standards for specialty vehicles in a future rulemaking. First, certifying based on powertrain testing addresses the testing limitations associated with nonstandard power configurations. Second, emission control technologies may support more stringent alternate emission standards than the current nonroad engine standards. Furthermore, CARB has not adopted that same approach to apply alternate standards for specialty vehicles and we are unaware of manufacturers certifying any of these types of specialty vehicles to the full engine and vehicle standards.

#### 4. Additional Amendments

We are amending 40 CFR parts 1036 and 1037 to describe units for tire rolling resistance as newtons per kilonewton (N/kN) instead of kg/tonne. SAE J2452 treats these as interchangeable units, but ISO 28580, which we incorporated by reference at 40 CFR 1037.810, establishes N/kN as the appropriate units for measuring rolling resistance. Since the units in the numerator and denominator cancel each other out either way, this change in units has no effect on the numerical values identified in the regulation or on data submitted by manufacturers.

The regulation at 40 CFR 1037.115(e) describes how manufacturers demonstrate that they meet requirements related to air conditioning leakage. Paragraph (e) allows for alternative demonstration methods where the specified method is impossible or impractical, but limits that alternative to systems with capacity above 3000 grams of refrigerant. We recognize alternative demonstrations may also be necessary for systems with smaller capacity and are therefore removing this qualifying criterion. This change is also consistent with amendments CARB adopted in the Omnibus rule.<sup>588</sup>

<sup>588</sup> California Air Resources Board, “Appendix B–3 Proposed 30-Day Modifications to the Greenhouse Gas Test Procedures”, May 5, 2021. Available online: <https://ww2.arb.ca.gov/sites/default/files/barcu/regact/2020/hdomnibuslownox/30dayappb3.pdf>, page 20.

The SET duty cycle specified in 40 CFR 86.1362 contains the engine speed and load as well as vehicle speed and road grade to carry out either engine or powertrain testing. The table defining the duty cycle contains two errors in the vehicle speed column for modes 1a and 14. The vehicle speed is set to “warm idle speed” in the table, which is an engine test set point. Since this is an idle mode and the vehicle is not moving, the vehicle speeds should be set to 0 mi/hr. This correction will have no effect on how powertrain testing over this duty cycle is carried out.

We are correcting a typo in 40 CFR 1036.235(c)(5)(iv)(C) regarding EPA’s confirmatory testing of a manufacturer’s fuel map for demonstrating compliance with greenhouse gas emission standards. We are changing the reference to “greater than or equal to” and instead saying “at or below” to be consistent with the related interim provision in 40 CFR 1036.150(q). The intent of the EPA testing is to confirm that the manufacturer-declared value is at or below EPA’s measured values.

We are clarifying that “mixed-use vehicles” qualify for alternate standards under 40 CFR 1037.105(h) if they meet any one of the criteria specified in 40 CFR 1037.631(a)(1) or (2). In contrast, vehicles meeting the criterion in 40 CFR 1037.631(a)(1) and at least one of the criteria in 40 CFR 1037.631(a)(2) automatically qualify as being exempt from GHG standards under 40 CFR part 1037.

We are amending 40 CFR 1036.250(a) to clarify that engine manufacturers’ annual production report needs to include all engines covered by EPA certification, which includes total nationwide production volumes. We inadvertently used the term “U.S.-directed production volume”, which we define in 40 CFR 1036.801 to exclude engines certified to state emission standards that are different than EPA emission standards. That exclusion applies only for emission credit calculations under 40 CFR part 1036, subpart H, and reports under the ABT program. Manufacturers typically already report nationwide production volumes in their reports under 40 CFR 1036.250(a), so this change will have little or no impact on current certification practices.

We received no comments on the proposed amendments described in this section and are finalizing the proposed changes without modification.

#### C. Fuel Dispensing Rates for Heavy-Duty Vehicles (40 CFR Parts 80 and 1090)

EPA adopted a regulation limiting the fuel dispensing rate to a maximum of 10

gallons per minute for gasoline dispensed into motor vehicles (58 FR 16002, March 24, 1993). The dispensing limit corresponded with the test procedure for vehicle manufacturers to demonstrate compliance with a refueling spitback standard adopted in the same final rule. Spitback involves a spray of liquid fuel during a refueling event if the vehicle cannot accommodate the flow of fuel into the fuel tank. The spitback standard applied only for vehicles at or below 14,000 pounds GVWR, so we provided an exemption from the dispensing limit for dispensing pumps dedicated exclusively to heavy-duty vehicles (see 40 CFR 80.22(j) and 1090.1550(b)). Just like for spitback testing with vehicles at or below 14,000 pounds GVWR, vehicles designed with onboard refueling vapor recovery systems depend on a reliable maximum dispensing rate to manage vapor flow into the carbon canister.

Now that we are adopting a requirement for all gasoline-fueled heavy-duty highway vehicle manufacturers to comply with refueling standards, it is no longer appropriate to preserve the exemption from the dispensing rate limit for dispensing pumps dedicated exclusively to heavy-duty vehicles. Retail stations and fleets rarely have dispensing pumps that are dedicated to heavy-duty vehicles. Since there are no concerns of feasibility or other issues related to meeting the 10 gallon per minute dispensing limit, we are removing the exemption upon the effective date of the final rule.

We received no adverse comments on these proposed amendments related to in-use gasoline dispensing rates and are finalizing the proposed changes without modification.

We note that existing dispensing rate limits relate only to gasoline-fueled motor vehicles. There is no rate restriction on dispensing diesel fuel into motor vehicles, or on dispensing any kind of fuel into aircraft, marine vessels, other nonroad equipment, or portable or permanently installed storage tanks. We are also not adopting new dispensing rate limits for these fuels in this action.

#### D. Refueling Interface for Motor Vehicles (40 CFR Parts 80 and 1090)

We proposed to remove the filler-neck restriction in 40 CFR 80.24. The proposal included a decision not to migrate that restriction to 40 CFR part 86, subpart S, for chassis-certified motor vehicles. Commenters highlighted the continued commercial and regulatory need for EPA to keep the requirement for engine manufacturers to standardize the size of the filler-necks orifice for

gasoline-fueled vehicles. We are therefore moving the filler-neck requirement from 40 CFR 80.24 to 40 CFR 86.1810–17 without changing the substantive requirement. See Section 31.2 of the Response to Comments. This requirement applies for vehicles with gross vehicle weight rating up to 14,000 pounds. We are including no lead time for this requirement because it is consistent with the requirement from 40 CFR 80.24.

#### *E. Light-Duty Motor Vehicles (40 CFR Parts 85, 86, and 600)*

EPA's emission standards, certification requirements, and fuel economy provisions for light-duty motor vehicles are in 40 CFR part 85, 40 CFR part 86, subpart S, and 40 CFR part 600.

##### 1. Testing With Updated Versions of SAE J1634

###### i. Existing BEV Test Procedures

EPA's existing regulations for testing Battery Electric Vehicles (BEVs) can be found in 40 CFR part 600—Fuel Economy and Greenhouse Gas Emissions of Motor Vehicles. The existing EPA regulations (40 CFR 600.116–12(a) and 600.311–12(j) and (k)) reference the 2012 version of the SAE Standard J1634—Battery Electric Vehicle Energy Consumption and Range Test Procedure.

Current regulations (40 CFR 600.116–12(a)) allow manufacturers to perform either single cycle tests (SCT) or the multi-cycle test (MCT) as described in the EPA regulations and the 2012 version of SAE J1634. The SCT and MCT are used to determine the unrounded and unadjusted city and highway range values and the city and highway mile per gallon equivalent (MPGe) fuel economy values.

The 2012 version of SAE J1634 specifies 55 miles per hour (mph) as the speed to be used during the mid-test and end-of-test constant-speed cycles of the MCT. The 2017 version of SAE J1634 specifies 65 mph as the speed to be used during the constant-speed cycles of the MCT. Manufacturers have reached out to the Agency and requested to use the 2017 version of SAE J1634 to reduce the time required to perform the MCT and the Agency has generally approved these requests. EPA's fuel economy regulations allow manufacturers to use procedures other than those specified in the regulations. The special test procedure option is described in 40 CFR 600.111–08(h). This option is used when vehicles cannot be tested according to the procedures in the EPA regulations or when an alternative procedure is

determined to be equivalent to the EPA regulation.

EPA regulations found in 40 CFR 600.210–12(d)(3) specify three options for manufacturers to adjust the unrounded and unadjusted 2-cycle (city and highway) results for fuel economy labeling purposes. The three methods include: Generating 5-cycle data; multiplying the 2-cycle values by 0.7; and asking the Administrator to approve adjustment factors based on operating data from in-use vehicles. To date the Agency has not approved any requests to use operating data from in-use vehicles to generate an adjustment factor.

Many manufacturers use the option to multiply their 2-cycle fuel consumption and range result by the 0.7 adjustment factor. The benefit of this option for the manufacturer is that the manufacturer does not need to perform any of the additional 5-cycle tests to determine the label result. This method is equivalent to the derived 5-cycle method which allows manufacturers to adjust their 2-cycle fuel economy test results for gasoline vehicles based on the EPA determined slope and intercept values generated from 5-cycle testing performed on emission data vehicles (EDVs).

A few manufacturers have been using the option to generate 5-cycle data which is then used for determining a 5-cycle adjustment factor. The specific 5-cycle adjustment factor is then multiplied by the unrounded, unadjusted 2-cycle results to determine fuel economy label values.

EPA's current regulations do not specify a method for performing 5-cycle testing for BEVs. EPA acknowledged this in the 2011 rulemaking that created the fuel economy label requirement for BEVs:

The 5-cycle testing methodology for electric vehicles is still under development at the time of this final rule. This final rule will address 2-cycle and the derived adjustments to the 2-cycle testing, for electric vehicles. As 5-cycle testing methodology develops, EPA may address alternate test procedures. EPA regulations allow test methods alternate to the 2-cycle and derived 5-cycle to be used with Administrator approval. (76 FR 39501, July 6, 2011)

The first manufacturer to approach EPA and request to perform 5-cycle testing for BEVs was Tesla, and EPA approved Tesla's request. The method Tesla proposed is known as the BEV 5-cycle adjustment factor method, and it was added to Appendices B and C of the SAE J1634 Standard in the 2017 update.

Since publication of the 2017 version of SAE J1634, BEV manufacturers in addition to Tesla have been approaching the Agency and seeking to use the 5-cycle adjustment factor methodology outlined in Appendices B and C. EPA has generally approved manufacturer requests to use this method.

The 5-cycle method outlined in the 2017 version of SAE J1634 is essentially the same method that EPA uses to determine 5-cycle fuel economy for vehicles with internal combustion engines. There are, however, two differences between the EPA approved BEV 5-cycle adjustment factor method compared to the 5-cycle calculation methodology outlined in 40 CFR 600.114–12, Vehicle-specific 5-cycle fuel economy and carbon-related exhaust emission calculations. The first difference is that the numerator of the City and Highway fuel economy equations is 0.92 rather than 0.905. This was done to remove the ethanol correction from the 5-cycle fuel economy equation for BEVs. The second change was to allow BEV manufacturers to use the results of a full charge depleting Cold Temperature Test Procedure (CTTP or 20 °F FTP) in the City fuel economy calculation when calculating the running fuel consumption. Vehicles with internal combustion engines (ICE) use only the bag 2 and bag 3 fuel economy results from the CTTP. The CTTP is performed at an ambient temperature of 20 °F after the vehicle has cold-soaked in the 20 °F test chamber for a minimum of 12 hours and a maximum of 36 hours. In addition, to reduce the testing burden the current BEV 5-cycle procedure allows manufacturers to skip the 10-minute key-off soak between UDSS cycles after the second UDSS cycle. This test procedure allowance was made to reduce the time burden for performing full charge depletion testing in the cold test chamber.

###### ii. Summary of Changes

The final rule amends the revisions to § 600.116–12(a) and §§ 600.311–12(j)(2) and 600.311–12(j)(4)(i).

EPA is adopting the proposal to update the SAE J1634 standard referenced in 40 CFR part 600 from the 2012 version to the 2017 version. This update will require manufacturers to use 65 mph for the constant-speed cycles of the MCT. In addition, this update will allow manufacturers to use the BEV 5-cycle adjustment factor methodology outlined in Appendices B and C of the 2017 version of SAE J1634 with the revisions described in this section.



EPA received comments requesting the Agency adopt the 2021 version of SAE J1634. The 2021 version of SAE J1634 includes several additional test procedure changes not included in the 2017 version. Updates for the 2021 version include the development of additional test procedures including the shortened multi-cycle test (SMCT) and the shortened multi-cycle test plus (SMCT+); and, the capability to precondition the BEV prior to performing any of the test procedures, including the 20 °F UDDS, also known as the cold temperature test procedure (CTTP).

At this time the Agency is not prepared to adopt the 2021 version of SAE J1634 with these additional test procedures and pre-conditioning process. The Agency is evaluating the new test procedures (SMCT and SMCT+) to ensure they produce results equivalent to those generated using the existing SCT and MCT test procedures. In addition, the Agency is assessing the use of pre-conditioning the battery and cabin of BEVs prior to performing tests. The Agency is not prepared to adopt preconditioning for BEVs during the soak period prior to starting the drive cycle for the CTTP. The intent of the 12 to 36 hour cold soak period prior to the start of the drive cycle for the CTTP is to stabilize the vehicle and its components at 20 °F prior to starting the driving portion of the test. While BEVs have technology and have operating modes that allow the battery and cabin to be preconditioned while the vehicle is soaking, for this technology to function the vehicle must have access to a dedicated EVSE and the operator must enable this operation. The Agency does not expect that a predominance of BEVs will have access to a dedicated EVSE while the vehicle is 'cold soaking' prior to many cold starts and that the operator will have enabled the preconditioning mode during the soak period. Therefore, the Agency is not adopting the 2021 version of SAE J1634 in this final rule.

EPA proposed for model year 2023, that manufacturers could continue to perform full charge depletion testing on BEVs when running the CTTP to determine the 5-cycle adjustment factor. However, EPA proposed requiring in model year 2023 that manufacturers perform a 10-minute key-off soak between each UDDS cycle as part of the charge depleting CTTP. The Agency has decided not to adopt this proposal based on stakeholder comments and the effort required to update test cells for a procedural change which would only be in effect for one model year.

We are not changing the existing requirement to submit a written request for EPA approval to perform 5-cycle

testing prior to beginning 5-cycle adjustment procedure testing. Manufacturers must attest that the vehicle was not preconditioned or connected to an external power source during the 20 °F cold soak period.

The Agency proposed requiring manufacturers to perform only two UDDS cycles when running the CTTP, with a 10-minute key-off soak between the UDDS cycles to generate their BEV 5-cycle adjustment factor beginning in model year 2024. The Agency is adopting this proposal and is delaying the start from model year 2024 to the 2025 based on comments received from stakeholders and the timing of the final rulemaking. The running fuel consumption for the City fuel economy equation comes from a modified form of the equation provided in Appendix C of the 2017 version of SAE J1634. The charge-depletion value is replaced with the results from Bag 2 of the first and second UDDS and Bag 1 from the second UDDS. Manufacturers may use their existing CTTP test results to make these calculations, or they may perform new tests with the option to select the vehicle's state-of-charge so it can capture regeneration energy during the first UDDS cycle.

EPA is also adopting the following additional changes to the procedures outlined in the 2017 version of SAE J1634:

- Specifying a maximum constant-speed phase time of 1 hour with 5- to 30 minute key-off soak following each one-hour constant-speed phase.
- Specifying the use of the methods in Appendix A of the 2017 version of SAE J1634 to determine the constant-speed cycle's total time for the mid-test constant-speed cycle, or the manufacturer may use a method they developed using good engineering judgment.
- Specifying that energy depleted from the propulsion battery during key-off engine soak periods is not included in the useable battery energy (UBE) measurement.

### iii. Discussion of Changes

The Agency is adopting in this final rule portions of Appendix B and C of the 2017 version of SAE J1634 as the process for determining the 5-cycle adjustment factor with modifications. Manufacturers must request EPA approval to use the process outlined in the Appendices with the following modifications:

- Preconditioning any vehicle components, including the propulsion battery and vehicle cabin, is prohibited.
- Beginning in model year 2025, only two UDDS cycles may be performed on

the CTTP, instead of allowing manufacturers to choose how many UDDS cycles to perform up to and including full charge-depletion testing on the CTTP.

The Agency has concluded not to proceed with the proposal for performing a charge depleting CTTP while requiring a 10-minute key-off soak period between each charge depleting UDDS cycle. The Agency did not intend to force BEV manufacturers to perform all new charge depletion testing for a single model year. As proposed, the change would have created a discrepancy between vehicles tested using the CTTP with only one 10-min key-off soak period between the first and second UDDS and vehicles testing with a 10-min key-off soak period between all UDDS cycles. This would not have been consistent with the Agency's objective of maintaining test procedure consistency for fuel economy labeling. Therefore, this requirement, which had been proposed for only the 2023 model year has been dropped from the final rule.

The current approved 5-cycle test procedure includes allowing a complete charge depleting CTTP to generate data for the city fuel economy calculation. As the Agency has gathered data from manufacturers performing this test, it has become apparent that the charge depletion testing on the CTTP generates fuel consumption data that are not representative of the extreme cold start test conditions this test was designed to capture. A long-range BEV can complete as many as 50 UDDS cycles at -7 °C (20 °F) before depleting the battery. With the allowance to skip the 10-minute key off soak period after the second UDDS a long-range BEV will reach a stabilized warmed-up energy consumption condition after 6 to 10 UDDS cycles. At this point the vehicle is warmed-up and will have approximately the same energy consumption for each of the remaining 30 to 40 UDDS cycles. The averaged energy consumption value from this full charge depletion test—as many as 50 UDDS cycles—is entered into the 5-cycle equation for the running fuel consumption for the city fuel economy calculation. In contrast, for vehicles using fuels other than electricity the running fuel consumption is calculated using the values from Bag 2 of the first UDDS cycle and Bag 1 of the second UDDS cycle.

It has become apparent to the Agency that modifications are needed to this method to ensure all vehicles are tested under similar conditions and use equivalent data for generating fuel economy label values. Allowing BEVs to perform a full charge depletion CTTP

creates test procedure differences between BEVs and non-BEVs. Non-BEVs are not allowed to run more than one UDDS cycle followed by one Bag 1 phase from the second UDDS cycle.

The intent of the CTTTP is to capture the performance of vehicles under extreme cold start conditions during short trip city driving. The CTTTP procedure used by vehicles other than BEVs consists of one UDDS cycle (consisting of Bag 1 and Bag 2) followed by a 10-minute key-off soak followed by the first 505 seconds (Bag 3) of the second UDDS cycle. The data from these

three bags are utilized by all vehicles, other than BEVs, when calculating the vehicle's city fuel economy (40 CFR 600.114–12). Allowing BEVs to use a fuel consumption value based on fully depleting the battery, while not performing any key-off soaks between any UDDS cycle after the second UDDS cycle is not representative of short trip urban driving or equivalent to the procedure performed by vehicles using fuels other than electricity.

Based on these observations, the Agency has concluded that allowing BEVs to perform full charge depletion

testing on the CTTTP, with only one 10-minute key-off soak occurring between the first and second UDDS cycle, does not generate data representative of the vehicles' performance during extreme cold start short trip city driving conditions. Therefore, starting in model year 2025, EPA will allow BEVs to perform only two UDDS cycles with a 10-minute key-off soak between them. The final rule includes the following change to the running fuel consumption equation for calculating the city fuel economy outlined in Appendix C of the 2017 Version of SAE J1634:

$$\begin{aligned} \text{RunningFC} = & 0.82 \times \left[ \frac{0.48}{\text{Bag2 FTP}} + \frac{0.41}{\text{Bag3 FTP}} + \frac{0.11}{\text{US06 City}} \right] \\ & + 0.18 \times \left[ \frac{1}{(20\text{degF UDDS1 Bag2} + 20\text{degF UDDS2 Bag2})} \right. \\ & \left. + \frac{0.5}{20\text{degF UDDS2 Bag1}} \right] \\ & + 0.133 \times 1.083 \times \left[ \frac{1}{\text{SC03}} - \left( \frac{0.61}{\text{Bag3 FTP}} + \frac{0.39}{\text{Bag2 FTP}} \right) \right] \end{aligned}$$

In the proposal, EPA sought comment on whether it was reasonable to perform two UDDS cycles as part of the CTTTP or whether the test should conclude after the first 505 seconds (phase 1) of the second UDDS. The Agency did not receive any comments on this proposal. The Agency did receive comments from stakeholders on related topics:

Requesting the Agency continue to allow full charge depletion testing for the CTTTP; requesting the Agency update to the 2021 version of SAE J1634 which would allow for battery and cabin preconditioning during the CTTTP; and requesting the Agency revise the CTTTP procedure by utilizing a methodology which would stop the CTTTP once the vehicle had reached a stabilized energy consumption rate.

As the Agency did not receive comments on the proposal to limit the CTTTP for BEVs to one UDDS followed by the first phase (505 seconds) of the second UDDS after a 10-minute key-off soak, the Agency is not adopting this proposal.

As noted in the preceding paragraphs, the Agency believes allowing a full charge depleting test during the CTTTP produces data which is not representative of short trip urban driving or equivalent to the procedure performed by vehicles using fuels other than electricity. The intent of the CTTTP is to determine the fuel consumption of vehicles during short trip urban driving following an extended cold soak at

20 °F. Data generated from operating a BEV over an entire charge depleting test does not represent the fuel consumption of the vehicle during the first 2 UDDS cycles. Therefore, the Agency is adopting the proposal to replace the charge depleting CTTTP for BEV 5-cycle testing with a CTTTP consisting of 2 UDDS cycles with a 10-minute key-off soak between the UDDS cycles.

The suggestion to allow preconditioning for BEVs during the CTTTP would result in procedural differences between BEV's and non-BEV CTTTP testing. The intent of the CTTTP is to determine the fuel consumption of the vehicle during a short-trip urban drive following an extended soak at period at 20 °F, with the vehicle and all powertrain components stabilized at 20 °F. While BEVs have technology which will precondition the cabin and battery at cold ambient temperatures, this technology requires access to a dedicated EVSE along with the operator selecting the appropriate mode to enable preconditioning. The Agency does not believe a predominance of cold soaks for BEVs with this technology will occur where the vehicle has access to a dedicated EVSE and the operator will enable the preconditioning mode. The Agency policy with respect to fuel economy testing is for the test procedures (including the soak period prior to beginning a test) be equivalent for all vehicles independent of fuel type. For these reasons the Agency is not

prepared to adopt the preconditioning provisions of the 2021 version of SAE J1634.

The Agency also received a comment proposing to modify the CTTTP by running repeat UDDS cycles until the energy consumption stabilizes. The stabilized energy consumption measured during the last few UDDS cycles, along with the energy consumption measured during the first phase of the first and second UDDS would be used for the 5-cycle adjustment factor calculation. This proposal would reduce the time required to perform the CTTTP as it would be expected that less than 10 UDDS cycles would be required. This proposal would also use the energy consumption value measured after the BEV has driven from 3 to 5 or possibly more UDDS cycles to represent the energy consumption occurring during short trip urban driving. As this procedure uses data taken after the vehicle has driven over twenty miles, these data are not representative of short trip urban energy consumption.

The possibility exists that a BEV manufacturer may decide to consume stored battery energy to precondition the battery depending on the ambient temperature, the battery temperature when the vehicle is parked, and other factors. Using stored battery energy for preconditioning the battery temperature is not addressed in either EPA regulations or SAE J1634. Were a

manufacturer to implement such a strategy, the Agency would expect the energy consumed during the extended cold soak prior to the CTTTP would need to be considered as DC discharge energy. The BEV CTTTP does not require measuring DC discharge energy during the extended cold soak prior to starting the CTTTP drive cycle. It is assumed the BEV goes into sleep mode during the cold soak and consumes minimal to no electrical energy. If such a strategy was implemented the Agency would want the manufacturer to disclose this operation and work with the Agency to determine the appropriate means for accounting for this energy use. The Agency is not aware of any vehicles which, when not plugged into an EVSE, will consume stored energy to maintain the temperature of the battery during extended cold soaks.

The Agency understands the BEV CTTTP test procedure and the 5-cycle fuel economy equation are different from those that apply for non-BEVs. Unlike vehicles using combustion engines, BEVs do not generate significant quantities of waste heat from their operation, and typically require using stored energy, when not being preconditioned at cold ambient temperatures, to produce heat for both the cabin and the battery. The Agency expects BEVs will require more than two UDDS cycles with a 10-minute key-off soak between them for the vehicle to reach a fully warmed up and stabilized operating point. As such, the Agency believes it is reasonable to include an additional data point (*i.e.*, UDDS2 Bag2) for use in the running fuel consumption equation for BEVs.

For model year 2025, manufacturers may recalculate the city fuel economy for models they are carrying-over using the first two UDDS cycles from their prior charge-depletion CTTTP test procedures to generate new model year 2025 label values. Manufacturers might not want to use these data, as the test might not be representative, since the vehicle's regeneration capability may be limited by the fully charged battery during the first and possibly second UDDS cycles on the CTTTP. The manufacturer will be able to determine an appropriate state-of-charge (SoC) and set the battery to that SoC value prior to beginning the cold soak for the CTTTP. The manufacturer will be required to disclose the desired SoC level to the Agency. One possible approach consists of charging the vehicle to a level that produces a battery state-of-charge (SoC) equivalent to 50 percent following the first UDDS cycle. The 2017 version of SAE J1634 refers to this SoC level as the mid-point test charge (MC).

As BEVs have become more efficient and as battery capacities have increased over the past decade, the time required to perform CTTTP charge-depletion testing has dramatically increased. The amendments in this final rule will result in significant time savings for manufacturers as the BEV CTTTP will consist of two UDDS cycles. The test also no longer allows charge-depletion testing, which in many instances would require multiple shifts to complete. The Agency also believes the results obtained from the amended test procedure better represent the energy consumption observed during short urban trips under extreme cold temperature conditions.

Based on stakeholder comments and for model years prior to 2025, the Agency will continue to allow BEV manufacturers to determine the 5-cycle adjustment factor using the methods outlined in Appendices B and C of the 2017 version of SAE J1634. This option is now included in the regulations at § 600.116–12(a)(11).

The Agency has also included the option for manufacturers to use a method developed by the manufacturer, based on good engineering judgment, to determine the mid-test constant speed cycle distance. In the proposal EPA allowed manufacturers to use one of the two methods in Appendix A of SAE J1634 to estimate the mid-test constant speed distance. It is apparent to the Agency that manufacturers will have additional information and prior development testing experience to accurately estimate the mid-test constant speed distance and therefore the Agency is including this as an option in § 600.116–12(a)(4).

The Agency received comments that during the 15 second key-on pause between UDDS1 and HFEDS1 and UDDS3 and HFEDS2, the discharge energy should be measured and included in the UBE measurement and not applied to the HFEDS energy consumption. The Agency agrees with the commentors that the energy consumption should not be applied to the HFEDS cycle as measurement for this cycle starts just prior to the vehicle beginning the drive trace. However, the sampling for the UDDS cycle ends when the drive trace for the UDDS cycle reaches 0 mph. Therefore, the 15 second key-on pause between the UDDS and HFEDS cycle is not included in either the discharge energy consumption for the UDDS or the HFEDS cycle. Since UBE is the summation of the cycle discharge energy and since the key-on pause energy is not included in either cycle values, the energy discharged during this 15-second period is not

included in the UBE. This same criterion applies to the discharge energy that occurs during key-off soak periods as these periods are not measured. This also includes the key-off soak periods between phases of the constant-speed cycles.

The Agency has decided to proceed with requiring 5-minute to 30-minute key-off breaks during constant speed cycles which require more than one-hour to complete. The requirements for determining the breaks are outlined in §§ 600.116–12(a)(5) and 600.116–12(a)(7). The specification for the key-off breaks are based on Section 6.6 of the 2017 version of J1634.

Based on comments and additional review of SAE J1634 the Agency set the key-on pauses and key-off soak periods for the MCT equivalent to the times found in Section 8.3.4 of the 2017 version of SAE J1634. The Agency received comments indicating a maximum key-off pause time needed to be set in the instances where the Agency had previously only provided a minimum key-off time. The Agency has set the key-off pause times equivalent to the pause times specified in SAE J1634 in Section 6.6 and Section 8.3.4.

#### iv. Changes to Procedures for Testing Electric Vehicles

EPA is updating the regulation from the 2012 version of SAE J1634 to instead reference the 2017 version of SAE J1634. EPA is also including regulatory provisions that amend or clarify the BEV test procedures outlined in the 2017 version of SAE J1634 in § 600.116–12(a). These amendments are intended to minimize test procedure variations allowed in the 2017 version, which the Agency has concluded can impact test results. For example, the SAE standard allows for the constant-speed cycles to be performed as a single phase or broken into multiple phases with key-off soak periods. Depending on how the constant-speed portion is subdivided, the UBE measurement can vary. The regulatory amendments are intended to reduce the variations between tests and to improve test-to-test and laboratory-to-laboratory repeatability. This final rule includes the following changes:

- Allowing for Administrator approval for vehicles that cannot complete the Multi-Cycle Range and Energy Consumption Test (MCT) because of the distance required to complete the test or maximum speed for the UDDS or HFEDS cycle in § 600.116–12(a)(1).
- In alignment with SAE J1634, Section 6.6 and Section 8.3.4, key-on pause times and key-off soak times have been set to the same minimum and

maximum values as outlined in SAE J1634 and where key-off soak periods have to be conducted with the key or power switch in the “off” position, the hood closed, and test cell fan(s) off, and the brake pedal not depressed as required in §§ 600.116–12(a)(2), 600.116–12(a)(3), 600.116–12(a)(5), and 600.116–12(a)(7).

- Manufacturers predetermine estimates of the mid-test constant-speed cycle distance (dM) using the methods in SAE J1634, Appendix A or a method developed by the manufacturer using good engineering judgment as required in § 600.116–12(a)(4).

- Mid-test constant-speed cycles that do not exceed one hour do not need a key-off soak period. If the mid-test constant-speed cycle exceeds one hour, the cycle needs to be separated into phases of less than one-hour, and a 5-minute to 30-minute key-off soak is needed at the end of each phase as required in § 600.116–12(a)(5).

- Using good engineering judgment, end-of-test constant-speed cycles do not exceed 20 percent of total distance driven during the MCT, as described in SAE J1634, Section 8.3.3 is required in § 600.116–12(a)(6).

- End-of-test constant-speed cycles that do not exceed one hour do not need a key-off soak period. If the end-of-test constant-speed cycle exceeds one hour, the cycle needs to be separated into phases of less than one-hour, and a 5-minute to 30-minute key-off soak is needed at the end of each phase as required in and 600.116–12(a)(7).

- Recharging the vehicle’s battery must start within three hours after testing as required in § 600.116–12(a)(9).

- The Administrator may approve a manufacturer’s request to use an earlier version of SAE J1634 for carryover vehicles as required in § 600.116–12(a)(10).

- All label values related to fuel economy, energy consumption, and range must be based on 5-cycle testing, or values must be adjusted to be equivalent to 5-cycle results. Manufacturers may request Administrator approval to use SAE J1634, Appendix B and Appendix C for determining 5-cycle adjustment factors as required in § 600.116–12(a)(11).

## 2. Additional Light-Duty Changes Related to Certification Requirements and Measurement Procedures

This final rule includes the following additional amendments related to criteria standards and general certification requirements, which we are finalizing as proposed unless specifically noted otherwise:

- *40 CFR part 85, subpart V:* Correcting the warranty periods identified in the regulation to align with the Clean Air Act, as amended, and clarifying that the warranty provisions apply to both types of warranty specified in CAA section 207(a) and (b)—an emission defect warranty and an emission performance warranty. EPA adopted warranty regulations in 1980 to apply starting with model year 1981 vehicles (45 FR 34802, May 22, 1980). The Clean Air Act as amended in 1990 changed the warranty period for model year 1995 and later light-duty vehicles and light-duty trucks to 2 years or 24,000 miles of use (whichever occurs first), except that a warranty period of 8 years or 80,000 miles applied for specified major emission control components.

- *Section 86.117–96:* Revising paragraph (d)(1), which describes how to calculate evaporative emissions from methanol-fueled vehicles. The equation in the regulation inadvertently mimics the equation used for calculating evaporative emissions from gasoline-fueled vehicles. We are revising the equation to properly represent the fuel-specific calculations in a way that includes temperature correction for the sample volume based on the sample and SHED temperatures. The final rule includes a correction to a typographical error in the equation from the proposed rule.

- *Section 86.143–96:* We are finalizing changes to the equation for calculating methanol mass emissions. A commenter pointed out that this equation is the same as the one we proposed to correct in 40 CFR 86.117–96.

- *Section 86.1810:* Clarifying the certification responsibilities for cases involving small-volume manufacturers that modify a vehicle already certified by a different company and recertify the modified vehicle to the standards that apply for a new vehicle under 40 CFR part 86, subpart S. Since the original certifying manufacturer accounts for these vehicles in their fleet-average calculations, these secondary vehicle manufacturers should not be required to repeat those fleet-average calculations for the affected vehicles. This applies to fleet average standards for criteria exhaust emissions, evaporative emissions, and greenhouse gas emissions. The secondary vehicle manufacturer would need to meet all the same bin standards and family emission limits as specified by the original certifying manufacturer.

- *Section 86.1819–14:* Clarifying that the definition of “engine code” for implementing heavy-duty greenhouse

gas standards (Class 2b and 3) is the same “engine code” definition that applies to light-duty vehicles in the part 600 regulations.

- *Section 86.1823–08:* Revising to specify a simulated test weight based on Loaded Vehicle Weight for light light-duty trucks (LDT1 and LDT2). The regulation inadvertently applies adjusted loaded vehicle weight, which is substantially greater and inappropriate for light light-duty trucks because they are most often used like lightly loaded passenger vehicles rather than cargo-carrying commercial trucks. In practice, we have been allowing manufacturers to implement test requirements for these vehicles based on Loaded Vehicle Weight. This revision is responsive to manufacturers’ request to clarify test weights for the affected vehicles.

- *Section 86.1843–01(f)(2):* Delaying the end-of-year reporting deadline to May 1 following the end of the model year. Manufacturers requested that we routinely allow for later submissions instead of setting the challenging deadline of January 1 and allowing extensions.

We are adopting the following additional amendments related to greenhouse gas emissions and fuel economy testing:

- *Section 86.1823–12:* Revising paragraph (m)(1) to reflect current practices with respect to CO<sub>2</sub> durability requirements. The revisions clarify how certification and testing procedures apply in areas that are not entirely specified in current regulations. The amendments in this final rule reflect the procedures EPA and manufacturers have worked out in the absence of the detailed regulatory provisions. For example, while conventional vehicles currently have a multiplicative CO<sub>2</sub> deterioration factor of one or an additive deterioration factor of zero to determine full useful life emissions for FTP and highway fuel economy tests, many plug-in hybrid electric vehicles have non-zero additive CO<sub>2</sub> deterioration factors (or manufacturers perform fuel economy tests using aged components). These changes have no impact on conventional vehicles, but they strengthen the CO<sub>2</sub> durability requirements for plug-in hybrid electric vehicles. In response to a comment, we are revising the regulation for the final rule to specifically name batteries as one of the aged components to install on a test vehicle, rather than referring generically to “aged components.”

- *Section 600.001:* Clarifying that manufacturers should send reports and requests for approval to Designated

Compliance Officer, which we are defining in 40 CFR 600.002.

- *Section 600.002*: Revising the definition of “engine code” to refer to a “test group” instead of an “engine-system combination”. This change reflects updated terminology corresponding to current certification procedures.

- *Part 600, subpart B*: Updating test procedures with references to 40 CFR part 1066 to reflect the migration of procedures from 40 CFR part 86, subpart B. The migrated test procedures allow us to delete the following obsolete regulatory sections: 600.106, 600.108, 600.109, 600.110, and 600.112, along with references to those sections.

- *Sections 600.115 and 600.210*: EPA issued guidance in 2015 for the fuel economy program to reflect technology trends.<sup>589</sup> We are amending the regulation to include these changes. First, as outlined in the EPA guidance letter and provisions of 40 CFR 600.210–12(a)(2)(iv), “[t]he Administrator will periodically update the slopes and intercepts through guidance and will determine the model year that the new coefficients must take effect.” Thus, we are updating the coefficients used for calculating derived 5-cycle city and highway mpg values in 40 CFR 600.210 to be consistent with the coefficients provided in the 2015 EPA guidance letter and to be more representative of the fuel economy characteristics of the current fleet. Second, for reasons discussed on page 2 of the EPA guidance letter, we are amending 40 CFR 600.115 to allow manufacturers to calculate derived 5-cycle fuel economy and CO<sub>2</sub> emission values using a factor of 0.7 only for battery electric vehicles, fuel cell vehicles, and plug-in hybrid electric vehicles (during charge depleting operation only).

- *Section 600.210*: The regulation already allows manufacturers to voluntarily decrease fuel economy values and raise CO<sub>2</sub> emission values if they determine that the values on the fuel economy label do not properly represent in-use performance. The expectation is that manufacturers would prefer not to include label values that create an unrealistic expectation for consumers. We are adding a condition that the manufacturer may adjust these values only if the manufacturer changes both values and revises any other affected label value accordingly for a model type (including but not limited to the fuel economy 1–10 rating,

greenhouse gas 1–10 rating, annual fuel cost, and 5-year fuel cost information). We are also extending these same provisions for electric vehicles and plug-in hybrid electric vehicles based on both increasing energy consumption values and lowering the electric driving range values.

- *Section 600.311*: Adding clarifying language to reference the adjusted driving ranges to reflect in-use driving conditions. These adjusted values are used for fuel economy labeling. For plug-in hybrid electric vehicles, we are also correcting terminology from “battery driving range” to “adjusted charge-depleting driving range (R<sub>cta</sub>)” for clarity and to be consistent with the terms used in SAE Recommended Practice J1711. The final rule includes adjustments to the wording of the amendments in 40 CFR 600.311 for greater clarity and consistency.

- *Section 600.510–12*: Providing a more detailed cross reference to make sure manufacturers use the correct equation for calculating average combined fuel economy.

- *Section 600.512–12*: Delaying the deadline for the model year report from the end of March to May 1 to align the deadline provisions with the amendment for end-of-year reporting as described in 40 CFR 86.1843–01(f)(2).

See Section 32.2 of the Response to Comments for a discussion of comments related to these amendments for the light-duty program in 40 CFR part 85, 40 CFR part 86, subpart S, and 40 CFR part 600.

Note that we are adopting additional amendments to 40 CFR part 86, subparts B and S, that are related to the new refueling emission standards for heavy-duty vehicles described in section III.E of this preamble.

#### *F. Large Nonroad Spark-Ignition Engines (40 CFR Part 1048)*

EPA’s emission standards and certification requirements for land-based nonroad spark-ignition engines above 19 kW are set out in 40 CFR part 1048. We are adopting the following amendments to part 1048:

- *Section 1048.501*: Correct a mistaken reference to duty cycles in appendix II.

- *Section 1048.620*: Remove obsolete references to 40 CFR part 89.

We received no comments on these proposed amendments and are finalizing the proposed changes without modification.

#### *G. Small Nonroad Spark-Ignition Engines (40 CFR Part 1054)*

EPA’s emission standards and certification requirements for land-

based nonroad spark-ignition engines at or below 19 kW (“Small SI engines”) are set out in 40 CFR part 1054. We recently proposed several amendments to part 1054 (85 FR 28140, May 12, 2020). Comments submitted in response to that proposed rule suggested additional amendments related to testing and certifying these Small SI engines. The following discussion describes several amendments that are responsive to these suggested additional amendments. Otherwise, we are finalizing the provisions as proposed, except as specifically noted.

#### 1. Engine Test Speed

The duty cycle established for nonhandheld Small SI engines consists of six operating modes with varying load, and with engine speed corresponding to typical governed speed for the intended application. This generally corresponds to an “A cycle” with testing at 3060 rpm to represent a typical operating speed for a lawnmower, and a “B cycle” with testing at 3600 rpm to represent a typical operating speed for a generator. While lawnmowers and generators are the most common equipment types, there are many other applications with widely varying speed setpoints.

In 2020, we issued guidance to clarify manufacturers’ testing responsibilities for the range of equipment using engines from a given emission family.<sup>590</sup> We are adopting the provisions described in that guidance document. This includes two main items. First, we are amending the regulation at 40 CFR 1054.801 to identify all equipment in which the installed engine’s governed speed at full load is at or above 3400 rpm as “rated-speed equipment”, and all equipment in which the installed engine’s governed speed at full load is below 3330 rpm as “intermediate-speed equipment”. For equipment in which the installed engine’s governed speed at full load is between 3330 and 3400 rpm, the engine manufacturer may consider that to be either “rated-speed equipment” or “intermediate-speed equipment”. This allows manufacturers to reasonably divide their engine models into separate families for testing only on the A cycle or the B cycle, as appropriate. For emission families including both rated-speed equipment and intermediate-speed equipment, manufacturers must measure emissions over both the A cycle and the B cycle

<sup>589</sup> “Derived 5-cycle Coefficients for 2017 and Later Model Years”, EPA Guidance Document CD–15–15, June 22, 2015.

<sup>590</sup> “Small Spark-Ignition Nonhandheld Engine Test Cycle Selection,” EPA guidance document CD–2020–06, May 11, 2020.

and certify based on the worst-case HC+NO<sub>x</sub> emission results.

Second, we are limiting the applicability of the A cycle to engines with governed speed at full load that is at or above 2700 rpm, and limiting the applicability of the B cycle to engines with governed speed at full load that is at or below 4000 rpm. These values represent an approximate 10 percent variation from the nominal test speed. For engines with governed speed at full load outside of these ranges, we will require that manufacturers use the provisions for special procedures in 40 CFR 1065.10(c)(2) to identify suitable test speeds for those engines. Manufacturers may take reasonable measures to name alternate test speeds to represent multiple engine configurations and equipment installations.

See Section 32.3 of the Response to Comments for a discussion of the comments submitted regarding test selection.

## 2. Steady-State Duty Cycles

As noted in Section XI.G.1, the duty cycle for nonhandheld engines consists of a six-mode duty cycle that includes idle and five loaded test points. This cycle is not appropriate for engines designed to be incapable of operating with no load at a reduced idle speed. For many years, we have approved a modified five-mode duty cycle for these engines by removing the idle mode and reweighting the remaining five modes. We are adopting that same alternative duty cycle into the regulation and requiring manufacturers to use it for all engines that are not designed to idle. For emission families that include both types of engines, manufacturers must measure emissions over both the six-mode and five-mode duty cycles and certify based on the worst-case HC+NO<sub>x</sub> emission results.

We are adopting the proposed changes without modification, except that we are adding a clarifying note to limit the reporting requirement to the worst-case value if a manufacturer performs tests both with and without idle. See Section 32.4 of the Response to Comments.

The discussion in Section XI.G.1 applies equally for nonhandheld engines whether or not they are designed to idle. As a result, if an emission family includes engines designed for idle with governed speeds corresponding to rated-speed equipment and intermediate-speed equipment, and engines in the same emission family that are not designed to idle have governed speeds corresponding to rated-speed equipment and intermediate-

speed equipment, the manufacturer must perform A cycle and B cycle testing for both the six-mode duty cycle and the five-mode duty cycle. Manufacturers would then perform those four sets of emission measurements and certify based on the worst-case HC+NO<sub>x</sub> emission results.

The nonhandheld six-mode duty cycle in appendix II to 40 CFR part 1054 includes an option to do discrete-mode or ramped-modal testing. The ramped-modal test method involves collecting emissions during the established modes and defined transition steps between modes to allow manufacturers to treat the full cycle as a single measurement. However, no manufacturer has ever used ramped-modal testing. This appears to be based largely on the greater familiarity with discrete-mode testing and on the sensitivity of small engines to small variations in speed and load. Rather than increasing the complexity of the regulation by multiplying the number of duty cycles, we are removing the ramped-modal test option for the six-mode duty cycle.

## 3. Engine Family Criteria

Manufacturers requested that we allow open-loop and closed-loop engines to be included together in a certified emission family, with the testing demonstration for certification based on the worst-case configuration.

The key regulatory provision for this question is in 40 CFR 1054.230(b)(8), which says that engine configurations can be in the same emission family if they are the same in the “method of control for engine operation, other than governing (mechanical or electronic)”.

Engine families are intended to group different engine models and configurations together if they will have similar emission characteristics throughout the useful life. The general description of an engine’s “method of control for engine operation” requires that EPA apply judgment to establish which fuel-system technologies should be eligible for treating together in a single engine family. We have implemented this provision by allowing open-loop and closed-loop engine configurations to be in the same emission family if they have the same design values for spark timing and targeted air-fuel ratio. This approach allows us to consider open-loop vs. closed-loop configurations as different “methods of control” when the engines have fundamentally different approaches for managing combustion. We do not intend to change this current practice and we are therefore not amending 40 CFR 1054.230 to address

the concern about open-loop and closed-loop engine configurations.

The existing text of 40 CFR 1054.230(b)(8) identifies “mechanical or electronic” control to be fundamental for differentiating emission families. However, as is expected for open-loop and closed-loop configurations, we expect engines with electronic throttle-body injection and mechanical carburetion to have very similar emission characteristics if they have the same design values for spark timing and targeted air-fuel ratio. A more appropriate example to establish a fundamental difference in method of control is the contrast between port fuel injection and carburetion (or throttle-body injection). We are therefore revising the regulation with this more targeted example. This revision allows manufacturers to group engine configurations with carburetion and throttle-body injection into a shared emission family as long as they have the same design values for spark timing and targeted air-fuel ratio.

We are adopting the proposed changes without modification. See Section 32.5 of the Response to Comments for a discussion of the comments submitted regarding engine family criteria.

## 4. Miscellaneous Amendments for Small Nonroad Spark-Ignition Engines

We are adopting the following additional amendments to 40 CFR part 1054:

- *Section 1054.115*: Revising the description of prohibited controls to align with similar provisions from the regulations that apply for other sectors.
- *Section 1054.505(b)(1)(i)*: Correcting typographical errors.
- *Appendix I*: Clarifying that requirements related to deterioration factors, production-line testing, and in-use testing did not apply for Phase 1 engines certified under 40 CFR part 90.

We received no comments on these proposed provisions and are finalizing the proposed changes without modification.

### *H. Recreational Vehicles and Nonroad Evaporative Emissions (40 CFR Parts 1051 and 1060)*

EPA’s emission standards and certification requirements for recreational vehicles are set out in 40 CFR part 1051, with additional specifications for evaporative emission standards in 40 CFR part 1060. We are adopting the following amendments to parts 1051 and 1060:

- *Section 1051.115(d)*: Aligning the time and cost specification related to air-fuel adjustments with those that

apply for physically adjustable parameters we are adopting in 40 CFR 1068.50(e)(1) in this final rule. This creates a uniform set of specifications for time and cost thresholds for all types of adjustable parameters.

- *Sections 1051.501(c) and 1060.515(c) and (d)*: Creating an exception to the ambient temperature specification for fuel-line testing to allow for removing the test article from an environmental chamber for daily weight measurements. This amendment aligns with our recent change to allow for this same exception in the measurement procedure for fuel tank permeation (86 FR 34308, June 29, 2021).

- *Section 1051.501(c)*: Specifying that fuel-line testing involves daily weight measurements for 14 days. This is consistent with the specifications in 40 CFR 1060.515. This amendment codifies EPA's guidance to address these test parameters that are missing from the referenced SAE J30 test procedure.<sup>591</sup>

- *Section 1051.501(d)*: Updating referenced procedures. The referenced procedure in 40 CFR 1060.810 is the 2006 version of ASTM D471. We inadvertently left the references in 40 CFR 1051.501 to the 1998 version of ASTM D471. Citing the standard without naming the version allows us to avoid a similar error in the future.

- *Section 1051.515*: Revising the soak period specification to allow an alternative of preconditioning fuel tanks at  $43 \pm 5$  °C for 10 weeks. The existing regulation allows for a soak period that is shorter and higher temperature than the specified soak of  $28 \pm 5$  °C for 20 weeks. This approach to an alternative soak period is the same as what is specified in 40 CFR 1060.520(b)(1).

- *Section 1060.520*: Adding “±” where that was inadvertently omitted in describing the temperature range that applies for soaking fuel tanks for 10 weeks.

We are adopting an additional amendment related to snowmobile emission standards. The original exhaust emission standards for snowmobiles in 40 CFR 1051.103 included standards for NO<sub>x</sub> emissions. However, EPA removed those NO<sub>x</sub> emission standards in response to an adverse court decision.<sup>592</sup> We are

therefore removing the reference to NO<sub>x</sub> emissions in the description of emission credits for snowmobiles in 40 CFR 1051.740(b).

We received no comments on the proposed provisions for recreational vehicles and are finalizing the proposed changes without modification.

#### *I. Marine Diesel Engines (40 CFR Parts 1042 and 1043)*

EPA's emission standards and certification requirements for marine diesel engines under the CAA are in 40 CFR part 1042. Emission standards and related fuel requirements that apply internationally are in 40 CFR part 1043. We are finalizing the amendments in 40 CFR parts 1042 and 1043 as proposed, except as specifically noted.

##### 1. Production-Line Testing

Engine manufacturers have been testing production engines as described in 40 CFR part 1042. This generally involves testing up to 1 percent of production engines for engine families with production volumes greater than 100 engines. We adopted these testing provisions in 1999 with the expectation that most families would have production volumes greater than 100 engines per year (64 FR 73300, December 29, 1999). That was the initial rulemaking to set emission standards for marine diesel engines. As a result, there was no existing certification history to draw on for making good estimates of the number of engine families or the production volumes in those engine families. Now that we have almost 20 years of experience in managing certification for these engines, we can observe that manufacturers have certified a few engine families with production volumes substantially greater than 100 engines per year, but many engine families are not subject to production-line testing because production volumes are below 100 engines per year. As a result, manufacturers test several engines in large engine families, but many engine families have no production-line testing at all.

We are revising the production-line testing regimen for marine diesel engines to reflect a more tailored approach. The biggest benefit of production-line testing for this sector is to confirm that engine manufacturers can go beyond the prototype engine build for certification and move to building compliant engines in a

production environment. From this perspective, the first test is of most value, with additional tests adding assurance of proper quality control procedures for ongoing production. Additional testing might also add value to confirm that design changes and updated production practices over time do not introduce problems.

Testing is based on a default engine sampling rate of one test per family. An engine test from an earlier year counts as a sufficient demonstration for an engine family, as long as the manufacturer certifies the engine family using carryover emission data. At the same time, we are removing the testing exemption for small-volume engine manufacturers and low-volume engine families. In summary, this approach:

- Removes the testing exemption for low-volume families and small-volume manufacturers, and remove the 1 percent sampling rate. The amendments revise the engine sampling instruction to require one test for each family. A test from a prior year can meet the test requirement for carryover families. This includes tests performed before these changes to the regulation become effective. This may also involve shared testing for recreational and commercial engine families if they rely on the same emission-data engine.

- Requires a single test engine randomly selected early in the production run. EPA may direct the manufacturer to select a specific configuration and build date. The manufacturer continues to be subject to the requirement to test two more engines for each failing engine, and notify EPA if an engine family fails.

- Requires a full test report within 45 days after testing is complete for the family. There are no additional quarterly or annual reports.

- Allows manufacturers to transition to the new test requirements by spreading out tests over multiple years if several engine families are affected. Small-volume engine manufacturers need to test no more than two engine families in a single model year, and other engine manufacturers need to test no more than four engine families in a single model year.

- Allows EPA to withhold approval of a request for certification for a family for a given year if PLT work from the previous model year is not done.

- Preserves EPA's ability to require an additional test in the same model year or a later model year for cause even after there was a passing result based on any reasonable suspicion that engines may not meet emission standards.

The proposed rule described how the amended regulatory provisions in this

<sup>591</sup> “Evaporative Permeation Requirements for 2008 and Later Model Year New Recreational Vehicles and Highway Motorcycles”, EPA guidance document CD-07-02, March 26, 2007.

<sup>592</sup> “Bluewater Network vs. EPA, No. 03-1003, September Term, 2003” Available here: <https://www.govinfo.gov/content/pkg/USCOURTS-caDC-03-01249/pdf/USCOURTS-caDC-03-01249-0.pdf>. The Court found that the EPA had authority to regulate CO under CAA 213(a)(3) and HC under

CAA 213(a)(4), but did not have authority to regulate NO<sub>x</sub> under CAA 213(a)(4) as it was explicitly referred to in CAA 213(a)(2) and CAA 213(a)(4) only grants authority to regulate emissions “not referred to in paragraph (2).”

rule are different than what we included in an earlier draft document in anticipation of the proposed regulations.

An EPA decision to require additional testing for cause would include a more detailed description to illustrate the types of concerns leading us to identify the need for additional testing. Reporting defects for an engine family would raise such a concern. In addition, amending applications for certification might also raise concerns.<sup>593</sup> Decreasing an engine family's Family Emission Limit without submitting new emission data would be a concern because the manufacturer would appear to be creating credits from what was formerly considered a necessary compliance margin. Changing suppliers or specifications for critical emission-related components would raise concerns about whether the emission controls system is continuing to meet performance expectations. Adding a new or modified engine configuration always involves a judgment about whether the original test data continue to represent the worst-case configuration for the expanded family. In any of these cases, we may direct the manufacturer to perform an additional test with a production engine to confirm that the family meets emission standards. In addition to these specific concerns, we expect manufacturers to have a greater vigilance in making compliant products if they know that they may need to perform additional testing. Conversely, removing the possibility of further testing for the entirety of a production run spanning several years could substantially weaken our oversight presence to ensure compliance.

The net effect of the changes for production-line testing will be a substantial decrease in overall testing. We estimate industry-wide testing will decrease by about 30 engines per year. Spreading test requirements more widely across the range of engine families should allow for a more effective program in spite of the reduced testing rate. We acknowledge that some individual companies will test more engines; however, by limiting default test rates to one per engine family, including future years, this represents a small test burden even for the companies with new or additional testing requirements.

We are adopting two additional clarifications related to production-line testing. First, we are clarifying that test

results from the as-built engine are the final results to represent that engine. Manufacturers may modify the test engine to develop alternative strategies or to better understand the engine's performance; however, testing from those modified engines do not represent the engine family unless the manufacturer changes their production processes for all engines to match those engine modifications. Testing modified engines to meet production-line testing obligations counts as a separate engine rather than replacing the original test results.

Second, we are clarifying that Category 3 auxiliary engines exempted from EPA certification under part 1042 continue to be subject to production-line testing under 40 CFR 1042.305. This question came up because we recently amended 40 CFR 1042.650(d) to allow Category 3 auxiliary engines installed in certain ships to meet Annex VI certification requirements instead of EPA certification requirements under part 1042 (86 FR 34308, June 29, 2021). As with Category 1 and Category 2 engines covered by production-line testing requirements in 40 CFR 1042.301, these test requirements apply for all engines subject to part 1042, even if they are not certified under part 1042.

Third, we are clarifying that manufacturers need to test engines promptly after selecting them for production-line testing. This is intended to allow flexibility where needed, for example, if engines need to be transported to an off-site laboratory for testing. Except for meeting those logistical needs, we would expect manufacturers to prioritize completion of their test requirements to allow for a timely decision for the family. While we did not propose this edit, adding the textual clarification to the final rule is consistent with EPA's expectation and the intent of the original provisions. This edit adds clarity without creating any new or additional test burden.

We received no comments on the proposed amendments related to production-line testing and are finalizing these provisions as proposed, except as noted for the timing of performing tests.

## 2. Applying Reporting Requirements to EGR-Equipped Engines

EPA received comments suggesting that we apply the SCR-related monitoring and reporting requirements in 40 CFR 1042.660(b) to engines that instead use exhaust gas recirculation (EGR) to meet Tier 4 standards. We understand SCR and EGR to be fundamentally different in ways that

lead us not to make this suggested change.

### i. Maintenance

There are two principal modes of EGR failure: (1) Failure of the valve itself (physically stuck or not able to move or adjust within normal range) and (2) EGR cooler fouling. EGR cooler maintenance is typically listed in the maintenance instructions provided by engine manufacturers to owners. If done according to the prescribed schedule, this should prevent fouling of the EGR cooler. Similarly, EGR valves typically come with prescribed intervals for inspection and replacement. For both components, the intervals are long and occur at the time that other maintenance is routinely performed. Under 40 CFR 1042.125(a)(2), the minimum interval for EGR-related filters and coolers is 1500 hours, and the minimum interval for other EGR-related components is either 3000 hours or 4500 hours depending on the engine's max power.

In contrast, SCR systems depend on the active, ongoing involvement of the operator to maintain an adequate supply of Diesel Exhaust Fluid (DEF) as a reductant to keep the catalyst functioning properly. EPA does not prescribe the size of DEF storage tanks for vessels, but the engine manufacturers provide installation instructions with recommendations for tank sizing to ensure that enough DEF is available onboard for the duration of a workday or voyages between ports. At the frequencies that this fluid needs replenishing, it is not expected that other routine maintenance must also be performed, aside from refueling.

DEF consumption from marine diesel engines is estimated to be 3–8 percent of diesel fuel consumption. Recommended DEF tank sizes are generally about 10 percent of the onboard fuel storage, with the expectation that operators refill DEF tanks during a refueling event.

Another point of contrast is that SCR systems have many failure modes in addition to the failure to maintain an adequate supply of reductant. For example, dosing may stop due to faulty sensors, malfunctions of components in the reductant delivery system, or freezing of the reductant.

Over the years of implementing regulations for which SCR is the adopted technology, EPA has produced several guidance documents to assist manufacturers in developing approvable SCR engine designs.<sup>594 595 596</sup> Many of

<sup>593</sup> In this context, making the described changes in an application for certification applies equally for running changes within a model year and for changes that are introduced at the start of a new model year.

<sup>594</sup> "Revised Guidance for Certification of Heavy-Duty Diesel Engines Using Selective Catalyst



the features implemented to assure that SCR systems are properly maintained by vehicle and equipment operators are not present with systems on marine vessels. Thus, we rely on the reporting provision of 40 CFR 1042.660(b) to enhance our assurance that maintenance will occur as prescribed.

#### ii. Tampering

Engine manufacturers and others have asked questions about generation of condensate from an EGR-equipped engine. This condensate is an acidic liquid waste that must be discharged in accordance with water quality standards (and IMO, U.S. Coast Guard, and local port rules). The Tier 4 EGR-equipped engines that EPA has certified are believed to generate a very small amount of EGR condensate. Larger quantities of condensate may be generated from an aftercooler, but that is non-acidic, non-oily water that generally does not need to be held onboard or treated. In the absence of compelling information to the contrary, we believe the burden of storing, treating, and discharging the EGR condensate is not great enough to motivate an operator to tamper with the engine.

Most EGR-equipped engines have internal valves and components that are not readily accessible to operators. In these cases, the controls to activate or deactivate EGR are engaged automatically by the engine's electronic control module and are not vulnerable to operator tampering. Where an engine design has external EGR, even though emission-related components may be somewhat accessible to operators, the controls are still engaged automatically by the engine's electronic control module and continued compliance is ensured if prescribed maintenance is performed on schedule and there is no tampering.

#### iii. Nature of the Risk

There are five manufacturers actively producing hundreds of certified Category 1 marine diesel engines each year using EGR to achieve Tier 3 emission standards. EPA is aware of no suggestion that these EGR controls are susceptible to tampering or malmaintenance.

There is one manufacturer who has certified two Category 3 marine diesel engine families using EGR to achieve

the Tier 3 emission standards for these large engines. If there is any risk with these, it's that the ocean-going vessel may not visit an ECA often enough to exercise the EGR valve and prevent it from getting corroded or stuck. These engines are already subject to other onboard diagnostics and reporting requirements, so we expect no need to expand 40 CFR 1042.660(b) for these engines.

There is one manufacturer producing Category 2 marine diesel engines using EGR to achieve the Tier 4 emission standards. We again do not see the need to include them in the reporting scheme in 40 CFR 1042.660(b).

#### 3. Miscellaneous Amendments for Marine Diesel Engines

We are adopting the following additional amendments for our marine diesel engine program, which we are finalizing as proposed unless specifically noted otherwise:

- *Sections 1042.110 and 1042.205:* Revising text to refer to “warning lamp” instead of “malfunction indicator light” to prevent confusion with conventional onboard diagnostic controls. This aligns with changes adopted for land-based nonroad diesel engines in 40 CFR part 1039. We are also clarifying that the manufacturer's description of the diagnostic system in the application for certification needs to identify which communication protocol the engine uses.
- *Section 1042.110:* Revising text to refer more broadly to detecting a proper supply of Diesel Exhaust Fluid to recognize, for example, that a closed valve may interrupt the supply (not just an empty tank).
- *Section 1042.115:* Revising provisions related to adjustable parameters, as described in Section XI.H.1.
- *Section 1042.115:* Adding provisions to address concerns related to vanadium sublimation, as described in Section XI.B.
- *Section 1042.615:* Clarifying that engines used to repower a steamship may be considered to qualify for the replacement engine exemption. This exemption applies relative to EPA standards in 40 CFR part 1042. We are also amending 40 CFR 1043.95 relative to the application of MARPOL Annex VI requirements for repowering Great Lakes steamships.
- *Section 1042.660(b):* Revising the instruction for reporting related to vessel operation without reductant for SCR-equipped engines to describe the essential items to be reported, which includes the cause, the remedy, and an estimate of the extent of operation

without reductant. We are also revising the contact information for reporting, and to clarify that the reporting requirement applies equally for engines that meet standards under MARPOL Annex VI instead of or in addition to meeting EPA standards under part 1042. We are also aware that vessel owners may choose to voluntarily add SCR systems to engines certified without aftertreatment; we are clarifying that the reporting requirement of 40 CFR 1042.660(b) does not apply for these uncertified systems. These changes are intended to clarify the reporting instructions for manufacturers under this provision rather than creating a new reporting obligation. In response to a question raised after the proposal, we note that the regulatory text requires reporting under 40 CFR 1042.660(b) for *any* vessel operation without the appropriate reductant, regardless of what caused the noncompliance.

- *Section 1042.901:* Clarifying that the displacement value differentiating Category 1 and Category 2 engines subject to Tier 1 and Tier 2 standards was 5.0 liters per cylinder, rather than the value of 7.0 liters per cylinder that applies for engines subject to Tier 3 and Tier 4 standards.

- *Part 1042, appendix I:* Correcting the decimal places to properly identify the historical Tier 1 and Tier 2 p.m. standards for 19–37 kW engines.

- *Section 1043.20:* Revising the definition of “public vessel” to clarify how national security exemptions relate to applicability of requirements under MARPOL Annex VI. Specifically, vessels with an engine-based national security exemption are exempt from NO<sub>x</sub> standards under MARPOL Annex VI, and vessels with a fuel-based national security exemption are exempt from the fuel standards under MARPOL Annex VI. Conversely, an engine-based national security exemption does not automatically exempt a vessel from the fuel standards under MARPOL Annex VI, and a fuel-based national security exemption does not automatically exempt a vessel from the NO<sub>x</sub> standards under MARPOL Annex VI. These distinctions are most likely to come into play for merchant marine vessels that are intermittently deployed for national (noncommercial) service.

- *Section 1043.55:* Revising text to clarify that U.S. Coast Guard is the approving authority for technologies that are equivalent to meeting sulfur standards under Regulation 4 of MARPOL Annex VI.

- *Section 1043.95:* Expanding the Great Lakes steamship provisions to allow for engine repowers to qualify for an exemption from the Annex VI Tier III

Reduction (SCR) Technologies”, EPA guidance document C1SD-09-04, December 30, 2009.

<sup>595</sup> “Nonroad SCR Certification”, EPA Webinar Presentation, July 26, 2011.

<sup>596</sup> “Certification of Nonroad Diesel Engines Equipped with SCR Emission Controls”, EPA guidance document CD-14-10, May 12, 2014.

NO<sub>x</sub> standard. This amendment allows EPA to approve a ship owner's request to install engines meeting the IMO Tier II NO<sub>x</sub> standard. Consistent with EPA's determination for EPA Tier 4 engines replacing engines certified to earlier tiers of standards under 40 CFR 1042.615(a)(1), we understand that engines certified to the Annex VI Tier III NO<sub>x</sub> standard may not have the appropriate physical or performance characteristics to replace a steamship's powerplant. This new provision is therefore intended to create an incentive for shipowners to upgrade the vessel by replacing steam boilers with IMO Tier II engines, with very substantial expected reductions in NO<sub>x</sub>, PM, and CO<sub>2</sub> emissions compared to emission rates from continued operation as steamships. We are also simplifying the fuel-use exemption for Great Lakes steamships to allow for continued use of high-sulfur fuel for already authorized steamships, while recognizing that the fuel-use exemption is no longer available for additional steamships.

#### J. Locomotives (40 CFR Part 1033)

EPA's emission standards and certification requirements for locomotives and locomotive engines are in 40 CFR part 1033. This final rule includes several amendments that affect locomotives, as discussed in Sections XI.A and XI.L.

In addition, we are amending 40 CFR 1033.815 to clarify how penalty provisions apply relative to maintenance and remanufacturing requirements. We have become aware that the discussion of violations and penalties in 40 CFR 1033.815(f) addresses failure to perform required maintenance but omits reference to the recordkeeping requirements described in that same regulatory section. We originally adopted the maintenance and recordkeeping requirements with a statement describing that failing to meet these requirements would be considered a violation of the tampering prohibition in 40 CFR 1068.101(b)(1). The requirement for owners to keep records for the specified maintenance are similarly tied to the tampering prohibition, but failing to keep required records cannot be characterized as a tampering violation per se. As a result, we are amending 40 CFR 1033.815(f) to clarify that a failure to keep records violates 40 CFR 1068.101(a)(2).

We are also amending 40 CFR 1033.815(f) to specifically name the tampering prohibition as the relevant provision related to maintenance requirements for locomotives, rather than making a more general reference to prohibitions in 40 CFR 1068.101.

We are amending 40 CFR 1033.525 to remove the smokemeter requirements and replace them with a reference to 40 CFR 1065.1125, which will serve as the central location for all instrument and setup requirements for measuring smoke. We are also adding data analysis requirements for locomotives to 40 CFR 1033.525 that were never migrated over from 40 CFR 92.131; manufacturers still use these procedures to analyze and submit smoke data for certifying locomotives. It is our understanding is that all current smoke testing includes computer-based analysis of measured results; we are therefore removing the references to manual or graphical analysis of smoke test data.

Finally, we are amending 40 CFR 1033.1 to clarify that 40 CFR part 1033 applies to engines that were certified under part 92 before 2008. We are also removing 40 CFR 1033.102 and revising 40 CFR 1033.101 and appendix A of part 1033 to more carefully describe how locomotives were subject to different standards in the transition to the standards currently specified in 40 CFR 1033.101.

We received no comments on these proposed amendments and are finalizing the proposed amendments without modification.

#### K. Stationary Compression-Ignition Engines (40 CFR Part 60, Subpart IIII)

EPA's emission standards and certification requirements for stationary compression-ignition engines are in 40 CFR part 60, subpart IIII. Section 60.4202 establishes emission standards for stationary emergency compression-ignition engines. We are correcting a reference in 40 CFR 60.4202 to the Tier 3 standards for marine engines contained in 40 CFR part 1042. EPA emission standards for certain engine power ratings go directly from Tier 2 to Tier 4. Such engines are never subject to Tier 3 standards, so the reference in 40 CFR 60.4202 is incorrect. Section 60.4202 currently describes the engines as those that otherwise "would be subject to the Tier 4 standards". We are amending the regulation to more broadly refer to the "previous tier of standards" instead of naming Tier 3. In most cases, this will continue to apply the Tier 3 standards for these engines, but the Tier 2 standards will apply if the regulation specifies no Tier 3 standard.

We received no comments on the proposed amendment and are finalizing the proposed amendment without modification.

#### L. Nonroad Compression-Ignition Engines (40 CFR Part 1039)

EPA's emission standards and certification requirements for nonroad compression-ignition engines are in 40 CFR part 1039. We are republishing the tables with Tier 1 and Tier 2 standards in appendix I of 40 CFR part 1039 to correctly characterize these historical standards. The tables codified in the CFR included errors that were introduced in the process of publishing those standards (86 FR 34308, June 29, 2021).<sup>597</sup>

## XII. Statutory and Executive Order Reviews

Additional information about these statutes and Executive Orders can be found at <http://www.epa.gov/laws-regulations/laws-and-executive-orders>.

#### A. Executive Order 12866: Regulatory Planning and Review and Executive Order 13563: Improving Regulation and Regulatory Review

This action is an economically significant regulatory action that was submitted to the Office of Management and Budget (OMB) for review. Any changes made in response to OMB recommendations have been documented in the docket. EPA prepared an analysis of the potential costs and benefits associated with this action. This analysis, the "Regulatory Impact Analysis—Control of Air Pollution from New Motor Vehicles: Heavy-Duty Engine and Vehicle Standards," is available in the docket. The analyses contained in this document are also summarized in Sections V, VI, VII, VIII, IX, and X of this preamble.

#### B. Paperwork Reduction Act (PRA)

The information collection activities in this rule have been submitted for approval to the Office of Management and Budget (OMB) under the PRA. The Information Collection Request (ICR) document that EPA prepared has been assigned EPA ICR Number 2621.02. You can find a copy of the ICR in the docket for this rule, and it is briefly summarized here. The information collection requirements are not enforceable until OMB approves them.

The rule builds on existing certification and compliance requirements required under title II of the Clean Air Act (42 U.S.C. 7521 *et seq.*). Existing requirements are covered under two ICRs: (1) EPA ICR Number 1684.20, OMB Control Number 2060–

<sup>597</sup> Stout, Alan. Memorandum to docket EPA–HQ–OAR–2019–0055. "Correction to Tables in 40 CFR part 1039, Appendix I". June 7, 2022.

0287, Emissions Certification and Compliance Requirements for Nonroad Compression-ignition Engines and On-highway Heavy Duty Engines; and (2) EPA ICR Number 1695.14, OMB Control Number 2060-0338, Certification and Compliance Requirements for Nonroad Spark-ignition Engines. Therefore, this ICR only covers the incremental burden associated with the updated regulatory requirements as described in this final rule.

- *Respondents/affected entities:* The entities potentially affected by this action are manufacturers of engines and vehicles in the heavy-duty on-highway industries, including alternative fuel converters, and secondary vehicle manufacturers. Manufacturers of light-duty vehicles, light-duty trucks, marine diesel engines, locomotives, and various other types of nonroad engines, vehicles, and equipment may be affected to a lesser degree.

- *Respondent's obligation to respond:* Regulated entities must respond to this collection if they wish to sell their products in the United States, as prescribed by CAA section 203(a). Participation in some programs is voluntary; but once a manufacturer has elected to participate, it must submit the required information.

- *Estimated number of respondents:* Approximately 279 (total).

- *Frequency of response:* Annually or on occasion, depending on the type of response.

- *Total estimated burden:* 16,951 hours per year. Burden is defined at 5 CFR 1320.03(b).

- *Total estimated cost:* \$3,313,619 (per year), includes an estimated \$1,685,848 annualized capital or maintenance and operational costs.

An agency may not conduct or sponsor, and a person is not required to respond to, a collection of information unless it displays a currently valid OMB control number. The OMB control numbers for EPA's regulations in title 40 of the Code of Federal Regulations are listed in 40 CFR part 9. When OMB approves this ICR, the Agency will announce that approval in the **Federal Register** and amend 40 CFR part 9 as needed to display the OMB control number for the approved information collection activities contained in this final rule.

### C. Regulatory Flexibility Act (RFA)

I certify that this action will not have a significant economic impact on a substantial number of small entities under the RFA. The small entities subject to the requirements of this final action are heavy-duty alternative fuel engine converters and heavy-duty

secondary vehicle manufacturers. While this final rule also includes regulatory amendments for sectors other than highway heavy-duty engines and vehicles, these amendments for other sectors correct, clarify, and streamline the regulatory provisions and they will impose no additional burden on small entities in these other sectors.

We identified 251 small entities in the heavy-duty sector that are expected to be subject to the final rule: Two heavy-duty alternative fuel engine converters and 249 heavy-duty secondary vehicle manufacturers. The Agency has determined that 203 of the 251 small entities subject to the rule are expected to experience an impact of less than 1 percent of annual revenue; 48 small entities are expected to experience an impact of 1 to less than 3 percent of annual revenue; and no small entity is expected to experience an impact of 3 percent or greater of annual revenue. Specifically, the two alternative fuel engine converters and 201 secondary vehicle manufacturers are expected to experience an impact of less than 1 percent of annual revenue, and 48 secondary vehicle manufacturers are expected to experience an impact of 1 to less than 3 percent of annual revenue. Details of this analysis are presented in Chapter 11 of the RIA.

### D. Unfunded Mandates Reform Act (UMRA)

This action contains no unfunded Federal mandate for State, local, or Tribal governments as described in UMRA, 2 U.S.C. 1531-1538, and does not significantly or uniquely affect small governments. This action imposes no enforceable duty on any State, local or Tribal government. This action contains Federal mandates under UMRA that may result in annual expenditures of \$100 million or more for the private sector. Accordingly, the costs and benefits associated with this action are discussed in Section IX of this preamble and in the RIA, which is in the docket for this rule.

This action is not subject to the requirements of UMRA section 203 because it contains no regulatory requirements that might significantly or uniquely affect small governments.

### E. Executive Order 13132: Federalism

This action does not have Federalism implications. It will not have substantial direct effects on states, on the relationship between the national government and states, or on the distribution of power and responsibilities among the various levels of government.

### F. Executive Order 13175: Consultation and Coordination With Indian Tribal Governments

This action does not have Tribal implications as specified in Executive Order 13175. This action does not have substantial direct effects on one or more Indian tribes, on the relationship between the Federal Government and Indian tribes, or on the distribution of power and responsibilities between the Federal Government and Indian tribes. Thus, Executive Order 13175 does not apply to this action.

### G. Executive Order 13045: Protection of Children From Environmental Health and Safety Risks

This action is subject to Executive Order 13045 because it is an economically significant regulatory action as defined by Executive Order 12866, and EPA believes that the environmental health risks or safety risks addressed by this action may have a disproportionate effect on children. The 2021 Policy on Children's Health also applies to this action. Accordingly, we have evaluated the environmental health or safety effects of air pollutants affected by this program on children. The results of this evaluation are described in Section II regarding the Need for Additional Emissions Control and associated references in Section II. The protection offered by these standards may be especially important for children because childhood represents a life stage associated with increased susceptibility to air pollutant-related health effects.

Children make up a substantial fraction of the U.S. population, and often have unique factors that contribute to their increased risk of experiencing a health effect from exposures to ambient air pollutants because of their continuous growth and development. Children are more susceptible than adults to many air pollutants because they have (1) a developing respiratory system, (2) increased ventilation rates relative to body mass compared with adults, (3) an increased proportion of oral breathing, particularly in boys, relative to adults, and (4) behaviors that increase chances for exposure. Even before birth, the developing fetus may be exposed to air pollutants through the mother that affect development and permanently harm the individual when the mother is exposed.

Certain motor vehicle emissions present greater risks to children as well. Early lifestages (e.g., children) are thought to be more susceptible to tumor development than adults when exposed to carcinogenic chemicals that act

through a mutagenic mode of action.<sup>598</sup> Exposure at a young age to these carcinogens could lead to a higher risk of developing cancer later in life. Section II.B.7 describes a systematic review and meta-analysis conducted by the U.S. Centers for Disease Control and Prevention that reported a positive association between proximity to traffic and the risk of leukemia in children.

The adverse effects of individual air pollutants may be more severe for children, particularly the youngest age groups, than adults. As described in Section II.B, the Integrated Science Assessments for a number of pollutants affected by this rule, including those for NO<sub>2</sub>, PM, ozone and CO, describe children as a group with greater susceptibility. Section II.B.7 discusses a number of childhood health outcomes associated with proximity to roadways, including evidence for exacerbation of asthma symptoms and suggestive evidence for new onset asthma.

There is substantial evidence that people who live or attend school near major roadways are more likely to be people of color, Hispanic ethnicity, and/or low SES. Within these highly exposed groups, children's exposure and susceptibility to health effects is greater than adults due to school-related and seasonal activities, behavior, and physiological factors.

Section VI.B of this preamble presents the estimated emission reductions from

this final rule, including substantial reductions in NO<sub>x</sub> and other criteria and toxic pollutants. Section VII of this preamble presents the air quality impacts of this final rule. The air quality modeling predicts decreases in ambient concentrations of air pollutants in 2045 due to these standards, including significant improvements in ozone concentrations. Ambient PM<sub>2.5</sub>, NO<sub>2</sub> and CO concentrations are also predicted to improve in 2045 because of this program. We also expect this rule's emission reductions to reduce air pollution in close proximity to major roadways.

Children are not expected to experience greater ambient concentrations of air pollutants than the general population. However, because of their greater susceptibility to air pollution and their increased time spent outdoors, it is likely that these standards will have particular benefits for children's health.

*H. Executive Order 13211: Actions Concerning Regulations That Significantly Affect Energy Supply, Distribution, or Use*

This action is not a "significant energy action" because it is not likely to have a significant adverse effect on the supply, distribution, or use of energy. In fact, this final rule will have an incremental positive impact on energy supply and use. Section III.E and

Section V describe our projected fuel savings due to new refueling emissions standards for certain Spark-ignition heavy-duty vehicles. These refueling emission standards require manufacturers to implement emission control systems to trap vented fuel instead of releasing it into the ambient air during a refueling event. Considering the estimated incremental fuel savings from the new refueling emission standards, we have concluded that this rule is not likely to have any adverse energy effects.

*I. National Technology Transfer and Advancement Act (NTTAA) and 1 CFR Part 51*

This action involves technical standards. Except for the standards discussed in this section, the standards included in the regulatory text as incorporated by reference were all previously approved for IBR and no change is included in this action.

In accordance with the requirements of 1 CFR 51.5, we are incorporating by reference the use of test methods and standards from ASTM International (ASTM). The referenced standards and test methods may be obtained through the ASTM website ([www.astm.org](http://www.astm.org)) or by calling (610) 832-9585. We are incorporating by reference the following ASTM standards:

Standard or test method	Regulation	Summary
ASTM D975-22, Standard Specification for Diesel Fuel." .....	40 CFR 1036.415(c) and 1036.810(a).	Fuel specification needed for manufacturer-run field-testing program. This is a newly referenced standard.
ASTM D3588-98 (Reapproved 2017)e1, Standard Practice for Calculating Heat Value, Compressibility Factor, and Relative Density of Gaseous Fuels.	40 CFR 1036.550(b) and 1036.810(a).	Test method describes how to measure mass-specific net energy content and related parameters of gaseous fuels.
ASTM D4809-18, Standard Test Method for Heat of Combustion of Liquid Hydrocarbon Fuels by Bomb Calorimeter (Precision Method).	40 CFR 1036.550(b) and 1036.810(a).	Test method describes how to determine the heat of combustion of liquid hydrocarbon fuels. This reference test method replaces an earlier version.
ASTM D4814-21c, Standard Specification for Automotive Spark-Ignition Engine Fuel.	40 CFR 1036.415(c) and 1036.810(a).	Fuel specification needed for manufacturer-run field-testing program. This is a newly referenced standard.
ASTM D7467-20a, Standard Specification for Diesel Fuel Oil, Biodiesel Blend (B6 to B20).	40 CFR 1036.415(c) and 1036.810(a).	Fuel specification needed for manufacturer-run field-testing program. This is a newly referenced standard.

In accordance with the requirements of 1 CFR 51.5, we are incorporating by reference the use of test methods and standards from SAE International. The

referenced standards and test methods may be obtained through the SAE International website ([www.sae.org](http://www.sae.org)) or by calling (800) 854-7179. We are

incorporating by reference the following SAE International standards and test methods:

Standard or test method	Regulation	Summary
SAE J1634, July 2017, Battery Electric Vehicle Energy Consumption and Range Test Procedure.	40 CFR 600.011(c), 600.116-12(a), 600.210-12(d), and 600.311-12(j) and (k). 40 CFR 1066.501(a) and 1066.1010(b).	The procedure describes how to measure energy consumption and range from electric vehicles. This is an updated version of the document currently specified in the regulation.
SAE J1711, June 2010, Recommended Practice for Measuring the Exhaust Emissions and Fuel Economy of Hybrid-Electric Vehicles, Including Plug-In Hybrid Vehicles.	40 CFR 1066.501(a), 1066.1001, and 1066.1010(b).	The recommended practice describes how to measure fuel economy and emissions from light-duty vehicles, including hybrid-electric vehicles. This final rule cites the reference document in an additional place in the regulation.

<sup>598</sup> U.S. Environmental Protection Agency (2005). Supplemental guidance for assessing susceptibility

from early-life exposure to carcinogens. Washington, DC: Risk Assessment Forum. EPA/630/

R-03/003F. [https://www3.epa.gov/airtoxics/childrens\\_supplement\\_final.pdf](https://www3.epa.gov/airtoxics/childrens_supplement_final.pdf).

Standard or test method	Regulation	Summary
SAE J1979-2, April 22, 2021, E/E Diagnostic Test Modes: OBDOnUDS.	40 CFR 1036.150(v) and 1036.810(c).	The standard includes information describing interface protocols for onboard diagnostic systems. This is a newly referenced standard.
SAE J2263, May 2020, Road Load Measurement Using On-board Anemometry and Coastdown Techniques.	40 CFR 1037.528 introductory text, (a), (b), (d), and (f), 1037.665(a), and 1037.810(e). 40 CFR 1066.301(b), 1066.305, 1066.310(b), 1066.1010(b).	The procedure describes how to perform coastdown measurements with light-duty and heavy-duty vehicles. This is an updated version of the document currently specified in the regulation. We are keeping the reference to the older version of the same procedure to allow for continued testing with that procedure through model year 2025.
SAE J2711, May 2020, Recommended Practice for Measuring Fuel Economy and Emissions of Hybrid-Electric and Conventional Heavy-Duty Vehicles.	40 CFR 1066.501(a), 1066.1001, and 1066.1010(b).	The recommended practice describes how to measure fuel economy and emissions from heavy-duty vehicles, including hybrid-electric vehicles. This is an updated version of the document currently specified in the regulation.
SAE J2841, March 2009, Utility Factor Definitions for Plug-In Hybrid Electric Vehicles Using 2001 U.S. DOT National Household Travel Survey Data.	40 CFR 1037.550(a) and 1037.810(e).	The standard practice establishes terminology and procedures for calculating emission rates and fuel consumption for plug-in hybrid electric vehicles.

In accordance with the requirements of 1 CFR 51.5, we are incorporating by reference the use of test methods and standards from the California Air Resources Board (CARB), published by

the State of California in the California Code of Regulations (CCR). The referenced standards and test methods may be obtained through the CARB website ([www.arb.ca.gov](http://www.arb.ca.gov)) or by calling

(916) 322-2884. We are incorporating by reference the following CARB documents:

Standard or test method	Regulation	Summary
2019 13 CCR 1968.2: Title 13. Motor Vehicles, Division 3. Air Resources Board, Chapter 1. Motor Vehicle Pollution Control Devices, Article 2. Approval of Motor Vehicle Pollution Control Devices (New Vehicles), § 1968.2. Malfunction and Diagnostic System Requirements—2004 and Subsequent Model-Year Passenger Cars, Light-Duty Trucks, and Medium-Duty Vehicles and Engines.	40 CFR 1036.110(b), 1036.111(a), and 1036.810(d).	The CARB standards establish requirements for onboard diagnostic systems for heavy-duty vehicles. These are newly referenced standards.
2019 13 CCR 1968.5: Title 13. Motor Vehicles, Division 3. Air Resources Board, Chapter 1. Motor Vehicle Pollution Control Devices, Article 2. Approval of Motor Vehicle Pollution Control Devices (New Vehicles), § 1968.5. Enforcement of Malfunction and Diagnostic System Requirements for 2004 and Subsequent Model-Year Passenger Cars, Light-Duty Trucks, and Medium-Duty Vehicles and Engines.	40 CFR 1036.110(b) and 1036.810(d).	The CARB standards establish requirements for onboard diagnostic systems for heavy-duty vehicles. These are newly referenced standards.
2019 13 CCR 1971.1: Title 13. Motor Vehicles, Division 3. Air Resources Board, Chapter 1. Motor Vehicle Pollution Control Devices, Article 2. Approval of Motor Vehicle Pollution Control Devices (New Vehicles), § 1971.1. On-Board Diagnostic System Requirements—2010 and Subsequent Model-Year Heavy-Duty Engines.	40 CFR 1036.110(b), 1036.111(a), 1036.150(v), and 1036.810(d).	The CARB standards establish requirements for onboard diagnostic systems for heavy-duty vehicles. This is a newly referenced standard.
13 CA ADC 1971.5: 2019 CA REG TEXT 504962 (NS) California's 2019 heavy-duty OBD requirements, 13 CA ADC 1971.5. Enforcement of Malfunction and Diagnostic System Requirements for 2010 and Subsequent Model-Year Heavy-Duty Engines.	40 CFR 1036.110(b) and 1036.810(d).	The California standards establish requirements for onboard diagnostic systems for heavy-duty vehicles. These are newly referenced standards.

The following standards are already approved for the reg text in which they appear: ASTM D1267; ASTM D1838; ASTM D2163; ASTM D2158; ASTM D2598; ASTM D2713; ASTM D5291; ASTM D6667; GEM Phase 2; ISO/IEC 18004:2006(E); ISO 28580; NIST Special Publication 811; NIST Technical Note 1297; SAE J30; SAE J1263; SAE J1527; SAE J2263 DEC2008; SAE J2996.

*J. Executive Order 12898: Federal Actions To Address Environmental Justice in Minority Populations and Low-Income Populations*

Executive Order 12898 (59 FR 7629, February 16, 1994) directs Federal agencies, to the greatest extent practicable and permitted by law, to make environmental justice part of their mission by identifying and addressing, as appropriate, disproportionately high

and adverse human health or environmental effects of their programs, policies, and activities on minority populations (people of color and/or indigenous peoples) and low-income populations.

The EPA believes that the human health or environmental conditions that exist prior to this action result in or have the potential to result in disproportionate and adverse human health or environmental effects on people of color, low-income populations and/or indigenous peoples. EPA provides a summary of the evidence for potentially disproportionate and adverse effects among people of color and low-income populations in Section VII.H of this preamble.

EPA believes that this action is likely to reduce existing disproportionate and adverse effects on people of color, low-

income populations and/or indigenous peoples. The information supporting this Executive Order review is contained in Section VII.H of this preamble and Chapter 4.3 and Chapter 6.4.9 of the RIA, and all supporting documents have been placed in the public docket for this action.

Section VII.H of this preamble summarizes evidence that communities with environmental justice concerns are disproportionately impacted by mobile source emissions and will therefore benefit from the anticipated emission reductions. Section VII.H.1 also presents the results of new work showing that, relative to the rest of the population, people living near truck routes are more likely to be people of color and have lower incomes than the general population. EPA's review of populations living near truck routes and the study of

NO<sub>2</sub> reductions during the COVID lockdown together provide evidence that motor vehicle emission reductions may reduce disparities in exposure to traffic-related air pollution.

With respect to emission reductions and associated improvements in air quality, EPA has determined that this rule will benefit all U.S. populations, including people of color, low-income populations, and indigenous peoples. Section VI of this preamble presents the estimated emission reductions, including substantial reductions in NO<sub>x</sub> and other criteria and toxic pollutants. Section VII of this preamble presents the projected air quality impacts. Air quality modeling predicts that this final rule will decrease ambient concentrations of air pollutants in 2045, including significant improvements in ozone concentrations. Ambient PM<sub>2.5</sub>, NO<sub>2</sub> and CO concentrations are also predicted to decrease in 2045 as a result of this final rule. We also expect this rule's emission reductions to reduce air pollution in close proximity to major roadways.

In terms of benefits to human health, reduced ambient concentrations of ozone and PM<sub>2.5</sub> will reduce many adverse environmental and human health impacts in 2045, including reductions in premature deaths and many nonfatal illnesses. These health benefits, described in Section VIII of this preamble, apply for all U.S. populations, including people of color, low-income populations, and indigenous peoples.

EPA conducted a demographic analysis of air quality modeling data in 2045 to examine trends in human exposure to future air quality in scenarios both with and without this final rule. That analysis, summarized in Section VII.H.2 of this preamble and presented in more detail in RIA Chapter 6.3.9, supports the conclusion that in the 2045 baseline, nearly double the number of people of color live within areas with the worst ozone and PM<sub>2.5</sub> air quality compared to non-Hispanic whites. We also found that the largest predicted improvements in both ozone and PM<sub>2.5</sub> are estimated to occur in areas with the worst baseline air quality. This final rule will improve air quality for people of color; however, disparities in PM<sub>2.5</sub> and ozone exposure are projected to remain.

EPA additionally identified environmental justice concerns and took the following actions to enable meaningful involvement in this rulemaking, including: (1) Contacting individuals in environmental justice groups to provide information on pre-registration for the public hearings for

the proposed rule (March 17, 2022); (2) contacting individuals in environmental justice groups again when the proposed rule was published in the **Federal Register** (March 28, 2022); (3) providing information on our website in both Spanish and English, as well as providing Spanish translation during the public hearings for the rule; (4) providing additional time to participate in the public hearings for the proposed rule, including extending the hearings by one day and providing for evening hours; (5) providing an "Overview of EPA's Heavy Duty Vehicle Proposal for EJ Stakeholders" on April 18, 2022; (6) posting materials on our website for the proposed rule, including a copy of materials used for the overview on April 18, 2022 and a fact sheet specific to transportation and environmental justice with information relevant to the proposed rule and related EPA actions.

#### *K. Congressional Review Act*

This action is subject to the Congressional Review Act, and EPA will submit a rule report to each House of the Congress and to the Comptroller General of the United States. This action is a "major rule" as defined by 5 U.S.C. 804(2).

#### *L. Judicial Review*

Under CAA section 307(b)(1), judicial review of this final rule is available only by filing a petition for review in the U.S. Court of Appeals for the District of Columbia Circuit by March 27, 2023. Under CAA section 307(d)(7)(B), only an objection to this final rule that was raised with reasonable specificity during the period for public comment can be raised during judicial review. CAA section 307(d)(7)(B) also provides a mechanism for EPA to convene a proceeding for reconsideration, "[i]f the person raising an objection can demonstrate to EPA that it was impracticable to raise such objection within [the period for public comment] or if the grounds for such objection arose after the period for public comment (but within the time specified for judicial review) and if such objection is of central relevance to the outcome of the rule." Any person seeking to make such a demonstration should submit a Petition for Reconsideration to the Office of the Administrator, Environmental Protection Agency, Room 3000, William Jefferson Clinton Building, 1200 Pennsylvania Ave. NW, Washington, DC 20460, with an electronic copy to the person listed in **FOR FURTHER INFORMATION CONTACT**, and the Associate General Counsel for the Air and Radiation Law Office, Office of General Counsel (Mail Code 2344A),

Environmental Protection Agency, 1200 Pennsylvania Ave. NW, Washington, DC 20004. Note that under CAA section 307(b)(2), the requirements established by this final rule may not be challenged separately in any civil or criminal proceedings brought by EPA to enforce these requirements.

#### **XIII. Statutory Provisions and Legal Authority**

Statutory authority for this rulemaking is in the Clean Air Act (42 U.S.C. 7401–7671q), including CAA sections 202, 203, 206, 207, 208, 213, 216, and 301 (42 U.S.C. 7521, 7522, 7525, 7541, 7542, 7547, 7550, and 7601); the Energy Policy and Conservation Act (49 U.S.C. 32901–32919q); and the Act to Prevent Pollution from Ships (33 U.S.C. 1901–1912).

#### **List of Subjects**

##### *40 CFR Part 2*

Administrative practice and procedure, Confidential business information, Courts, Environmental protection, Freedom of information, Government employees.

##### *40 CFR Part 59*

Air pollution control, Confidential business information, Labeling, Ozone, Reporting and recordkeeping requirements, Volatile organic compounds.

##### *40 CFR Part 60*

Administrative practice and procedure, Air pollution control, Aluminum, Beverages, Carbon monoxide, Chemicals, Coal, Electric power plants, Fluoride, Gasoline, Glass and glass products, Grains, Greenhouse gases, Household appliances, Industrial facilities, Insulation, Intergovernmental relations, Iron, Labeling, Lead, Lime, Metals, Motor vehicles, Natural gas, Nitrogen dioxide, Petroleum, Phosphate, Plastics materials and synthetics, Polymers, Reporting and recordkeeping requirements, Rubber and rubber products, Sewage disposal, Steel, Sulfur oxides, Vinyl, Volatile organic compounds, Waste treatment and disposal, Zinc.

##### *40 CFR Part 80*

Environmental protection, Administrative practice and procedure, Air pollution control, Diesel fuel, Fuel additives, Gasoline, Imports, Oil imports, Petroleum, Renewable fuel.

##### *40 CFR Part 85*

Confidential business information, Greenhouse gases, Imports, Labeling, Motor vehicle pollution, Reporting and

recordkeeping requirements, Research, Warranties.

*40 CFR Part 86*

Environmental protection, Administrative practice and procedure, Confidential business information, Incorporation by reference, Labeling, Motor vehicle pollution, Reporting and recordkeeping requirements.

*40 CFR Part 600*

Environmental protection, Administrative practice and procedure, Electric power, Fuel economy, Incorporation by reference, Labeling, Reporting and recordkeeping requirements.

*40 CFR Part 1027*

Environmental protection, Administrative practice and procedure, Air pollution control, Confidential business information, Imports, Reporting and recordkeeping requirements.

*40 CFR Part 1030*

Environmental protection, Air pollution control, Aircraft, Greenhouse gases.

*40 CFR Part 1031*

Environmental protection, Aircraft, confidential business information.

*40 CFR Part 1033*

Environmental protection, Administrative practice and procedure, Confidential business information, Environmental protection, Labeling, Penalties, Railroads, Reporting and recordkeeping requirements.

*40 CFR Part 1036*

Environmental protection, Administrative practice and procedure, Air pollution control, Confidential business information, Greenhouse gases, Incorporation by reference, Labeling, Motor vehicle pollution, Reporting and recordkeeping requirements, Warranties.

*40 CFR Part 1037*

Environmental protection, Administrative practice and procedure, Air pollution control, Confidential business information, Incorporation by reference, Labeling, Motor vehicle pollution, Reporting and recordkeeping requirements, Warranties.

*40 CFR Part 1039*

Environmental protection, Administrative practice and procedure, Air pollution control, Confidential business information, Imports, Labeling, Penalties, Reporting and recordkeeping requirements, Warranties.

*40 CFR Part 1042*

Environmental protection, Administrative practice and procedure, Air pollution control, Confidential business information, Environmental protection, Imports, Labeling, Penalties, Reporting and recordkeeping requirements, Vessels, Warranties.

*40 CFR Part 1043*

Environmental protection, Administrative practice and procedure, Air pollution control, Imports, Reporting and recordkeeping requirements, Vessels.

*40 CFR Part 1045*

Environmental protection, Administrative practice and procedure, Air pollution control, Confidential business information, Imports, Labeling, Penalties, Reporting and recordkeeping requirements, Warranties.

*40 CFR Part 1048*

Environmental protection, Administrative practice and procedure, Air pollution control, Confidential business information, Imports, Labeling, Penalties, Reporting and recordkeeping requirements, Research, Warranties.

*40 CFR Parts 1051 and 1054*

Environmental protection, Administrative practice and procedure, Air pollution control, Confidential business information, Imports, Labeling, Penalties, Reporting and recordkeeping requirements, Warranties.

*40 CFR Part 1060*

Environmental protection, Administrative practice and procedure, Air pollution control, Confidential business information, Imports, Incorporation by reference, Labeling, Penalties, Reporting and recordkeeping requirements, Warranties.

*40 CFR Part 1065*

Environmental protection, Administrative practice and procedure, Air pollution control, Incorporation by reference, Reporting and recordkeeping requirements, Research.

*40 CFR Part 1066*

Environmental protection, Air pollution control, Incorporation by reference, Reporting and recordkeeping requirements.

*40 CFR Part 1068*

Environmental protection, Administrative practice and procedure, Air pollution control, Confidential business information, Imports, Motor vehicle pollution, Penalties, Reporting

and recordkeeping requirements, Warranties.

*40 CFR Part 1090*

Environmental protection, Administrative practice and procedure, Air pollution control, Diesel fuel, Fuel additives, Gasoline, Imports, Oil imports, Petroleum, Renewable fuel.

**Michael S. Regan,**

*Administrator.*

For the reasons set out in the preamble, we are amending title 40, chapter I of the Code of Federal Regulations as set forth below.

**PART 2—PUBLIC INFORMATION**

■ 1. The authority citation for part 2 continues to read as follows:

**Authority:** 5 U.S.C. 552, 552a, 553; 28 U.S.C. 509, 510, 534; 31 U.S.C. 3717.

■ 2. Amend § 2.301 by adding and reserving paragraph (i) and adding paragraph (j) to read as follows:

**§ 2.301 Special rules governing certain information obtained under the Clean Air Act.**

\* \* \* \* \*

(j) *Requests for or release of information subject to a confidentiality determination through rulemaking as specified in 40 CFR part 1068.* This paragraph (j) describes provisions that apply for a wide range of engines, vehicles, and equipment that are subject to emission standards and other requirements under the Clean Air Act. This includes motor vehicles and motor vehicle engines, nonroad engines and nonroad equipment, aircraft and aircraft engines, and stationary engines. It also includes portable fuel containers regulated under 40 CFR part 59, subpart F, and fuel tanks, fuel lines, and related fuel-system components regulated under 40 CFR part 1060. Regulatory provisions related to confidentiality determinations for these products are codified broadly in 40 CFR part 1068, with additional detailed provisions for specific sectors in the regulatory parts referenced in 40 CFR 1068.1. References in this paragraph (j) to 40 CFR part 1068 also include these related regulatory parts.

(1) Unless noted otherwise, 40 CFR 2.201 through 2.215 do not apply for information covered by the confidentiality determinations in 40 CFR part 1068 if EPA has determined through rulemaking that information to be any of the following pursuant to 42 U.S.C. 7414 or 7542(c) in a rulemaking subject to 42 U.S.C. 7607(d):

(i) Emission data as defined in paragraph (a)(2)(i) of this section.

(ii) Data not entitled to confidential treatment.

(2) Unless noted otherwise, §§ 2.201 through 2.208 do not apply for information covered by the confidentiality determinations in 40 CFR part 1068 if EPA has determined through rulemaking that information to be entitled to confidential treatment pursuant to 42 U.S.C. 7414 or 7542(c) in a rulemaking subject to 42 U.S.C. 7607(d). EPA will treat such information as confidential in accordance with the provisions of §§ 2.209 through 2.215, subject to paragraph (j)(4) of this section.

(3) EPA will deny a request for information under 5 U.S.C. 552(b)(4) if EPA has determined through rulemaking that the information is entitled to confidential treatment under 40 CFR part 1068. The denial notification will include a regulatory cite to the appropriate determination.

(4) A determination made pursuant to 42 U.S.C. 7414 or 7542 in a rulemaking subject to 42 U.S.C. 7607(d) that information specified in 40 CFR part 1068 is entitled to confidential treatment shall continue in effect unless EPA takes one of the following actions to modify the determination:

(i) EPA determines, pursuant to 5 U.S.C. 552(b)(4) and the Clean Air Act (42 U.S.C. 7414; 7542(c)) in a rulemaking subject to 42 U.S.C. 7607(d), that the information is entitled to confidential treatment, or that the information is emission data or data that is otherwise not entitled to confidential treatment by statute or regulation.

(ii) EPA determines, pursuant to 5 U.S.C. 552(b)(4) and the Clean Air Act (42 U.S.C. 7414; 7542(c)) that the information is emission data or data that is otherwise clearly not entitled to confidential treatment by statute or regulation under 40 CFR 2.204(d)(2).

(iii) The Office of General Counsel revisits an earlier determination, pursuant to 5 U.S.C. 552(b)(4) and the Clean Air Act (42 U.S.C. 7414; 7542(c)), that the information is entitled to confidential treatment because of a change in the applicable law or newly discovered or changed facts. Prior to a revised final determination, EPA shall afford the business an opportunity to submit a substantiation on the pertinent issues to be considered, including any described in §§ 2.204(e)(4) or 2.205(b), within 15 days of the receipt of the notice to substantiate. If, after consideration of any timely comments made by the business in its substantiation, the Office of General Counsel makes a revised final determination that the information is not entitled to confidential treatment

under 42 U.S.C. 7414 or 7542, EPA will notify the business in accordance with § 2.205(f)(2).

(5) The provisions of 40 CFR 2.201 through 2.208 continue to apply for the categories of information identified in 40 CFR 1068.11(c) for which there is no confidentiality determination in 40 CFR part 1068.

#### **PART 59—NATIONAL VOLATILE ORGANIC COMPOUND EMISSION STANDARDS FOR CONSUMER AND COMMERCIAL PRODUCTS**

■ 3. The authority citation for part 59 continues to read as follows:

**Authority:** 42 U.S.C. 7414 and 7511(b)(e).

■ 4. Revise § 59.695 to read as follows:

##### **§ 59.695 What provisions apply to confidential information?**

The provisions of 40 CFR 1068.10 and 1068.11 apply for information you submit under this part.

#### **PART 60—STANDARDS OF PERFORMANCE FOR NEW STATIONARY SOURCES**

■ 5. The authority citation for part 60 continues to read as follows:

**Authority:** 42 U.S.C. 7401 *et seq.*

■ 6. Amend § 60.4202 by revising paragraph (g) introductory text to read as follows:

##### **§ 60.4202 What emission standards must I meet for emergency engines if I am a stationary CI internal combustion engine manufacturer?**

\* \* \* \* \*

(g) Notwithstanding the requirements in paragraphs (a) through (d) of this section, stationary emergency CI ICE identified in paragraphs (a) and (c) of this section may be certified to the provisions of 40 CFR part 1042 for commercial engines that are applicable for the engine's model year, displacement, power density, and maximum engine power if the engines will be used solely in either or both of the locations identified in paragraphs (g)(1) and (2) of this section. Engines that would be subject to the Tier 4 standards in 40 CFR part 1042 that are used solely in either or both of the locations identified in paragraphs (g)(1) and (2) of this section may instead continue to be certified to the previous tier of standards in 40 CFR part 1042. The previous tier is Tier 3 in most cases; however, the previous tier is Tier 2 if there are no Tier 3 standards specified for engines of a certain size or power rating.

\* \* \* \* \*

■ 7. Revise § 60.4218 to read as follows:

##### **§ 60.4218 What General Provisions and confidential information provisions apply to me?**

(a) Table 8 to this subpart shows which parts of the General Provisions in §§ 60.1 through 60.19 apply to you.

(b) The provisions of 40 CFR 1068.10 and 1068.11 apply for engine manufacturers. For others, the general confidential business information (CBI) provisions apply as described in 40 CFR part 2.

■ 8. Revise § 60.4246 to read as follows:

##### **§ 60.4246 What General Provisions and confidential information provisions apply to me?**

(a) Table 3 to this subpart shows which parts of the General Provisions in §§ 60.1 through 60.19 apply to you.

(b) The provisions of 40 CFR 1068.10 and 1068.11 apply for engine manufacturers. For others, the general confidential business information (CBI) provisions apply as described in 40 CFR part 2.

#### **PART 80—REGULATION OF FUELS AND FUEL ADDITIVES**

■ 9. The authority citation for part 80 continues to read as follows:

**Authority:** 42 U.S.C. 7414, 7521, 7542, 7545, and 7601(a).

#### **Subpart B [Removed and reserved]**

■ 10. Remove and reserve subpart B.

#### **PART 85—CONTROL OF AIR POLLUTION FROM MOBILE SOURCES**

■ 11. The authority citation for part 85 continues to read as follows:

**Authority:** 42 U.S.C. 7401–7671q.

■ 12. Amend § 85.1501 by revising paragraph (a) to read as follows:

##### **§ 85.1501 Applicability.**

(a) Except where otherwise indicated, this subpart is applicable to motor vehicles offered for importation or imported into the United States for which the Administrator has promulgated regulations under 40 CFR part 86, subpart D or S, prescribing emission standards, but which are not covered by certificates of conformity issued under section 206(a) of the Clean Air Act (*i.e.*, which are nonconforming vehicles as defined in § 85.1502), as amended, and part 86 at the time of conditional importation. Compliance with regulations under this subpart shall not relieve any person or entity from compliance with other applicable provisions of the Clean Air Act. This subpart no longer applies for heavy-duty engines certified under 40 CFR part 86,



subpart A, or 40 CFR part 1036; references in this subpart to “engines” therefore apply only for replacement engines intended for installation in motor vehicles that are subject to this subpart.

\* \* \* \* \*

**§ 85.1513 [Amended]**

■ 13. Amend § 85.1513 by removing and reserving paragraph (e)(5).

■ 14. Revise § 85.1514 to read as follows:

**§ 85.1514 Treatment of confidential information.**

The provisions of 40 CFR 1068.10 and 1068.11 apply for information you submit under this subpart.

■ 15. Amend § 85.1515 by revising paragraph (a)(2)(ii)(A) to read as follows:

**§ 85.1515 Emission standards and test procedures applicable to imported nonconforming motor vehicles and motor vehicle engines.**

- (a) \* \* \*
- (2) \* \* \*
- (ii) \* \* \*

(A) *Exhaust and fuel economy tests.* You must measure emissions over the FTP driving cycle and the highway fuel economy driving cycle as specified in 40 CFR 1066.801 to meet the fuel economy requirements in 40 CFR part 600 and demonstrate compliance with the exhaust emission standards in 40 CFR part 86 (other than PM). Measure exhaust emissions and fuel economy with the same test procedures used by the original manufacturer to test the vehicle for certification. However, you must use an electric dynamometer meeting the requirements of 40 CFR part 1066, subpart B, unless we approve a different dynamometer based on excessive compliance costs. If you certify based on testing with a different dynamometer, you must state in the application for certification that all vehicles in the emission family will comply with emission standards if tested on an electric dynamometer.

\* \* \* \* \*

■ 16. Amend § 85.1701 by revising paragraphs (a)(1), (b), and (c) to read as follows:

**§ 85.1701 General applicability.**

- (a) \* \* \*

(1) Beginning January 1, 2014, the exemption provisions of 40 CFR part 1068, subpart C, apply instead of the provisions of this subpart for heavy-duty motor vehicle engines and heavy-duty motor vehicles regulated under 40 CFR part 86, subpart A, 40 CFR part 1036, or 40 CFR part 1037, except that the nonroad competition exemption of

40 CFR 1068.235 and the nonroad hardship exemption provisions of 40 CFR 1068.245, 1068.250, and 1068.255 do not apply for motor vehicle engines. Note that the provisions for emergency vehicle field modifications in § 85.1716 continue to apply for heavy-duty engines.

\* \* \* \* \*

(b) The provisions of 40 CFR 1068.10 and 1068.11 apply for information you submit under this subpart.

(c) References to engine families and emission control systems in this subpart or in 40 CFR part 1068 apply to durability groups and test groups as applicable for manufacturers certifying vehicles under the provisions of 40 CFR part 86, subpart S.

\* \* \* \* \*

**§ 85.1712 [Removed and Reserved]**

■ 17. Remove and reserve § 85.1712.

■ 18. Revise § 85.1808 to read as follows:

**§ 85.1808 Treatment of confidential information.**

The provisions of 40 CFR 1068.10 and 1068.11 apply for information you submit under this subpart.

■ 19. Amend § 85.1901 by revising paragraph (a) to read as follows:

**§ 85.1901 Applicability.**

(a) The requirements of this subpart shall be applicable to all 1972 and later model year motor vehicles and motor vehicle engines, except that the provisions of 40 CFR 1068.501 apply instead for heavy-duty motor vehicle engines and heavy-duty motor vehicles certified under 40 CFR part 86, subpart A, or 40 CFR part 1036 or 1037 starting January 1, 2018.

\* \* \* \* \*

■ 20. Revise § 85.1909 to read as follows:

**§ 85.1909 Treatment of confidential information.**

The provisions of 40 CFR 1068.10 and 1068.11 apply for information you submit under this subpart.

■ 21. Revise the heading of subpart V to read as follows:

**Subpart V—Warranty Regulations and Voluntary Aftermarket Part Certification Program**

■ 22. Amend § 85.2102 by revising paragraphs (a)(1), (2), (4) through (6), (10), and (13) to read as follows:

**§ 85.2102 Definitions.**

- (a) \* \* \*

(1) *Act* means Part A of Title II of the Clean Air Act, 42 U.S.C. 7421 *et seq.*

(2) *Office Director* means the Director for the Office of Transportation and Air Quality in the Office of Air and Radiation of the Environmental Protection Agency or other authorized representative of the Office Director.

\* \* \* \* \*

(4) *Emission performance warranty* means that warranty given pursuant to this subpart and 42 U.S.C. 7541(b).

(5) *Emission warranty* means a warranty given pursuant to this subpart and 42 U.S.C. 7541(a) or (b).

(6) *Model year* means the manufacturer’s annual production period as described in subpart X of this part.

\* \* \* \* \*

(10) *Useful life* means that period established pursuant to 42 U.S.C. 7521(d) and regulations promulgated thereunder.

\* \* \* \* \*

(13) *Written instructions for proper maintenance and use* means those maintenance and operation instructions specified in the owner’s manual as being necessary to assure compliance of a vehicle with applicable emission standards for the useful life of the vehicle that are:

(i) In accordance with the instructions specified for performance on the manufacturer’s prototype vehicle used in certification (including those specified for vehicles used under special circumstances); and

(ii) In compliance with the requirements of 40 CFR 86.1808; and

(iii) In compliance with any other EPA regulations governing maintenance and use instructions.

\* \* \* \* \*

■ 23. Amend § 85.2103 by revising paragraph (a)(3) to read as follows:

**§ 85.2103 Emission performance warranty.**

- (a) \* \* \*

(3) Such nonconformity results or will result in the vehicle owner having to bear any penalty or other sanction (including the denial of the right to use the vehicle) under local, State or Federal law, then the manufacturer shall remedy the nonconformity at no cost to the owner; except that, if the vehicle has been in operation for more than 24 months or 24,000 miles, the manufacturer shall be required to remedy only those nonconformities resulting from the failure of any of the specified major emission control components listed in 42 U.S.C. 7541(i)(2) or components which have been designated by the Administrator under 42 U.S.C. 7541(i)(2) to be specified major emission control

components until the vehicle has been in operation for 8 years or 80,000 miles.  
\* \* \* \*

■ 24. Amend § 85.2104 by revising paragraphs (a) and (h) introductory text to read as follows:

**§ 85.2104 Owners' compliance with instructions for proper maintenance and use.**

(a) An emission warranty claim may be denied on the basis of noncompliance by a vehicle owner with the written instructions for proper maintenance and use.  
\* \* \* \*

(h) In no case may a manufacturer deny an emission warranty claim on the basis of—  
\* \* \* \*

■ 25. Amend § 85.2106 by revising paragraphs (b) introductory text, (c), (d) introductory text, (d)(2), and (g) to read as follows:

**§ 85.2106 Warranty claim procedures.**

(b) A claim under any emission warranty required by 42 U.S.C. 7541(a) or (b) may be submitted by bringing a vehicle to:  
\* \* \* \*

(c) To the extent required by any Federal or State law, whether statutory or common law, a vehicle manufacturer shall be required to provide a means for non-franchised repair facilities to perform emission warranty repairs.

(d) The manufacturer of each vehicle to which the warranty is applicable shall establish procedures as to the manner in which a claim under the emission warranty is to be processed. The procedures shall—  
\* \* \* \*

(2) Require that if the facility at which the vehicle is initially presented for repair is unable for any reason to honor the particular claim, then, unless this requirement is waived in writing by the vehicle owner, the repair facility shall forward the claim to an individual or office authorized to make emission warranty determinations for the manufacturer.  
\* \* \* \*

(g) The vehicle manufacturer shall incur all costs associated with a determination that an emission warranty claim is valid.

■ 26. Amend § 85.2107 by revising paragraphs (a) and (b) to read as follows:

**§ 85.2107 Warranty remedy.**

(a) The manufacturer's obligation under the emission warranties provided under 42 U.S.C. 7541(a) and (b) shall be to make all adjustments, repairs or

replacements necessary to assure that the vehicle complies with applicable emission standards of the U.S. Environmental Protection Agency, that it will continue to comply for the remainder of its useful life (if proper maintenance and operation are continued), and that it will operate in a safe manner. The manufacturer shall bear all costs incurred as a result of the above obligation, *except that* after the first 24 months or 24,000 miles (whichever first occurs) the manufacturer shall be responsible only for:

(1) The adjustment, repair or replacement of any of the specified major emission control components listed in 42 U.S.C. 7541(i)(2) or components which have been designated by the administrator to be specified major emission control components until the vehicle has been in operation for 8 years or 80,000 miles; and

(2) All other components which must be adjusted, repaired or replaced to enable a component adjusted, repaired, or replaced under paragraph (a)(1) of this section to perform properly.

(b) Manufacturers shall be liable for the total cost of the remedy for any vehicle validly presented for repair under an emission warranty to any authorized service facility authorized by the vehicle manufacturer. State or local limitations as to the extent of the penalty or sanction imposed upon an owner of a failed vehicle shall have no bearing on this liability.  
\* \* \* \*

■ 27. Amend § 85.2109 by revising paragraphs (a) introductory text and (a)(6) to read as follows:

**§ 85.2109 Inclusion of warranty provisions in owners' manuals and warranty booklets.**

(a) A manufacturer shall furnish with each new motor vehicle, a full explanation of the emission warranties required by 42 U.S.C. 7541(a) and (b), including at a minimum the following information:  
\* \* \* \*

(6) An explanation that an owner may obtain further information concerning the emission warranties or that an owner may report violations of the terms of the emission warranties provided under 42 U.S.C. 7541(a) and (b) by contacting the Director, Compliance Division, Environmental Protection Agency, 2000 Traverwood Dr, Ann Arbor, MI 48105 (Attention: Warranty) or email to: *complianceinfo@epa.gov*.  
\* \* \* \*

■ 28. Amend § 85.2111 by revising the introductory text and paragraphs (b) introductory text, (c), and (d) to read as follows:

**§ 85.2111 Warranty enforcement.**

The following acts are prohibited and may subject a manufacturer to a civil penalty as described in paragraph (d) of this section:  
\* \* \* \*

(b) Failing or refusing to comply with the terms and conditions of the emission warranties provided under 42 U.S.C. 7541(a) and (b) with respect to any vehicle to which this subpart applies. Acts constituting such a failure or refusal shall include, but are not limited to, the following:  
\* \* \* \*

(c) To provide directly or indirectly in any communication to the ultimate purchaser or any subsequent purchaser that emission warranty coverage is conditioned upon the use of any name brand component, or system or upon service (other than a component or service provided without charge under the terms of the purchase agreement), unless the communication is made pursuant to a written waiver by the Office Director.

(d) The maximum penalty value is \$37,500 for each offense that occurs after November 2, 2015. Maximum penalty limits may be adjusted based on the Consumer Price Index as described at 40 CFR part 19.  
\* \* \* \*

■ 29. Revise § 85.2123 to read as follows:

**§ 85.2123 Treatment of confidential information.**

The provisions of 40 CFR 1068.10 and 1068.11 apply for information you submit under this subpart.

■ 30. Revise the heading for subpart W to read as follows:

**Subpart W—Emission Control System Performance Warranty Tests**

**PART 86—CONTROL OF EMISSIONS FROM NEW AND IN-USE HIGHWAY VEHICLES AND ENGINES**

■ 31. The authority citation for part 86 continues to read as follows:

**Authority:** 42 U.S.C. 7401–7671q.

■ 32. Amend § 86.007–11 by revising paragraphs (f) and (g) introductory text to read as follows:

**§ 86.007–11 Emission standards and supplemental requirements for 2007 and later model year diesel heavy-duty engines and vehicles.**  
\* \* \* \*

(f) Model year 2007 and later diesel-fueled heavy-duty engines and vehicles for sale in Guam, American Samoa, or the Commonwealth of the Northern Mariana Islands may be subject to alternative standards under 40 CFR 1036.655.

(g) Model years 2018 through 2026 engines at or above 56 kW that will be installed in specialty vehicles as allowed by 40 CFR 1037.605 may meet alternate emission standards as follows:

\* \* \* \* \*

■ 33. Amend § 86.008–10 by revising paragraph (g) introductory text to read as follows:

**§ 86.008–10 Emission standards for 2008 and later model year Otto-cycle heavy-duty engines and vehicles.**

\* \* \* \* \*

(g) Model years 2018 through 2026 engines that will be installed in specialty vehicles as allowed by 40 CFR 1037.605 may meet alternate emission standards as follows:

\* \* \* \* \*

■ 34. Amend § 86.010–18 by:

■ a. Revising paragraph (a) introductory text.

■ b. Removing and reserving paragraph (o).

The revision reads as follows:

**§ 86.010–18 On-board Diagnostics for engines used in applications greater than 14,000 pounds GVWR.**

(a) *General.* Heavy-duty engines intended for use in a heavy-duty vehicle weighing more than 14,000 pounds GVWR must be equipped with an on-board diagnostic (OBD) system capable of monitoring all emission-related engine systems or components during the life of the engine. The OBD requirements of 40 CFR 1036.110 apply starting in model year 2027. In earlier model years, manufacturers may meet the requirements of this section or the requirements of 40 CFR 1036.110. Note that 40 CFR 1036.150(v) allows for an alternative communication protocol before model year 2027. The OBD system is required to detect all malfunctions specified in paragraphs

(g), (h), and (i) of this section even though the OBD system is not required to use a unique monitor to detect each of those malfunctions.

\* \* \* \* \*

■ 35. Amend § 86.016–1 by:

■ a. Revising paragraphs (a) introductory text, (d) introductory text, and (d)(4).

■ b. Adding and reserving paragraph (i) adding paragraph (j).

The revisions and additions read as follows:

**§ 86.016–1 General applicability.**

(a) *Applicability.* The provisions of this subpart apply for certain types of new heavy-duty engines and vehicles as described in this section. As described in paragraph (j) of this section, most of this subpart no longer applies starting with model year 2027. Note that this subpart does not apply for light-duty vehicles, light-duty trucks, medium-duty passenger vehicles, or vehicles at or below 14,000 pounds GVWR that have no propulsion engine, such as electric vehicles; see subpart S of this part for requirements that apply for those vehicles. In some cases, manufacturers of heavy-duty engines and vehicles can choose to meet the requirements of this subpart or the requirements of subpart S of this part; those provisions are therefore considered optional, but only to the extent that manufacturers comply with the other set of requirements. In cases where a provision applies only for a certain vehicle group based on its model year, vehicle class, motor fuel, engine type, or other distinguishing characteristics, the limited applicability is cited in the appropriate section. The provisions of this subpart apply for certain heavy-duty engines and vehicles as follows:

\* \* \* \* \*

(d) *Non-petroleum fueled vehicles.* Standards and requirements apply to model year 2016 and later non-petroleum fueled motor vehicles as follows:

\* \* \* \* \*

(4) The standards and requirements of 40 CFR part 1037 apply for vehicles above 14,000 pounds GVWR that have no propulsion engine, such as electric vehicles. Electric heavy-duty vehicles may not generate PM emission credits. Electric heavy-duty vehicles may not generate NO<sub>x</sub> emission credits except as allowed under 40 CFR part 1037.

\* \* \* \* \*

(j) *Transition to 40 CFR parts 1036 and 1037.* Except for § 86.010–38(j), this subpart no longer applies starting with model year 2027. Individual provisions in 40 CFR parts 1036 and 1037 apply instead of the provisions of this subpart before model year 2027 as specified in this subpart and 40 CFR parts 1036 and 1037.

■ 36. Amend § 86.090–5 by adding paragraph (b)(4) to read as follows.

**§ 86.090–5 General standards; increase in emissions; unsafe conditions.**

\* \* \* \* \*

(b) \* \* \*

(4) Manufacturers of engines equipped with vanadium-based SCR catalysts must design the engine and its emission controls to prevent vanadium sublimation and protect the catalyst from high temperatures as described in 40 CFR 1036.115(g)(2).

■ 37. Amend § 86.117–96 by revising paragraphs (d)(1) to read as follows.

**§ 86.117–96 Evaporative emission enclosure calibrations.**

\* \* \* \* \*

(d) \* \* \*

(1) The calculation of net methanol and hydrocarbon mass change is used to determine enclosure background and leak rate. It is also used to check the enclosure volume measurements. The methanol mass change is calculated from the initial and final methanol samples, the net withdrawn methanol (in the case of diurnal emission testing with fixed-volume enclosures), and initial and final temperature according to the following equation:

$$M_{CH_3OH} = V_n \times \left( \frac{TE_f \times ((C_{MS1f} \times AV_{1f}) + (C_{MS2f} \times AV_{2f}))}{V_{Ef} \times T_{SHEDf}} - \frac{TE_i \times ((C_{MS1i} \times AV_{1i}) + (C_{MS2i} \times AV_{2i}))}{V_{Ei} \times T_{SHEDI}} \right) + (M_{CH_3OH,out} - M_{CH_3OH,in})$$

Where:

$M_{CH_3OH}$  = Methanol mass change, µg.  
 $V_n$  = Enclosure volume, in ft<sup>3</sup>, as measured in paragraph (b)(1) of this section.

$TE$  = Temperature of sample withdrawn, R.  
 $f$  = Final sample.  
 $C_{MS}$  = GC concentration of test sample.  
 $1$  = First impinger.

$AV$  = Volume of absorbing reagent in impinger (ml).  
 $2$  = Second impinger.

$V_E$  = Volume of sample withdrawn, ft<sup>3</sup>.  
 Sample volumes must be corrected for differences in temperature to be consistent with determination of  $V_n$ , prior to being used in the equation.

$T_{SHED}$  = Temperature of SHED, R.  
*i* = Initial sample.

$M_{CH_3OH,out}$  = mass of methanol exiting the enclosure, in the case of fixed volume enclosures for diurnal emission testing, µg.

$M_{CH_3OH,in}$  = mass of methanol exiting the enclosure, in the case of fixed volume enclosures for diurnal emission testing, µg.

\* \* \* \* \*

■ 38. Amend § 86.137–94 by revising paragraph (b)(24) to read as follows.

$$M_{CH_3OH} = V_n \times \left( \frac{TE_f \times ((C_{MS1f} \times AV_{1f}) + (C_{MS2f} \times AV_{2f}))}{V_{Ef} \times T_{SHEDf}} - \frac{TE_i \times ((C_{MS1i} \times AV_{1i}) + (C_{MS2i} \times AV_{2i}))}{V_{Ei} \times T_{SHEDi}} \right) + (M_{CH_3OH,out} - M_{CH_3OH,in})$$

Where:

$M_{CH_3OH}$  = Methanol mass change, µg.  
 $V_n$  = Net enclosure volume, ft<sup>3</sup>, as determined by subtracting 50 ft<sup>3</sup> (volume of vehicle with trunk and windows open) from the enclosure volume. A manufacturer may use the measured volume of the vehicle (instead of the nominal 50 ft<sup>3</sup>) with advance approval by the Administrator: *Provided*, the measured volume is determined and used for all vehicles tested by that manufacturer.

$TE$  = Temperature of sample withdrawn, R.  
*f* = Final sample.

$C_{MS}$  = GC concentration of sample, µg/ml.

1 = First impinger.

$AV$  = Volume of absorbing reagent in impinger.

2 = Second impinger.

$V_E$  = Volume of sample withdrawn, ft<sup>3</sup>.  
 Sample volumes must be corrected for differences in temperature to be consistent with determination of  $V_n$ , prior to being used in the equation.

$T_{SHED}$  = Temperature of SHED, R.

*i* = Initial sample.

$M_{CH_3OH,out}$  = mass of methanol exiting the enclosure, in the case of fixed-volume enclosures for diurnal emission testing, µg.

$M_{CH_3OH,in}$  = mass of methanol entering the enclosure, in the case of fixed-volume enclosures for diurnal emission testing, µg.

\* \* \* \* \*

■ 40. Amend § 86.154–98 by revising paragraph (e)(9) to read as follows.

**§ 86.154–98 Measurement procedure; refueling test.**

\* \* \* \* \*

(e) \* \* \*

(9) For vehicles equipped with more than one fuel tank, use good engineering judgment to apply the procedures

**§ 86.137–94 Dynamometer test run, gaseous and particulate emissions.**

\* \* \* \* \*

(b) \* \* \*

(24) This completes the test sequence for vehicles that do not need testing for evaporative emissions. Continue testing for evaporative emissions as follows:

(i) For the three-day diurnal test sequence, proceed according to § 86.134.

(ii) For the two-day diurnal test sequence, proceed according to § 86.138–96(k). The following additional provisions apply for heavy-duty vehicles:

(A) For vehicles with a nominal fuel tank capacity at or above 50 gallons, operate the vehicle over a second full FTP cycle before measuring evaporative emissions; exhaust emission measurement is not required for the additional FTP cycle.

(B) [Reserved]

■ 39. Amend § 86.143–96 by revising paragraph (b)(1)(i) to read as follows.

**§ 86.143–96 Calculations; evaporative emissions.**

\* \* \* \* \*

(b) \* \* \*

(1) \* \* \*

(i) Methanol emissions:

calculated in accordance with § 86.1112–87(a)].”

(3) If a manufacturer introduces an engine or vehicle into U.S. commerce prior to the compliance level determination of § 86.1112–87(a), it must provide the engine or vehicle owner with a label as described in paragraph (a)(2) of this section to be affixed in a location in proximity to the emission control information label within 30 days of the completion of the PCA.

(b) The Administrator may approve in advance other label content and formats, provided the alternative label contains information consistent with this section.

■ 44. Revise § 86.1301 to read as follows:

**§ 86.1301 Scope; applicability.**

(a) This subpart specifies gaseous emission test procedures for Otto-cycle and diesel heavy-duty engines, and particulate emission test procedures for diesel heavy-duty engines.

(b) You may optionally demonstrate compliance with the emission standards of this part by testing hybrid engines and hybrid powertrains using the test procedures in 40 CFR part 1036, rather than testing the engine alone. If you choose this option, you may meet the supplemental emission test (SET) requirements by using the SET duty cycle specified in either § 86.1362 or 40 CFR 1036.510. Except as specified, provisions of this subpart and subpart A of this part that reference engines apply equally to hybrid engines and hybrid powertrains.

described in this section for each fuel tank.

■ 41. Add § 86.450 to subpart E to read as follows:

**§ 86.450 Treatment of confidential information.**

The provisions of 40 CFR 1068.10 and 1068.11 apply for information you submit under this subpart.

**Subpart I [Removed and Reserved]**

■ 42. Subpart I, consisting of §§ 86.1101–87 through 86.1116–87, is removed and reserved.

■ 43. Add § 86.1117 to subpart L to read as follows:

**§ 86.1117 Labeling.**

(a) Light-duty trucks and heavy-duty vehicles and engines for which nonconformance penalties are to be paid in accordance with § 86.1113–87(b) must have information printed on the emission control information label or a supplemental label as follows.

(1) The manufacturer must begin labeling production engines or vehicles within 10 days after the completion of the PCA.

(2) This statement shall read: “The manufacturer of this [engine or vehicle, as applicable] will pay a nonconformance penalty to be allowed to introduce it into U.S. commerce at an emission level higher than the applicable emission standard. The [compliance level or alternative emission standard] for this engine/vehicle is [insert the applicable pollutant and compliance level

(c) The abbreviations and acronyms from subpart A of this part apply to this subpart.

**§§ 86.1302–84, 86.1303–84, and 86.1304 [Removed]**

■ 45. Remove §§ 86.1302–84, 86.1303–84, and 86.1304.

■ 46. Amend § 86.1362 by revising paragraph (b) to read as follows:

**§ 86.1362 Steady-state testing with a ramped-modal cycle.**

\* \* \* \* \*

(b) Measure emissions by testing the engine on a dynamometer with the

following ramped-modal duty cycle to determine whether it meets the applicable steady-state emission standards in this part and 40 CFR part 1036:

**BILLING CODE 6560–50–P**

Table 1 of § 86.1362—Ramped-Modal Duty Cycle

RMC Mode	Engine testing			Hybrid powertrain testing									CO <sub>2</sub> weighting (percent) <sup>5</sup>
	Time in mode (seconds)	Engine Speed <sup>1,2</sup>	Torque <sup>2,3</sup> (percent)	Vehicle speed <sup>4</sup> (mi/hr)	Road-grade coefficients <sup>4</sup>								
					a	b	c	d	e	f	g	h	
1a Steady-state	170	Warm Idle	0	0	0	0	0	0	0	0	0	0	6
1b Transition	20	Linear Transition	Linear Transition	Linear Transition	-1.90E-08	-5.90E-07	3.78E-05	4.71E-03	6.55E-04	-2.68E-02	-1.03E+00	1.54E+01	
2a Steady-state	173	A	100	v <sub>refA</sub>	-1.24E-08	-5.51E-07	3.95E-05	1.25E-03	5.29E-04	-3.12E-02	-3.26E-01	1.63E+01	9
2b Transition	20	Linear Transition	Linear Transition	Linear Transition	-1.64E-09	-4.90E-07	2.49E-05	5.70E-04	4.77E-04	-2.39E-02	-2.71E-01	1.21E+01	
3a Steady-state	219	B	50	v <sub>refB</sub>	8.34E-09	-4.76E-07	1.29E-05	2.87E-04	4.53E-04	-1.80E-02	-1.83E-01	8.81E+00	10
3b Transition	20	B	Linear Transition	v <sub>refB</sub>	4.26E-09	-5.10E-07	2.01E-05	3.70E-04	4.85E-04	-2.24E-02	-2.07E-01	1.07E+01	
4a Steady-state	217	B	75	v <sub>refB</sub>	1.69E-10	-5.23E-07	2.58E-05	5.52E-04	5.01E-04	-2.56E-02	-2.39E-01	1.29E+01	10
4b Transition	20	Linear Transition	Linear Transition	Linear Transition	6.56E-10	-4.97E-07	2.23E-05	5.29E-04	4.63E-04	-2.19E-02	-1.82E-01	1.09E+01	
5a Steady-state	103	A	50	v <sub>refA</sub>	3.83E-09	-4.34E-07	1.37E-05	4.76E-04	4.15E-04	-1.61E-02	-1.90E-01	8.20E+00	12
5b Transition	20	A	Linear Transition	v <sub>refA</sub>	-7.53E-11	-4.68E-07	2.04E-05	7.21E-04	4.48E-04	-2.01E-02	-2.31E-01	1.04E+01	
6a Steady-state	100	A	75	v <sub>refA</sub>	-4.20E-09	-4.86E-07	2.62E-05	8.35E-04	4.67E-04	-2.34E-02	-2.55E-01	1.22E+01	12
6b Transition	20	A	Linear Transition	v <sub>refA</sub>	3.19E-09	-4.55E-07	1.55E-05	6.22E-04	4.31E-04	-1.72E-02	-2.09E-01	8.91E+00	
7a Steady-state	103	A	25	v <sub>refA</sub>	1.20E-08	-3.77E-07	6.94E-07	1.11E-04	3.58E-04	-8.47E-03	-1.24E-01	4.20E+00	12
7b Transition	20	Linear Transition	Linear Transition	Linear Transition	1.48E-09	-5.00E-07	2.15E-05	6.03E-04	4.77E-04	-2.20E-02	-2.67E-01	1.11E+01	
8a Steady-state	194	B	100	v <sub>refB</sub>	-8.17E-09	-5.68E-07	3.88E-05	8.17E-04	5.46E-04	-3.32E-02	-2.96E-01	1.69E+01	9
8b Transition	20	B	Linear Transition	v <sub>refB</sub>	3.53E-09	-5.29E-07	2.22E-05	4.96E-04	4.98E-04	-2.36E-02	-2.25E-01	1.16E+01	
9a Steady-state	218	B	25	v <sub>refB</sub>	1.67E-08	-4.29E-07	-1.39E-07	2.17E-05	4.06E-04	-1.05E-02	-1.27E-01	4.76E+00	9
9b Transition	20	Linear Transition	Linear Transition	Linear Transition	7.24E-09	-5.50E-07	2.00E-05	1.38E-04	5.11E-04	-2.33E-02	-2.15E-01	1.02E+01	
10a Steady-state	171	C	100	v <sub>refC</sub>	-7.51E-10	-5.93E-07	3.45E-05	5.07E-04	5.67E-04	-3.35E-02	-2.65E-01	1.65E+01	2
10b Transition	20	C	Linear Transition	v <sub>refC</sub>	1.06E-08	-5.34E-07	1.68E-05	2.59E-04	5.10E-04	-2.33E-02	-2.02E-01	1.12E+01	
11a Steady-state	102	C	25	v <sub>refC</sub>	2.24E-08	-4.76E-07	-2.08E-06	-6.01E-05	4.51E-04	-1.21E-02	-1.26E-01	5.09E+00	1
11b Transition	20	C	Linear Transition	v <sub>refC</sub>	1.55E-08	-5.42E-07	1.11E-05	8.44E-05	5.05E-04	-2.01E-02	-1.68E-01	8.73E+00	
12a Steady-state	100	C	75	v <sub>refC</sub>	7.16E-09	-5.57E-07	2.23E-05	3.11E-04	5.30E-04	-2.64E-02	-2.18E-01	1.27E+01	1
12b Transition	20	C	Linear Transition	v <sub>refC</sub>	9.91E-09	-5.29E-07	1.69E-05	2.46E-04	5.06E-04	-2.30E-02	-1.99E-01	1.10E+01	
13a Steady-state	102	C	50	v <sub>refC</sub>	1.47E-08	-5.12E-07	9.88E-06	1.00E-04	4.86E-04	-1.90E-02	-1.68E-01	8.74E+00	1
13b Transition	20	Linear Transition	Linear Transition	Linear Transition	-1.48E-09	-1.99E-06	6.48E-05	-1.39E-02	1.23E-03	-3.97E-02	1.14E+00	-7.27E+00	
14 Steady-state	168	Warm Idle	0	0	0	0	0	0	0	0	0	6	

<sup>1</sup>Engine speed terms are defined in 40 CFR part 1065.

<sup>2</sup>Advance from one mode to the next within a 20 second transition phase. During the transition phase, command a linear progression from the settings of the current mode to the settings of the next mode.

<sup>3</sup>The percent torque is relative to maximum torque at the commanded engine speed.

<sup>4</sup>See 40 CFR 1036.510(c) for a description of powertrain testing with the ramped-modal cycle, including the equation that uses the road-grade coefficients.

<sup>5</sup>Use the specified weighting factors to calculate composite emission results for CO<sub>2</sub> as specified in 40 CFR 1036.150.

BILLING CODE 6560-50-C

■ 47. Amend § 86.1372 by revising paragraph (a) introductory text to read as follows:

§ 86.1372 Measuring smoke emissions within the NTE zone.

\* \* \* \* \*

(a) For steady-state or transient smoke testing using full-flow opacimeters, use equipment meeting the requirements of 40 CFR part 1065, subpart L.

\* \* \* \* \*

■ 48. Amend § 86.1801-12 by revising paragraphs (a) introductory text, (a)(2)(iii), (a)(3) introductory text, (a)(3)(iii) and (iv), (b), and (g) to read as follows:

§ 86.1801-12 Applicability.

(a) Applicability. The provisions of this subpart apply to certain types of new vehicles as described in this paragraph (a). Where the provisions apply for a type of vehicle, they apply for vehicles powered by any fuel, unless otherwise specified. In cases where a provision applies only to a certain vehicle group based on its model year, vehicle class, motor fuel, engine type, or other distinguishing characteristics, the limited applicability is cited in the appropriate section. Testing references in this subpart generally apply to Tier 2 and older vehicles, while testing references to 40 CFR part 1066 generally apply to Tier 3 and newer vehicles; see § 86.101 for detailed provisions related to this transition. The provisions of this subpart apply to certain vehicles as follows:

\* \* \* \* \*

(2) \* \* \*

(iii) The provisions of this subpart are optional for diesel-fueled Class 3 heavy-duty vehicles in a given model year if those vehicles are equipped with engines certified to the appropriate standards in § 86.007-11 or 40 CFR 1036.104 for which less than half of the engine family's sales for the model year in the United States are for complete Class 3 heavy-duty vehicles. This includes engines sold to all vehicle manufacturers. If you are the original manufacturer of the engine and the vehicle, base this showing on your sales information. If you manufacture the vehicle but are not the original manufacturer of the engine, you must use your best estimate of the original manufacturer's sales information.

(3) The provisions of this subpart generally do not apply to incomplete heavy-duty vehicles of any size, or to complete vehicles above 14,000 pounds GVWR (see § 86.016-1 and 40 CFR parts 1036 and 1037). However, this subpart

applies to such vehicles in the following cases:

\* \* \* \* \*

(iii) The evaporative emission standards apply for incomplete heavy-duty vehicles at or below 14,000 pounds GVWR.

(iv) Evaporative and refueling emission standards apply for complete and incomplete heavy-duty vehicles above 14,000 pounds GVWR as specified in 40 CFR 1037.103.

\* \* \* \* \*

(b) Relationship to 40 CFR parts 1036 and 1037. If any heavy-duty vehicle is not subject to standards and certification requirements under this subpart, the vehicle and its installed engine are instead subject to standards and certification requirements under 40 CFR parts 1036 and 1037, as applicable. If you optionally certify engines or vehicles to standards under 40 CFR part 1036 or 40 CFR part 1037, respectively, those engines or vehicles are subject to all the regulatory requirements in 40 CFR parts 1036 and 1037 as if they were mandatory. Note that heavy-duty engines subject to greenhouse gas standards under 40 CFR part 1036 before model year 2027 are also subject to standards and certification requirements under 40 CFR part 86, subpart A.

\* \* \* \* \*

(g) Complete and incomplete vehicles. Several provisions in this subpart, including the applicability provisions described in this section, are different for complete and incomplete vehicles. We differentiate these vehicle types as described in 40 CFR 1037.801.

\* \* \* \* \*

■ 49. Amend § 86.1806-17 by adding paragraphs (a)(9) and (b)(4) to read as follows:

§ 86.1806-17 Onboard diagnostics.

\* \* \* \* \*

(a) \* \* \*

(9) Apply thresholds as specified in 40 CFR 1036.110(b)(5) for engines certified to emission standards under 40 CFR part 1036.

(b) \* \* \*

(4) For vehicles with installed compression-ignition engines that are subject to standards and related requirements under 40 CFR 1036.104 and 1036.111, you must comply with the following additional requirements:

(i) Make parameters related to engine derating and other inducements available for reading with a generic scan tool as specified in 40 CFR 110(b)(9)(vi).

(ii) Design your vehicles to display information 1036.related to engine derating and other inducements in the

cab as specified in 40 CFR 1036.110(c)(1).

\* \* \* \* \*

■ 50. Amend § 86.1810-17 by adding paragraphs (j) and (k) to read as follows:

§ 86.1810-17 General requirements.

\* \* \* \* \*

(j) Small-volume manufacturers that modify a vehicle already certified by a different company may recertify that vehicle under this subpart S based on the vehicle supplier's compliance with fleet average standards for criteria exhaust emissions, evaporative emissions, and greenhouse gas emissions as follows:

(1) The recertifying manufacturer must certify the vehicle at bin levels and family emission limits that are the same as or more stringent than the corresponding bin levels and family emission limits for the vehicle supplier.

(2) The recertifying manufacturer must meet all the standards and requirements described in this subpart S, except for the fleet average standards for criteria exhaust emissions, evaporative emissions, and greenhouse gas emissions.

(3) The vehicle supplier must send the small-volume manufacturer a written statement accepting responsibility to include the subject vehicles in the vehicle supplier's exhaust and evaporative fleet average calculations in §§ 86.1860-17, 86.1864-10, and 86.1865-12.

(4) The small-volume manufacturer must describe in the application for certification how the two companies are working together to demonstrate compliance for the subject vehicles. The application must include the statement from the vehicle supplier described in paragraph (j)(3) of this section.

(5) The vehicle supplier must include a statement that the vehicle supplier is including the small volume manufacturer's sales volume and emissions levels in the vehicle supplier's fleet average reports under §§ 86.1860-17, 86.1864-10, and 86.1865-12.

(k) Gasoline-fueled vehicles must have a restriction in the tank filler inlet that allows inserting nozzles meeting the specifications of 40 CFR 1090.1550(a), but not nozzles with an outside diameter greater than 2.3 centimeters.

■ 51. Amend § 86.1813-17 by revising paragraphs (a)(2)(iii) and (b) to read as follows:

§ 86.1813-17 Evaporative and refueling emission standards.

\* \* \* \* \*

(a) \* \* \*

(2) \* \* \*

(iii) Hydrocarbon emissions must not exceed 0.020 g for LDV and LDT and 0.030 g for HDV when tested using the Bleed Emission Test Procedure adopted by the California Air Resources Board as part of the LEV III program. This procedure quantifies diurnal emissions using the two-diurnal test sequence without measuring hot soak emissions. For heavy-duty vehicles with a nominal fuel tank capacity at or above 50 gallons, operate the vehicle over a second full FTP cycle before measuring diurnal emissions. The standards in this paragraph (a)(2)(iii) do not apply for testing at high-altitude conditions. For vehicles with non-integrated refueling canisters, the bleed emission test and standard do not apply to the refueling canister. You may perform the Bleed Emission Test Procedure using the analogous test temperatures and the E10 test fuel specified in subpart B of this part.

\* \* \* \* \*

(b) *Refueling emissions.* Light-duty vehicles, light-duty trucks, and heavy-duty vehicles must meet the refueling emission standards in this paragraph (b) as follows when measured over the procedure specified in § 86.150:

(1) The following implementation dates apply for incomplete vehicles:

(i) Refueling standards apply starting with model year 2027 for incomplete vehicles certified under 40 CFR part 1037, unless the manufacturer complies with the alternate phase-in specified in paragraph (b)(1)(iii) of this section. If you do not meet the alternative phase-in requirement for model year 2026, you must certify all your incomplete heavy-duty vehicles above 14,000 pounds GVWR to the refueling standard in model year 2027.

(ii) Refueling standards are optional for incomplete heavy-duty vehicles at or below 14,000 pounds GVWR, unless the manufacturer uses the alternate phase-in specified in paragraph (b)(1)(iii) of this section to meet standards together for heavy-duty vehicles above and below 14,000 pounds GVWR.

(iii) Manufacturers may comply with an alternate phase-in of the refueling standard for incomplete heavy-duty vehicles as described in this paragraph (b)(1)(iii). Manufacturers must meet the refueling standard during the phase-in based on their projected nationwide production volume of all incomplete heavy-duty vehicles subject to standards under this subpart and under 40 CFR part 1037 as described in Table 4 of this section. Keep records as needed to show that you meet phase-in requirements.

TABLE 4 OF § 86.1813–17—ALTERNATIVE PHASE-IN SCHEDULE FOR REFUELING EMISSION STANDARDS FOR INCOMPLETE HEAVY-DUTY VEHICLES

Model year	Minimum percentage of vehicles subject to the refueling standard
2026 .....	40
2027 .....	40
2028 .....	80
2029 .....	80
2030 .....	100

(2) The following refueling standards apply:

(i) 0.20 g THCE per gallon of fuel dispensed for vehicles using volatile liquid fuels. This standard also applies for diesel-fueled LDV.

(ii) 0.15 g THC per gallon of fuel dispensed for liquefied petroleum gas-fueled vehicles and natural gas-fueled vehicles.

\* \* \* \* \*

**§ 86.1819 [Removed]**

- 52. Remove § 86.1819.
- 53. Amend § 86.1819–14 by revising paragraph (d)(12)(i) to read as follows:

**§ 86.1819–14 Greenhouse gas emission standards for heavy-duty vehicles.**

\* \* \* \* \*

- (d) \* \* \*
- (12) \* \* \*

(i) *Configuration* means a subclassification within a test group based on engine code, transmission type and gear ratios, final drive ratio, and other parameters we designate. Engine code means the combination of both “engine code” and “basic engine” as defined for light-duty vehicles in 40 CFR 600.002.

\* \* \* \* \*

- 54. Amend § 86.1821–01 by revising paragraph (a) and adding paragraph (g) to read as follows:

**§ 86.1821–01 Evaporative/refueling family determination.**

(a) The gasoline-, ethanol-, methanol-, liquefied petroleum gas-, and natural gas-fueled vehicles described in a certification application will be divided into groupings expected to have similar evaporative and/or refueling emission characteristics (as applicable) throughout their useful life. Each group of vehicles with similar evaporative and/or refueling emission characteristics shall be defined as a separate evaporative/refueling family. Manufacturers shall use good

engineering judgment to determine evaporative/refueling families. This section applies for all sizes and types of vehicles that are subject to evaporative or refueling standards, including those subject to standards under 40 CFR 1037.103.

\* \* \* \* \*

(g) Determine evaporative/refueling families separately for vehicles subject to standards under 40 CFR 1037.103 based on the criteria in paragraph (b) of this section, even for vehicles you certify based on engineering analysis under 40 CFR 1037.103(c). In addition, if you certify such vehicles based on testing, include only those vehicle models in the family that are properly represented by that testing, as described in § 86.1828.

- 55. Amend § 86.1823–08 by:
  - a. Revising paragraph (c)(1)(iv)(A).
  - b. Adding paragraph (m) introductory text.
  - c. Revising paragraph (m)(1).
 The addition and revisions read as follows:

**§ 86.1823–08 Durability demonstration procedures for exhaust emissions.**

\* \* \* \* \*

- (c) \* \* \*
- (1) \* \* \*
- (iv) \* \* \*

(A) The simulated test weight will be the equivalent test weight specified in § 86.129 using a weight basis of the loaded vehicle weight for light-duty vehicles and light light-duty trucks, and ALVW for all other vehicles.

\* \* \* \* \*

(m) *Durability demonstration procedures for vehicles subject to the greenhouse gas exhaust emission standards specified in § 86.1818.* Determine a deterioration factor for each exhaust constituent as described in this paragraph (m) and in 40 CFR 600.113–12(h) through (m) to calculate the composite CREE DF value.

(1) CO<sub>2</sub>. (i) Unless otherwise specified under paragraph (m)(1)(ii) or (iii) of this section, manufacturers may use a multiplicative CO<sub>2</sub> deterioration factor of one or an additive deterioration factor of zero to determine full useful life emissions for the FTP and HFET tests.

(ii) Based on an analysis of industry-wide data, EPA may periodically establish and/or update the deterioration factor for CO<sub>2</sub> emissions, including air conditioning and other credit-related emissions. Deterioration factors established and/or updated under this paragraph (m)(1)(ii) will provide adequate lead time for manufacturers to plan for the change.

(iii) For plug-in hybrid electric vehicles and any other vehicle model



the manufacturer determines will experience increased CO<sub>2</sub> emissions over the vehicle's useful life, consistent with good engineering judgment, manufacturers must either install aged batteries and other relevant components on test vehicles as provided in paragraph (f)(2) of this section, determine a deterioration factor based on testing, or provide an engineering analysis that the vehicle is designed such that CO<sub>2</sub> emissions will not increase over the vehicle's useful life. Manufacturers may test using the whole-vehicle mileage accumulation procedures in § 86.1823-08 (c) or (d)(1), or manufacturers may request prior EPA approval for an alternative durability procedure based on good engineering judgment. For the testing option, each FTP test performed on the durability data vehicle selected under § 86.1822 must also be accompanied by an HFET test, and combined FTP/HFET CO<sub>2</sub> results determined by averaging the city (FTP) and highway (HFET) CO<sub>2</sub> values, weighted 0.55 and 0.45 respectively. The deterioration factor will be determined for this combined CO<sub>2</sub> value. Calculated multiplicative deterioration factors that are less than one shall be set to equal one, and calculated additive deterioration factors that are less than zero shall be set to zero.

\* \* \* \* \*

■ 56. Amend § 86.1843-01 by revising paragraph (f)(2) and adding paragraph (i) to read as follows:

**§ 86.1843-01 General information requirements.**

\* \* \* \* \*

(f) \* \* \*

(2) The manufacturer must submit a final update to Part 1 and Part 2 of the Application by May 1 following the end of the model year to incorporate any applicable running changes or corrections which occurred between January 1 of the applicable model year and the end of the model year. A manufacturer may request an extension for submitting the final update. The request must clearly indicate the circumstances necessitating the extension.

\* \* \* \* \*

(i) *Confidential information.* The provisions of 40 CFR 1068.10 and 1068.11 apply for information you submit under this subpart.

■ 57. Amend § 86.1869-12 by revising paragraph (d)(2)(i) to read as follows:

**§ 86.1869-12 CO<sub>2</sub> credits for off-cycle CO<sub>2</sub> reducing technologies.**

\* \* \* \* \*

(d) \* \* \*

(2) \* \* \*

(i) The Administrator will publish a notice of availability in the **Federal Register** notifying the public of a manufacturer's proposed alternative off-cycle credit calculation methodology. The notice will include details regarding the proposed methodology but will not include any Confidential Business Information (see 40 CFR 1068.10 and 1068.11). The notice will include instructions on how to comment on the methodology. The Administrator will take public comments into consideration in the final determination and will notify the public of the final determination. Credits may not be accrued using an approved methodology until the first model year for which the Administrator has issued a final approval.

\* \* \* \* \*

**PART 600—FUEL ECONOMY AND GREENHOUSE GAS EXHAUST EMISSIONS OF MOTOR VEHICLES**

■ 58. The authority citation for part 600 continues to read as follows:

**Authority:** 49 U.S.C. 32901-23919q, Pub. L. 109-58.

■ 59. Amend § 600.001 by removing the paragraph heading from paragraph (e) and adding paragraph (f) to read as follows:

**§ 600.001 General applicability.**

\* \* \* \* \*

(f) Unless we specify otherwise, send all reports and requests for approval to the Designated Compliance Officer (see § 600.002).

■ 60. Amend § 600.002 by adding a definition of "Designated Compliance Officer" in alphabetical order and revising the definitions of "Engine code", "SC03", and "US06" to read as follows:

**§ 600.002 Definitions.**

\* \* \* \* \*

*Designated Compliance Officer* means the Director, Light-Duty Vehicle Center, U.S. Environmental Protection Agency, 2000 Traverwood Drive, Ann Arbor, MI 48105; [complianceinfo@epa.gov](mailto:complianceinfo@epa.gov); [www.epa.gov/ve-certification](http://www.epa.gov/ve-certification).

\* \* \* \* \*

*Engine code* means one of the following:

(1) For LDV, LDT, and MDPV, *engine code* means a unique combination, within a test group (as defined in § 86.1803 of this chapter), of displacement, fuel injection (or carburetion or other fuel delivery system), calibration, distributor

calibration, choke calibration, auxiliary emission control devices, and other engine and emission control system components specified by the Administrator. For electric vehicles, engine code means a unique combination of manufacturer, electric traction motor, motor configuration, motor controller, and energy storage device.

(2) For HDV, *engine code* has the meaning given in § 86.1819-14(d)(12) of this chapter.

\* \* \* \* \*

*SC03* means the test procedure specified in 40 CFR 1066.801(c)(2).

\* \* \* \* \*

*US06* means the test procedure as described in 40 CFR 1066.801(c)(2).

\* \* \* \* \*

- 61. Amend § 600.011 by:
  - a. Adding introductory text;
  - b. Removing paragraph (a);
  - c. Redesignating paragraph (b) as new paragraph (a);
  - d. Adding a new paragraph (b);
  - e. Revising paragraph (c)(2); and
  - f. Removing paragraph (d).

The additions and revisions read as follows:

**§ 600.011 Incorporation by reference.**

Certain material is incorporated by reference into this part with the approval of the Director of the Federal Register under 5 U.S.C. 552(a) and 1 CFR part 51. To enforce any edition other than that specified in this section, EPA must publish a document in the **Federal Register** and the material must be available to the public. All approved incorporation by reference (IBR) material is available for inspection at EPA and at the National Archives and Records Administration (NARA). Contact EPA at: U.S. EPA, Air and Radiation Docket Center, WJC West Building, Room 3334, 1301 Constitution Ave. NW, Washington, DC 20004; [www.epa.gov/dockets](http://www.epa.gov/dockets); (202) 202-1744. For information on inspecting this material at NARA, visit [www.archives.gov/federal-register/cfr/ibr-locations.html](http://www.archives.gov/federal-register/cfr/ibr-locations.html) or email [fr.inspection@nara.gov](mailto:fr.inspection@nara.gov). The material may be obtained from the following sources:

\* \* \* \* \*

(b) International Organization for Standardization, Case Postale 56, CH-1211 Geneva 20, Switzerland; (41) 22749 0111; [central@iso.org](mailto:central@iso.org); or [www.iso.org](http://www.iso.org).

(1) ISO/IEC 18004:2006(E), Information technology—Automatic identification and data capture techniques—QR Code 2005 bar code symbology specification, Second

Edition, September 1, 2006, IBR approved for § 600.302–12(b).

(2) [Reserved]

(c) \* \* \*

(2) SAE J1634 JUL2017, Battery Electric Vehicle Energy Consumption and Range Test Procedure, Revised July 2017; IBR approved for §§ 600.116–12(a); 600.210–12(d); 600.311–12(j) and (k).

\* \* \* \* \*

### Subpart B [Amended]

#### §§ 600.106–08, 600.108–08, 600.109–08, and 600.110–08 [Removed]

■ 62. Remove §§ 600.106–08, 600.108–08, 600.109–08, and 600.110–08.

■ 63. Amend § 600.111–08 by revising the introductory text to read as follows:

#### § 600.111–08 Test procedures.

This section describes test procedures for the FTP, highway fuel economy test (HFET), US06, SC03, and the cold temperature FTP tests. See 40 CFR 1066.801(c) for an overview of these procedures. Perform testing according to test procedures and other requirements contained in this part 600 and in 40 CFR part 1066. This testing includes specifications and procedures for equipment, calibrations, and exhaust sampling. Manufacturers may use data collected according to previously published test procedures for model years through 2021. In addition, we may approve the use of previously published test procedures for later model years as an alternative procedure under 40 CFR 1066.10(c). Manufacturers must comply with regulatory requirements during the transition as described in 40 CFR 86.101 and 86.201.

\* \* \* \* \*

#### § 600.112–08 [Removed]

■ 64. Remove § 600.112–08.

■ 65. Amend § 600.113–12 by revising paragraphs (a)(1), (b) through (d), and (e)(1) to read as follows:

#### § 600.113–12 Fuel economy, CO<sub>2</sub> emissions, and carbon-related exhaust emission calculations for FTP, HFET, US06, SC03 and cold temperature FTP tests.

\* \* \* \* \*

(a) \* \* \*

(1) Calculate the weighted grams/mile values for the FTP test for CO<sub>2</sub>, HC, and CO, and where applicable, CH<sub>3</sub>OH, C<sub>2</sub>H<sub>5</sub>OH, C<sub>2</sub>H<sub>4</sub>O, HCHO, NMHC, N<sub>2</sub>O, and CH<sub>4</sub> as specified in 40 CFR 1066.605. Measure and record the test fuel's properties as specified in paragraph (f) of this section.

\* \* \* \* \*

(b) Calculate the HFET fuel economy as follows:

(1) Calculate the mass values for the highway fuel economy test for HC, CO, and CO<sub>2</sub>, and where applicable, CH<sub>3</sub>OH, C<sub>2</sub>H<sub>5</sub>OH, C<sub>2</sub>H<sub>4</sub>O, HCHO, NMHC, N<sub>2</sub>O, and CH<sub>4</sub> as specified in 40 CFR 1066.605. Measure and record the test fuel's properties as specified in paragraph (f) of this section.

(2) Calculate the grams/mile values for the highway fuel economy test for HC, CO, and CO<sub>2</sub>, and where applicable CH<sub>3</sub>OH, C<sub>2</sub>H<sub>5</sub>OH, C<sub>2</sub>H<sub>4</sub>O, HCHO, NMHC, N<sub>2</sub>O, and CH<sub>4</sub> by dividing the mass values obtained in paragraph (b)(1) of this section, by the actual driving distance, measured in miles, as specified in 40 CFR 1066.840.

(c) Calculate the cold temperature FTP fuel economy as follows:

(1) Calculate the weighted grams/mile values for the cold temperature FTP test for HC, CO, and CO<sub>2</sub>, and where applicable, CH<sub>3</sub>OH, C<sub>2</sub>H<sub>5</sub>OH, C<sub>2</sub>H<sub>4</sub>O, HCHO, NMHC, N<sub>2</sub>O, and CH<sub>4</sub> as specified in 40 CFR 1066.605.

(2) Calculate separately the grams/mile values for the cold transient phase, stabilized phase and hot transient phase of the cold temperature FTP test as specified in 40 CFR 1066.605.

(3) Measure and record the test fuel's properties as specified in paragraph (f) of this section.

(d) Calculate the US06 fuel economy as follows:

(1) Calculate the total grams/mile values for the US06 test for HC, CO, and CO<sub>2</sub>, and where applicable, CH<sub>3</sub>OH, C<sub>2</sub>H<sub>5</sub>OH, C<sub>2</sub>H<sub>4</sub>O, HCHO, NMHC, N<sub>2</sub>O, and CH<sub>4</sub> as specified in 40 CFR 1066.605.

(2) Calculate separately the grams/mile values for HC, CO, and CO<sub>2</sub>, and where applicable, CH<sub>3</sub>OH, C<sub>2</sub>H<sub>5</sub>OH, C<sub>2</sub>H<sub>4</sub>O, HCHO, NMHC, N<sub>2</sub>O, and CH<sub>4</sub>, for both the US06 City phase and the US06 Highway phase of the US06 test as specified in 40 CFR 1066.605 and 1066.831. In lieu of directly measuring the emissions of the separate city and highway phases of the US06 test according to the provisions of 40 CFR 1066.831, the manufacturer may optionally, with the advance approval of the Administrator and using good engineering judgment, analytically determine the grams/mile values for the city and highway phases of the US06 test. To analytically determine US06 City and US06 Highway phase emission results, the manufacturer shall multiply the US06 total grams/mile values determined in paragraph (d)(1) of this section by the estimated proportion of fuel use for the city and highway phases relative to the total US06 fuel use. The manufacturer may estimate the proportion of fuel use for the US06 City and US06 Highway phases by using

modal CO<sub>2</sub>, HC, and CO emissions data, or by using appropriate OBD data (e.g., fuel flow rate in grams of fuel per second), or another method approved by the Administrator.

(3) Measure and record the test fuel's properties as specified in paragraph (f) of this section.

(e) \* \* \*

(1) Calculate the grams/mile values for the SC03 test for HC, CO, and CO<sub>2</sub>, and where applicable, CH<sub>3</sub>OH, C<sub>2</sub>H<sub>5</sub>OH, C<sub>2</sub>H<sub>4</sub>O, HCHO, NMHC, N<sub>2</sub>O, and CH<sub>4</sub> as specified in 40 CFR 1066.605.

\* \* \* \* \*

■ 66. Amend § 600.115–11 by revising the introductory text to read as follows:

#### § 600.115–11 Criteria for determining the fuel economy label calculation method.

This section provides the criteria to determine if the derived 5-cycle method for determining fuel economy label values, as specified in § 600.210–08(a)(2) or (b)(2) or § 600.210–12(a)(2) or (b)(2), as applicable, may be used to determine label values. Separate criteria apply to city and highway fuel economy for each test group. The provisions of this section are optional. If this option is not chosen, or if the criteria provided in this section are not met, fuel economy label values must be determined according to the vehicle-specific 5-cycle method specified in § 600.210–08(a)(1) or (b)(1) or § 600.210–12(a)(1) or (b)(1), as applicable. However, dedicated alternative-fuel vehicles (other than battery electric vehicles and fuel cell vehicles), dual fuel vehicles when operating on the alternative fuel, MDPVs, and vehicles imported by Independent Commercial Importers may use the derived 5-cycle method for determining fuel economy label values whether or not the criteria provided in this section are met. Manufacturers may alternatively account for this effect for battery electric vehicles, fuel cell vehicles, and plug-in hybrid electric vehicles (when operating in the charge-depleting mode) by multiplying 2-cycle fuel economy values by 0.7 and dividing 2-cycle CO<sub>2</sub> emission values by 0.7.

\* \* \* \* \*

■ 67. Amend § 600.116–12 by revising paragraph (a) to read as follows:

#### § 600.116–12 Special procedures related to electric vehicles and hybrid electric vehicles.

(a) Determine fuel economy values for electric vehicles as specified in §§ 600.210 and 600.311 using the procedures of SAE J1634 (incorporated by reference in § 600.011). Use the procedures of SAE J1634, Section 8, with the following clarifications and

modifications for using this and other sections of SAE J1634:

(1) Vehicles that cannot complete the Multi-Cycle Range and Energy Consumption Test (MCT) because they are unable travel the distance required to complete the test with a fully charged battery, or they are unable to achieve the maximum speed on either the UDDS or HFEDS (Highway Fuel Economy Drive Cycle also known as the HFET) cycle should seek Administrator approval to use the procedures outlined in SAE J1634 Section 7 Single Cycle Range and Energy Consumption Test (SCT).

(2) The MCT includes the following key-on soak times and key-off soak periods:

(i) As noted in SAE J1634 Section 8.3.4, a 15 second key-on pause is required between UDDS<sub>1</sub> and HFEDS<sub>1</sub>, and UDDS<sub>3</sub> and HFEDS<sub>2</sub>.

(ii) As noted in SAE J1634 Section 8.3.4, a 10-minute key-off soak period is required between HFEDS<sub>1</sub> and UDDS<sub>2</sub>, and HFEDS<sub>2</sub> and UDDS<sub>4</sub>.

(iii) A key-off soak period up to 30 minutes may be inserted between UDDS<sub>2</sub> and the first phase of the mid-test constant speed cycle, between UDDS<sub>4</sub> and the first phase of the end-of-test constant speed cycle, and between the end of the mid-test constant speed cycle and UDDS<sub>3</sub>. Start the next test segment immediately if there is no key-off soak between test segments.

(iv) If multiple phases are required during either the mid-test constant speed cycle or the end-of-test constant speed cycle there must be a 5-minute to 30-minute key-off soak period between each constant speed phase as noted in SAE J1634 Section 6.6.

(3) As noted in SAE J1634 Section 8.3.4, during all 'key-off' soak periods, the key or power switch must be in the "off" position, the hood must be closed, the test cell fan(s) must be off, and the brake pedal not depressed. For vehicles which do not have a key or power switch the vehicle must be placed in the 'mode' the manufacturer recommends when the vehicle is to be parked and the occupants exit the vehicle.

(4) Manufacturers may determine the mid-test constant speed cycle distance ( $d_M$ ) using their own methodology and good engineering judgment. Otherwise, either Method 1 or Method 2 described in Appendix A of SAE J1634 may be used to estimate the mid-test constant speed cycle distance ( $d_M$ ). The mid-test constant speed cycle distance calculation needs to be performed prior to beginning the test and should not use data from the test being performed. If Method 2 is used, multiply the result determined by the Method 2 equation

by 0.8 to determine the mid-test constant speed cycle distance ( $d_M$ ).

(5) Divide the mid-test constant speed cycle distance ( $d_M$ ) by 65 mph to determine the total time required for the mid-test constant speed cycle. If the time required is one hour or less, the mid-test constant speed cycle can be performed with no key-off soak periods. If the time required is greater than one hour, the mid-test constant speed cycle must be separated into phases such that no phase exceeds more than one hour. At the conclusion of each mid-test constant speed phase, except at the conclusion of the mid-test constant speed cycle, perform a 5-minute to 30-minute key-off soak. A key-off soak period up to 30 minutes may be inserted between the end of the mid-test constant speed cycle and UDDS<sub>3</sub>.

(6) Using good engineering judgment determine the end-of-test constant speed cycle distance so that it does not exceed 20% of the total distance driven during the MCT as described in SAE J1634 Section 8.3.3.

(7) Divide the end-of-test constant speed cycle distance ( $d_E$ ) by 65 mph to determine the total time required for the end-of-test constant speed cycle. If the time required is one-hour or less the end-of-test constant speed cycle can be performed with no key-off soak periods. If the time required is greater than one-hour the end-of-test constant speed cycle must be separated into phases such that no phase exceeds more than one-hour. At the conclusion of each end-of-test constant speed phase, perform a 5-minute to 30-minute key-off soak.

(8) SAE J1634 Section 3.13 defines useable battery energy (UBE) as the total DC discharge energy ( $E_{DC\text{total}}$ ), measured in DC watt-hours for a full discharge test. The total DC discharge energy is the sum of all measured phases of a test inclusive of all drive cycle types. As key-off soak periods are not considered part of the test phase, the discharge energy that occurs during the key-off soak periods is not included in the useable battery energy.

(9) Recharging the vehicle's battery must start within three hours after the end of testing.

(10) At the request of a manufacturer, the Administrator may approve the use of an earlier version of SAE J1634 when a manufacturer is carrying over data for vehicles tested using a prior version of SAE J1634.

(11) All label values related to fuel economy, energy consumption, and range must be based on 5-cycle testing or on values adjusted to be equivalent to 5-cycle results. Prior to performing testing to generate a 5-cycle adjustment

factor, manufacturers must request Administrator approval to use SAE J1634 Appendices B and C for determining a 5-cycle adjustment factor with the following modifications, clarifications, and attestations:

(i) Before model year 2025, prior to performing the 20 °F charge-depleting UDDS, the vehicle must soak for a minimum of 12 hours and a maximum of 36 hours at a temperature of 20 °F. Prior to beginning the 12 to 36 hour cold soak at 20 °F the vehicle must be fully charged, the charging can take place at test laboratory ambient temperatures (68 to 86 °F) or at 20 °F. During the 12 to 36 hour cold soak period the vehicle may not be connected to a charger nor is the vehicle cabin or battery to be preconditioned during the 20 °F soak period.

(ii) Beginning with model year 2025, the 20 °F UDDS charge-depleting UDDS test will be replaced with a 20 °F UDDS test consisting of two UDDS cycles performed with a 10-minute key-off soak between the two UDDS cycles. The data from the two UDDS cycles will be used to calculate the five-cycle adjustment factor, instead of using the results from the entire charge-depleting data set. Manufacturers that have submitted and used the average data from 20 °F charge-depleting UDDS data sets will be required to revise their 5-cycle adjustment factor calculation and re-label vehicles using the data from the first two UDDS cycles only.

Manufacturers, at their discretion, would also be allowed to re-run the 20 °F UDDS test with the battery charged to a state-of-charge (SoC) determined by the manufacturer. The battery does not need to be at 100% SoC before the 20 °F cold soak.

(iii) Manufacturers must submit a written attestation to the Administrator at the completion of testing with the following information:

(A) A statement noting the SoC level of the rechargeable energy storage system (RESS) prior to beginning the 20 °F cold soak for testing performed beginning with model year 2025.

(B) A statement confirming the vehicle was not charged or preconditioned during the 12 to 36 hour 20 °F soak period before starting the 20 °F UDDS cycle.

(C) A summary of all the 5-cycle test results and the calculations used to generate the 5-cycle adjustment factor, including all the 20 °F UDDS cycles, the distance travelled during each UDDS and the measured DC discharge energy during each UDDS phase. Beginning in model year 2025, the 20 °F UDDS test results will consist of only two UDDS cycles.

(D) Beginning in model year 2025, calculate City Fuel Economy using the following equation for *RunningFC*

instead of the equation on Page 30 in Appendix C of SAE J1634:

$$\begin{aligned}
 \text{RunningFC} = & 0.82 \times \left[ \frac{0.48}{\text{Bag2 FTP}} + \frac{0.41}{\text{Bag3 FTP}} + \frac{0.11}{\text{US06 City}} \right] \\
 & + 0.18 \times \left[ \frac{1}{(20\text{degF UDDS1 Bag2} + 20\text{degF UDDS2 Bag2})} + \frac{0.5}{20\text{degF UDDS2 Bag1}} \right] \\
 & + 0.133 \times 1.083 \times \left[ \frac{1}{\text{SC03}} - \left( \frac{0.61}{\text{Bag3 FTP}} + \frac{0.39}{\text{Bag2 FTP}} \right) \right]
 \end{aligned}$$

(E) A description of each test group and configuration which will use the 5-cycle adjustment factor, including the battery capacity of the vehicle used to generate the 5-cycle adjustment factor and the battery capacity of all the configurations to which it will be applied.

(iv) At the conclusion of the manufacturers testing and after receiving the attestations from the manufacturer regarding the performance of the 20 °F UDDS test processes, the 5-cycle test results, and the summary of vehicles to which the manufacturer proposes applying the 5-cycle adjustment factor, the Administrator will review the submittals and inform the manufacturer in writing if the Administrator concurs with the manufacturer’s proposal. If not, the Administrator will describe the rationale to the manufacturer for not approving their request.

\* \* \* \* \*

**Subpart C [Amended]**

■ 68. Amend § 600.210–12 by revising paragraphs (a) introductory text, (a)(2)(iii), and (d) to read as follows:

**§ 600.210–12 Calculation of fuel economy and CO<sub>2</sub> emission values for labeling.**

(a) *General labels.* Except as specified in paragraphs (d) and (e) of this section, fuel economy and CO<sub>2</sub> emissions for general labels may be determined by one of two methods. The first is based on vehicle-specific model-type 5-cycle data as determined in § 600.209–12(b). This method is available for all vehicles and is required for vehicles that do not qualify for the second method as described in § 600.115 (other than electric vehicles). The second method, the derived 5-cycle method, determines fuel economy and CO<sub>2</sub> emissions values from the FTP and HFET tests using equations that are derived from vehicle-specific 5-cycle model type data, as determined in paragraph (a)(2) of this section. Manufacturers may voluntarily lower fuel economy (MPG) values and raise CO<sub>2</sub> values if they determine that

the label values from any method are not representative of the in-use fuel economy and CO<sub>2</sub> emissions for that model type, but only if the manufacturer changes both the MPG values and the CO<sub>2</sub> value and revises any other affected label value accordingly for a model type (including but not limited to the fuel economy 1–10 rating, greenhouse gas 1–10 rating, annual fuel cost, 5-year fuel cost information). Similarly, for any electric vehicles and plug-in hybrid electric vehicles, manufacturers may voluntarily lower the fuel economy (MPGe) and raise the energy consumption (kW-hr/100 mile) values if they determine that the label values are not representative of the in-use fuel economy, energy consumption, and CO<sub>2</sub> emissions for that model type, but only if the manufacturer changes both the MPGe and the energy consumption value and revises any other affected label value accordingly for a model type. Manufacturers may voluntarily lower the value for electric driving range if they determine that the label values are not representative of the in-use electric driving range.

\* \* \* \* \*

(2) \* \* \*

(iii) Unless and until superseded by written guidance from the Administrator, the following intercepts and slopes shall be used in the equations in paragraphs (a)(2)(i) and (ii) of this section:

- City Intercept = 0.004091.
- City Slope = 1.1601.
- Highway Intercept = 0.003191.
- Highway Slope = 1.2945.

\* \* \* \* \*

(d) *Calculating combined fuel economy, CO<sub>2</sub> emissions, and driving range.* (1) If the criteria in § 600.115–11(a) are met for a model type, both the city and highway fuel economy and CO<sub>2</sub> emissions values must be determined using the vehicle-specific 5-cycle method. If the criteria in § 600.115–11(b) are met for a model type, the city fuel economy and CO<sub>2</sub> emissions values may be determined using either method, but the highway fuel economy and CO<sub>2</sub>

emissions values must be determined using the vehicle-specific 5-cycle method (or modified 5-cycle method as allowed under § 600.114–12(b)(2)).

(2) If the criteria in § 600.115 are not met for a model type, the city and highway fuel economy and CO<sub>2</sub> emission label values must be determined by using the same method, either the derived 5-cycle or vehicle-specific 5-cycle.

(3) Manufacturers may use one of the following methods to determine 5-cycle values for fuel economy, CO<sub>2</sub> emissions, and driving range for electric vehicles:

(i) Generate 5-cycle data as described in paragraph (a)(1) of this section using the procedures of SAE J1634 (incorporated by reference in § 600.011) with amendments and revisions as described in § 600.116–12(a).

(ii) Multiply 2-cycle fuel economy values and driving range by 0.7 and divide 2-cycle CO<sub>2</sub> emission values by 0.7.

(iii) Manufacturers may ask the Administrator to approve adjustment factors for deriving 5-cycle fuel economy results from 2-cycle test data based on operating data from their in-use vehicles. Such data should be collected from multiple vehicles with different drivers over a range of representative driving routes and conditions. The Administrator may approve such an adjustment factor for any of the manufacturer’s vehicle models that are properly represented by the collected data.

\* \* \* \* \*

**Subpart D [Amended]**

■ 69. Amend § 600.311–12 by revising paragraphs (j)(2), (j)(4) introductory text, and (j)(4)(i) to read as follows:

**§ 600.311–12 Determination of values for fuel economy labels.**

\* \* \* \* \*

(j) \* \* \*

(2) For electric vehicles, determine the vehicle’s overall driving range as described in Section 8 of SAE J1634 (incorporated by reference in § 600.011),

with amendments and revisions as described in § 600.116. Determine separate range values for FTP-based city and HFET-based highway driving. Adjust these values to represent 5-cycle values as described in § 600.210–12(d)(3), then combine them arithmetically by averaging the two values, weighted 0.55 and 0.45, respectively, and rounding to the nearest whole number.

\* \* \* \* \*

(4) For plug-in hybrid electric vehicles, determine the adjusted charge-depleting (R<sub>cd</sub>) driving range, the adjusted all electric driving range (if applicable), and overall adjusted driving range as described in SAE J1711 (incorporated by reference in § 600.011), as described in § 600.116, as follows:

(i) Determine the vehicle's Actual Charge-Depleting Range, R<sub>cd</sub>, separately for FTP-based city and HFET-based highway driving. Adjust these values to represent 5-cycle values as described in 600.115–11, then combine them arithmetically by averaging the two values, weighted 0.55 and 0.45, respectively, and rounding to the nearest whole number. Precondition the vehicle as needed to minimize engine operation for consuming stored fuel vapors in evaporative canisters; for example, you may purge the evaporative canister or time a refueling event to avoid engine starting related to purging the canister. For vehicles that use combined power from the battery and the engine before the battery is fully discharged, also use this procedure to establish an all electric range by determining the distance the vehicle drives before the engine starts, rounded to the nearest mile. You may represent this as a range of values. We may approve adjustments to these procedures if they are necessary to properly characterize a vehicle's all electric range.

\* \* \* \* \*

**Subpart F [Amended]**

■ 70. Amend § 600.510–12 by revising the entry defining the term “AFE” under the formula in paragraph (e) to read as follows:

**§ 600.510–12 Calculation of average fuel economy and average carbon-related exhaust emissions.**

\* \* \* \* \*

(e) \* \* \*

AFE = Average combined fuel economy as calculated in paragraph (c)(2) of this section, rounded to the nearest 0.0001 mpg;

\* \* \* \* \*

■ 71. Amend § 600.512–12 by adding paragraph (a)(3) and revising paragraph (b) to read as follows:

**§ 600.512–12 Model year report.**

(a) \* \* \*

(3) Separate reports shall be submitted for passenger automobiles and light trucks (as identified in § 600.510–12).

(b) The model year report shall be in writing, signed by the authorized representative of the manufacturer and shall be submitted no later than May 1 following the end of the model year. A manufacturer may request an extension for submitting the model year report if that is needed to provide all additional required data as determined in § 600.507–12. The request must clearly indicate the circumstances necessitating the extension.

\* \* \* \* \*

**PART 1027—FEES FOR VEHICLE AND ENGINE COMPLIANCE PROGRAMS**

■ 72. The authority citation for part 1027 continues to read as follows:

Authority: 42 U.S.C. 7401–7671q.

■ 73. Amend § 1027.101 by revising paragraph (a)(1) to read as follows:

**§ 1027.101 To whom do these requirements apply?**

(a) \* \* \*

(1) Motor vehicles and motor vehicle engines we regulate under 40 CFR part 86 or 1036. This includes light-duty vehicles, light-duty trucks, medium-duty passenger vehicles, highway motorcycles, and heavy-duty highway engines and vehicles.

\* \* \* \* \*

**PART 1030—CONTROL OF GREENHOUSE GAS EMISSIONS FROM ENGINES INSTALLED ON AIRPLANES**

■ 74. The authority citation for part 1030 continues to read as follows:

Authority: 42 U.S.C. 7401–7671q.

■ 75. Revise § 1030.98 to read as follows:

**§ 1030.98 Confidential information.**

The provisions of 40 CFR 1068.10 and 1068.11 apply for information you submit under this part.

**PART 1031—CONTROL OF AIR POLLUTION FROM AIRCRAFT ENGINES**

■ 76. The authority citation for part 1031 continues to read as follows:

Authority: 42 U.S.C. 7401–7671q.

**Subpart C [Amended]**

■ 77. Revise § 1031.170 to read as follows:

**§ 1031.170 Confidential information.**

The provisions of 40 CFR 1068.10 and 1068.11 apply for information you submit under this part.

**PART 1033—CONTROL OF EMISSIONS FROM LOCOMOTIVES**

■ 78. The authority citation for part 1033 continues to read as follows:

Authority: 42 U.S.C. 7401–7671q.

**Subpart A [Amended]**

■ 79. Amend § 1033.1 by revising paragraph (e) to read as follows:

**§ 1033.1 Applicability.**

\* \* \* \* \*

(e) This part applies for locomotives that were certified as freshly manufactured or remanufactured locomotives under 40 CFR part 92.

**§ 1033.5 [Amended]**

■ 80. Amend § 1033.5 by removing and reserving paragraph (c).

**Subpart B [Amended]**

■ 81. Amend § 1033.101 by revising the introductory text to read as follows:

**§ 1033.101 Exhaust emission standards.**

See appendix A of this part to determine how emission standards apply before 2023.

\* \* \* \* \*

**§ 1033.102 [Removed]**

■ 82. Remove § 1033.102.

■ 83. Amend § 1033.115 by revising paragraphs (b) introductory text and (c) to read as follows:

**§ 1033.115 Other requirements.**

\* \* \* \* \*

(b) *Adjustable parameters.* Locomotives that have adjustable parameters must meet all the requirements of this part for any adjustment in the approved adjustable range. General provisions for adjustable parameters apply as specified in 40 CFR 1068.50. You must specify in your application for certification the adjustable range of each adjustable parameter on a new locomotive or new locomotive engine to—

\* \* \* \* \*

(c) *Prohibited controls.* (1) *General provisions.* You may not design or produce your locomotives with emission control devices, systems, or elements of design that cause or

contribute to an unreasonable risk to public health, welfare, or safety while operating. For example, a locomotive may not emit a noxious or toxic substance it would otherwise not emit that contributes to such an unreasonable risk.

(2) *Vanadium sublimation in SCR catalysts.* For engines equipped with vanadium-based SCR catalysts, you must design the engine and its emission controls to prevent vanadium sublimation and protect the catalyst from high temperatures. We will evaluate your engine design based on the following information that you must include in your application for certification:

(i) Identify the threshold temperature for vanadium sublimation for your specified SCR catalyst formulation as described in 40 CFR 1065.1113 through 1065.1121.

(ii) Describe how you designed your engine to prevent catalyst inlet temperatures from exceeding the temperature you identify in paragraph (c)(2)(i) of this section, including consideration of engine wear through the useful life. Also describe your design for catalyst protection in case catalyst temperatures exceed the specified temperature. In your description, include how you considered elevated catalyst temperature resulting from sustained high-load engine operation, catalyst exotherms, particulate filter regeneration, and component failure resulting in unburned fuel in the exhaust stream.

\* \* \* \* \*

■ 84. Amend § 1033.120 by revising paragraph (c) to read as follows:

**§ 1033.120 Emission-related warranty requirements.**

\* \* \* \* \*

(c) *Components covered.* The emission-related warranty covers all components whose failure would increase a locomotive's emissions of any regulated pollutant. This includes components listed in 40 CFR part 1068, appendix A, and components from any other system you develop to control emissions. The emission-related warranty covers the components you sell even if another company produces the component. Your emission-related warranty does not need to cover components whose failure would not increase a locomotive's emissions of any regulated pollutant. For remanufactured locomotives, your emission-related warranty is required to cover only those parts that you supply or those parts for which you specify allowable part manufacturers. It does not need to cover

used parts that are not replaced during the remanufacture.

\* \* \* \* \*

**Subpart C [Amended]**

■ 85. Amend § 1033.205 by revising paragraph (d)(6) to read as follows:

**§ 1033.205 Applying for a certificate of conformity.**

\* \* \* \* \*

(d) \* \* \*

(6) A description of injection timing, fuel rate, and all other adjustable operating parameters, including production tolerances. For any operating parameters that do not qualify as adjustable parameters, include a description supporting your conclusion (see 40 CFR 1068.50(c)). Include the following in your description of each adjustable parameter:

(i) For practically adjustable operating parameters, include the nominal or recommended setting, the intended practically adjustable range, the limits or stops used to limit adjustable ranges, and production tolerances of the limits or stops used to establish each practically adjustable range. State that the physical limits, stops or other means of limiting adjustment, are effective in preventing adjustment of parameters on in-use engines to settings outside your intended practically adjustable ranges and provide information to support this statement.

(ii) For programmable operating parameters, state that you have restricted access to electronic controls to prevent parameter adjustments on in-use engines that would allow operation outside the practically adjustable range. Describe how your engines are designed to prevent unauthorized adjustments.

\* \* \* \* \*

■ 86. Amend § 1033.245 by adding paragraph (f) to read as follows:

**§ 1033.245 Deterioration factors.**

\* \* \* \* \*

(f) You may alternatively determine and verify deterioration factors based on bench-aged aftertreatment as described in 40 CFR 1036.245 and 1036.246, with the following exceptions:

(1) The minimum required aging for locomotive engines as specified in 40 CFR 1036.245(c)(2) is 3,000 hours. Operate the engine for service accumulation using the same sequence of duty cycles that would apply for determining a deterioration factor under paragraphs (a) through (d) of this section.

(2) Perform verification testing as described in subpart F of this part rather than 40 CFR 1036.555. The provisions

of 40 CFR 1036.246(d)(2) do not apply. Perform testing consistent with the original certification to determine whether tested locomotives meet the duty-cycle emission standards in § 1033.101.

(3) Apply infrequent regeneration adjustment factors as specified in § 1033.535 rather than 40 CFR 1036.580.

**Subpart F [Amended]**

■ 87. Revise § 1033.525 to read as follows:

**§ 1033.525 Smoke opacity testing.**

Analyze exhaust opacity test data as follows:

(a) Measure exhaust opacity using the procedures specified in 40 CFR 1065.1125. Perform the opacity test with a continuous digital recording of smokemeter response identified by notch setting over the entire locomotive test cycle specified in § 1033.515(c)(4) or § 1033.520(e)(4). Measure smokemeter response in percent opacity to within one percent resolution.

(b) Calibrate the smokemeter as follows:

(1) Calibrate using neutral density filters with approximately 10, 20, and 40 percent opacity. Confirm that the opacity values for each of these reference filters are NIST-traceable within 185 days of testing, or within 370 days of testing if you consistently protect the reference filters from light exposure between tests.

(2) Before each test, remove the smokemeter from the exhaust stream, if applicable, and calibrate as follows:

(i) *Zero.* Adjust the smokemeter to give a zero response when there is no detectable smoke.

(ii) *Linearity.* Insert each of the qualified reference filters in the light path perpendicular to the axis of the light beam and adjust the smokemeter to give a result within 1 percentage point of the named value for each reference filter.

(c) Use computer analysis to evaluate percent opacity for each notch setting. Treat the start of the first idle mode as the start of the test. Each mode ends when operator demand changes for the next mode (or for the end of the test). Analyze the opacity trace using the following procedure:

(1) *3 second peak.* Identify the highest opacity value over the test and integrate the highest 3 second average including that highest value.

(2) *30 second peak.* Divide the test into a series of 30 second segments, advancing each segment in 1 second increments. Determine the opacity value for each segment and identify the

highest opacity value from all the 30 second segments.

(3) *Steady-state*. Calculate the average of second-by-second values between 120 and 180 seconds after the start of each

mode. For RMC modes that are less than 180 seconds, calculate the average over the last 60 seconds of the mode. Identify the highest of those steady-state values from the different modes.

(d) Determine values of standardized percent opacity,  $\kappa_{std}$ , by correcting to a reference optical path length of 1 meter for comparing to the standards using the following equation:

$$\kappa_{std} = 100 \cdot \left( 1 - \left( 1 - \frac{\kappa_{meas}}{100} \right)^{\frac{1}{l_{meas}}} \right)$$

Eq. 1033.525-1

Where:

$\kappa_{meas}$  = the value of percent opacity from paragraphs (c)(1) through (3) of this section.

$l_{meas}$  = the smokemeter's optical path length in the exhaust plume, expressed to the nearest 0.01 meters.

*Example:*

$\kappa_{meas} = 14.1\%$   
 $l_{meas} = 1.11 \text{ m}$

$$\kappa_{std} = 100 \cdot \left( 1 - \left( 1 - \frac{14.1}{100} \right)^{\frac{1}{1.11}} \right)$$

$\kappa_{std} = 12.8\%$

**Subpart G [Amended]**

■ 88. Amend § 1033.630 by revising paragraph (b)(1) to read as follows:

**§ 1033.630 Staged-assembly and delegated assembly exemptions.**

\* \* \* \* \*

(b) \* \* \*

(1) In cases where an engine has been assembled in its certified configuration, properly labeled, and will not require an aftertreatment device to be attached when installed in the locomotive, no exemption is needed to ship the engine. You do not need an exemption to ship engines without specific components if they are not emission-related components identified in appendix A of 40 CFR part 1068.

\* \* \* \* \*

■ 89. Amend § 1033.815 by revising paragraph (f) to read as follows:

**§ 1033.815 Maintenance, operation, and repair.**

\* \* \* \* \*

(f) Failure to perform required maintenance is a violation of the tampering prohibition in 40 CFR 1068.101(b)(1). Failure of any person to comply with the recordkeeping requirements of this section is a violation of 40 CFR 1068.101(a)(2).

**Subpart J [Amended]**

■ 90. Amend § 1033.901 by revising the definitions of “Adjustable parameter” and “Designated Compliance Officer” to read as follows:

**§ 1033.901 Definitions.**

\* \* \* \* \*

*Adjustable parameter* has the meaning given in 40 CFR 1068.50.

\* \* \* \* \*

*Designated Compliance Officer* means the Director, Diesel Engine Compliance Center, U.S. Environmental Protection Agency, 2000 Traverwood Drive, Ann Arbor, MI 48105; *complianceinfo@epa.gov*; *www.epa.gov/ve-certification*.

\* \* \* \* \*

■ 91. Redesignate appendix I to part 1033 as appendix A to part 1033 and

revise newly redesignated appendix A to read as follows:

**Appendix A to Part 1033—Original Standards for Tier 0, Tier 1 and Tier 2 Locomotives**

(a) Locomotives were originally subject to Tier 0, Tier 1, and Tier 2 emission standards described in paragraph (b) of this appendix as follows:

(1) The Tier 0 and Tier 1 standards in paragraph (b) of this appendix applied instead of the Tier 0 and Tier 1 standards of § 1033.101 for locomotives manufactured and remanufactured before January 1, 2010. For example, a locomotive that was originally manufactured in 2004 and remanufactured on April 10, 2011, was subject to the original Tier 1 standards specified in paragraph (b) of this appendix and became subject to the Tier 1 standards of § 1033.101 when it was remanufactured on April 10, 2011.

(2) The Tier 2 standards in paragraph (b) of this appendix applied instead of the Tier 2 standards of § 1033.101 for locomotives manufactured and remanufactured before January 1, 2013.

(b) The following NO<sub>x</sub> and PM standards applied before the dates specified in paragraph (a) of this appendix:

TABLE 1 TO APPENDIX A—ORIGINAL LOCOMOTIVE EMISSION STANDARDS

Type of standard	Year of original manufacture	Tier	Standards (g/bhp-hr)		
			NO <sub>x</sub>	PM-primary	PM-alternate <sup>a</sup>
Line-haul .....	1973–1992	Tier 0	9.5	0.60	0.30
	1993–2004	Tier 1	7.4	0.45	0.22
	2005–2011	Tier 2	5.5	0.20	0.10
Switch .....	1973–1992	Tier 0	14.0	0.72	0.36
	1993–2004	Tier 1	11.0	0.54	0.27

TABLE 1 TO APPENDIX A—ORIGINAL LOCOMOTIVE EMISSION STANDARDS—Continued

Type of standard	Year of original manufacture	Tier	Standards (g/bhp-hr)		
			NO <sub>x</sub>	PM-primary	PM-alternate <sup>a</sup>
	2005–2011	Tier 2	8.1	0.24	0.12

<sup>a</sup> Locomotives certified to the alternate PM standards are also subject to alternate CO standards of 10.0 for the line-haul cycle and 12.0 for the switch cycle.

(c) The original Tier 0, Tier 1, and Tier 2 standards for HC and CO emissions and smoke are the same standards identified in § 1033.101.

■ 92. Revise part 1036 to read as follows:

**PART 1036—CONTROL OF EMISSIONS FROM NEW AND IN-USE HEAVY-DUTY HIGHWAY ENGINES**

**Subpart A—Overview and Applicability**

Sec.

- 1036.1 Applicability.
- 1036.2 Compliance responsibility.
- 1036.5 Excluded engines.
- 1036.10 Organization of this part.
- 1036.15 Other applicable regulations.
- 1036.30 Submission of information.

**Subpart B—Emission Standards and Related Requirements**

- 1036.101 Overview of exhaust emission standards.
- 1036.104 Criteria pollutant emission standards—NO<sub>x</sub>, HC, PM, and CO.
- 1036.108 Greenhouse gas emission standards—CO<sub>2</sub>, CH<sub>4</sub>, and N<sub>2</sub>O.
- 1036.110 Diagnostic controls.
- 1036.111 Inducements related to SCR.
- 1036.115 Other requirements.
- 1036.120 Emission-related warranty requirements.
- 1036.125 Maintenance instructions and allowable maintenance.
- 1036.130 Installation instructions for vehicle manufacturers.
- 1036.135 Labeling.
- 1036.136 Clean Idle sticker.
- 1036.140 Primary intended service class and engine cycle.
- 1036.150 Interim provisions.

**Subpart C—Certifying Engine Families**

- 1036.201 General requirements for obtaining a certificate of conformity.
- 1036.205 Requirements for an application for certification.
- 1036.210 Preliminary approval before certification.
- 1036.225 Amending applications for certification.
- 1036.230 Selecting engine families.
- 1036.235 Testing requirements for certification.
- 1036.240 Demonstrating compliance with criteria pollutant emission standards.
- 1036.241 Demonstrating compliance with greenhouse gas emission standards.
- 1036.245 Deterioration factors for exhaust emission standards.
- 1036.246 Verifying deterioration factors.

- 1036.250 Reporting and recordkeeping for certification.
- 1036.255 EPA oversight on certificates of conformity.

**Subpart D—Testing Production Engines and Hybrid Powertrains**

- 1036.301 Measurements related to GEM inputs in a selective enforcement audit.

**Subpart E—In-use Testing**

- 1036.401 Testing requirements for in-use engines.
- 1036.405 Overview of the manufacturer-run field-testing program.
- 1036.410 Selecting and screening vehicles and engines for testing.
- 1036.415 Preparing and testing engines.
- 1036.420 Pass criteria for individual engines.
- 1036.425 Pass criteria for engine families.
- 1036.430 Reporting requirements.
- 1036.435 Recordkeeping requirements.
- 1036.440 Warranty obligations related to in-use testing.

**Subpart F—Test Procedures**

- 1036.501 General testing provisions.
- 1036.505 Engine data and information to support vehicle certification.
- 1036.510 Supplemental Emission Test.
- 1036.512 Federal Test Procedure.
- 1036.514 Low Load Cycle.
- 1036.520 Determining power and vehicle speed values for powertrain testing.
- 1036.525 Clean Idle test.
- 1036.530 Test procedures for off-cycle testing.
- 1036.535 Determining steady-state engine fuel maps and fuel consumption at idle.
- 1036.540 Determining cycle-average engine fuel maps.
- 1036.543 Carbon balance error verification.
- 1036.550 Calculating greenhouse gas emission rates.
- 1036.555 Test procedures to verify deterioration factors.
- 1036.580 Infrequently regenerating aftertreatment devices.

**Subpart G—Special Compliance Provisions**

- 1036.601 Overview of compliance provisions.
- 1036.605 Alternate emission standards for engines used in specialty vehicles.
- 1036.610 Off-cycle technology credits and adjustments for reducing greenhouse gas emissions.
- 1036.615 Engines with Rankine cycle waste heat recovery and hybrid powertrains.
- 1036.620 Alternate CO<sub>2</sub> standards based on model year 2011 compression-ignition engines.
- 1036.625 In-use compliance with CO<sub>2</sub> family emission limits (FELs).

- 1036.630 Certification of engine greenhouse gas emissions for powertrain testing.
- 1036.655 Special provisions for diesel-fueled engines sold in American Samoa or the Commonwealth of the Northern Mariana Islands.

**Subpart H—Averaging, Banking, and Trading for Certification**

- 1036.701 General provisions.
- 1036.705 Generating and calculating emission credits.
- 1036.710 Averaging.
- 1036.715 Banking.
- 1036.720 Trading.
- 1036.725 Required information for certification.
- 1036.730 ABT reports.
- 1036.735 Recordkeeping.
- 1036.740 Restrictions for using emission credits.
- 1036.745 End-of-year CO<sub>2</sub> credit deficits.
- 1036.750 Consequences for noncompliance.
- 1036.755 Information provided to the Department of Transportation.

**Subpart I—Definitions and Other Reference Information**

- 1036.801 Definitions.
- 1036.805 Symbols, abbreviations, and acronyms.
- 1036.810 Incorporation by reference.
- 1036.815 Confidential information.
- 1036.820 Requesting a hearing.
- 1036.825 Reporting and recordkeeping requirements.
- Appendix A of Part 1036—Summary of Previous Emission Standards
- Appendix B of Part 1036—Transient Duty Cycles
- Appendix C of Part 1036—Default Engine Fuel Maps for § 1036.540

Authority: 42 U.S.C. 7401—7671q.

**Subpart A—Overview and Applicability**

**§ 1036.1 Applicability.**

(a) Except as specified in § 1036.5, the provisions of this part apply for engines that will be installed in heavy-duty vehicles (including glider vehicles). Heavy-duty engines produced before December 20, 2026 are subject to greenhouse gas emission standards and related provisions under this part as specified in § 1036.108; these engines are subject to exhaust emission standards for NO<sub>x</sub>, HC, PM, and CO, and related provisions under 40 CFR part 86, subpart A and subpart N, instead of this part, except as follows:



(1) The provisions of §§ 1036.115, 1036.501(d), and 1036.601 apply.

(2) 40 CFR parts 85 and 86 may specify that certain provisions in this part apply.

(3) This part describes how several individual provisions are optional or mandatory before model year 2027. For example, § 1036.150(a) describes how you may generate emission credits by meeting the standards of this part before model year 2027.

(b) The provisions of this part also apply for fuel conversions of all engines described in paragraph (a) of this section as described in 40 CFR 85.502.

(c) Gas turbine heavy-duty engines and other heavy-duty engines not meeting the definition of *compression-ignition* or *spark-ignition* are deemed to be compression-ignition engines for purposes of this part.

(d) For the purpose of applying the provisions of this part, engines include all emission-related components and any components or systems that should be identified in your application for certification, such as hybrid components for engines that are certified as hybrid engines or hybrid powertrains.

#### § 1036.2 Compliance responsibility.

The regulations in this part contain provisions that affect both engine manufacturers and others. However, the requirements of this part are generally addressed to the engine manufacturer(s). The term “you” generally means the engine manufacturer(s), especially for issues related to certification. Additional requirements and prohibitions apply to other persons as specified in subpart G of this part and 40 CFR part 1068.

#### § 1036.5 Excluded engines.

(a) The provisions of this part do not apply to engines used in medium-duty passenger vehicles or other heavy-duty vehicles that are subject to regulation under 40 CFR part 86, subpart S, except as specified in 40 CFR part 86, subpart S, and § 1036.150(j). For example, this exclusion applies for engines used in vehicles certified to the standards of 40 CFR 86.1818 and 86.1819.

(b) An engine installed in a heavy-duty vehicle that is not used to propel the vehicle is not a heavy-duty engine. The provisions of this part therefore do not apply to these engines. Note that engines used to indirectly propel the vehicle (such as electrical generator engines that provide power to batteries for propulsion) are subject to this part. See 40 CFR part 1039, 1048, or 1054 for other requirements that apply for these auxiliary engines. See 40 CFR part 1037

for requirements that may apply for vehicles using these engines, such as the evaporative and refueling emission requirements of 40 CFR 1037.103.

(c) The provisions of this part do not apply to aircraft or aircraft engines. Standards apply separately to certain aircraft engines, as described in 40 CFR part 87.

(d) The provisions of this part do not apply to engines that are not internal combustion engines. For example, the provisions of this part generally do not apply to fuel cells. Note that gas turbine engines are internal combustion engines.

(e) The provisions of this part do not apply for model year 2013 and earlier heavy-duty engines unless they were:

(1) Voluntarily certified to this part.

(2) Installed in a glider vehicle subject to 40 CFR part 1037.

#### § 1036.10 Organization of this part.

This part is divided into the following subparts:

(a) Subpart A of this part defines the applicability of this part and gives an overview of regulatory requirements.

(b) Subpart B of this part describes the emission standards and other requirements that must be met to certify engines under this part. Note that § 1036.150 describes certain interim requirements and compliance provisions that apply only for a limited time.

(c) Subpart C of this part describes how to apply for a certificate of conformity.

(d) Subpart D of this part addresses testing of production engines.

(e) Subpart E of this part describes provisions for testing in-use engines.

(f) Subpart F of this part describes how to test your engines (including references to other parts of the Code of Federal Regulations).

(g) Subpart G of this part describes requirements, prohibitions, and other provisions that apply to engine manufacturers, vehicle manufacturers, owners, operators, rebuilders, and all others.

(h) Subpart H of this part describes how you may generate and use emission credits to certify your engines.

(i) Subpart I of this part contains definitions and other reference information.

#### § 1036.15 Other applicable regulations.

(a) Parts 85 and 86 of this chapter describe additional provisions that apply to engines that are subject to this part. See § 1036.601.

(b) Part 1037 of this chapter describes requirements for controlling evaporative and refueling emissions and greenhouse

gas emissions from heavy-duty vehicles, whether or not they use engines certified under this part.

(c) Part 1065 of this chapter describes procedures and equipment specifications for testing engines to measure exhaust emissions. Subpart F of this part describes how to apply the provisions of part 1065 of this chapter to determine whether engines meet the exhaust emission standards in this part.

(d) The requirements and prohibitions of part 1068 of this chapter apply as specified in § 1036.601 to everyone, including anyone who manufactures, imports, installs, owns, operates, or rebuilds any of the engines subject to this part, or vehicles containing these engines. See § 1036.601 to determine how to apply the part 1068 regulations for heavy-duty engines. The issues addressed by these provisions include these seven areas:

(1) Prohibited acts and penalties for engine manufacturers, vehicle manufacturers, and others.

(2) Rebuilding and other aftermarket changes.

(3) Exclusions and exemptions for certain engines.

(4) Importing engines.

(5) Selective enforcement audits of your production.

(6) Recall.

(7) Procedures for hearings.

(e) Other parts of this chapter apply if referenced in this part.

#### § 1036.30 Submission of information.

Unless we specify otherwise, send all reports and requests for approval to the Designated Compliance Officer (see § 1036.801). See § 1036.825 for additional reporting and recordkeeping provisions.

#### Subpart B—Emission Standards and Related Requirements

##### § 1036.101 Overview of exhaust emission standards.

(a) You must show that engines meet the following exhaust emission standards:

(1) Criteria pollutant standards for NO<sub>x</sub>, HC, PM, and CO apply as described in § 1036.104.

(2) Greenhouse gas (GHG) standards for CO<sub>2</sub>, CH<sub>4</sub>, and N<sub>2</sub>O apply as described in § 1036.108.

(b) You may optionally demonstrate compliance with the emission standards of this part by testing hybrid engines and hybrid powertrains, rather than testing the engine alone. Except as specified, provisions of this part that reference engines apply equally to hybrid engines and hybrid powertrains.

**§ 1036.104 Criteria pollutant emission standards—NO<sub>x</sub>, HC, PM, and CO.**

This section describes the applicable NO<sub>x</sub>, HC, CO, and PM standards for model years 2027 and later. These standards apply equally for all primary

intended service classes unless otherwise noted.

(a) *Emission standards.* Exhaust emissions may not exceed the standards in this section, as follows:

(1) The following emission standards apply for Light HDE, Medium HDE, and Heavy HDE over the FTP, SET, and LLC duty cycles using the test procedures described in subpart F of this part:

TABLE 1 TO PARAGRAPH (a)(1) OF § 1036.104—COMPRESSION-IGNITION STANDARDS FOR DUTY CYCLE TESTING

Duty cycle	NO <sub>x</sub> mg/hp-hr	HC mg/hp-hr	PM mg/hp-hr	CO g/hp-hr
SET and FTP .....	35	60	5	6.0
LLC .....	50	140	5	6.0

(2) The following emission standards apply for Spark-ignition HDE over the FTP and SET duty cycles using the test

procedures described in subpart F of this part:

TABLE 2 TO PARAGRAPH (a)(2) OF § 1036.104—SPARK-IGNITION STANDARDS FOR DUTY CYCLE TESTING

Duty cycle	NO <sub>x</sub> mg/hp-hr	HC mg/hp-hr	PM mg/hp-hr	CO g/hp-hr
SET .....	35	60	5	14.4
FTP .....	35	60	5	6.0

(3) The following off-cycle emission standards apply for Light HDE, Medium HDE, and Heavy HDE using the

procedures specified in § 1036.530, as follows:

TABLE 3 TO PARAGRAPH (a)(3) OF § 1036.104—COMPRESSION-IGNITION STANDARDS FOR OFF-CYCLE TESTING

Off-cycle Bin	NO <sub>x</sub>	Temperature adjustment <sup>a</sup>	HC mg/hp-hr	PM mg/hp-hr	CO g/hp-hr
Bin 1 .....	10.0 g/hr .....	$(25.0 - \bar{T}_{amb}) \cdot 0.25$ .....	.....	.....	.....
Bin 2 .....	58 mg/hp-hr .....	$(25.0 - \bar{T}_{amb}) \cdot 2.2$ .....	120	7.5	9

<sup>a</sup>  $\bar{T}_{amb}$  is the mean ambient temperature over a shift-day, or equivalent. Adjust the off-cycle NO<sub>x</sub> standard for  $\bar{T}_{amb}$  below 25.0 °C by adding the calculated temperature adjustment to the specified NO<sub>x</sub> standard. Round the temperature adjustment to the same precision as the NO<sub>x</sub> standard for the appropriate bin. If you declare a NO<sub>x</sub> FEL for the engine family, do not apply the FEL scaling calculation from paragraph (c)(3) of this section to the calculated temperature adjustment.

(b) *Clean Idle.* You may optionally certify compression-ignition engines to the Clean Idle NO<sub>x</sub> emission standard using the Clean Idle test specified in § 1036.525. The optional Clean Idle NO<sub>x</sub> emission standard is 30.0 g/h for model years 2024 through 2026, and 10.0 g/hr for model year 2027 and later. The standard applies separately to each mode of the Clean Idle test. If you certify an engine family to the Clean Idle standards, it is subject to all these voluntary standards as if they were mandatory.

(c) *Averaging, banking, and trading.* You may generate or use emission credits under the averaging, banking,

and trading (ABT) program described in subpart H of this part for demonstrating compliance with NO<sub>x</sub> emission standards in paragraph (a) of this section. You must meet the PM, HC, and CO emission standards in § 1036.104(a) without generating or using emission credits.

(1) To generate or use emission credits, you must specify a family emission limit for each engine family. Declare the family emission limit corresponding to full useful life for engine operation over the FTP duty cycle, FEL<sub>FTP</sub>, expressed to the same number of decimal places as the emission standard. Use FEL<sub>FTP</sub> to

calculate emission credits in subpart H of this part.

(2) The following NO<sub>x</sub> FEL caps are the maximum value you may specify for FEL<sub>FTP</sub>:

- (i) 65 mg/hp-hr for model years 2027 through 2030.
- (ii) 50 mg/hp-hr for model year 2031 and later.
- (iii) 70 mg/hp-hr for model year 2031 and later Heavy HDE.

(3) Calculate the NO<sub>x</sub> family emission limit, FEL<sub>[cycle]NO<sub>x</sub></sub>, that applies for each duty-cycle or off-cycle standard using the following equation:

$$FEL_{[cycle]NO_x} = Std_{[cycle]NO_x} \cdot \frac{FEL_{FTPNO_x}}{Std_{FTPNO_x}}$$

Eq. 1036.104-1

Where:

Std<sub>[cycle]NO<sub>x</sub></sub> = the NO<sub>x</sub> emission standard that applies for the applicable cycle or

for off-cycle testing under paragraph (a)

of this section for engines not participating in the ABT program.  
*FEL<sub>FTPNOx</sub>* = the engine family's declared FEL for NO<sub>x</sub> over the FTP duty cycle from paragraph (c)(1) of this section.

*Std<sub>FTPNOx</sub>* = the NO<sub>x</sub> emission standard that applies for the FTP duty cycle under paragraph (a) of this section for engines not participating in the ABT program.

*Example for model year 2029 Medium HDE for the SET:*

*Std<sub>SETNOx</sub>* = 35 mg/hp-hr  
*FEL<sub>FTP</sub>* = 121 mg/hp-hr  
*Std<sub>FTPNOx</sub>* = 35 mg/hp-hr

$$FEL_{SETNOx} = 35 \cdot \frac{121}{35} = 121 \text{ mg/hp} \cdot \text{hr}$$

*FEL<sub>SETNOx</sub>* = 121 mg/hp-hr

(4) The family emission limits you select under this paragraph (c) serve as the emission standards for compliance testing instead of the standards specified in this section.

(d) *Fuel types.* The exhaust emission standards in this section apply for engines using the fuel type on which the

engines in the engine family are designed to operate. You must meet the numerical emission standards for HC in this section based on the following types of hydrocarbon emissions for engines powered by the following fuels:

- (1) Alcohol-fueled engines: NMHCE emissions.

(2) Gaseous-fueled engines: NMNEHC emissions.

(3) Other engines: NMHC emissions.

(e) *Useful life.* The exhaust emission standards of this section apply for the useful life, expressed in vehicle miles, or hours of engine operation, or years in service, whichever comes first, as follows:

TABLE 4 TO PARAGRAPH (e) OF § 1036.104—USEFUL LIFE BY PRIMARY INTENDED SERVICE CLASS

Primary intended service class	Model year 2026 and earlier			Model year 2027 and later		
	Miles	Years	Hours	Miles	Years	Hours
Spark-ignition HDE .....	110,000	10	.....	200,000	15	10,000
Light HDE .....	110,000	10	.....	270,000	15	13,000
Medium HDE .....	185,000	10	.....	350,000	12	17,000
Heavy HDE .....	435,000	10	22,000	650,000	11	32,000

(f) *Applicability for testing.* The emission standards in this subpart apply to all testing, including certification, selective enforcement audits, and in-use testing. For selective enforcement audits, we may require you to perform the appropriate duty-cycle testing as specified in §§ 1036.510, 1036.512, and 1036.514. We may direct you to do additional testing to show that your engines meet the off-cycle standards.

**§ 1036.108 Greenhouse gas emission standards—CO<sub>2</sub>, CH<sub>4</sub>, and N<sub>2</sub>O.**

This section contains standards and other regulations applicable to the emission of the air pollutant defined as the aggregate group of six greenhouse gases: carbon dioxide, nitrous oxide, methane, hydrofluorocarbons, perfluorocarbons, and sulfur hexafluoride. This section describes the applicable CO<sub>2</sub>, N<sub>2</sub>O, and CH<sub>4</sub> standards for engines.

(a) *Emission standards.* Emission standards apply for engines and

optionally powertrains measured using the test procedures specified in subpart F of this part as follows:

(1) CO<sub>2</sub> emission standards in this paragraph (a)(1) apply based on testing as specified in subpart F of this part. The applicable test cycle for measuring CO<sub>2</sub> emissions differs depending on the engine family's primary intended service class and the extent to which the engines will be (or were designed to be) used in tractors. For Medium HDE and Heavy HDE certified as tractor engines, measure CO<sub>2</sub> emissions using the SET steady-state duty cycle specified in § 1036.510. This testing with the SET duty cycle is intended for engines designed to be used primarily in tractors and other line-haul applications. Note that the use of some SET-certified tractor engines in vocational applications does not affect your certification obligation under this paragraph (a)(1); see other provisions of this part and 40 CFR part 1037 for limits

on using engines certified to only one cycle. For Medium HDE and Heavy HDE certified as both tractor and vocational engines, measure CO<sub>2</sub> emissions using the SET duty cycle specified in § 1036.510 and the FTP transient duty cycle specified in § 1036.512. Testing with both SET and FTP duty cycles is intended for engines that are designed for use in both tractor and vocational applications. For all other engines (including Spark-ignition HDE), measure CO<sub>2</sub> emissions using the FTP transient duty cycle specified in § 1036.512.

(i) The Phase 1 CO<sub>2</sub> standard is 627 g/hp-hr for all spark-ignition engines for model years 2016 through 2020. This standard continues to apply in later model years for all spark-ignition engines that are not Heavy HDE.

(ii) The following Phase 1 CO<sub>2</sub> standards apply for compression-ignition engines (in g/hp-hr):

TABLE 1 TO PARAGRAPH (a)(1)(ii) OF § 1036.108—COMPRESSION-IGNITION ENGINE STANDARDS FOR MODEL YEARS 2014–2020

Model years	Light HDE	Medium HDE—vocational	Heavy HDE—vocational	Medium HDE—tractor	Heavy HDE—tractor
2014–2016 .....	600	600	567	502	475
2017–2020 .....	576	576	555	487	460

(iii) The following Phase 2 CO<sub>2</sub> standards apply for compression-ignition engines and all Heavy HDE (in g/hp-hr):

TABLE 2 TO PARAGRAPH (a)(1)(iii) OF § 1036.108—COMPRESSION-IGNITION ENGINE STANDARDS FOR MODEL YEARS 2021 AND LATER

Model years	Light HDE	Medium HDE—vocational	Heavy HDE—vocational	Medium HDE—tractor	Heavy HDE—tractor
2021–2023 .....	563	545	513	473	447
2024–2026 .....	555	538	506	461	436
2027 and later .....	552	535	503	457	432

(iv) You may certify spark-ignition engines to the compression-ignition standards for the appropriate model year under this paragraph (a). If you do this, those engines are treated as compression-ignition engines for all the provisions of this part.

(2) The CH<sub>4</sub> emission standard is 0.10 g/hp-hr when measured over the applicable FTP transient duty cycle specified in § 1036.512. This standard begins in model year 2014 for compression-ignition engines and in model year 2016 for spark-ignition engines. Note that this standard applies for all fuel types just like the other standards of this section.

(3) The N<sub>2</sub>O emission standard is 0.10 g/hp-hr when measured over the applicable FTP transient duty cycle

specified in § 1036.512. This standard begins in model year 2014 for compression-ignition engines and in model year 2016 for spark-ignition engines.

(b) *Family Certification Levels.* You must specify a CO<sub>2</sub> Family Certification Level (FCL) for each engine family expressed to the same number of decimal places as the emission standard. The FCL may not be less than the certified emission level for the engine family. The CO<sub>2</sub> family emission limit (FEL) for the engine family is equal to the FCL multiplied by 1.03.

(c) *Averaging, banking, and trading.* You may generate or use emission credits under the averaging, banking, and trading (ABT) program described in subpart H of this part for demonstrating

compliance with CO<sub>2</sub> emission standards. Credits (positive and negative) are calculated from the difference between the FCL and the applicable emission standard. As described in § 1036.705, you may use CO<sub>2</sub> credits to certify your engine families to FELs for N<sub>2</sub>O and/or CH<sub>4</sub>, instead of the N<sub>2</sub>O/CH<sub>4</sub> standards of this section that otherwise apply. Except as specified in §§ 1036.150 and 1036.705, you may not generate or use credits for N<sub>2</sub>O or CH<sub>4</sub> emissions.

(d) *Useful life.* The exhaust emission standards of this section apply for the useful life, expressed as vehicle miles, or hours of engine operation, or years in service, whichever comes first, as follows:

TABLE 3 TO PARAGRAPH (d) OF § 1036.108—USEFUL LIFE BY PRIMARY INTENDED SERVICE CLASS FOR MODEL YEAR 2021 AND LATER

Primary intended service class	Miles	Years
Spark-ignition HDE <sup>a</sup> .....	150,000	15
Light HDE <sup>a</sup> .....	150,000	15
Medium HDE .....	185,000	10
Heavy HDE <sup>b</sup> .....	435,000	10

<sup>a</sup> Useful life for Spark-ignition HDE and Light HDE before model year 2021 is 110,000 miles or 10 years, whichever occurs first.

<sup>b</sup> Useful life for Heavy HDE is also expressed as 22,000 operating hours. For an individual engine, the useful life is no shorter than 10 years or 100,000 miles, whichever occurs first, regardless of operating hours.

(e) *Applicability for testing.* The emission standards in this subpart apply as specified in this paragraph (e) to all duty-cycle testing (according to the applicable test cycles) of testable configurations, including certification, selective enforcement audits, and in-use testing. The CO<sub>2</sub> FCLs serve as the CO<sub>2</sub> emission standards for the engine family with respect to certification and confirmatory testing instead of the standards specified in paragraph (a)(1) of this section. The FELs serve as the emission standards for the engine family with respect to all other duty-cycle testing. See §§ 1036.235 and 1036.241 to determine which engine configurations within the engine family are subject to testing. Note that engine fuel maps and powertrain test results also serve as

standards as described in §§ 1036.535, 1036.540, and 1036.630 and 40 CFR 1037.550.

**§ 1036.110 Diagnostic controls.**

Onboard diagnostic (OBD) systems must generally detect malfunctions in the emission control system, store trouble codes corresponding to detected malfunctions, and alert operators appropriately. Starting in model year 2027, new engines must have OBD systems as described in this section. You may optionally comply with any or all of the requirements of this section instead of 40 CFR 86.010–18 in earlier model years.

(a) Chassis-based OBD requirements apply instead of the requirements of this section for certain engines as follows:

(1) Heavy-duty engines intended to be installed in heavy-duty vehicles at or below 14,000 pounds GVWR must meet the requirements in 40 CFR 86.1806. Note that 40 CFR 86.1806 allows for using later versions of specified OBD requirements from the California Air Resources Board, which includes meeting the 2019 heavy-duty OBD requirements adopted for California and updated emission thresholds as described in this section.

(2) Heavy-duty spark-ignition engines intended to be installed in heavy-duty vehicles above 14,000 pounds GVWR may meet the requirements in 40 CFR 86.1806 if the same engines are also installed in vehicles certified under 40 CFR part 86, subpart S, where both sets

of vehicles share similar emission controls.

(b) Engines must comply with the 2019 heavy-duty OBD requirements adopted for California as described in this paragraph (b). California's 2019 heavy-duty OBD requirements are part of 13 CCR 1968.2, 1968.5, 1971.1, and 1971.5 (incorporated by reference in § 1036.810). We may approve your request to certify an OBD system meeting alternative specifications if you submit information as needed to demonstrate that it meets the intent of this section. For example, we may approve your request for a system that meets a later version of California's OBD requirements if you demonstrate that it meets the intent of this section; the demonstration must include identification of any approved deficiencies and your plans to resolve such deficiencies. To demonstrate that your engine meets the intent of this section, the OBD system meeting alternative specifications must address all the provisions described in this paragraph (b) and in paragraph (c) of this section. The following clarifications and exceptions apply for engines certified under this part:

(1) We may approve a small manufacturer's request to delay complying with the requirements of this section for up to three model years if that manufacturer has not certified those engines or other comparable engines in California for those model years.

(2) For engines not certified in California, references to vehicles meeting certain California Air Resources Board emission standards are understood to refer to the corresponding EPA emission standards for a given family, where applicable. Use good engineering judgment to correlate the specified standards with the EPA standards that apply under this part. You must describe in your application for certification how you will perform testing to demonstrate compliance with OBD requirements to represent all your engine families over five or fewer model years.

(3) Engines must comply with OBD requirements throughout the useful life as specified in § 1036.104(e).

(4) The purpose and applicability statements in 13 CCR 1971.1(a) and (b) do not apply.

(5) Emission thresholds apply as follows:

(i) Spark-ignition engines are subject to a NO<sub>x</sub> threshold of 0.35 g/hp-hr for catalyst monitoring and 0.30 g/hp-hr in all other cases. Spark-ignition engines are subject to a PM threshold of 0.015 g/hp-hr. Thresholds apply for operation on the FTP and SET duty cycles.

(ii) Compression-ignition engines are subject to a NO<sub>x</sub> threshold of 0.40 g/hp-hr and a PM threshold of 0.03 g/hp-hr for operation on the FTP and SET duty cycles.

(iii) All engines are subject to HC and CO thresholds as specified in 13 CCR 1968.2 and 1971.1, except that the "applicable standards" for determining these thresholds are 0.14 g/hp-hr for HC, 14.4 g/hp-hr for CO from spark-ignition engines, and 15.5 g/hp-hr for CO from compression-ignition engines.

(iv) Compression-ignition engines may be exempt from certain monitoring in 13 CCR 1968.2 and 1971.1 based on specified test-out criteria. To calculate these test-out criteria, the "applicable standards" are 0.20 g/hp-hr for NO<sub>x</sub>, 0.14 g/hp-hr for HC, 0.01 g/hp-hr for PM, 14.4 g/hp-hr for CO from spark-ignition engines, and 15.5 g/hp-hr for CO from compression-ignition engines.

(6) The provisions related to verification of in-use compliance in 13 CCR 1971.1(l) do not apply. The provisions related to manufacturer self-testing in 13 CCR 1971.5(c) also do not apply.

(7) The deficiency provisions described in paragraph (d) of this section apply instead of 13 CCR 1971.1(k).

(8) Include the additional data-stream signals in 13 CCR 1971.1(h)(4.2.3)(E), (F), and (G) as freeze-frame conditions as required in 13 CCR 1971.1(h)(4.3).

(9) Design compression-ignition engines to make the following additional data-stream signals available on demand with a generic scan tool according to 13 CCR 1971.1(h)(4.2), if the engine is so equipped:

(i) *Engine and vehicle parameters.* Status of parking brake, neutral switch, brake switch, and clutch switch, wastegate control solenoid output, wastegate position (commanded and actual), speed and output shaft torque consistent with § 1036.115(d).

(ii) *Diesel oxidation catalyst parameters.* Include inlet and outlet pressure and temperature for the diesel oxidation catalyst.

(iii) *Particulate filter parameters.* Include filter soot load and ash load for all installed particulate filters.

(iv) *EGR parameters.* Include differential pressure for exhaust gas recirculation.

(v) *SCR parameters.* Include DEF quality-related signals, DEF coolant control valve position (commanded and actual), DEF tank temperature, DEF system pressure, DEF pump commanded percentage, DEF doser control status, DEF line heater control outputs, aftertreatment dosing quantity commanded and actual.

(vi) *Derating parameters.* Include any additional parameters used to apply inducements under § 1036.111 or any other SCR-related or DPF-related engine derates under § 1036.125.

(10) Design spark-ignition engines to make the following additional parameters available for reading with a generic scan tool, if applicable:

(i) *Air-fuel enrichment parameters.* Percent of time in enrichment, both for each trip (key-on to key-off) and as a cumulative lifetime value. Track values separately for enrichment based on throttle, engine protection, and catalyst protection. Include all time after engine warm-up when the engine is not operating at the air-fuel ratio designed for peak three-way catalyst efficiency. Peak efficiency typically involves closed-loop feedback control.

(ii) [Reserved]

(11) If you have an approved Executive order from the California Air Resources Board for a given engine family, we may rely on that Executive order to evaluate whether you meet federal OBD requirements for that same engine family or an equivalent engine family. Engine families are equivalent if they are identical in all aspects material to emission characteristics; for example, we would consider different inducement strategies and different warranties not to be material to emission characteristics relevant to these OBD testing requirements. EPA would count two equivalent engine families as one for the purposes of determining OBD demonstration testing requirements. Send us the following information:

(i) You must submit additional information as needed to demonstrate that you meet the requirements of this section that are not covered by the California Executive order.

(ii) Send us results from any testing you performed for certifying engine families (including equivalent engine families) with the California Air Resources Board, including the results of any testing performed under 13 CCR 1971.1(l) for verification of in-use compliance and 13 CCR 1971.5(c) for manufacturer self-testing within the deadlines set out in 13 CCR 1971.1.

(iii) We may require that you send us additional information if we need it to evaluate whether you meet the requirements of this paragraph (b)(11). This may involve sending us copies of documents you send to the California Air Resources Board.

(12) You may ask us to approve conditions for which the diagnostic system may disregard trouble codes, as described in 13 CCR 1971.1(g)(5.3)–(5.6).

(13) References to the California ARB Executive Officer are deemed to be the EPA Administrator.

(c) Design the diagnostic system to display the following information in the cab:

(1) For inducements specified in § 1036.111 and any other AECD that derates engine output related to SCR or DPF systems, indicate the fault code for the detected problem, a description of the fault code, and the current speed restriction. For inducement faults under § 1036.111, identify whether the fault condition is for DEF quantity, DEF quality, or tampering; for other faults, identify whether the fault condition is related to SCR or DPF systems. If there are additional derate stages, also indicate the next speed restriction and the time remaining until starting the next restriction. If the derate involves something other than restricting vehicle speed, such as a torque derate, adjust the information to correctly identify any current and pending restrictions.

(2) Identify on demand the total number of diesel particulate filter regeneration events that have taken place since installing the current particulate filter.

(3) Identify on demand the historical and current rate of DEF consumption, such as gallons of DEF consumed per mile or gallons of DEF consumed per gallon of diesel fuel consumed. Design the system to allow the operator to reset the current rate of DEF consumption.

(d) You may ask us to accept as compliant an engine that does not fully meet specific requirements under this section. The following provisions apply regarding OBD system deficiencies:

(1) We will not approve a deficiency for gasoline-fueled or diesel-fueled engines if it involves the complete lack of a major diagnostic monitor, such as monitors related to exhaust aftertreatment devices, oxygen sensors, air-fuel ratio sensors, NO<sub>x</sub> sensors, engine misfire, evaporative leaks, and diesel EGR (if applicable). We may approve such deficiencies for engines using other fuels if you demonstrate that the alternative fuel causes these monitors to be unreliable.

(2) We will approve a deficiency only if you show us that full compliance is infeasible or unreasonable considering any relevant factors, such as the

technical feasibility of a given monitor, or the lead time and production cycles of vehicle designs and programmed computing upgrades.

(3) Our approval for a given deficiency applies only for a single model year, though you may continue to ask us to extend a deficiency approval in renewable one-year increments. We may approve an extension if you demonstrate an acceptable level of progress toward compliance and you show that the necessary hardware or software modifications would pose an unreasonable burden. We will approve a deficiency for more than three years only if you further demonstrate that you need the additional lead time to make substantial changes to engine hardware.

(4) We will not approve deficiencies retroactively.

**§ 1036.111 Inducements related to SCR.**

Engines using SCR to control emissions depend on a constant supply of diesel exhaust fluid (DEF). This section describes how manufacturers must design their engines to derate power output to induce operators to take appropriate actions to ensure the SCR system is working properly. The requirements of this section apply equally for engines installed in heavy-duty vehicles at or below 14,000 lbs GVWR. The requirements of this section apply starting in model year 2027, though you may comply with the requirements of this section in earlier model years.

(a) *General provisions.* The following terms and general provisions apply under this section:

(1) As described in § 1036.110, this section relies on terms and requirements specified for OBD systems by California ARB in 13 CCR 1968.2 and 1971.1 (incorporated by reference in § 1036.810).

(2) The provisions of this section apply differently based on an individual vehicle's speed history. A vehicle's speed category is based on the OBD system's recorded value for average speed for the preceding 30 hours of non-idle engine operation. The vehicle speed category applies at the point that the engine first detects a fault condition identified under paragraph (b) of this section and continues to apply until the fault condition is fully resolved as specified in paragraph (e) of this

section. Non-idle engine operation includes all operating conditions except those that qualify as idle based on OBD system controls as specified in 13 CCR 1971.1(h)(5.4.10). Apply speed derates based on the following categories:

**TABLE 1 TO PARAGRAPH (a)(2) OF § 1036.111—VEHICLE CATEGORIES**

Vehicle category	Average speed (mi/hr)
Low-speed .....	speed <15.
Medium-speed .....	15 ≤speed <25.
High-speed .....	speed ≥25.

(3) Where engines derate power output as specified in this section, the derate must decrease vehicle speed by 1 mi/hr for every five minutes of engine operation until reaching the specified derate speed. This requirement applies at the onset of an inducement, at any transition to a different step of inducement, and for any derate that recurs under paragraph (e)(3) of this section.

(b) *Fault conditions.* Create derate strategies that monitor for and trigger an inducement based on the following conditions:

(1) DEF supply falling to a level corresponding to three hours of engine operation, based on available information on DEF consumption rates.

(2) DEF quality failing to meet your concentration specifications.

(3) Any signal indicating that a catalyst is missing.

(4) Open circuit faults related to the following: DEF tank level sensor, DEF pump, DEF quality sensor, SCR wiring harness, NO<sub>x</sub> sensors, DEF dosing valve, DEF tank heater, DEF tank temperature sensor, and aftertreatment control module.

(c) [Reserved]

(d) *Derate schedule.* Engines must follow the derate schedule described in this paragraph (d) if the engine detects a fault condition identified in paragraph (b) of this section. The derate takes the form of a maximum drive speed for the vehicle. This maximum drive speed decreases over time based on hours of non-idle engine operation without regard to engine starting.

(1) Apply speed-limiting derates according to the following schedule:

TABLE 2 TO PARAGRAPH (d)(1) OF § 1036.111—DERATE SCHEDULE FOR DETECTED FAULTS

High-speed vehicles		Low-speed vehicles		Low-speed vehicles	
Hours of non-idle engine operation	Maximum speed (mi/hr)	Hours of non-idle engine operation	Maximum speed (mi/hr)	Hours of non-idle engine operation	Maximum speed (mi/hr)
0	65	0	55	0	45
6	60	6	50	5	40
12	55	12	45	10	35
20	50	45	40	30	25
86	45	70	35	.....	.....
119	40	90	25	.....	.....
144	35	.....	.....	.....	.....
164	25	.....	.....	.....	.....

<sup>a</sup>Hours start counting when the engine detects a fault condition specified in paragraph (b) of this section. For DEF supply, you may program the engine to reset the timer to three hours when the engine detects an empty DEF tank.

(2) You may design and produce engines that will be installed in motorcoaches with an alternative derate schedule that starts with a 65 mi/hr derate when a fault condition is first detected, steps down to 50 mi/hr after 80 hours, and concludes with a final derate speed of 25 mi/hr after 180 hours of non-idle operation.

(e) *Deactivating derates.* Program the engine to deactivate derates as follows:

(1) Evaluate whether the detected fault condition continues to apply. Deactivate derates if the engine confirms that the detected fault condition is resolved.

(2) Allow a generic scan tool to deactivate inducement-related fault codes while the vehicle is not in motion.

(3) Treat any detected fault condition that recurs within 40 hours of engine operation as the same detected fault condition, which would restart the derate at the same point in the derate schedule that the system last deactivated the derate.

**§ 1036.115 Other requirements.**

Engines that are required to meet the emission standards of this part must meet the following requirements, except as noted elsewhere in this part:

(a) *Crankcase emissions.* Engines may not discharge crankcase emissions into the ambient atmosphere throughout the useful life, other than those that are routed to the exhaust upstream of exhaust aftertreatment during all operation, except as follow:

(1) Engines equipped with turbochargers, pumps, blowers, or superchargers for air induction may discharge crankcase emissions to the ambient atmosphere if the emissions are added to the exhaust emissions (either physically or mathematically) during all emission testing.

(2) If you take advantage of this exception, you must manufacture the engines so that all crankcase emissions

can be routed into the applicable sampling systems specified in 40 CFR part 1065. You must also account for deterioration in crankcase emissions when determining exhaust deterioration factors as described in § 1036.240(c)(5).

(b) *Fuel mapping.* You must perform fuel mapping for your engine as described in § 1036.505(b).

(c) *Evaporative and refueling emissions.* You must design and produce your engines to comply with evaporative and refueling emission standards as follows:

(1) For complete heavy-duty vehicles you produce, you must certify the vehicles to emission standards as specified in 40 CFR 1037.103.

(2) For incomplete heavy-duty vehicles, and for engines used in vehicles you do not produce, you do not need to certify your engines to evaporative and refueling emission standards or otherwise meet those standards. However, vehicle manufacturers certifying their vehicles with your engines may depend on you to produce your engines according to their specifications. Also, your engines must meet applicable exhaust emission standards in the installed configuration.

(d) *Torque broadcasting.* Electronically controlled engines must broadcast their speed and output shaft torque (in newton-meters). Engines may alternatively broadcast a surrogate value for determining torque. Engines must broadcast engine parameters such that they can be read with a remote device or broadcast them directly to their controller area networks.

(e) *EPA access to broadcast information.* If we request it, you must provide us any hardware, tools, and information we would need to readily read, interpret, and record all information broadcast by an engine's on-board computers and electronic control modules. If you broadcast a surrogate parameter for torque values,

you must provide us what we need to convert these into torque units. We will not ask for hardware or tools if they are readily available commercially.

(f) *Adjustable parameters.* Engines that have adjustable parameters must meet all the requirements of this part for any adjustment in the practically adjustable range.

(1) We may require that you set adjustable parameters to any specification within the practically adjustable range during any testing, including certification testing, selective enforcement auditing, or in-use testing.

(2) General provisions apply for adjustable parameters as specified in 40 CFR 1068.50.

(3) DEF supply and DEF quality are adjustable parameters. The physically adjustable range includes any amount of DEF for which the engine's diagnostic system does not trigger inducement provisions under § 1036.111.

(g) *Prohibited controls.* (1) *General provisions.* You may not design your engines with emission control devices, systems, or elements of design that cause or contribute to an unreasonable risk to public health, welfare, or safety while operating. For example, this would apply if the engine emits a noxious or toxic substance it would otherwise not emit that contributes to such an unreasonable risk.

(2) *Vanadium sublimation in SCR catalysts.* For engines equipped with vanadium-based SCR catalysts, you must design the engine and its emission controls to prevent vanadium sublimation and protect the catalyst from high temperatures. We will evaluate your engine design based on the following information that you must include in your application for certification:

(i) Identify the threshold temperature for vanadium sublimation for your specified SCR catalyst formulation as

described in 40 CFR 1065.1113 through 1065.1121.

(ii) Describe how you designed your engine to prevent catalyst inlet temperatures from exceeding the temperature you identify in paragraph (g)(2)(i) of this section, including consideration of engine wear through the useful life. Also describe your design for catalyst protection in case catalyst temperatures exceed the specified temperature. In your description, include how you considered elevated catalyst temperature resulting from sustained high-load engine operation, catalyst exotherms, particulate filter regeneration, and component failure resulting in unburned fuel in the exhaust stream.

(h) *Defeat devices.* You may not equip your engines with a defeat device. A defeat device is an auxiliary emission control device (AECED) that reduces the effectiveness of emission controls under conditions that may reasonably be expected in normal operation and use. However, an AECED is not a defeat device if you identify it in your application for certification and any of the following is true:

(1) The conditions of concern were substantially included in the applicable procedure for duty-cycle testing as described in subpart F of this part.

(2) You show your design is necessary to prevent engine (or vehicle) damage or accidents. Preventing engine damage includes preventing damage to aftertreatment or other emission-related components.

(3) The reduced effectiveness applies only to starting the engine.

(4) The AECED applies only for engines that will be installed in *emergency*

*vehicles*, and the need is justified in terms of preventing the engine from losing speed, torque, or power due abnormal conditions of the emission control system, or in terms of preventing such abnormal conditions from occurring, during operation related to emergency response. Examples of such abnormal conditions may include excessive exhaust backpressure from an overloaded particulate trap, and running out of diesel exhaust fluid for engines that rely on urea-based selective catalytic reduction.

(i) *DEF tanks.* Diesel exhaust fluid tanks must be sized to require refilling no more frequently than the vehicle operator will need to refill the fuel tank, even for worst-case assumptions related to fuel efficiency and refueling volumes.

(j) *Special provisions for spark-ignition engines.* The following provisions apply for spark-ignition engines that control air-fuel ratios at or near stoichiometry starting with model year 2027:

(1) Catalyst bed temperature during extended idle may not fall below 350 °C, or a lower temperature that we approve. Describe how you designed your engine to meet this requirement in your application for certification. You may ask us to approve alternative strategies to prevent emissions from increasing during idle.

(2) In addition to the information requirements of § 1036.205(b), describe why you rely on any AECEDs instead of other engine designs for thermal protection of catalyst or other emission-related components. Also describe the accuracy of any modeled or measured temperatures used to activate the AECED. We may ask you to submit a second-by-

second comparison of any modeled and measured component temperatures as part of your application for certification.

**§ 1036.120 Emission-related warranty requirements.**

(a) *General requirements.* You must warrant to the ultimate purchaser and each subsequent purchaser that the new engine, including all parts of its emission control system, meets two conditions:

(1) It is designed, built, and equipped so it conforms at the time of sale to the ultimate purchaser with the requirements of this part.

(2) It is free from defects in materials and workmanship that may keep it from meeting these requirements.

(b) *Warranty period.* Your emission-related warranty must be valid for at least as long as the minimum warranty periods listed in this paragraph (b) in vehicle miles, or hours of engine operation, or years in service, whichever comes first. You may offer an emission-related warranty more generous than we require. The emission-related warranty for the engine may not be shorter than any published warranty you offer without charge for the engine. Similarly, the emission-related warranty for any component may not be shorter than any published warranty you offer without charge for that component. If an extended warranty requires owners to pay for a portion of repairs, those terms apply in the same manner to the emission-related warranty. The warranty period begins when the vehicle is placed into service. The following minimum warranty periods apply:

TABLE 1 TO PARAGRAPH (b) OF § 1036.120—WARRANTY BY PRIMARY INTENDED SERVICE CLASS

Primary intended service class	Model year 2026 and earlier			Model year 2027 and later		
	Mileage	Years	Hours	Mileage	Years	Hours
Spark-Ignition HDE .....	50,000	5	.....	160,000	10	8,000
Light HDE .....	50,000	5	.....	210,000	10	10,000
Medium HDE .....	100,000	5	.....	280,000	10	14,000
Heavy HDE .....	100,000	5	.....	450,000	10	22,000

(c) *Components covered.* The emission-related warranty covers all components listed in 40 CFR part 1068, appendix A, and components from any other system you develop to control emissions. The emission-related warranty covers any components, regardless of the company that produced them, that are the original components or the same design as

components from the certified configuration.

(d) *Limited applicability.* You may deny warranty claims under this section if the operator caused the problem through improper maintenance or use, subject to the provisions in § 1036.125 and 40 CFR 1068.115.

(e) *Owners manual.* Describe in the owners manual the emission-related

warranty provisions from this section that apply to the engine.

**§ 1036.125 Maintenance instructions and allowable maintenance.**

Maintenance includes any inspection, adjustment, cleaning, repair, or replacement of components and is classified as either emission-related or not emission-related and each of these can be classified as either scheduled or



unscheduled. Further, some emission-related maintenance is also classified as critical emission-related maintenance. Give the ultimate purchaser of each new engine written instructions for maintaining and using the engine. As described in paragraph (h) of this section, these instructions must identify how owners properly maintain and use engines to clarify responsibilities for regulatory requirements such as emission-related warranty and defect reporting.

(a) *Critical emission-related maintenance.* Critical emission-related maintenance includes any adjustment, cleaning, repair, or replacement of components listed in paragraph (a)(2) of this section. Critical emission-related maintenance may also include other maintenance that you determine is critical, including maintenance on other emission-related components as described in 40 CFR part 1068, appendix A, if we approve it in advance. You may perform scheduled critical emission-related maintenance during service accumulation on your emission-data engines at the intervals you specify.

(1) *Maintenance demonstration.* You must demonstrate that the maintenance

is reasonably likely to be done at your recommended intervals on in-use engines. We will accept DEF replenishment as reasonably likely to occur if your engine meets the specifications in § 1036.111. We will accept other scheduled maintenance as reasonably likely to occur if you satisfy any of the following conditions:

(i) You present data showing that, if a lack of maintenance increases emissions, it also unacceptably degrades the engine's performance.

(ii) You design and produce your engines with a system we approve that displays a visible signal to alert drivers that maintenance is due, either as a result of component failure or the appropriate degree of engine or vehicle operation. The signal must clearly display "maintenance needed", "check engine", or a similar message that we approve. The signal must be continuous while the engine is operating and not be easily eliminated without performing the specified maintenance. Your maintenance instructions must specify resetting the signal after completing the specified maintenance. We must approve the method for resetting the signal. You may not design the system to be less effective at the end of the

useful life. If others install your engine in their vehicle, you may rely on installation instructions to ensure proper mounting and operation of the display. Disabling or improperly resetting the system for displaying these maintenance-related signals without performing the indicated maintenance violates the tampering prohibition in 42 U.S.C. 7522(a)(3).

(iii) You present survey data showing that at least 80 percent of engines in the field get the maintenance you specify at the recommended intervals.

(iv) You provide the maintenance free of charge and clearly say so in your maintenance instructions.

(v) You otherwise show us that the maintenance is reasonably likely to be done at the recommended intervals.

(2) *Minimum scheduled maintenance intervals.* You may not schedule critical emission-related maintenance more frequently than the minimum intervals specified or allowed in this paragraph (a), except as specified in paragraph (g) of this section. The minimum intervals specified for each component applies to actuators, sensors, tubing, valves, and wiring associated with that component, except as specified.

TABLE 1 TO PARAGRAPH (a)(2) OF § 1036.125—MINIMUM SCHEDULED MAINTENANCE INTERVALS FOR REPLACEMENT IN MILES (OR HOURS)

Components	Spark-ignition HDE	Light HDE	Medium HDE	Heavy HDE
Spark plugs .....	25,000 (750)	.....	.....	.....
DEF filters .....	.....	100,000 (3,000)	100,000 (3,000)	100,000 (3,000)
Crankcase ventilation valves and filters .....	60,000 (1,800)	60,000 (1,800)	60,000 (1,800)	60,000 (1,800)
Ignition wires and coils .....	50,000 (1,500)	.....	.....	.....
Oxygen sensors .....	80,000 (2,400)	.....	.....	.....
Air injection system components .....	110,000 (3,300)	.....	.....	.....
Sensors, actuators, and related control modules that are not integrated into other systems .....	100,000 (3,000)	100,000 (3,000)	150,000 (4,500)	150,000 (4,500)
Particulate filtration systems (other than filter substrates) .....	100,000 (3,000)	100,000 (3,000)	250,000 (7,500)	250,000 (7,500)
Catalyst systems (other than catalyst substrates), fuel injectors, electronic control modules, hybrid system components, turbochargers, and EGR system components (including filters and coolers) ..	110,000 (3,300)	110,000 (3,300)	185,000 (5,550)	435,000 (13,050)
Catalyst substrates and particulate filter substrates .....	200,000 (10,000)	270,000 (13,000)	350,000 (17,000)	650,000 (32,000)

TABLE 2 TO PARAGRAPH (a)(2) OF § 1036.125—MINIMUM SCHEDULED MAINTENANCE INTERVALS FOR ADJUSTMENT OR CLEANING

Component	Accumulated miles (hours) for components			
	Spark-ignition HDE	Light HDE	Medium HDE	Heavy HDE
Spark plugs .....	25,000 (750)	.....	.....	.....
EGR-related filters and coolers, fuel injectors, and crankcase ventilation valves and filters.	50,000 (1,500)	50,000 (1,500)	50,000 (1,500)	50,000 (1,500)
DEF filters .....	.....	50,000 (1,500)	50,000 (1,500)	50,000 (1,500)

TABLE 2 TO PARAGRAPH (a)(2) OF § 1036.125—MINIMUM SCHEDULED MAINTENANCE INTERVALS FOR ADJUSTMENT OR CLEANING—Continued

Component	Accumulated miles (hours) for components			
	Spark-ignition HDE	Light HDE	Medium HDE	Heavy HDE
Ignition wires and coils .....	50,000 (1,500)			
Oxygen sensors .....	80,000 (2,400)			
Air injection system components .....	100,000 (3,000)			
Catalyst system components, EGR system components (other than filters or coolers), particulate filtration system components, and turbochargers.	100,000 (3,000)	100,000 (3,000)	100,000 (3,000), then 50,000 (4,500).	100,000 (3,000), then 150,000 (4,500)

(3) *New technology.* You may ask us to approve scheduled critical emission-related maintenance of components not identified in paragraph (a)(2) of this section that is a direct result of the implementation of new technology not used in model year 2020 or earlier engines, subject to the following provisions:

(i) Your request must include your recommended maintenance interval, including data to support the need for the maintenance, and a demonstration that the maintenance is likely to occur at the recommended interval using one of the conditions specified in paragraph (a)(1) of this section.

(ii) For any such new technology, we will publish a **Federal Register** notice based on information you submit and any other available information to announce that we have established new allowable minimum maintenance intervals. Any manufacturer objecting to our decision may ask for a hearing (see § 1036.820).

(4) *System components.* The following provisions clarify which components are included in certain systems:

(i) Catalyst system refers to the aftertreatment assembly used for gaseous emission control and generally includes catalyst substrates, substrate housings, exhaust gas temperature sensors, gas concentration sensors, and related control modules. SCR-based catalyst systems also include DEF level sensors, DEF quality sensors, and DEF temperature sensors.

(ii) Particulate filtration system refers to the aftertreatment assembly used for exhaust PM filtration and generally includes filter substrates, substrate housings, pressure sensors, pressure lines and tubes, exhaust gas temperature sensors, fuel injectors for active regeneration, and related control modules.

(b) *Recommended additional maintenance.* You may recommend any amount of critical emission-related maintenance that is additional to what we approve in paragraph (a) of this

section, as long as you state clearly that the recommended additional maintenance steps are not necessary to keep the emission-related warranty valid. If operators do the maintenance specified in paragraph (a) of this section, but not the recommended additional maintenance, this does not allow you to disqualify those engines from in-use testing or deny a warranty claim. Do not take these maintenance steps during service accumulation on your emission-data engines.

(c) *Special maintenance.* You may specify more frequent maintenance to address problems related to special situations, such as atypical engine operation. For example, you may specify more frequent maintenance if operators fuel the engine with an alternative fuel such as biodiesel. You must clearly state that this special maintenance is associated with the special situation you are addressing. We may disapprove your maintenance instructions if we determine that you have specified special maintenance steps to address engine operation that is not atypical, or that the maintenance is unlikely to occur in use. If we determine that certain maintenance items do not qualify as special maintenance under this paragraph (c), you may identify them as recommended additional maintenance under paragraph (b) of this section.

(d) *Noncritical emission-related maintenance.* You may specify any amount of emission-related inspection or other maintenance that is not approved critical emission-related maintenance under paragraph (a) of this section, subject to the provisions of this paragraph (d). Noncritical emission-related maintenance generally includes maintenance on the components we specify in 40 CFR part 1068, appendix A, that is not covered in paragraph (a) of this section. You must state in the owners manual that these steps are not necessary to keep the emission-related warranty valid. If operators fail to do

this maintenance, this does not allow you to disqualify those engines from in-use testing or deny a warranty claim. Do not take these inspection or other maintenance steps during service accumulation on your emission-data engines.

(e) *Maintenance that is not emission-related.* You may schedule any amount of maintenance unrelated to emission controls that is needed for proper functioning of the engine. This might include adding engine oil; changing air, fuel, or oil filters; servicing engine-cooling systems; adjusting idle speed, governor, engine bolt torque, valve lash, injector lash, timing, or tension of air pump drive belts; and lubricating the heat control valve in the exhaust manifold. For maintenance that is not emission-related, you may perform the maintenance during service accumulation on your emission-data engines at the least frequent intervals that you recommend to the ultimate purchaser (but not the intervals recommended for special situations).

(f) [Reserved]

(g) *Payment for scheduled maintenance.* Owners are responsible for properly maintaining their engines, which generally includes paying for scheduled maintenance. However, you may commit to paying for scheduled maintenance as described in paragraph (a)(1)(iv) of this section to demonstrate that the maintenance will occur. You may also schedule maintenance not otherwise allowed by paragraph (a)(2) of this section if you pay for it. You must pay for scheduled maintenance on any component during the useful life if it meets all the following conditions:

(1) Each affected component was not in general use on similar engines before 1980.

(2) The primary function of each affected component is to reduce emissions.

(3) The cost of the maintenance is more than 2 percent of the price of the engine.

(4) Failure to perform the maintenance would not cause clear problems that would significantly degrade the engine's performance.

(h) *Owners manual.* Include the following maintenance-related information in the owners manual, consistent with the requirements of this section:

(1) Clearly describe the scheduled maintenance steps, consistent with the provisions of this section, using nontechnical language as much as possible. Include a list of components for which you will cover scheduled replacement costs.

(2) Identify all maintenance you consider necessary for the engine to be considered properly maintained for purposes of making valid warranty claims. Describe what documentation you consider appropriate for making these demonstrations. Note that you may identify failure to repair critical emission-related components as improper maintenance if the repairs are related to an observed defect. Your maintenance instructions under this section may not require components or service identified by brand, trade, or corporate name. Also, do not directly or indirectly require that the engine be serviced by your franchised dealers or any other service establishments with which you have a commercial relationship. However, you may disregard these limitations on your maintenance requirements if you do one of the following things:

(i) Provide a component or service without charge under the purchase agreement.

(ii) Get us to waive this prohibition in the public's interest by convincing us the engine will work properly only with the identified component or service.

(3) Describe how the owner can access the OBD system to troubleshoot problems and find emission-related diagnostic information and codes stored in onboard monitoring systems as described in § 1036.110(b) and (c). These instructions must at a minimum include identification of the OBD communication protocol used, location and type of OBD connector, brief description of what OBD is (including type of information stored, what a MIL is, and explanation that some MILs may self-extinguish), and a note that generic scan tools can provide engine maintenance information.

(4) Describe the elements of the emission control system and provide an overview of how they function.

(5) Include one or more diagrams of the engine and its emission-related components with the following information:

(i) The flow path for intake air and exhaust gas.

(ii) The flow path of evaporative and refueling emissions for spark-ignition engines, and DEF for compression-ignition engines, as applicable.

(iii) The flow path of engine coolant if it is part of the emission control system described in the application for certification.

(iv) The identity, location, and arrangement of relevant sensors, DEF heater and other DEF delivery components, and other critical emission-related components. Terminology to identify components must be consistent with codes you use for the OBD system.

(6) Include one or more exploded-view drawings that allow the owner to identify the following components: EGR valve, EGR actuator, EGR cooler, all emission sensors (such as NO<sub>x</sub> sensors and soot sensors), temperature and pressure sensors (such as sensors related to EGR, DPF, DOC, and SCR and DEF), quality sensors, DPF filter, DOC, SCR catalyst, fuel (DPF-related) and DEF dosing units and components (e.g., pumps, metering units, filters, nozzles, valves, injectors), aftertreatment-related control modules, any other DEF delivery-related components (such as delivery lines and freeze-protection components), and separately replaceable aftertreatment-related wiring harnesses. Terminology to identify components must be consistent with codes you use for the OBD system. Include part numbers for sensors and filters related to SCR and DPF systems for the current model year or any earlier model year.

(7) Include the following statement: "Technical service bulletins, emission-related recalls, and other information for your engine may be available at [www.nhtsa.gov/recalls](http://www.nhtsa.gov/recalls)."

(8) Include a troubleshooting guide to address the following warning signals related to SCR inducement:

(i) The inducement derate schedule (including indication that inducements will begin prior to the DEF tank being completely empty).

(ii) The meaning of any trouble lights that indicate specific problems (e.g., DEF level).

(iii) A description of the three types of SCR-related derates (DEF quality, DEF quality and tampering) and that further information on the inducement cause (e.g., trouble codes) is available using the OBD system.

(9) Describe how to access OBD fault codes related to DPF-related derates.

(10) Identify a website for the service information required in 40 CFR 86.010–38(j).

#### § 1036.130 Installation instructions for vehicle manufacturers.

(a) If you sell an engine for someone else to install in a vehicle, give the engine installer instructions for installing it consistent with the requirements of this part. Include all information necessary to ensure that an engine will be installed in its certified configuration.

(b) Make sure these instructions have the following information:

(1) Include the heading: "Emission-related installation instructions".

(2) State: "Failing to follow these instructions when installing a certified engine in a heavy-duty motor vehicle violates federal law, subject to fines or other penalties as described in the Clean Air Act."

(3) Provide all instructions needed to properly install the exhaust system and any other components. Include any appropriate instructions for configuring the exhaust system in the vehicle to allow for collecting emission samples for in-use testing where that is practical.

(4) Describe any necessary steps for installing any diagnostic system required under § 1036.110.

(5) Describe how your certification is limited for any type of application. For example, if you certify Heavy HDE to the CO<sub>2</sub> standards using only transient FTP testing, you must make clear that the engine may not be installed in tractors.

(6) Describe any other instructions to make sure the installed engine will operate according to design specifications in your application for certification. This may include, for example, instructions for installing aftertreatment devices when installing the engines.

(7) Give the following instructions if you do not ship diesel exhaust fluid tanks with your engines:

(i) Specify that vehicle manufacturers must install diesel exhaust fluid tanks meeting the specifications of § 1036.115(i).

(ii) Describe how vehicle manufacturers must install diesel exhaust fluid tanks with sensors as needed to meet the requirements of §§ 1036.110 and 1036.111.

(8) State: "If you install the engine in a way that makes the engine's emission control information label hard to read during normal engine maintenance, you must place a duplicate label on the vehicle, as described in 40 CFR 1068.105."

(9) Describe how vehicle manufacturers need to apply stickers to qualifying vehicles as described in § 1036.136 if you certify engines to the

Clean Idle NO<sub>x</sub> standard of § 1036.104(b).

(c) Give the vehicle manufacturer fuel map results as described in § 1036.505(b).

(d) You do not need installation instructions for engines that you install in your own vehicles.

(e) Provide instructions in writing or in an equivalent format. For example, you may post instructions on a publicly available website for downloading or printing. If you do not provide the instructions in writing, explain in your application for certification how you will ensure that each installer is informed of the installation requirements.

#### § 1036.135 Labeling.

(a) Assign each engine a unique identification number and permanently affix, engrave, or stamp it on the engine in a legible way.

(b) At the time of manufacture, affix a permanent and legible label identifying each engine. The label must meet the requirements of 40 CFR 1068.45.

(c) The label must—

(1) Include the heading “EMISSION CONTROL INFORMATION”.

(2) Include your full corporate name and trademark. You may identify another company and use its trademark instead of yours if you comply with the branding provisions of 40 CFR 1068.45.

(3) Include EPA’s standardized designation for the engine family.

(4) Identify the primary intended service class.

(5) State the engine’s displacement (in liters); however, you may omit this from the label if all the engines in the engine family have the same per-cylinder displacement and total displacement.

(6) State the date of manufacture [DAY (optional), MONTH, and YEAR]; however, you may omit this from the label if you stamp, engrave, or otherwise permanently identify it elsewhere on the engine, in which case you must also describe in your application for certification where you will identify the date on the engine.

(7) State the NO<sub>x</sub> FEL to which the engines are certified if applicable. Identify the Clean Idle standard if you certify the engine to the NO<sub>x</sub> standard of § 1036.104(b).

(8) State: “THIS ENGINE COMPLIES WITH U.S. EPA REGULATIONS FOR [MODEL YEAR] HEAVY-DUTY HIGHWAY ENGINES.”

(9) Identify any limitations on your certification. For example, if you certify Heavy HDE to the CO<sub>2</sub> standards using only steady-state testing, include the statement “TRACTORS ONLY”.

Similarly, for engines with one or more approved AECDs for emergency vehicle applications under § 1036.115(h)(4), the statement: “THIS ENGINE IS FOR INSTALLATION IN EMERGENCY VEHICLES ONLY”.

(d) You may add information to the emission control information label as follows:

(1) You may identify other emission standards that the engine meets or does not meet. You may add the information about the other emission standards to the statement we specify, or you may include it in a separate statement.

(2) You may add other information to ensure that the engine will be properly maintained and used.

(3) You may add appropriate features to prevent counterfeit labels. For example, you may include the engine’s unique identification number on the label.

(e) You may ask us to approve modified labeling requirements in this part if you show that it is necessary or appropriate. We will approve your request if your alternate label is consistent with the requirements of this part. We may also specify modified labeling requirements to be consistent with the intent of 40 CFR part 1037.

(f) If you obscure the engine label while installing the engine in the vehicle such that the label cannot be read during normal maintenance, you must place a duplicate label on the vehicle. If others install your engine in their vehicles in a way that obscures the engine label, we require them to add a duplicate label on the vehicle (see 40 CFR 1068.105); in that case, give them the number of duplicate labels they request and keep the following records for at least five years:

(1) Written documentation of the request from the vehicle manufacturer.

(2) The number of duplicate labels you send for each engine family and the date you sent them.

#### § 1036.136 Clean Idle sticker.

(a) Design and produce stickers showing that your engines meet the federal Clean Idle standard if you certify engines to the Clean Idle NO<sub>x</sub> standard of § 1036.104(b). The sticker must—

(1) Meet the requirements of 40 CFR 1068.45 for permanent labels. The preferred location for sticker placement is on the driver’s side of the hood.

(2) Include one or both of your corporate name and trademark.

(3) Identify that the engine is qualified to meet the federal Clean Idle NO<sub>x</sub> standard.

(4) Include a serial number or other method to confirm that stickers have been properly applied to vehicles.

(b) The following provisions apply for placing Clean Idle stickers on vehicles with installed engines that have been certified to the NO<sub>x</sub> standard of § 1036.104(b):

(1) If you install engines in vehicles you produce, you must apply a sticker to each vehicle certified to the Clean Idle standard.

(2) If you ship engines for others to install in vehicles, include in your purchasing documentation the manufacturer’s request for a specific number of labels corresponding to the number of engines ordered. Supply the vehicle manufacturer with exactly one sticker for each shipped engine certified to the Clean Idle standard. Prepare your emission-related installation instructions to ensure that vehicle manufacturers meet all application requirements. Keep the following records for at least five years:

(i) Written documentation of the vehicle manufacturer’s request for stickers.

(ii) Tracking information for stickers you send and the date you sent them.

(c) The provisions in 40 CFR 1068.101 apply for the Clean Idle sticker in the same way that those provisions apply for emission control information labels.

#### § 1036.140 Primary intended service class and engine cycle.

You must identify a single primary intended service class for each engine family that best describes vehicles for which you design and market the engine, as follows:

(a) Divide compression-ignition engines into primary intended service classes based on the following engine and vehicle characteristics:

(1) Light HDE includes engines that are not designed for rebuild and do not have cylinder liners. Vehicle body types in this group might include any heavy-duty vehicle built from a light-duty truck chassis, van trucks, multi-stop vans, and some straight trucks with a single rear axle. Typical applications would include personal transportation, light-load commercial delivery, passenger service, agriculture, and construction. The GVWR of these vehicles is normally at or below 19,500 pounds.

(2) Medium HDE includes engines that may be designed for rebuild and may have cylinder liners. Vehicle body types in this group would typically include school buses, straight trucks with single rear axles, city tractors, and a variety of special purpose vehicles such as small dump trucks, and refuse trucks. Typical applications would include commercial short haul and intra-city delivery and pickup. Engines

in this group are normally used in vehicles whose GVWR ranges from 19,501 to 33,000 pounds.

(3) Heavy HDE includes engines that are designed for multiple rebuilds and have cylinder liners. Vehicles in this group are normally tractors, trucks, straight trucks with dual rear axles, and buses used in inter-city, long-haul applications. These vehicles normally exceed 33,000 pounds GVWR.

(b) Divide spark-ignition engines into primary intended service classes as follows:

(1) Spark-ignition engines that are best characterized by paragraph (a)(1) or (2) of this section are in a separate Spark-ignition HDE primary intended service class.

(2) Spark-ignition engines that are best characterized by paragraph (a)(3) of this section are included in the Heavy HDE primary intended service class along with compression-ignition engines. Gasoline-fueled engines are presumed not to be characterized by paragraph (a)(3) of this section; for example, vehicle manufacturers may install some number of gasoline-fueled engines in Class 8 trucks without causing the engine manufacturer to consider those to be Heavy HDE.

(c) References to “spark-ignition standards” in this part relate only to the spark-ignition engines identified in paragraph (b)(1) of this section. References to “compression-ignition standards” in this part relate to compression-ignition engines, to spark-ignition engines optionally certified to standards that apply to compression-ignition engines, and to all engines identified under paragraph (b)(2) of this section as Heavy HDE.

#### § 1036.150 Interim provisions.

The provisions in this section apply instead of other provisions in this part. This section describes when these interim provisions expire, if applicable.

(a) *Transitional ABT credits for NO<sub>x</sub> emissions.* You may generate NO<sub>x</sub> credits from model year 2026 and earlier engines and use those as transitional credits for model year 2027 and later engines using any of the following methods:

(1) *Discounted credits.* Generate discounted credits by certifying any model year 2022 through 2026 engine family to meet all the requirements that apply under 40 CFR part 86, subpart A. Calculate discounted credits for certifying engines in model years 2027 through 2029 as described in § 1036.705 relative to a NO<sub>x</sub> emission standard of 200 mg/hp-hr and multiply the result by 0.6. You may not use discounted credits

for certifying model year 2030 and later engines.

(2) *Partial credits.* Generate partial credits by certifying any model year 2024 through 2026 compression-ignition engine family as described in this paragraph (a)(2). You may not use partial credits for certifying model year 2033 and later engines. Certify engines for partial credits to meet all the requirements that apply under 40 CFR part 86, subpart A, with the following adjustments:

(i) Calculate credits as described in § 1036.705 relative to a NO<sub>x</sub> emission standard of 200 mg/hp-hr using the appropriate useful life mileage from 40 CFR 86.004–2. Your declared NO<sub>x</sub> family emission limit applies for the FTP and SET duty cycles.

(ii) Engines must meet a NO<sub>x</sub> standard when tested over the Low Load Cycle as described in § 1036.514. Engines must also meet an off-cycle NO<sub>x</sub> standard as specified in § 1036.104(a)(3). Calculate the NO<sub>x</sub> family emission limits for the Low Load Cycle and for off-cycle testing as described in § 1036.104(c)(3) with  $Std_{FTPNO_x}$  set to 35 mg/hp-hr and  $Std_{[cycle]NO_x}$  set to the values specified in § 1036.104(a)(2) or (3), respectively. No standard applies for HC, PM, and CO emissions for the Low Load Cycle or for off-cycle testing, but you must record measured values for those pollutants and include those measured values where you report NO<sub>x</sub> emission results.

(iii) For engines selected for in-use testing, we may specify that you perform testing as described in 40 CFR part 86, subpart T, or as described in subpart E of this part.

(iv) Add the statement “Partial credit” to the emission control information label.

(3) *Full credits.* Generate full credits by certifying any model year 2024 through 2026 engine family to meet all the requirements that apply under this part. Calculate credits as described in § 1036.705 relative to a NO<sub>x</sub> emission standard of 200 mg/hp-hr. You may not use full credits for certifying model year 2033 and later engines.

(4) *2026 service class pull-ahead credits.* Generate credits from diesel-fueled engines under this paragraph (a)(4) by certifying all your model year 2026 diesel-fueled Heavy HDE to meet all the requirements that apply under this part, with a NO<sub>x</sub> family emission limit for FTP testing at or below 50 mg/hp-hr. Calculate credits as described in § 1036.705 relative to a NO<sub>x</sub> emission standard of 200 mg/hp-hr. You may use credits generated under this paragraph (a)(4) through model year 2034, but not for later model years. Credits generated

by Heavy HDE may be used for certifying Medium HDE after applying a 10 percent discount (multiply credits by 0.9). Engine families using credits generated under this paragraph (a)(4) are subject to a NO<sub>x</sub> FEL cap of 50 mg/hp-hr for FTP testing.

(b) *Model year 2014 N<sub>2</sub>O standards.* In model year 2014 and earlier, manufacturers may show compliance with the N<sub>2</sub>O standards using an engineering analysis. This allowance also applies for later families certified using carryover CO<sub>2</sub> data from model 2014 consistent with § 1036.235(d).

(c) *Engine cycle classification.* Through model year 2020, engines meeting the definition of spark-ignition, but regulated as compression-ignition engines under § 1036.140, must be certified to the requirements applicable to compression-ignition engines under this part. Such engines are deemed to be compression-ignition engines for purposes of this part. Similarly, through model year 2020, engines meeting the definition of compression-ignition, but regulated as Otto-cycle under 40 CFR part 86 must be certified to the requirements applicable to spark-ignition engines under this part. Such engines are deemed to be spark-ignition engines for purposes of this part. See § 1036.140 for provisions that apply for model year 2021 and later.

(d) *Small manufacturers.* The greenhouse gas standards of this part apply on a delayed schedule for manufacturers meeting the small business criteria specified in 13 CFR 121.201. Apply the small business criteria for NAICS code 336310 for engine manufacturers with respect to gasoline-fueled engines and 333618 for engine manufacturers with respect to other engines; the employee limits apply to the total number employees together for affiliated companies. Qualifying small manufacturers are not subject to the greenhouse gas emission standards in § 1036.108 for engines with a date of manufacture on or after November 14, 2011 but before January 1, 2022. In addition, qualifying small manufacturers producing engines that run on any fuel other than gasoline, E85, or diesel fuel may delay complying with every later greenhouse gas standard under this part by one model year. Small manufacturers may certify their engines and generate emission credits under this part before standards start to apply, but only if they certify their entire U.S.-directed production volume within that averaging set for that model year. Note that engines not yet subject to standards must nevertheless supply fuel maps to vehicle manufacturers as described in paragraph (n) of this

section. Note also that engines produced by small manufacturers are subject to criteria pollutant standards.

(e) *Alternate phase-in standards for greenhouse gas emissions.* Where a manufacturer certifies all of its model year 2013 compression-ignition engines

within a given primary intended service class to the applicable alternate standards of this paragraph (e), its compression-ignition engines within that primary intended service class are subject to the standards of this

paragraph (e) for model years 2013 through 2016. This means that once a manufacturer chooses to certify a primary intended service class to the standards of this paragraph (e), it is not allowed to opt out of these standards.

TABLE 1 TO PARAGRAPH (e) OF § 1036.150—ALTERNATE PHASE-IN STANDARDS (g/hp-hr)

Vehicle type	Model years	Light HDE	Medium HDE	Heavy HDE
Tractors .....	2013–2015 .....	NA .....	512 g/hp-hr .....	485 g/hp-hr.
	2016 and later <sup>a</sup> .....	NA .....	487 g/hp-hr .....	460 g/hp-hr.
Vocational .....	2013–2015 .....	618 g/hp-hr .....	618 g/hp-hr .....	577 g/hp-hr.
	2016 through 2020 <sup>a</sup> .....	576 g/hp-hr .....	576 g/hp-hr .....	555 g/hp-hr.

<sup>a</sup> **Note:** these alternate standards for 2016 and later are the same as the otherwise applicable standards for 2017 through 2020.

(f) [Reserved]

(g) *Default deterioration factors for greenhouse gas standards.* You may use default deterioration factors (DFs) without performing your own durability emission tests or engineering analysis as follows:

(1) You may use a default additive DF of 0.0 g/hp-hr for CO<sub>2</sub> emissions from engines that do not use advanced or off-cycle technologies. If we determine it to be consistent with good engineering judgment, we may allow you to use a

default additive DF of 0.0 g/hp-hr for CO<sub>2</sub> emissions from your engines with advanced or off-cycle technologies.

(2) You may use a default additive DF of 0.010 g/hp-hr for N<sub>2</sub>O emissions from any engine through model year 2021, and 0.020 g/hp-hr for later model years.

(3) You may use a default additive DF of 0.020 g/hp-hr for CH<sub>4</sub> emissions from any engine.

(h) *Advanced-technology credits.* If you generate CO<sub>2</sub> credits from model year 2020 and earlier engines certified

for advanced technology, you may multiply these credits by 1.5.

(i) *CO<sub>2</sub> credits for low N<sub>2</sub>O emissions.*

If you certify your model year 2014, 2015, or 2016 engines to an N<sub>2</sub>O FEL less than 0.04 g/hp-hr (provided you measure N<sub>2</sub>O emissions from your emission-data engines), you may generate additional CO<sub>2</sub> credits under this paragraph (i). Calculate the additional CO<sub>2</sub> credits from the following equation instead of the equation in § 1036.705:

$$CO_2 \text{ credits (Mg)} = (0.04 - FEL_{N_2O}) \cdot CF \cdot Volume \cdot UL \cdot 10^{-6} \cdot 298$$

Eq. 1036.150-1

(j) *Alternate standards under 40 CFR part 86.* This paragraph (j) describes alternate emission standards for loose engines certified under 40 CFR 86.1819–14(k)(8). The standards of § 1036.108 do not apply for these engines. The standards in this paragraph (j) apply for emissions measured with the engine installed in a complete vehicle consistent with the provisions of 40 CFR 86.1819–14(k)(8)(vi). The only requirements of this part that apply to these engines are those in this paragraph (j), §§ 1036.115 through 1036.135, 1036.535, and 1036.540.

(k) *Limited production volume allowance under ABT.* You may produce a limited number of Heavy HDE that continue to meet the standards that applied under 40 CFR 86.007–11 in model years 2027 through 2029. The maximum number of engines you may produce under this limited production allowance is 5 percent of the annual average of your actual U.S.-directed production volume of Heavy HDE in model years 2023–2025. Engine certification under this paragraph (k) is subject to the following conditions and requirements:

(1) Engines must meet all the standards and other requirements that apply under 40 CFR part 86 for model year 2026. Engine must be certified in separate engine families that qualify for carryover certification as described in § 1036.235(d).

(2) The NO<sub>x</sub> FEL must be at or below 200 mg/hp-hr. Calculate negative credits as described in § 1036.705 by comparing the NO<sub>x</sub> FEL to the FTP emission standard specified in § 1036.104(a)(1), with a value for useful life of 650,000 miles. Meet the credit reporting and recordkeeping requirements in §§ 1036.730 and 1036.735.

(3) Label the engine as described in 40 CFR 86.095–35, but include the following alternate compliance statement: “THIS ENGINE CONFORMS TO U.S. EPA REGULATIONS FOR MODEL YEAR 2026 ENGINES UNDER 40 CFR 1036.150(k).”

(l) *Credit adjustment for spark-ignition engines and light heavy-duty compression-ignition engines.* For greenhouse gas emission credits generated from model year 2020 and earlier spark-ignition and light heavy-duty engines, multiply any banked CO<sub>2</sub> credits that you carry forward to

demonstrate compliance with model year 2021 and later standards by 1.36.

(m) *Infrequent regeneration.* For model year 2020 and earlier, you may invalidate any test interval with respect to CO<sub>2</sub> measurements if an infrequent regeneration event occurs during the test interval. Note that § 1036.580 specifies how to apply infrequent regeneration adjustment factors for later model years.

(n) *Supplying fuel maps.* Engine manufacturers not yet subject to standards under § 1036.108 in model year 2021 must supply vehicle manufacturers with fuel maps (or powertrain test results) as described in § 1036.130 for those engines.

(o) *Engines used in glider vehicles.* For purposes of recertifying a used engine for installation in a glider vehicle, we may allow you to include in an existing certified engine family those engines you modify (or otherwise demonstrate) to be identical to engines already covered by the certificate. We would base such an approval on our review of any appropriate documentation. These engines must have emission control information

labels that accurately describe their status.

(p) *Transition to Phase 2 CO<sub>2</sub> standards.* If you certify all your model year 2020 engines within an averaging set to the model year 2021 FTP and SET standards and requirements, you may

apply the provisions of this paragraph (p) for enhanced generation and use of emission credits. These provisions apply separately for Medium HDE and Heavy HDE.

(1) Greenhouse gas emission credits you generate with model year 2018

through 2024 engines may be used through model year 2030, instead of being limited to a five-year credit life as specified in § 1036.740(d).

(2) You may certify your model year 2024 through 2026 engines to the following alternative standards:

TABLE 2 TO PARAGRAPH (p)(2) OF § 1036.150—ALTERNATIVE STANDARDS FOR MODEL YEARS 2024 THROUGH 2026

Model years	Medium heavy-duty-vocational	Heavy heavy-duty-vocational	Medium heavy-duty-tractor	Heavy heavy-duty-tractor
2024–2026 .....	542	510	467	442

(q) *Confirmatory testing of fuel maps defined in § 1036.505(b).* For model years 2021 and later, where the results from Eq. 1036.235–1 for a confirmatory test are at or below 2.0%, we will not replace the manufacturer’s fuel maps.

(r) *Fuel maps for the transition to updated GEM.* (1) You may use fuel maps from model year 2023 and earlier engines for certifying model year 2024 and later engines using carryover provisions in § 1036.235(d).

(2) Compliance testing will be based on the GEM version you used to generate fuel maps for certification. For example, if you perform a selective enforcement audit with respect to fuel maps, use the same GEM version that you used to generate fuel maps for certification. Similarly, we will use the same GEM version that you used to generate fuel maps for certification if we perform confirmatory testing with one of your engine families.

(s) *Greenhouse gas compliance testing.* Select duty cycles and measure emissions to demonstrate compliance with greenhouse gas emission standards before model year 2027 as follows:

(1) For model years 2016 through 2020, measure emissions using the FTP duty cycle specified in § 1036.512 and the SET duty cycle specified in 40 CFR 86.1362, as applicable.

(2) The following provisions apply for model years 2021 through 2026:

(i) Determine criteria pollutant emissions during any testing used to demonstrate compliance with greenhouse gas emission standards; however, the duty-cycle standards of § 1036.104 apply for measured criteria pollutant emissions only as described in subpart F of this part.

(ii) You may demonstrate compliance with SET-based greenhouse gas emission standards in § 1036.108(a)(1) using the SET duty cycle specified in 40 CFR 86.1362 if you collect emissions with continuous sampling. Integrate the test results by mode to establish separate emission rates for each mode

(including the transition following each mode, as applicable). Apply the CO<sub>2</sub> weighting factors specified in 40 CFR 86.1362 to calculate a composite emission result.

(t) *Model year 2027 compliance date.* The following provisions describe when this part 1036 starts to apply for model year 2027 engines:

(1) *Split model year.* Model year 2027 engines you produce before December 20, 2026 are subject to the criteria standards and related provisions in 40 CFR part 86, subpart A, as described in § 1036.1(a). Model year 2027 engines you produce on or after December 20, 2026 are subject to all the provisions of this part.

(2) *Optional early compliance.* You may optionally certify model year 2027 engines you produce before December 20, 2026 to all the provisions of this part.

(3) *Certification.* If you certify any model year 2027 engines to 40 CFR part 86, subpart A, under paragraph (t)(1) of this section, certify the engine family by dividing the model year into two partial model years. The first portion of the model year starts when it would normally start and ends when you no longer produce engines meeting standards under 40 CFR part 86, subpart A, on or before December 20, 2026. The second portion of the model year starts when you begin producing engines meeting standards under this part 1036, and ends on the day your model year would normally end. The following additional provisions apply for model year 2027 if you split the model year as described in this paragraph (t):

(i) You may generate emission credits only with engines that are certified under this part 1036.

(ii) In your production report under § 1036.250(a), identify production volumes separately for the two parts of the model year.

(iii) OBD testing demonstrations apply singularly for the full model year.

(u) *Crankcase emissions.* The provisions of 40 CFR 86.007–11(c) for crankcase emissions continue to apply through model year 2026.

(v) *OBD communication protocol.* We may approve the alternative communication protocol specified in SAE J1979–2 (incorporated by reference in § 1036.810) if the protocol is approved by the California Air Resources Board. The alternative protocol would apply instead of SAE J1939 and SAE J1979 as specified in 40 CFR 86.010–18(k)(1). Engines designed to comply with SAE J1979–2 must meet the freeze-frame requirements in § 1036.110(b)(8) and in 13 CCR 1971.1(h)(4.3.2) (incorporated by reference in § 1036.810). This paragraph (v) also applies for model year 2026 and earlier engines.

(w) *Greenhouse gas warranty.* For model year 2027 and later engines, you may ask us to approve the model year 2026 warranty periods specified in § 1036.120 for components or systems needed to comply with greenhouse gas emission standards if those components or systems do not play a role in complying with criteria pollutant standards.

(x) *Powertrain testing for criteria pollutants.* You may apply the powertrain testing provisions of § 1036.101(b) for demonstrating compliance with criteria pollutant emission standards in 40 CFR part 86 before model year 2027.

(y) *NO<sub>x</sub> compliance allowance for in-use testing.* A NO<sub>x</sub> compliance allowance of 15 mg/hp-hr applies for any in-use testing of Medium HDE and Heavy HDE as described in subpart E of this part. Add the compliance allowance to the NO<sub>x</sub> standard that applies for each duty cycle and for off-cycle testing, with both field testing and laboratory testing. The NO<sub>x</sub> compliance allowance does not apply for the bin 1 off-cycle standard. As an example, for manufacturer-run field-testing of a

Heavy HDE, add the 15 mg/hp-hr compliance allowance and the 5 mg/hp-hr accuracy margin from § 1036.420 to the 58 mg/hp-hr-bin 2 off-cycle standard to calculate a 78 mg/hp-hr NO<sub>x</sub> standard.

(z) *Alternate family pass criteria for in-use testing.* The following family pass criteria apply for manufacturer-run in-use testing instead of the pass criteria described in § 1036.425 for model years 2027 and 2028:

(1) Start by measuring emissions from five engines using the procedures described in subpart E of this part and § 1036.530. If four or five engines comply fully with the off-cycle bin standards, the engine family passes and you may stop testing.

(2) If exactly two of the engines tested under paragraph (z)(1) of this section do not comply fully with the off-cycle bin standards, test five more engines. If these additional engines all comply fully with the off-cycle bin standards, the engine family passes and you may stop testing.

(3) If three or more engines tested under paragraphs (z)(1) and (2) of this section do not comply fully with the off-cycle bin standards, test a total of at least 10 but not more than 15 engines. Calculate the arithmetic mean of the bin emissions from all the engine tests as specified in § 1036.530(g) for each pollutant. If the mean values are at or below the off-cycle bin standards, the engine family passes. If the mean value for any pollutant is above an off-cycle bin standard, the engine family fails.

### Subpart C—Certifying Engine Families

#### § 1036.201 General requirements for obtaining a certificate of conformity.

(a) You must send us a separate application for a certificate of conformity for each engine family. A certificate of conformity is valid from the indicated effective date until December 31 of the model year for which it is issued.

(b) The application must contain all the information required by this part and must not include false or incomplete statements or information (see § 1036.255).

(c) We may ask you to include less information than we specify in this subpart, as long as you maintain all the information required by § 1036.250.

(d) You must use good engineering judgment for all decisions related to your application (see 40 CFR 1068.5).

(e) An authorized representative of your company must approve and sign the application.

(f) See § 1036.255 for provisions describing how we will process your application.

(g) We may require you to deliver your test engines to a facility we designate for our testing (see § 1036.235(c)). Alternatively, you may choose to deliver another engine that is identical in all material respects to the test engine, or another engine that we determine can appropriately serve as an emission-data engine for the engine family.

(h) For engines that become new after being placed into service, such as rebuilt engines installed in new vehicles, we may specify alternate certification provisions consistent with the intent of this part. See 40 CFR 1068.120(h) and the definition of “new motor vehicle engine” in § 1036.801.

#### § 1036.205 Requirements for an application for certification.

This section specifies the information that must be in your application, unless we ask you to include less information under § 1036.201(c). We may require you to provide additional information to evaluate your application.

(a) Identify the engine family’s primary intended service class and describe how that conforms to the specifications in § 1036.140. Also, describe the engine family’s specifications and other basic parameters of the engine’s design and emission controls with respect to compliance with the requirements of this part. List the fuel type on which your engines are designed to operate (for example, gasoline, diesel fuel, or natural gas). For engines that can operate on multiple fuels, identify whether they are dual-fuel or flexible-fuel engines; also identify the range of mixtures for operation on blended fuels, if applicable. List each engine configuration in the engine family. List the rated power for each engine configuration.

(b) Explain how the emission control system operates. Describe in detail all system components for controlling greenhouse gas and criteria pollutant emissions, including all auxiliary emission control devices (AECs) and all fuel-system components you will install on any production or test engine. Identify the part number of each component you describe. For this paragraph (b), treat as separate AECs any devices that modulate or activate differently from each other. Include all the following:

(1) Give a general overview of the engine, the emission control strategies, and all AECs.

(2) Describe each AEC’s general purpose and function.

(3) Identify the parameters that each AEC senses (including measuring,

estimating, calculating, or empirically deriving the values). Include engine-based parameters and state whether you simulate them during testing with the applicable procedures.

(4) Describe the purpose for sensing each parameter.

(5) Identify the location of each sensor the AEC uses.

(6) Identify the threshold values for the sensed parameters that activate the AEC.

(7) Describe the parameters that the AEC modulates (controls) in response to any sensed parameters, including the range of modulation for each parameter, the relationship between the sensed parameters and the controlled parameters and how the modulation achieves the AEC’s stated purpose. Use graphs and tables, as necessary.

(8) Describe each AEC’s specific calibration details. This may be in the form of data tables, graphical representations, or some other description.

(9) Describe the hierarchy among the AECs when multiple AECs sense or modulate the same parameter. Describe whether the strategies interact in a comparative or additive manner and identify which AEC takes precedence in responding, if applicable.

(10) Explain the extent to which the AEC is included in the applicable test procedures specified in subpart F of this part.

(11) Do the following additional things for AECs designed to protect engines or vehicles:

(i) Identify any engine and vehicle design limits that make protection necessary and describe any damage that would occur without the AEC.

(ii) Describe how each sensed parameter relates to the protected components’ design limits or those operating conditions that cause the need for protection.

(iii) Describe the relationship between the design limits/parameters being protected and the parameters sensed or calculated as surrogates for those design limits/parameters, if applicable.

(iv) Describe how the modulation by the AEC prevents engines and vehicles from exceeding design limits.

(v) Explain why it is necessary to estimate any parameters instead of measuring them directly and describe how the AEC calculates the estimated value, if applicable.

(vi) Describe how you calibrate the AEC modulation to activate only during conditions related to the stated need to protect components and only as needed to sufficiently protect those components in a way that minimizes the emission impact.



(c) Explain in detail how the engine diagnostic system works, describing especially the engine conditions (with the corresponding diagnostic trouble codes) that cause the malfunction indicator to go on. You may ask us to approve conditions under which the diagnostic system disregards trouble codes as described in § 1036.110.

(d) Describe the engines you selected for testing and the reasons for selecting them.

(e) Describe any test equipment and procedures that you used, including any special or alternate test procedures you used (see § 1036.501).

(f) Describe how you operated the emission-data engine before testing, including the duty cycle and the number of engine operating hours used to stabilize emission levels. Explain why you selected the method of service accumulation. Describe any scheduled maintenance you did.

(g) List the specifications of the test fuel to show that it falls within the required ranges we specify in 40 CFR part 1065.

(h) Identify the engine family's useful life.

(i) Include the warranty statement and maintenance instructions you will give to the ultimate purchaser of each new engine (see §§ 1036.120 and 1036.125).

(j) Include the emission-related installation instructions you will provide if someone else installs your engines in their vehicles (see § 1036.130).

(k) Describe your emission control information label (see § 1036.135). We may require you to include a copy of the label.

(l) Identify the duty-cycle emission standards from §§ 1036.104(a) and (b) and 1036.108(a) that apply for the engine family. Also identify FELs and FCLs as follows:

(1) Identify the NO<sub>x</sub> FEL over the FTP for the engine family.

(2) Identify the CO<sub>2</sub> FCLs for the engine family; also identify any FELs that apply for CH<sub>4</sub> and N<sub>2</sub>O. The actual U.S.-directed production volume of configurations that have CO<sub>2</sub> emission rates at or below the FCL and CH<sub>4</sub> and N<sub>2</sub>O emission rates at or below the applicable standards or FELs must be at least one percent of your actual (not projected) U.S.-directed production volume for the engine family. Identify configurations within the family that have emission rates at or below the FCL and meet the one percent requirement. For example, if your U.S.-directed production volume for the engine family is 10,583 and the U.S.-directed production volume for the tested rating is 75 engines, then you can comply with

this provision by setting your FCL so that one more rating with a U.S.-directed production volume of at least 31 engines meets the FCL. Where applicable, also identify other testable configurations required under § 1036.230(f)(2)(ii).

(m) Identify the engine family's deterioration factors and describe how you developed them (see §§ 1036.240 and 1036.241). Present any test data you used for this. For engines designed to discharge crankcase emissions to the ambient atmosphere, use the deterioration factors for crankcase emission to determine deteriorated crankcase emission levels of NO<sub>x</sub>, HC, PM, and CO as specified in § 1036.240(e).

(n) State that you operated your emission-data engines as described in the application (including the test procedures, test parameters, and test fuels) to show you meet the requirements of this part.

(o) Present emission data from all valid tests on an emission-data engine to show that you meet emission standards. Note that § 1036.235 allows you to submit an application in certain cases without new emission data. Present emission data as follows:

(1) For hydrocarbons (such as NMHC or NMHCE), NO<sub>x</sub>, PM, and CO, as applicable, show your engines meet the applicable exhaust emission standards we specify in § 1036.104. Show emission figures for duty-cycle exhaust emission standards before and after applying adjustment factors for regeneration and deterioration factors for each engine.

(2) For CO<sub>2</sub>, CH<sub>4</sub>, and N<sub>2</sub>O, show that your engines meet the applicable emission standards we specify in § 1036.108. Show emission figures before and after applying deterioration factors for each engine. In addition to the composite results, show individual measurements for cold-start testing and hot-start testing over the transient test cycle. For each of these tests, also include the corresponding exhaust emission data for criteria emissions.

(3) If we specify more than one grade of any fuel type (for example, a summer grade and winter grade of gasoline), you need to submit test data only for one grade, unless the regulations of this part specify otherwise for your engine.

(p) State that all the engines in the engine family comply with the off-cycle emission standards we specify in § 1036.104 for all normal operation and use when tested as specified in § 1036.530. Describe any relevant testing, engineering analysis, or other information in sufficient detail to support your statement. We may direct

you to include emission measurements representing typical engine in-use operation at a range of ambient conditions. For example, we may specify certain transient and steady-state engine operation that is typical for the types of vehicles that use your engines. See § 1036.210.

(q) We may ask you to send information to confirm that the emission data you submitted were from valid tests meeting the requirements of this part and 40 CFR part 1065. You must indicate whether there are test results from invalid tests or from any other tests of the emission-data engine, whether or not they were conducted according to the test procedures of subpart F of this part. We may require you to report these additional test results.

(r) Describe all adjustable operating parameters (see § 1036.115(f)), including production tolerances. For any operating parameters that do not qualify as adjustable parameters, include a description supporting your conclusion (see 40 CFR 1068.50(c)). Include the following in your description of each adjustable parameter:

(1) For practically adjustable operating parameters, include the nominal or recommended setting, the intended practically adjustable range, and the limits or stops used to establish adjustable ranges. State that the limits, stops, or other means of inhibiting adjustment are effective in preventing adjustment of parameters on in-use engines to settings outside your intended practically adjustable ranges and provide information to support this statement.

(2) For programmable operating parameters, state that you have restricted access to electronic controls to prevent parameter adjustment on in-use engines that would allow operation outside the practically adjustable range. Describe how your engines are designed to prevent unauthorized adjustments.

(s) Provide the information to read, record, and interpret all the information broadcast by an engine's onboard computers and ECMs as described in § 1036.115(d). State that, upon request, you will give us any hardware, software, or tools we would need to do this.

(t) State whether your certification is limited for certain engines. For example, you might certify engines only for use in tractors, in emergency vehicles, or in vehicles with hybrid powertrains. If this is the case, describe how you will prevent use of these engines in vehicles for which they are not certified.

(u) Unconditionally certify that all the engines in the engine family comply with the requirements of this part, other referenced parts of the CFR, and the

Clean Air Act. Note that § 1036.235 specifies which engines to test to show that engines in the entire family comply with the requirements of this part.

(v) Include good-faith estimates of nationwide production volumes. Include a justification for the estimated production volumes if they are substantially different than actual production volumes in earlier years for similar models.

(w) Include the information required by other subparts of this part. For example, include the information required by § 1036.725 if you participate in the ABT program.

(x) Include other applicable information, such as information specified in this part or 40 CFR part 1068 related to requests for exemptions.

(y) Name an agent for service located in the United States. Service on this agent constitutes service on you or any of your officers or employees for any action by EPA or otherwise by the United States related to the requirements of this part.

(z) For imported engines, identify the following:

(1) Describe your normal practice for importing engines. For example, this may include identifying the names and addresses of anyone you have authorized to import your engines. Engines imported by nonauthorized agents are not covered by your certificate.

(2) The location of a test facility in the United States where you can test your engines if we select them for testing under a selective enforcement audit, as specified in 40 CFR part 1068, subpart E.

(aa) Include information needed to certify vehicles to greenhouse gas standards under 40 CFR part 1037 as described in § 1036.505.

#### **§ 1036.210 Preliminary approval before certification.**

If you send us information before you finish the application, we may review it and make any appropriate determinations, especially for questions related to engine family definitions, auxiliary emission control devices, adjustable parameters, deterioration factors, testing for service accumulation, and maintenance. Decisions made under this section are considered to be preliminary approval, subject to final review and approval. We will generally not reverse a decision where we have given you preliminary approval, unless we find new information supporting a different decision. If you request preliminary approval related to the upcoming model year or the model year after that, we will make best-efforts to

make the appropriate determinations as soon as practicable. We will generally not provide preliminary approval related to a future model year more than two years ahead of time.

#### **§ 1036.225 Amending applications for certification.**

Before we issue you a certificate of conformity, you may amend your application to include new or modified engine configurations, subject to the provisions of this section. After we have issued your certificate of conformity, you may send us an amended application any time before the end of the model year requesting that we include new or modified engine configurations within the scope of the certificate, subject to the provisions of this section. You must also amend your application if any changes occur with respect to any information that is included or should be included in your application.

(a) You must amend your application before you take any of the following actions:

(1) Add an engine configuration to an engine family. In this case, the engine configuration added must be consistent with other engine configurations in the engine family with respect to the design aspects listed in § 1036.230.

(2) Change an engine configuration already included in an engine family in a way that may affect emissions, or change any of the components you described in your application for certification. This includes production and design changes that may affect emissions any time during the engine's lifetime.

(3) Modify an FEL or FCL for an engine family as described in paragraph (f) of this section.

(b) To amend your application for certification, send the relevant information to the Designated Compliance Officer.

(1) Describe in detail the addition or change in the engine model or configuration you intend to make.

(2) Include engineering evaluations or data showing that the amended engine family complies with all applicable requirements. You may do this by showing that the original emission-data engine is still appropriate for showing that the amended family complies with all applicable requirements.

(3) If the original emission-data engine for the engine family is not appropriate to show compliance for the new or modified engine configuration, include new test data showing that the new or modified engine configuration meets the requirements of this part.

(4) Include any other information needed to make your application correct and complete.

(c) We may ask for more test data or engineering evaluations. You must give us these within 30 days after we request them.

(d) For engine families already covered by a certificate of conformity, we will determine whether the existing certificate of conformity covers your newly added or modified engine. You may ask for a hearing if we deny your request (see § 1036.820).

(e) The amended application applies starting with the date you submit the amended application, as follows:

(1) For engine families already covered by a certificate of conformity, you may start producing a new or modified engine configuration any time after you send us your amended application and before we make a decision under paragraph (d) of this section. However, if we determine that the affected engines do not meet applicable requirements in this part, we will notify you to cease production of the engines and may require you to recall the engines at no expense to the owner. Choosing to produce engines under this paragraph (e) is deemed to be consent to recall all engines that we determine do not meet applicable emission standards or other requirements in this part and to remedy the nonconformity at no expense to the owner. If you do not provide information required under paragraph (c) of this section within 30 days after we request it, you must stop producing the new or modified engines.

(2) [Reserved]

(f) You may ask us to approve a change to your FEL in certain cases after the start of production, but before the end of the model year. If you change an FEL for CO<sub>2</sub>, your FCL for CO<sub>2</sub> is automatically set to your new FEL divided by 1.03. The changed FEL may not apply to engines you have already introduced into U.S. commerce, except as described in this paragraph (f). You may ask us to approve a change to your FEL in the following cases:

(1) You may ask to raise your FEL for your engine family at any time. In your request, you must show that you will still be able to meet the emission standards as specified in subparts B and H of this part. Use the appropriate FELs/FCLs with corresponding production volumes to calculate emission credits for the model year, as described in subpart H of this part.

(2) You may ask to lower the FEL for your engine family only if you have test data from production engines showing that emissions are below the proposed

lower FEL (or below the proposed FCL for CO<sub>2</sub>). The lower FEL/FCL applies only to engines you produce after we approve the new FEL/FCL. Use the appropriate FEL/FCL with corresponding production volumes to calculate emission credits for the model year, as described in subpart H of this part.

(g) You may produce engines or modify in-use engines as described in your amended application for certification and consider those engines to be in a certified configuration. Modifying a new or in-use engine to be in a certified configuration does not violate the tampering prohibition of 40 CFR 1068.101(b)(1), as long as this does not involve changing to a certified configuration with a higher family emission limit.

#### § 1036.230 Selecting engine families.

(a) For purposes of certification to the standards of this part, divide your product line into families of engines that are expected to have similar characteristics for criteria emissions throughout the useful life as described in this section. Your engine family is limited to a single model year.

(b) Group engines in the same engine family if they are the same in all the following design aspects:

(1) The combustion cycle and fuel. See paragraph (g) of this section for special provisions that apply for dual-fuel and flexible-fuel engines.

(2) The cooling system (water-cooled vs. air-cooled).

(3) Method of air aspiration, including the location of intake and exhaust valves or ports and the method of intake-air cooling, if applicable.

(4) The arrangement and composition of catalytic converters and other aftertreatment devices.

(5) Cylinder arrangement (such as in-line vs. vee configurations) and bore center-to-center dimensions.

(6) Method of control for engine operation other than governing (*i.e.*, mechanical or electronic).

(7) The numerical level of the applicable criteria emission standards. For example, an engine family may not include engines certified to different family emission limits for criteria emission standards, though you may change family emission limits without recertifying as specified in § 1036.225(f).

(c) You may subdivide a group of engines that is identical under paragraph (b) of this section into different engine families if you show the expected criteria emission characteristics are different during the useful life.

(d) In unusual circumstances, you may group engines that are not identical with respect to the design aspects listed in paragraph (b) of this section in the same engine family if you show that their criteria emission characteristics during the useful life will be similar.

(e) Engine configurations certified as hybrid engines or hybrid powertrains may not be included in an engine family with engines that have nonhybrid powertrains. Note that this does not prevent you from including engines in a nonhybrid family if they are used in hybrid vehicles, as long as you certify them based on engine testing.

(f) You must certify your engines to the greenhouse gas standards of § 1036.108 using the same engine families you use for criteria pollutants. The following additional provisions apply with respect to demonstrating compliance with the standards in § 1036.108:

(1) You may subdivide an engine family into subfamilies that have a different FCL for CO<sub>2</sub> emissions. These subfamilies do not apply for demonstrating compliance with criteria standards in § 1036.104.

(2) If you certify engines in the family for use as both vocational and tractor engines, you must split your family into two separate subfamilies.

(i) Calculate emission credits relative to the vocational engine standard for the number of engines sold into vocational applications and relative to the tractor engine standard for the number of engines sold into non-vocational tractor applications. You may assign the numbers and configurations of engines within the respective subfamilies at any time before submitting the report required by § 1036.730. If the family participates in averaging, banking, or trading, you must identify the type of vehicle in which each engine is installed; we may alternatively allow you to use statistical methods to determine this for a fraction of your engines. Keep records to document this determination.

(ii) If you restrict use of the test configuration for your split family only to tractors, or only to vocational vehicles, you must identify a second testable configuration for the other type of vehicle (or an unrestricted configuration). Identify this configuration in your application for certification. The FCL for the engine family applies for this configuration as well as the primary test configuration.

(3) If you certify both engine fuel maps and powertrain fuel maps for an engine family, you may split the engine family into two separate subfamilies. Indicate this in your application for

certification, and identify whether one or both of these sets of fuel maps applies for each group of engines. If you do not split your family, all engines within the family must conform to the engine fuel maps, including any engines for which the powertrain maps also apply.

(4) If you certify in separate engine families engines that could have been certified in vocational and tractor engine subfamilies in the same engine family, count the two families as one family for purposes of determining your obligations with respect to the OBD requirements and in-use testing requirements. Indicate in the applications for certification that the two engine families are covered by this paragraph (f)(4).

(5) Except as described in this paragraph (f), engine configurations within an engine family must use equivalent greenhouse gas emission controls. Unless we approve it, you may not produce nontested configurations without the same emission control hardware included on the tested configuration. We will only approve it if you demonstrate that the exclusion of the hardware does not increase greenhouse gas emissions.

(g) You may certify dual-fuel or flexible-fuel engines in a single engine family. You may include dedicated-fuel versions of this same engine model in the same engine family, as long as they are identical to the engine configuration with respect to that fuel type for the dual-fuel or flexible-fuel version of the engine. For example, if you produce an engine that can alternately run on gasoline and natural gas, you can include the gasoline-only and natural gas-only versions of the engine in the same engine family as the dual-fuel engine if engine operation on each fuel type is identical with or without installation of components for operating on the other fuel.

#### § 1036.235 Testing requirements for certification.

This section describes the emission testing you must perform to show compliance with the emission standards in §§ 1036.104 and 1036.108.

(a) Select and configure one or two emission-data engines from each engine family as follows:

(1) You may use one engine for criteria pollutant testing and a different engine for greenhouse gas emission testing, or you may use the same engine for all testing.

(2) For criteria pollutant emission testing, select the engine configuration with the highest volume of fuel injected per cylinder per combustion cycle at the point of maximum torque—unless good

engineering judgment indicates that a different engine configuration is more likely to exceed (or have emissions nearer to) an applicable emission standard or FEL. If two or more engines have the same fueling rate at maximum torque, select the one with the highest fueling rate at rated speed. In making this selection, consider all factors expected to affect emission-control performance and compliance with the standards, including emission levels of all exhaust constituents, especially NO<sub>x</sub> and PM. To the extent we allow it for establishing deterioration factors, select for testing those engine components or subsystems whose deterioration best represents the deterioration of in-use engines.

(3) For greenhouse gas emission testing, the standards of this part apply only with respect to emissions measured from the tested configuration and other configurations identified in § 1036.205(l)(2). Note that configurations identified in § 1036.205(l)(2) are considered to be “tested configurations” whether or not you test them for certification. However, you must apply the same (or equivalent) emission controls to all other engine configurations in the engine family. In other contexts, the tested configuration is sometimes referred to as the “parent configuration”, although the terms are not synonymous.

(b) Test your emission-data engines using the procedures and equipment specified in subpart F of this part. In the case of dual-fuel and flexible-fuel engines, measure emissions when operating with each type of fuel for which you intend to certify the engine.

(1) For criteria pollutant emission testing, measure NO<sub>x</sub>, PM, CO, and NMHC emissions using each duty cycle specified in § 1036.104.

(2) For greenhouse gas emission testing, measure CO<sub>2</sub>, CH<sub>4</sub>, and N<sub>2</sub>O emissions; the following provisions apply regarding test cycles for demonstrating compliance with tractor and vocational standards:

(i) If you are certifying the engine for use in tractors, you must measure CO<sub>2</sub> emissions using the SET duty cycle specified in § 1036.510, taking into account the interim provisions in § 1036.150(s), and measure CH<sub>4</sub> and N<sub>2</sub>O emissions using the FTP transient cycle.

(ii) If you are certifying the engine for use in vocational applications, you must measure CO<sub>2</sub>, CH<sub>4</sub>, and N<sub>2</sub>O emissions

using the appropriate FTP transient duty cycle, including cold-start and hot-start testing as specified in § 1036.512.

(iii) You may certify your engine family for both tractor and vocational use by submitting CO<sub>2</sub> emission data and specifying FCLs for both SET and FTP transient duty cycles.

(iv) Some of your engines certified for use in tractors may also be used in vocational vehicles, and some of your engines certified for use in vocational may be used in tractors. However, you may not knowingly circumvent the intent of this part (to reduce in-use emissions of CO<sub>2</sub>) by certifying engines designed for tractors or vocational vehicles (and rarely used in the other application) to the wrong cycle. For example, we would generally not allow you to certify all your engines to the SET duty cycle without certifying any to the FTP transient cycle.

(c) We may perform confirmatory testing by measuring emissions from any of your emission-data engines. If your certification includes powertrain testing as specified in § 1036.630, this paragraph (c) also applies for the powertrain test results.

(1) We may decide to do the testing at your plant or any other facility. If we do this, you must deliver the engine to a test facility we designate. The engine you provide must include appropriate manifolds, aftertreatment devices, ECMs, and other emission-related components not normally attached directly to the engine block. If we do the testing at your plant, you must schedule it as soon as possible and make available the instruments, personnel, and equipment we need.

(2) If we measure emissions on your engine, the results of that testing become the official emission results for the engine as specified in this paragraph (c). Unless we later invalidate these data, we may decide not to consider your data in determining if your engine family meets applicable requirements in this part.

(3) Before we test one of your engines, we may set its adjustable parameters to any point within the practically adjustable ranges (see § 1036.115(f)).

(4) Before we test one of your engines, we may calibrate it within normal production tolerances for anything we do not consider an adjustable parameter. For example, we may calibrate it within normal production tolerances for an engine parameter that is subject to production variability because it is

adjustable during production, but is not considered an adjustable parameter because it is permanently sealed. For parameters that relate to a level of performance that is itself subject to a specified range (such as maximum power output), we will generally perform any calibration under this paragraph (c)(4) in a way that keeps performance within the specified range.

(5) For greenhouse gas emission testing, we may use our emission test results for steady-state, idle, cycle-average and powertrain fuel maps defined in § 1036.505(b) as the official emission results. We will not replace individual points from your fuel map.

(i) We will determine fuel masses,  $m_{\text{fuel}[\text{cycle}]}$ , and mean idle fuel mass flow rates,  $\bar{m}_{\text{fuel}[\text{idle}]}$ , if applicable, using both direct and indirect measurement. We will determine the result for each test point based on carbon balance error verification as described in § 1036.535(g)(3)(i) and (ii).

(ii) We will perform this comparison using the weighted results from GEM, using vehicles that are appropriate for the engine under test. For example, we may select vehicles that the engine went into for the previous model year.

(iii) If you supply cycle-average engine fuel maps for the highway cruise cycles instead of generating a steady-state fuel map for these cycles, we may perform a confirmatory test of your engine fuel maps for the highway cruise cycles by either of the following methods:

(A) Directly measuring the highway cruise cycle-average fuel maps.

(B) Measuring a steady-state fuel map as described in this paragraph (c)(5) and using it in GEM to create our own cycle-average engine fuel maps for the highway cruise cycles.

(iv) We will replace fuel maps as a result of confirmatory testing as follows:

(A) Weight individual duty cycle results using the vehicle categories determined in paragraph (c)(5)(i) of this section and respective weighting factors in 40 CFR 1037.510(c) to determine a composite CO<sub>2</sub> emission value for each vehicle configuration; then repeat the process for all the unique vehicle configurations used to generate the manufacturer's fuel maps.

(B) The average percent difference between fuel maps is calculated using the following equation:

$$\text{difference} = \left( \frac{\sum_{i=1}^N \frac{e_{\text{CO2compEPA}i} - e_{\text{CO2compManu}i}}{e_{\text{CO2compManu}i}}}{N} \right) \cdot 100 \%$$

Eq. 1036.235-1

Where:

$i$  = an indexing variable that represents one individual weighted duty cycle result for a vehicle configuration.

$N$  = total number of vehicle configurations.

$e_{\text{CO2compEPA}i}$  = unrounded composite mass of CO<sub>2</sub> emissions in g/ton-mile for vehicle configuration  $i$  for the EPA test.

$e_{\text{CO2compManu}i}$  = unrounded composite mass of CO<sub>2</sub> emissions in g/ton-mile for vehicle configuration  $i$  for the manufacturer-declared map.

(C) Where the unrounded average percent difference between our composite weighted fuel map and the manufacturer's is at or below 0%, we will not replace the manufacturer's maps, and we will consider an individual engine to have passed the fuel map.

(6) We may perform confirmatory testing with an engine dynamometer to simulate normal engine operation to determine whether your emission-data engine meets off-cycle emission standards. The accuracy margins described in § 1036.420(a) do not apply for such laboratory testing.

(d) You may ask to use carryover emission data from a previous model year instead of doing new tests, but only if all the following are true:

(1) The engine family from the previous model year differs from the current engine family only with respect to model year, items identified in § 1036.225(a), or other characteristics unrelated to emissions. We may waive this criterion for differences we determine not to be relevant.

(2) The emission-data engine from the previous model year remains the appropriate emission-data engine under paragraph (a) of this section.

(3) The data show that the emission-data engine would meet all the requirements that apply to the engine family covered by the application for certification.

(e) We may require you to test a second engine of the same configuration in addition to the engines tested under paragraph (a) of this section.

(f) If you use an alternate test procedure under 40 CFR 1065.10 and later testing shows that such testing does not produce results that are equivalent to the procedures specified in subpart F of this part, we may reject data you generated using the alternate procedure.

(g) We may evaluate or test your engines to determine whether they have a defeat device before or after we issue a certificate of conformity. We may test or require testing on any vehicle or engine at a designated location, using driving cycles and conditions that may reasonably be expected in normal operation and use to investigate a potential defeat device. If we designate an engine's AECD as a possible defeat device, you must demonstrate to us that that the AECD does not reduce emission control effectiveness when the engine operates under conditions that may reasonably be expected in normal operation and use, unless one of the specific exceptions described in § 1036.115(h) applies.

#### **§ 1036.240 Demonstrating compliance with criteria pollutant emission standards.**

(a) For purposes of certification, your engine family is considered in compliance with the duty-cycle emission standards in § 1036.104(a)(1) and (2) if all emission-data engines representing that family have test results showing official emission results and deteriorated emission levels at or below these standards (including all corrections and adjustments). This also applies for all test points for emission-data engines within the family used to establish deterioration factors. Note that your FELs are considered to be the applicable emission standards with which you must comply if you participate in the ABT program in subpart H of this part. Use good engineering judgment to demonstrate compliance with off-cycle standards throughout the useful life.

(b) Your engine family is deemed not to comply if any emission-data engine representing that family has test results showing an official emission result or a deteriorated emission level for any pollutant that is above an applicable emission standard (including all corrections and adjustments). Similarly, your engine family is deemed not to comply if any emission-data engine representing that family has test results showing any emission level above the applicable off-cycle emission standard for any pollutant. This also applies for all test points for emission-data engines within the family used to establish deterioration factors.

(c) To compare emission levels from the emission-data engine with the applicable duty-cycle emission standards, apply deterioration factors to the measured emission levels for each pollutant. Section 1036.245 specifies how to test engines and engine components to develop deterioration factors that represent the deterioration expected in emissions over your engines' useful life. Section 1036.246 describes how to confirm or modify deterioration factors based on in-use verification testing. Your deterioration factors must take into account any available data from other in-use testing with similar engines. Small manufacturers may use assigned deterioration factors that we establish. Apply deterioration factors as follows:

(1) *Additive deterioration factor for exhaust emissions.* Except as specified in paragraph (c)(2) of this section, use an additive deterioration factor for exhaust emissions. An additive deterioration factor is the difference between exhaust emissions at the end of the useful life and exhaust emissions at the low-hour test point. In these cases, adjust the official emission results for each tested engine at the selected test point by adding the factor to the measured emissions. If the factor is less than zero, use zero. Additive deterioration factors must be specified to one more decimal place than the applicable standard.

(2) *Multiplicative deterioration factor for exhaust emissions.* Use a multiplicative deterioration factor if good engineering judgment calls for the deterioration factor for a pollutant to be the ratio of exhaust emissions at the end of the useful life to exhaust emissions at the low-hour test point. For example, if you use aftertreatment technology that controls emissions of a pollutant proportionally to engine-out emissions, it is often appropriate to use a multiplicative deterioration factor. Adjust the official emission results for each tested engine at the selected test point by multiplying the measured emissions by the deterioration factor. If the factor is less than one, use one. A multiplicative deterioration factor may not be appropriate in cases where testing variability is significantly greater than engine-to-engine variability. Multiplicative deterioration factors must

be specified to one more significant figure than the applicable standard.

(3) *Sawtooth and other nonlinear deterioration patterns.* The deterioration factors described in paragraphs (c)(1) and (2) of this section assume that the highest useful life emissions occur either at the end of useful life or at the low-hour test point. The provisions of this paragraph (c)(3) apply where good engineering judgment indicates that the highest useful life emissions will occur between these two points. For example, emissions may increase with service accumulation until a certain maintenance step is performed, then return to the low-hour emission levels and begin increasing again. Such a pattern may occur with battery-based electric hybrid engines. Base deterioration factors for engines with such emission patterns on the difference between (or ratio of) the point at which the highest emissions occur and the low-hour test point. Note that this applies for maintenance-related deterioration only where we allow such critical emission-related maintenance.

(4) *Dual-fuel and flexible-fuel engines.* In the case of dual-fuel and flexible-fuel engines, apply deterioration factors separately for each fuel type. You may accumulate service hours on a single emission-data engine using the type of fuel or the fuel mixture expected to have the highest combustion and exhaust temperatures; you may ask us to approve a different fuel mixture if you demonstrate that a different criterion is more appropriate.

(5) *Deterioration factor for crankcase emissions.* If engines route crankcase emissions into the ambient atmosphere or into the exhaust downstream of exhaust aftertreatment, you must account for any increase in crankcase emissions throughout the useful life using good engineering judgment. Use separate deterioration factors for crankcase emissions of each pollutant (either multiplicative or additive).

(d) Determine the official emission result for each pollutant to at least one more decimal place than the applicable standard. Apply the deterioration factor to the official emission result, as described in paragraph (c) of this section, then round the adjusted figure to the same number of decimal places as the emission standard. Compare the rounded emission levels to the emission standard for each emission-data engine.

(e) You do not need deterioration factors to demonstrate compliance with off-cycle standards. However, for engines designed to discharge crankcase emissions to the ambient atmosphere, you must determine deteriorated emission levels to represent crankcase

emissions at the end of useful life for purposes of demonstrating compliance with off-cycle emission standards. Determine an official brake-specific crankcase emission result for each pollutant based on operation over the FTP duty cycle. Also determine an official crankcase emission result for NO<sub>x</sub> in g/hr from the idle portion of any of the duty cycles specified in subpart F of this part. Apply crankcase deterioration factors to all these official crankcase emission results as described in paragraph (c) of this section, then round the adjusted figures to the same number of decimal places as the off-cycle emission standards in § 1036.104(a)(3).

#### **§ 1036.241 Demonstrating compliance with greenhouse gas emission standards.**

(a) For purposes of certification, your engine family is considered in compliance with the emission standards in § 1036.108 if all emission-data engines representing the tested configuration of that engine family have test results showing official emission results and deteriorated emission levels at or below the standards. Note that your FCLs are considered to be the applicable emission standards with which you must comply for certification.

(b) Your engine family is deemed not to comply if any emission-data engine representing the tested configuration of that engine family has test results showing an official emission result or a deteriorated emission level for any pollutant that is above an applicable emission standard (generally the FCL). Note that you may increase your FCL if any certification test results exceed your initial FCL.

(c) Apply deterioration factors to the measured emission levels for each pollutant to show compliance with the applicable emission standards. Your deterioration factors must take into account any available data from in-use testing with similar engines. Apply deterioration factors as follows:

(1) *Additive deterioration factor for greenhouse gas emissions.* Except as specified in paragraphs (c)(2) and (3) of this section, use an additive deterioration factor for exhaust emissions. An additive deterioration factor is the difference between the highest exhaust emissions (typically at the end of the useful life) and exhaust emissions at the low-hour test point. In these cases, adjust the official emission results for each tested engine at the selected test point by adding the factor to the measured emissions. If the factor is less than zero, use zero. Additive deterioration factors must be specified

to one more decimal place than the applicable standard.

(2) *Multiplicative deterioration factor for greenhouse gas emissions.* Use a multiplicative deterioration factor for a pollutant if good engineering judgment calls for the deterioration factor for that pollutant to be the ratio of the highest exhaust emissions (typically at the end of the useful life) to exhaust emissions at the low-hour test point. Adjust the official emission results for each tested engine at the selected test point by multiplying the measured emissions by the deterioration factor. If the factor is less than one, use one. A multiplicative deterioration factor may not be appropriate in cases where testing variability is significantly greater than engine-to-engine variability. Multiplicative deterioration factors must be specified to one more significant figure than the applicable standard.

(3) *Sawtooth and other nonlinear deterioration patterns.* The deterioration factors described in paragraphs (c)(1) and (2) of this section assume that the highest useful life emissions occur either at the end of useful life or at the low-hour test point. The provisions of this paragraph (c)(3) apply where good engineering judgment indicates that the highest useful life emissions will occur between these two points. For example, emissions may increase with service accumulation until a certain maintenance step is performed, then return to the low-hour emission levels and begin increasing again. Such a pattern may occur with battery-based electric hybrid engines. Base deterioration factors for engines with such emission patterns on the difference between (or ratio of) the point at which the highest emissions occur and the low-hour test point. Note that this applies for maintenance-related deterioration only where we allow such critical emission-related maintenance.

(4) *Dual-fuel and flexible-fuel engines.* In the case of dual-fuel and flexible-fuel engines, apply deterioration factors separately for each fuel type by measuring emissions with each fuel type at each test point. You may accumulate service hours on a single emission-data engine using the type of fuel or the fuel mixture expected to have the highest combustion and exhaust temperatures; you may ask us to approve a different fuel mixture if you demonstrate that a different criterion is more appropriate.

(d) Calculate emission data using measurements to at least one more decimal place than the applicable standard. Apply the deterioration factor to the official emission result, as described in paragraph (c) of this

section, then round the adjusted figure to the same number of decimal places as the emission standard. Compare the rounded emission levels to the emission standard for each emission-data engine.

(e) If you identify more than one configuration in § 1036.205(l)(2), we may test (or require you to test) any of the identified configurations. We may also require you to provide an engineering analysis that demonstrates that untested configurations listed in § 1036.205(l)(2) comply with their FCL.

**§ 1036.245 Deterioration factors for exhaust emission standards.**

This section describes how to determine deterioration factors, either with pre-existing test data or with new emission measurements. Apply these deterioration factors to determine whether your engines will meet the duty-cycle emission standards throughout the useful life as described in § 1036.240. The provisions of this section and the verification provisions of § 1036.246 apply for all engine families starting in model year 2027; you may optionally use these provisions to determine and verify deterioration factors for earlier model years.

(a) You may ask us to approve deterioration factors for an engine family based on an engineering analysis of emission measurements from similar highway or nonroad engines if you have already given us these data for certifying the other engines in the same or earlier model years. Use good engineering judgment to decide whether the two engines are similar. We will approve your request if you show us that the emission measurements from other engines reasonably represent in-use deterioration for the engine family for which you have not yet determined deterioration factors.

(b) [Reserved]

(c) If you are unable to determine deterioration factors for an engine family under paragraph (a) of this section, select engines, subsystems, or components for testing. Determine deterioration factors based on service accumulation and related testing to represent the deterioration expected from in-use engines over the useful life, including crankcase emissions. You may perform maintenance on emission-data engines as described in § 1036.125 and 40 CFR part 1065, subpart E. Use good engineering judgment for all aspects of the effort to establish deterioration factors under this paragraph (c). Send us your test plan for our preliminary approval under § 1036.210. You may apply deterioration factors based on testing under this paragraph (c) to multiple engine

families, consistent with the provisions in paragraph (a) of this section. Determine deterioration factors based on a combination of minimum required engine dynamometer aging hours and accelerated bench-aged aftertreatment as follows:

(1) Select an emission-data engine and aftertreatment devices and systems that can be assembled into a certified configuration to represent the engine family. Stabilize the engine and aftertreatment devices and systems, together or separately, to prepare for emission measurements. Perform low-hour emission measurement once the engine has operated with aftertreatment long enough to stabilize the emission control. Measure emissions of all regulated pollutants while the engine operates over all applicable duty cycles on an engine dynamometer as described in subpart F of this part.

(2) Perform additional service accumulation as described in paragraph (c)(3) of this section on an engine dynamometer meeting at least the following minimum specifications:

TABLE 1 TO PARAGRAPH (c)(2) OF § 1036.245—MINIMUM REQUIRED ENGINE DYNAMOMETER AGING HOURS BY PRIMARY INTENDED SERVICE CLASS

Primary intended service class	Minimum engine dynamometer hours
Spark-ignition HDE .....	300
Light HDE .....	1,250
Medium HDE .....	1,500
Heavy HDE .....	1,500

(3) Perform service accumulation in the laboratory by operating the engine repeatedly over one of the following test sequences, or a different test sequence that we approve in advance:

(i) Use duty-cycle sequence 1 for operating any engine on an engine dynamometer, as follows:

- (A) Operate at idle for 2 hours.
- (B) Operate for 105 ± 1 hours over a repeat sequence of one FTP followed by one RMC.
- (C) Operate over one LLC.
- (D) Operate at idle for 2 hours.
- (E) Shut down the engine for cooldown to ambient temperature.

(ii) Duty-cycle sequence 2 is based on operating over the LLC and the vehicle-based duty cycles from 40 CFR part 1037. Select the vehicle subcategory and vehicle configuration from § 1036.540 with the highest reference cycle work for each vehicle-based duty cycle. Operate the engine as follows for duty-cycle sequence 2:

- (A) Operate at idle for 2 hours.
- (B) Operate for 105 ± 1 hours over a repeat sequence of one Heavy-duty Transient Test Cycle, then one 55 mi/hr highway cruise cycle, and then one 65 mi/hr highway cruise cycle.
- (C) Operate over one LLC.
- (D) Operate at idle for 2 hours.
- (E) Shut down the engine for cooldown to ambient temperature.

(4) Perform all the emission measurements described in paragraph (c)(1) of this section when the engine has reached the minimum service accumulation specified in paragraph (c)(2) of this section, and again after you finish service accumulation in the laboratory if your service accumulation exceeds the values specified in paragraph (c)(2) of this section.

(5) Determine the deterioration factor based on a combination of actual and simulated service accumulation represented by a number of hours of engine operation calculated using the following equation:

$$t_{\text{total}} = \frac{UL \cdot k}{\bar{v}_{\text{agingcycle}}}$$

Eq. 1036.245-1

Where:

UL = useful life mileage from § 1036.104(e).  
 k = 1.15 for Heavy HDE and 1.0 for all other primary intended service classes.

$\bar{v}_{\text{agingcycle}}$  = average speed of aging cycle in paragraph (c)(3) of this section. Use 40.26 mi/hr for duty-cycle sequence 1 and 44.48 mi/hr for duty-cycle sequence 2.

*Example for Heavy HDE for Duty-Cycle Sequence 1:*

UL = 650,000 miles  
 k = 1.15

$\bar{v}_{\text{agingcycle}}$  = 40.26 mi/hr

$$t_{\text{total}} = \frac{650,000 \cdot 1.15}{40.26}$$

$t_{\text{total}} = 18,567$  hr

(6) Perform accelerated bench aging of aftertreatment devices to represent normal engine operation over the useful life using the service accumulation hours determined in paragraph (c)(5) of this section. Design your bench aging to represent 10,000 hours of in-use engine operation for every 1,000 hours of accelerated bench aging. Use the accelerated bench-aging procedure in 40 CFR 1065.1131 through 1065.1145 or get our advance approval to use a different procedure that adequately that accounts for thermal and chemical degradation. For example, this might involve testing consistent with the analogous procedures that apply for light-duty vehicles under 40 CFR part 86, subpart S.

(7) After bench-aging aftertreatment devices, install or reinstall those aftertreatment devices and systems on an emission-data engine (or an equivalent engine) that has been stabilized without aftertreatment. Ensure that the aftertreatment is installed such that the engine is in a certified configuration to represent the engine family.

(8) Operate the engine with the bench-aged aftertreatment devices to stabilize emission controls for at least 100 hours on an engine dynamometer.

(9) Once stabilization is complete, repeat the low-hour emission measurements.

(10) Calculate deterioration factors by comparing exhaust emissions with the bench-aged aftertreatment and exhaust emissions at the low-hour test point. Create a linear curve fit if testing includes intermediate test points. Calculate deterioration factors based on measured values, without extrapolation.

(d) If you determine deterioration factors as described in paragraph (c) of this section, you may apply those deterioration factors in later years for engine families that qualify for carryover certification as described in § 1036.235(d). You may also apply those deterioration factors for additional engine families as described in paragraph (a) of this section.

(e) Include the following information in your application for certification:

(1) If you use test data from a different engine family, explain why this is appropriate and include all the emission measurements on which you base the deterioration factors. If the deterioration factors for the new engine family are not identical to the deterioration factors for the different engine family, describe your engineering analysis to justify the revised values and state that all your data, analyses, evaluations, and other information are available for our review upon request.

(2) If you determined deterioration factors under paragraph (c) of this section, include the following information in the first year that you use those deterioration factors:

(i) Describe your accelerated bench aging or other procedures to represent full-life service accumulation for the engine's emission controls.

(ii) Describe how you prepared the test engine before and after installing aftertreatment systems to determine deterioration factors.

(iii) Identify the power rating of the emission-data engine used to determine deterioration factors.

#### § 1036.246 Verifying deterioration factors.

We may require you to test in-use engines as described in this section to verify that the deterioration factors you determined under § 1036.245 are appropriate.

(a) Select and prepare in-use engines representing the engine family we identify for verification testing under this section as follows:

(1) You may recruit candidate engines any time before testing. This may involve creating a pool of candidate engines and vehicles in coordination with vehicle manufacturers and vehicle purchasers to ensure availability and to confirm a history of proper maintenance. You may meet the testing requirements of this section by repeating tests on a given engine as it ages, or you may test different engines over the course of verification testing; however, you may not choose whether to repeat tests on a given engine at a later stage based on its measured emission levels. We generally require that you describe your plan for selecting engines in advance and justify any departures from that plan.

(2) Selected vehicles must come from independent sources, unless we approve your request to select vehicles that you own or manage. In your request, you must describe how you will ensure that the vehicle operator will drive in a way that represents normal in-use operation for the engine family.

(3) Select vehicles with installed engines from the same engine family and with the same power rating as the emission-data engine used to determine the deterioration factors. However, if the test engine does not have the specified power rating, you may ask for our approval to either test in the as-received condition or modify engines in selected vehicles by reflashing the ECM or replacing parts to change the engines to be in a different certified configuration for proper testing.

(4) Selected engines must meet the screening criteria described in § 1036.410(b)(2) through (4). Selected engines must also have their original aftertreatment components and be in a certified configuration. You may ask us to approve replacing a critical emission-related component with an equivalent part that has undergone a comparable degree of aging.

(5) We may direct you to preferentially select certain types of vehicles, vehicles from certain model years, or vehicles within some range of service accumulation. We will not direct you to select vehicles that are 10 or more years old, or vehicles with an odometer reading exceeding 85 percent of the engine's useful life. We will

specify a time frame for completing required testing.

(b) Perform verification testing with one of the following procedures, or with an alternative procedure that you demonstrate to be equally effective:

(1) *Engine dynamometer testing.* Measure emissions from engines equipped with in-use aftertreatment systems on an engine dynamometer as follows:

(i) Test the aftertreatment system from at least two engines using the procedures specified in subpart F of this part and 40 CFR part 1065. Install the aftertreatment system from the selected in-use vehicle, including all associated wiring, sensors, and related hardware and software, on one of the following partially complete engines:

(A) The in-use engine from the same vehicle.

(B) The emission-data engine used to determine the deterioration factors.

(C) A different emission-data engine from the same engine family that has been stabilized as described in 40 CFR 1065.405(c).

(ii) Perform testing on all certification duty cycles with brake-specific emission standards (g/hp-hr) to determine whether the engine meets all the duty-cycle emission standards, including any compliance allowance, for criteria pollutants. Apply infrequent regeneration adjustment factors as included in your application for certification or develop new factors if we request it.

(iii) Evaluate verification testing for each pollutant independently. You pass the verification test if at least 70 percent of tested engines meet standards for each pollutant over all duty cycles. You fail the verification test if fewer than 70 percent of engines meet standards for a given pollutant over all duty cycles.

(2) *PEMS testing.* Measure emissions using PEMS with in-use engines that remain installed in selected vehicles as follows:

(i) Test at least five engines using the procedures specified in § 1036.555 and 40 CFR part 1065, subpart J.

(ii) Measure emissions of NO<sub>x</sub>, HC, and CO as the test vehicle's normal operator drives over a regular shift-day to determine whether the engine meets all the off-cycle emission standards that applied for the engine's original certification. Apply infrequent regeneration adjustment factors as included in your application for certification. For Spark-ignition HDE, calculate off-cycle emission standards for purposes of this subpart by multiplying the FTP duty-cycle standards in § 1036.104(a) by 1.5 and



rounding to the same number of decimal places.

(iii) Evaluate verification testing for each pollutant independently. You pass the verification test if at least 70 percent of tested engines meet the off-cycle standards including any compliance allowance and accuracy margin, for each pollutant. You fail the verification test if fewer than 70 percent of tested engines do not meet standards for a given pollutant.

(iv) You may reverse a fail determination under paragraph (b)(2)(iii) of this section by restarting and successfully completing the verification test for that year using the procedures specified in paragraph (b)(1) of this section. If you do this, you must use the verification testing procedures specified in paragraph (b)(1) of this section for all remaining verification testing for the engine family.

(c) You may stop testing under the verification test program and concede a fail result before you meet all the testing requirements of this section.

(d) Prepare a report to describe your verification testing each year. Include at least the following information:

(1) Identify whether you tested using the procedures specified in paragraph (b)(1) or (2) of this section.

(2) Describe how the test results support a pass or fail decision for the verification test. For in-field measurements, include continuous 1 Hz data collected over the shift-day and binned emission values determined under § 1036.530.

(3) If your testing included invalid test results, describe the reasons for invalidating the data. Give us the invalid test results if we ask for them.

(4) Describe the types of vehicles selected for testing. If you determined that any selected vehicles with enough mileage accumulation were not suitable for testing, describe why you chose not to test them.

(5) For each tested engine, identify the vehicle's VIN, the engine's serial number, the engine's power rating, and the odometer reading and the engine's lifetime operating hours at the start of testing (or engine removal).

(6) State that the tested engines have been properly maintained and used and describe any noteworthy aspects of each vehicle's maintenance history. Describe the steps you took to prepare the engines for testing.

(7) For testing with engines that remain installed in vehicles, identify the date and location of testing. Also describe the ambient conditions and the driving route over the course of the shift-day.

(e) Send electronic reports to the Designated Compliance Officer using an approved information format. If you want to use a different format, send us a written request with justification.

(1) You may send us reports as you complete testing for an engine instead of waiting until you complete testing for all engines.

(2) We may ask you to send us less information in your reports than we specify in this section.

(3) We may require you to send us more information to evaluate whether your engine family meets the requirements of this part.

(4) Once you send us information under this section, you need not send that information again in later reports.

(5) We will review your test report to evaluate the results of the verification testing at each stage. We will notify you if we disagree with your conclusions, if we need additional information, or if you need to revise your testing plan for future testing.

#### **§ 1036.250 Reporting and recordkeeping for certification.**

(a) By September 30 following the end of the model year, send the Designated Compliance Officer a report including the total nationwide production volume of engines you produced in each engine family during the model year (based on information available at the time of the report). Report the production by serial number and engine configuration. You may combine this report with reports required under subpart H of this part. We may waive the reporting requirements of this paragraph (a) for small manufacturers.

(b) Organize and maintain the following records:

(1) A copy of all applications and any summary information you send us.

(2) Any of the information we specify in § 1036.205 that you were not required to include in your application.

(3) A detailed history of each emission-data engine. For each engine, describe all of the following:

(i) The emission-data engine's construction, including its origin and buildup, steps you took to ensure that it represents production engines, any components you built specially for it, and all the components you include in your application for certification.

(ii) How you accumulated engine operating hours (service accumulation), including the dates and the number of hours accumulated.

(iii) All maintenance, including modifications, parts changes, and other service, and the dates and reasons for the maintenance.

(iv) All your emission tests, including documentation on routine and standard

tests, as specified in part 40 CFR part 1065, and the date and purpose of each test.

(v) All tests to diagnose engine or emission control performance, giving the date and time of each and the reasons for the test.

(vi) Any other significant events.

(4) Production figures for each engine family divided by assembly plant.

(5) Engine identification numbers for all the engines you produce under each certificate of conformity.

(c) Keep routine data from emission tests required by this part (such as test cell temperatures and relative humidity readings) for one year after we issue the associated certificate of conformity. Keep all other information specified in this section for eight years after we issue your certificate.

(d) Store these records in any format and on any media, as long as you can promptly send us organized, written records in English if we ask for them. You must keep these records readily available. We may review them at any time.

#### **§ 1036.255 EPA oversight on certificates of conformity.**

(a) If we determine an application is complete and shows that the engine family meets all the requirements of this part and the Act, we will issue a certificate of conformity for the engine family for that model year. We may make the approval subject to additional conditions.

(b) We may deny an application for certification if we determine that an engine family fails to comply with emission standards or other requirements of this part or the Clean Air Act. We will base our decision on all available information. If we deny an application, we will explain why in writing.

(c) In addition, we may deny your application or suspend or revoke a certificate of conformity if you do any of the following:

(1) Refuse to comply with any testing or reporting requirements in this part.

(2) Submit false or incomplete information. This includes doing anything after submitting an application that causes submitted information to be false or incomplete.

(3) Cause any test data to become inaccurate.

(4) Deny us from completing authorized activities (see 40 CFR 1068.20). This includes a failure to provide reasonable assistance.

(5) Produce engines for importation into the United States at a location where local law prohibits us from carrying out authorized activities.

(6) Fail to supply requested information or amend an application to include all engines being produced.

(7) Take any action that otherwise circumvents the intent of the Act or this part.

(d) We may void a certificate of conformity if you fail to keep records, send reports, or give us information as required under this part or the Act. Note that these are also violations of 40 CFR 1068.101(a)(2).

(e) We may void a certificate of conformity if we find that you intentionally submitted false or incomplete information. This includes doing anything after submitting an application that causes submitted information to be false or incomplete after submission.

(f) If we deny an application or suspend, revoke, or void a certificate, you may ask for a hearing (see § 1036.820).

#### **Subpart D—Testing Production Engines and Hybrid Powertrains**

##### **§ 1036.301 Measurements related to GEM inputs in a selective enforcement audit.**

(a) Selective enforcement audits apply for engines as specified in 40 CFR part 1068, subpart E. This section describes how this applies uniquely in certain circumstances.

(b) Selective enforcement audit provisions apply with respect to your fuel maps as follows:

(1) A selective enforcement audit for an engine with respect to fuel maps would consist of performing measurements with production engines to determine fuel-consumption rates as declared for GEM simulations, and running GEM for the vehicle configurations specified in paragraph (b)(2) of this section based on those measured values. The engine is considered passing for a given configuration if the new modeled emission result for each applicable duty cycle is at or below the modeled emission result corresponding to the declared GEM inputs. The engine is considered failing if we determine that its fuel map result is above the modeled emission result corresponding to the result using the manufacturer-declared fuel maps, as specified in § 1036.235(c)(5).

(2) If the audit includes fuel-map testing in conjunction with engine testing relative to exhaust emission standards, the fuel-map simulations for the whole set of vehicles and duty cycles counts as a single test result for purposes of evaluating whether the engine family meets the pass-fail criteria under 40 CFR 1068.420.

(c) If your certification includes powertrain testing as specified in 40 CFR 1036.630, these selective enforcement audit provisions apply with respect to powertrain test results as specified in 40 CFR part 1037, subpart D, and 40 CFR 1037.550. We may allow manufacturers to instead perform the engine-based testing to simulate the powertrain test as specified in 40 CFR 1037.551.

(d) We may suspend or revoke certificates for any appropriate configurations within one or more engine families based on the outcome of a selective enforcement audit.

#### **Subpart E—In-Use Testing**

##### **§ 1036.401 Testing requirements for in-use engines.**

(a) We may perform in-use testing of any engine family subject to the standards of this part, consistent with the Clean Air Act and the provisions of § 1036.235.

(b) This subpart describes a manufacturer-run field-testing program that applies for engines subject to compression-ignition standards under § 1036.104. Note that the testing requirements of 40 CFR part 86, subpart T, continue to apply for engines subject to exhaust emission standards under 40 CFR part 86.

(c) In-use test procedures for engines subject to spark-ignition standards apply as described in § 1036.530. We won't require routine manufacturer-run field testing for Spark-ignition HDE, but the procedures of this subpart describe how to use field-testing procedures to measure emissions from engines installed in vehicles. Use good engineering judgment to apply the measurement procedures for fuels other than gasoline.

(d) We may void your certificate of conformity for an engine family if you do not meet your obligations under this subpart. We may also void individual tests and require you to retest those vehicles or take other appropriate measures in instances where you have not performed the testing in accordance with the requirements described in this subpart.

##### **§ 1036.405 Overview of the manufacturer-run field-testing program.**

(a) You must test in-use engines from the families we select. We may select the following number of engine families for testing, except as specified in paragraph (b) of this section:

(1) We may select up to 25 percent of your engine families in any calendar year, calculated by dividing the number of engine families you certified in the

model year corresponding to the calendar year by four and rounding to the nearest whole number. We will consider only engine families with annual nationwide production volumes above 1,500 units in calculating the number of engine families subject to testing each calendar year under the annual 25 percent engine family limit. If you have only three or fewer families that each exceed an annual nationwide production volume of 1,500 units, we may select one engine family per calendar year for testing.

(2) Over any four-year period, we will not select more than the average number of engine families that you have certified over that four-year period (the model year when the selection is made and the preceding three model years), based on rounding the average value to the nearest whole number.

(3) We will not select engine families for testing under this subpart from a given model year if your total nationwide production volume was less than 100 engines.

(b) If there is clear evidence of a nonconformity with regard to an engine family, we may select that engine family without counting it as a selected engine family under paragraph (a) of this section. For example, there may be clear evidence of a nonconformity if you certify an engine family using carryover data after reaching a fail decision under this subpart in an earlier model year without modifying the engine to remedy the problem.

(c) We may select any individual engine family for testing, regardless of its production volume except as described in paragraph (a)(3) of this section, as long as we do not select more than the number of engine families described in paragraph (a) of this section. We may select an engine family from model year 2027 or any later model year.

(d) You must complete all the required testing and reporting under this subpart (for all ten test engines, if applicable), within 18 months after we receive your proposed plan for recruiting, screening, and selecting vehicles. We will typically select engine families for testing and notify you in writing by June 30 of the applicable calendar year. If you request it, we may allow additional time to send us this information.

(e) If you make a good-faith effort to access enough test vehicles to complete the testing requirements under this subpart for an engine family, but are unable to do so, you must ask us either to modify the testing requirements for the selected engine family or to select a different engine family.

(f) We may select an engine family for repeat testing in a later calendar year. Such a selection for repeat testing would count as an additional engine family for that year under paragraph (a) of this section.

**§ 1036.410 Selecting and screening vehicles and engines for testing.**

(a) Send us your proposed plan for recruiting, screening, and selecting vehicles. Identify the types of vehicles, location, and any other relevant criteria. We will approve your plan if it supports the objective of measuring emissions to represent a broad range of operating characteristics.

(b) Select vehicles and engines for testing that meet the following criteria:

(1) The vehicles come from at least two independent sources.

(2) Powertrain, drivetrain, emission controls, and other key vehicle and engine systems have been properly maintained and used. See § 1036.125.

(3) The engines have not been tampered with, rebuilt, or undergone major repair that could be expected to affect emissions.

(4) The engines have not been misfueled. Do not consider engines misfueled if they have used fuel meeting the specifications of § 1036.415(c).

(5) The vehicles are likely to operate for at least three hours of non-idle operation over a complete shift-day, as described in § 1036.415(f).

(6) The vehicles have not exceeded the applicable useful life, in miles, hours, or years; you may otherwise not exclude engines from testing based on their age or mileage.

(7) The vehicle has appropriate space for safe and proper mounting of the portable emission measurement system (PEMS) equipment.

(c) You must notify us before disqualifying any vehicle based on illuminated MIL or stored OBD trouble codes as described in § 1036.415(b)(2), or for any other reasons not specified in paragraph (b) of this section. For example, notify us if you disqualify any vehicle because the engine does not represent the engine family or the vehicle's usage is atypical for the particular application. You do not need to notify us in advance if the owner declines to participate in the test program.

**§ 1036.415 Preparing and testing engines.**

(a) You must limit maintenance to what is in the owners manual for engines with that amount of service and age. For anything we consider an adjustable parameter (see § 1036.115(f)), you may adjust that parameter only if it is outside its adjustable range. You must

then set the adjustable parameter to your recommended setting or the midpoint of its adjustable range, unless we approve your request to do otherwise. You must get our approval before adjusting anything not considered an adjustable parameter. You must keep records of all maintenance and adjustments, as required by § 1036.435. You must send us these records, as described in § 1036.430(a)(2)(ix), unless we instruct you not to send them.

(b) You may treat a vehicle with an illuminated MIL or stored trouble code as follows:

(1) If a candidate vehicle has an illuminated MIL or stored trouble code, either test the vehicle as received or repair the vehicle before testing. Once testing is initiated on the vehicle, you accept that the vehicle has been properly maintained and used.

(2) If a MIL illuminates or a trouble code appears on a test vehicle during a field test, stop the test and repair the vehicle. Determine test results as specified in § 1036.530 using one of the following options:

(i) Restart the testing and use only the portion of the full test results without the MIL illuminated or trouble code set.

(ii) Initiate a new test and use only the post-repair test results.

(3) If you determine that repairs are needed but they cannot be completed in a timely manner, you may disqualify the vehicle and replace it with another vehicle.

(c) Use appropriate fuels for testing, as follows:

(1) You may use any diesel fuel that meets the specifications for S15 in ASTM D975 (incorporated by reference in § 1036.810). You may use any commercially available biodiesel fuel blend that meets the specifications for ASTM D975 or ASTM D7467 (incorporated by reference in § 1036.810) that is either expressly allowed or not otherwise indicated as an unacceptable fuel in the vehicle's owner or operator manual or in the engine manufacturer's published fuel recommendations. You may use any gasoline fuel that meets the specifications in ASTM D4814 (incorporated by reference in § 1036.810). For other fuel types, you may use any commercially available fuel.

(2) You may drain test vehicles' fuel tanks and refill them with diesel fuel conforming to the specifications in paragraph (c)(1) of this section.

(3) Any fuel that is added to a test vehicle's fuel tanks must be purchased at a local retail establishment near the site of vehicle recruitment or screening, or along the test route. Alternatively, the

fuel may be drawn from a central fueling source, as long as the fuel represents commercially available fuel in the area of testing.

(4) No post-refinery fuel additives are allowed, except that specific fuel additives may be used during field testing if you can document that the test vehicle has a history of normally using the fuel treatments and they are not prohibited in the owners manual or in your published fuel-additive recommendations.

(5) You may take fuel samples from test vehicles to ensure that appropriate fuels were used during field testing. If a vehicle fails the vehicle-pass criteria and you can show that an inappropriate fuel was used during the failed test, that particular test may be voided. You may drain vehicles' fuel tanks and refill them with diesel fuel conforming to the specifications described in paragraph (c)(1) of this section. You must report any fuel tests that are the basis of voiding a test in your report under § 1036.430.

(d) You must test the selected engines using the test procedure described in § 1036.530 while they remain installed in the vehicle. Testing consists of characterizing emission rates for moving average 300 second windows while driving, with those windows divided into bins representing different types of engine operation over a shift-day. Measure emissions as follows:

(1) Perform all testing with PEMS and field-testing procedures referenced in 40 CFR part 1065, subpart J. Measure emissions of NO<sub>x</sub>, CO, and CO<sub>2</sub>. We may require you to also measure emissions of HC and PM. You may determine HC emissions by any method specified in 40 CFR 1065.660(b).

(2) If the engine's crankcase discharges emissions into the ambient atmosphere, as allowed by § 1036.115(a), you must either route all crankcase emissions into the exhaust for a combined measurement or add the crankcase emission values specified in § 1036.240(e) to represent emission levels at full useful life instead of measuring crankcase emissions in the field.

(e) Operate the test vehicle under conditions reasonably expected during normal operation. For the purposes of this subpart, normal operation generally includes the vehicle's normal routes and loads (including auxiliary loads such as air conditioning in the cab), normal ambient conditions, and the normal driver.

(f) Once an engine is set up for testing, test the engine for one shift-day, except as allowed in § 1036.420(d). To complete a shift-day's worth of testing,

start sampling at the beginning of a shift and continue sampling for the whole shift, subject to the calibration requirements of the PEMS. A shift-day is the period of a normal workday for an individual employee. Evaluate the emission data as described in § 1036.420 and include the data in the reporting and record keeping requirements specified in §§ 1036.430 and 1036.435.

(g) For stop-start and automatic engine shutdown systems meeting the

specifications of 40 CFR 1037.660, override idle-reduction features if they are adjustable under 40 CFR 1037.520(j)(4). If those systems are tamper-resistant under 40 CFR 1037.520(j)(4), set the 1-Hz emission rate to zero for all regulated pollutants when the idle-reduction feature is active. Do not exclude these data points under § 1036.530(c)(3)(ii).

**§ 1036.420 Pass criteria for individual engines.**

Perform the following steps to determine whether an engine meets the binned emission standards in § 1036.104(a)(3):

(a) Determine the emission standard for each regulated pollutant for each bin by adding the following accuracy margins for PEMS to the off-cycle standards in § 1036.104(a)(3):

TABLE 1 TO PARAGRAPH (a) OF § 1036.420—ACCURACY MARGINS FOR IN-USE TESTING

	NO <sub>x</sub>	HC	PM	CO
Bin 1 .....	0.4 g/hr.			
Bin 2 .....	5 mg/hp-hr .....	10 mg/hp-hr .....	6 mg/hp-hr .....	0.025 g/hp-hr.

(b) Calculate the mass emission rate for each pollutant as specified in § 1036.530.

(c) For engines subject to compression-ignition standards, determine the number of windows in each bin. A bin is valid under this section only if it has at least 2,400 windows for bin 1 and 10,000 windows for bin 2.

(d) Continue testing additional shift-days as necessary to achieve the minimum window requirements for each bin. You may idle the engine at the end of the shift day to increase the number of windows in bin 1. If the vehicle has tamper-resistant idle-reduction technology that prevents idling, populate bin 1 with additional windows by setting the 1-Hz emission rate for all regulated pollutants to zero as described in § 1036.415(g) to achieve exactly 2,400 bin 1 windows.

(e) An engine passes if the result for each bin is at or below the standard determined in paragraph (a) of this section. An engine fails if the result for any bin for any pollutant is above the standard determined in paragraph (a) of this section.

**§ 1036.425 Pass criteria for engine families.**

For testing with PEMS under § 1036.415(d)(1), determine the number of engines you must test from each selected engine family and the family pass criteria as follows:

(a) Start by measuring emissions from five engines using the procedures described in this subpart E and § 1036.530. If all five engines comply fully with the off-cycle bin standards, the engine family passes, and you may stop testing.

(b) If only one of the engines tested under paragraph (a) of this section does not comply fully with the off-cycle bin

standards, test one more engine. If this additional engine complies fully with the off-cycle bin standards, the engine family passes, and you may stop testing.

(c) If two or more engines tested under paragraphs (a) and (b) of this section do not comply fully with the off-cycle bin standards, test additional engines until you have tested a total of ten engines. Calculate the arithmetic mean of the bin emissions from the ten engine tests as specified in § 1036.530(g) for each pollutant. If the mean values are at or below the off-cycle bin standards, the engine family passes. If the mean value for any pollutant is above an off-cycle bin standard, the engine family fails.

(d) You may accept a fail result for the engine family and discontinue testing at any point in the sequence of testing the specified number of engines.

**§ 1036.430 Reporting requirements.**

(a) *Report content.* Prepare test reports as follows:

(1) Include the following for each engine family:

(i) Describe how you recruited vehicles. Describe how you used any criteria or thresholds to narrow your search or to screen individual vehicles.

(ii) Include a summary of the vehicles you have disqualified and the reasons you disqualified them, whether you base the disqualification on the criteria in § 1036.410(b), owner nonparticipation, or anything else. If you disqualified a vehicle due to misfueling, include the results of any fuel sample tests. If you reject a vehicle due to tampering, describe how you determined that tampering occurred.

(iii) Identify how many engines you have tested from the applicable engine family and how many engines still need to be tested. Identify how many tested

engines have passed or failed under § 1036.420.

(iv) After the final test, report the results and state the outcome of testing for the engine family based on the criteria in § 1036.425.

(v) Describe any incomplete or invalid tests that were conducted under this subpart.

(2) Include the following information for the test vehicle:

(i) The EPA engine-family designation, and the engine's model number, total displacement, and power rating.

(ii) The date EPA selected the engine family for testing.

(iii) The vehicle's make and model and the year it was built.

(iv) The vehicle identification number and engine serial number.

(v) The vehicle's type or application (such as delivery, line haul, or dump truck). Also, identify the type of trailer, if applicable.

(vi) The vehicle's maintenance and use history.

(vii) The known status history of the vehicle's OBD system and any actions taken to address OBD trouble codes or MIL illumination over the vehicle's lifetime.

(viii) Any OBD codes or MIL illumination that occur after you accept the vehicle for field testing under this subpart.

(ix) Any steps you take to maintain, adjust, modify, or repair the vehicle or its engine to prepare for or continue testing, including actions to address OBD trouble codes or MIL illumination. Include any steps you took to drain and refill the vehicle's fuel tank(s) to correct misfueling, and the results of any fuel test conducted to identify misfueling.

(3) Include the following data and measurements for each test vehicle:

(i) The date and time of testing, and the test number.

(ii) Number of shift-days of testing (see § 1036.415(f)).

(iii) Route and location of testing. You may base this description on the output from a global-positioning system (GPS).

(iv) The steps you took to ensure that vehicle operation during testing was consistent with normal operation and use, as described in § 1036.415(e).

(v) Fuel test results, if fuel was tested under § 1036.410 or § 1036.415.

(vi) The vehicle's mileage at the start of testing. Include the engine's total lifetime hours of operation, if available.

(vii) The number of windows in each bin (see § 1036.420(c)).

(viii) The bin emission value per vehicle for each pollutant. Describe the method you used to determine HC as specified in 40 CFR 1065.660(b).

(ix) Recorded 1 Hz test data for at least the following parameters, noting that gaps in the 1 Hz data file over the shift-day are only allowed during analyzer zero and span verifications and during engine shutdown when the engine is keyed off:

(A) Ambient temperature.

(B) Ambient pressure.

(C) Ambient humidity.

(D) Altitude.

(E) Emissions of HC, CO, CO<sub>2</sub>, and NO<sub>x</sub>. Report results for PM if it was measured in a manner that provides 1 Hz test data.

(F) Differential backpressure of any PEMS attachments to vehicle exhaust.

(G) Exhaust flow.

(H) Exhaust aftertreatment temperatures.

(I) Engine speed.

(J) Engine brake torque.

(K) Engine coolant temperature

(L) Intake manifold temperature.

(M) Intake manifold pressure.

(N) Throttle position.

(O) Any parameter sensed or controlled, available over the Controller Area Network (CAN) network, to modulate the emission control system or fuel-injection timing.

(4) Include the following summary information after you complete testing with each engine:

(i) State whether the engine meets the off-cycle standards for each bin for each pollutant as described in § 1036.420(e).

(ii) Describe if any testing or evaluations were conducted to determine why a vehicle failed the off-cycle emission standards described in § 1036.420.

(iii) Describe the purpose of any diagnostic procedures you conduct.

(iv) Describe any instances in which the OBD system illuminated the MIL or set trouble codes. Also describe any actions taken to address the trouble codes or MIL.

(v) Describe any instances of misfueling, the approved actions taken to address the problem, and the results of any associated fuel sample testing.

(vi) Describe the number and length of any data gaps in the 1 Hz data file, the reason for the gap(s), and the parameters affected.

(b) *Submission.* Send electronic reports to the Designated Compliance Officer using an approved information format. If you want to use a different format, send us a written request with justification.

(1) You may send us reports as you complete testing for an engine instead of waiting until you complete testing for all engines.

(2) We may ask you to send us less information in your reports than we specify in this section.

(3) We may require you to send us more information to evaluate whether your engine family meets the requirements of this part.

(4) Once you send us information under this section, you need not send that information again in later reports.

(c) *Additional notifications.* Notify the Designated Compliance Officer describing progress toward completing the required testing and reporting under this subpart, as follows:

(1) Notify us once you complete testing for an engine.

(2) Notify us if your review of the test data for an engine family indicates that two of the first five tested engines have failed to comply with the vehicle-pass criteria in § 1036.420(e).

(3) Notify us if your review of the test data for an engine family indicates that the engine family does not comply with the family-pass criteria in § 1036.425(c).

(4) Describe any voluntary vehicle/engine emission evaluation testing you intend to conduct with PEMS on the same engine families that are being tested under this subpart, from the time that engine family was selected for field testing under § 1036.405 until the final results of all testing for that engine family are reported to us under this section.

#### § 1036.435 Recordkeeping requirements.

Keep the following paper or electronic records of your field testing for five years after you complete all the testing required for an engine family:

(a) Keep a copy of the reports described in § 1036.430.

(b) Keep any additional records, including forms you create, related to any of the following:

(1) The recruitment, screening, and selection process described in § 1036.410, including the vehicle owner's name, address, phone number, and email address.

(2) Pre-test maintenance and adjustments to the engine performed under § 1036.415.

(3) Test results for all void, incomplete, and voluntary testing described in § 1036.430.

(4) Evaluations to determine why an engine failed any of the bin standards described in § 1036.420.

(c) Keep a copy of the relevant calibration results required by 40 CFR part 1065.

#### § 1036.440 Warranty obligations related to in-use testing.

Testing under this subpart that finds an engine exceeding emission standards under this subpart is not by itself sufficient to show a breach of warranty under 42 U.S.C. 7541(a)(1). A breach of warranty would also require that engines fail to meet one or both of the conditions specified in § 1036.120(a).

#### Subpart F—Test Procedures

##### § 1036.501 General testing provisions.

(a) Use the equipment and procedures specified in this subpart and 40 CFR part 1065 to determine whether engines meet the emission standards in §§ 1036.104 and 1036.108.

(b) Use the fuels specified in 40 CFR part 1065 to perform valid tests, as follows:

(1) For service accumulation, use the test fuel or any commercially available fuel that is representative of the fuel that in-use engines will use.

(2) For diesel-fueled engines, use the ultra-low-sulfur diesel fuel specified in 40 CFR part 1065.703 and 40 CFR 1065.710(b)(3) for emission testing.

(3) For gasoline-fueled engines, use the appropriate E10 fuel specified in 40 CFR part 1065.

(c) For engines that use aftertreatment technology with infrequent regeneration events, apply infrequent regeneration adjustment factors for each duty cycle as described in § 1036.580.

(d) If your engine is intended for installation in a vehicle equipped with stop-start technology meeting the specifications of 40 CFR 1037.660 to qualify as tamper-resistant under 40 CFR 1037.520(j)(4), you may shut the engine down during idle portions of the duty cycle to represent in-use operation. We recommend installing a production engine starter motor and letting the engine's ECM manipulate the starter motor to control the engine stop and start events. Use good engineering judgment to address the effects of dynamometer inertia on restarting the engine by, for example, using a larger starter motor or declutching the engine from the dynamometer during restart.

(e) You may use special or alternate procedures to the extent we allow them under 40 CFR 1065.10.

(f) This subpart is addressed to you as a manufacturer, but it applies equally to anyone who does testing for you, and to us when we perform testing to determine if your engines meet emission standards.

**§ 1036.505 Engine data and information to support vehicle certification.**

You must give vehicle manufacturers information as follows so they can certify their vehicles to greenhouse gas emission standards under 40 CFR part 1037:

(a) Identify engine make, model, fuel type, combustion type, engine family name, calibration identification, and engine displacement. Also identify whether the engines meet CO<sub>2</sub> standards for tractors, vocational vehicles, or both.

(b) This paragraph (b) describes four different methods to generate engine fuel maps. For engines without hybrid components and for mild hybrid engines where you do not include hybrid components in the test, generate fuel maps using either paragraph (b)(1) or (2) of this section. For other hybrid engines, generate fuel maps using paragraph (b)(3) of this section. For hybrid and nonhybrid powertrains and for vehicles where the transmission is not automatic, automated manual, manual, or dual-clutch, generate fuel maps using paragraph (b)(4) of this section.

(1) Determine steady-state engine fuel maps as described in § 1036.535(b). Determine fuel consumption at idle as described in § 1036.535 (c). Determine cycle-average engine fuel maps as described in § 1036.540, excluding cycle-average fuel maps for highway cruise cycles.

(2) Determine steady-state fuel maps as described in either § 1036.535(b) or (d). Determine fuel consumption at idle as described in § 1036.535(c). Determine cycle-average engine fuel maps as described in § 1036.540, including cycle-average engine fuel maps for highway cruise cycles. We may do confirmatory testing by creating cycle-average fuel maps from steady-state fuel maps created in paragraph (b)(1) of this section for highway cruise cycles. In § 1036.540 we define the vehicle configurations for testing; we may add more vehicle configurations to better represent your engine’s operation for the range of vehicles in which your engines will be installed (see 40 CFR 1065.10(c)(1)).

(3) Determine fuel consumption at idle as described in § 1036.535(c) and (d) and determine cycle-average engine fuel maps as described in 40 CFR 1037.550, including cycle-average engine fuel maps for highway cruise cycles. Set up the test to apply accessory load for all operation by primary intended service class as described in the following table:

TABLE 1 TO PARAGRAPH (b)(3) OF § 1036.505—ACCESSORY LOAD

Primary intended service class	Power representing accessory load (kW)
Light HDV .....	1.5
Medium HDV .....	2.5
Heavy HDV .....	3.5

(4) Generate powertrain fuel maps as described in 40 CFR 1037.550 instead of fuel mapping under § 1036.535 or § 1036.540. Note that the option in 40 CFR 1037.550(b)(2) is allowed only for hybrid engine testing. Disable stop-start systems and automatic engine shutdown systems when conducting powertrain fuel map testing using 40 CFR 1037.550.

(c) Provide the following information if you generate engine fuel maps using either paragraph (b)(1), (2), or (3) of this section:

(1) Full-load torque curve for installed engines and the full-load torque curve of the engine (parent engine) with the highest fueling rate that shares the same engine hardware, including the turbocharger, as described in 40 CFR 1065.510. You may use 40 CFR 1065.510(b)(5)(i) for Spark-ignition HDE. Measure the torque curve for hybrid engines that have an RESS as described in 40 CFR 1065.510(g)(2) with the hybrid system active. Test hybrid engines with no RESS as described in 40 CFR 1065.510(b)(5)(ii).

(2) Motoring torque curve as described in 40 CFR 1065.510(c)(2) and (5) for nonhybrid and hybrid engines, respectively. For engines with a low-speed governor, remove data points where the low-speed governor is active. If you don’t know when the low-speed governor is active, we recommend removing all points below 40 r/min above the warm low-idle speed.

(3) Declared engine idle speed. For vehicles with manual transmissions, this is the engine speed with the transmission in neutral. For all other vehicles, this is the engine’s idle speed when the transmission is in drive.

(4) The engine idle speed during the transient cycle-average fuel map.

(5) The engine idle torque during the transient cycle-average fuel map.

(d) If you generate powertrain fuel maps using paragraph (b)(4) of this section, determine the system continuous rated power according to § 1036.520.

**§ 1036.510 Supplemental Emission Test.**

(a) Measure emissions using the steady-state SET duty cycle as described in this section. Note that the SET duty cycle is operated as a ramped-modal cycle rather than discrete steady-state test points.

(b) Perform SET testing with one of the following procedures:

(1) For testing nonhybrid engines, the SET duty cycle is based on normalized speed and torque values relative to certain maximum values. Denormalize speed as described in 40 CFR 1065.512. Denormalize torque as described in 40 CFR 1065.610(d). Note that idle points are to be run at conditions simulating neutral or park on the transmission.

(2) Test hybrid engines and hybrid powertrains as described in 40 CFR 1037.550, except as specified in this paragraph (b)(2). Do not compensate the duty cycle for the distance driven as described in 40 CFR 1037.550(g)(4). For hybrid engines, select the transmission from Table 1 of § 1036.540, substituting “engine” for “vehicle” and “highway cruise cycle” for “SET”. Disregard duty cycles in 40 CFR 1037.550(j). For cycles that begin with idle, leave the transmission in neutral or park for the full initial idle segment. Place the transmission into drive no earlier than 5 seconds before the first nonzero vehicle speed setpoint. For SET testing only, place the transmission into park or neutral when the cycle reaches the final idle segment. Use the following vehicle parameters instead of those in 40 CFR 1037.550 to define the vehicle model in 40 CFR 1037.550(a)(3):

(i) Determine the vehicle test mass, *M*, as follows:

$$M = 15.1 \cdot P_{\text{contrated}}^{1.31}$$

Eq. 1036.510-1

Where:

*P*<sub>contrated</sub> = the continuous rated power of the hybrid system determined in sect; 1036.520.

Example:

$$P_{\text{contrated}} = 350.1 \text{ kW}$$

$$M = 15.1 \cdot 350.1^{1.31}$$

$$M = 32499 \text{ kg}$$

(ii) Determine the vehicle frontal area, *A*<sub>front</sub>, as follows:

(A) For *M* ≤ 18050 kg:

$$A_{\text{front}} = -1.69 \cdot 10^{-8} \cdot M^2 + 6.33 \cdot 10^{-4} \cdot M + 1.67$$

Eq. 1036.510-2

*Example:*

$M = 16499 \text{ kg}$

$$A_{\text{front}} = -1.69 \cdot 10^{-8} \cdot 16499^2 + 6.33 \cdot 10^{-4} \cdot 16499 + 1.67$$

$$A_{\text{front}} = 7.51 \text{ m}^2$$

(B) For  $M > 18050 \text{ kg}$ ,  $A_{\text{front}} = 7.59 \text{ m}^2$   
 (iii) Determine the vehicle drag area,  $C_d A$ , as follows:

$$C_d A = \frac{(0.00299 \cdot A_{\text{front}} - 0.000832) \cdot 2 \cdot g \cdot 3.6^2}{\rho}$$

Eq. 1036.510-3

Where:

$g = \text{gravitational constant} = 9.80665 \text{ m/s}^2$ .

$\rho = \text{air density at reference conditions. Use}$   
 $\rho = 1.1845 \text{ kg/m}^3$ .

*Example:*

$$C_d A = \frac{(0.00299 \cdot 7.59 - 0.000832) \cdot 2 \cdot 9.80665 \cdot 3.6^2}{1.1845}$$

$$C_d A = 3.08 \text{ m}^2$$

$$C_d A = 3.08 \text{ m}^2$$

(iv) Determine the coefficient of rolling resistance,  $C_{rr}$ , as follows:

$$C_{rr} = 5.13 + \frac{17600}{M}$$

Eq. 1036.510-4

*Example:*

$$C_{rr} = 5.13 + \frac{17600}{32499}$$

$$C_{rr} = 5.7 \text{ N/kN} = 0.0057 \text{ N/N}$$

(v) Determine the vehicle curb mass,  $M_{\text{curb}}$ , as follows:

$$M_{\text{curb}} = -0.000007376537 \cdot M^2 + 0.6038432 \cdot M$$

Eq. 1036.510-5

*Example:*

$$M_{\text{curb}} = -0.000007376537 \cdot 32499^2 + 0.6038432 \cdot 32499$$

$$M_{\text{curb}} = 11833 \text{ kg}$$

(vi) Determine the linear equivalent mass of rotational moment of inertias,  $M_{\text{rotating}}$ , as follows:

$$M_{\text{rotating}} = 0.07 \cdot M_{\text{curb}}$$

Eq. 1036.510-6

*Example:*

$$M_{\text{rotating}} = 0.07 \cdot 11833$$

$$M_{\text{rotating}} = 828.3 \text{ kg}$$

(vii) Select a drive axle ratio,  $k_a$ , that represents the worst-case combination of final gear ratio, drive axle ratio, and tire size for CO<sub>2</sub> expected for vehicles in which the hybrid powertrain or hybrid engine will be installed. This is typically the highest axle ratio.

(viii) Select a tire radius,  $r$ , that represents the worst-case pair of tire size and drive axle ratio for CO<sub>2</sub>

expected for vehicles in which the hybrid powertrain or hybrid engine will be installed. This is typically the smallest tire radius.

(ix) If you are certifying a hybrid engine, use a default transmission efficiency of 0.95 and create the vehicle model along with its default transmission shift strategy as described in 40 CFR 1037.550(a)(3)(ii). Use the transmission parameters defined in Table 1 of § 1036.540 to determine transmission type and gear ratio. For Light HDV and Medium HDV, use the Light HDV and Medium HDV parameters for FTP, LLC, and SET duty cycles. For Tractors and Heavy HDVs, use the Tractor and Heavy HDV transient cycle parameters for the FTP and LLC duty cycles and the Tractor and Heavy HDV highway cruise cycle parameters for the SET duty cycle.

(c) Measure emissions using the SET duty cycle shown in Table 1 of this section to determine whether engines

meet the steady-state compression-ignition standards specified in subpart B of this part. Table 1 of this section specifies test settings, as follows:

(1) The duty cycle for testing nonhybrid engines involves a schedule of normalized engine speed and torque values. Note that nonhybrid powertrains are generally tested as engines, so this section does not describe separate procedures for that configuration.

(2) The duty cycle for testing hybrid engines and hybrid powertrains involves a schedule of vehicle speeds and road grade as follows:

(i) Determine road grade at each point based on the continuous rated power of the hybrid powertrain system,  $P_{\text{contrated}}$ , in kW determined in § 1036.520, the vehicle speed (A, B, or C) in mi/hr for a given SET mode,  $v_{\text{ref[ speed]}}$ , and the specified road-grade coefficients using the following equation:

$$\text{Roadgrade} = a \cdot P_{\text{contrated}}^3 + b \cdot P_{\text{contrated}}^2 \cdot v_{\text{ref}[\text{speed}]} + c \cdot P_{\text{contrated}}^2 + d \cdot v_{\text{ref}[\text{speed}]}^2 + e \\ \cdot P_{\text{contrated}} \cdot v_{\text{ref}[\text{speed}]} + f \cdot P_{\text{contrated}} + g \cdot v_{\text{ref}[\text{speed}]} + h$$

Eq. 1036.510-7

Example for SET mode 3a in Table 1 of this section:

$$P_{\text{contrated}} = 345.2 \text{ kW}$$

$$v_{\text{refB}} = 59.3 \text{ mi/hr}$$

$$\text{Road grade} = 8.296 \cdot 10^{-9} \cdot 345.2^3 + (-4.752 \cdot 10^{-7}) \cdot 345.2^2 \cdot 59.3 + 1.291 \cdot 10^{-5} \cdot 345.2^2 + 2.88 \cdot 10^{-4} \cdot 59.3^2 + 4.524 \cdot 10^{-4} \cdot 345.2 \cdot 59.3 + (-1.802 \cdot 10^{-2}) \cdot 345.2 + (-1.83 \cdot 10^{-1}) \cdot 59.3 + 8.81$$

$$\text{Road grade} = 0.53\%$$

(ii) Use the vehicle C speed determined in § 1036.520. Determine vehicle A and B speeds as follows:

(A) Determine vehicle A speed using the following equation:

$$v_{\text{refA}} = v_{\text{refC}} \cdot \frac{55.0}{75.0}$$

Eq. 1036.510-8

Example:

$$v_{\text{refC}} = 68.42 \text{ mi/hr}$$

$$v_{\text{refA}} = 68.4 \cdot \frac{55.0}{75.0}$$

$$v_{\text{refA}} = 50.2 \text{ mi/hr}$$

(B) Determine vehicle B speed using the following equation:

$$v_{\text{refB}} = v_{\text{refC}} \cdot \frac{65.0}{75.0}$$

Eq. 1036.510-9

Example:

$$v_{\text{refB}} = 68.4 \cdot \frac{65.0}{75.0}$$

$$v_{\text{refB}} = 59.3 \text{ mi/hr}$$

(3) Table 1 follows:

**BILLING CODE 6560-50-P**



Table 1 to Paragraph (c)(3) of § 1036.510—Supplemental Emission Test

SET mode	Engine testing			Hybrid power train testing								
	Time in mode (seconds)	Engine speed <sup>a,b</sup>	Torque <sup>b,c</sup> (percent)	Vehicle speed (mi/hr)	Road-grade coefficients							
					a	b	c	d	e	f	g	h
1a Steady-state	124	Warm Idle	0	0	0	0	0	0	0	0	0	0
1b Transition <sup>d</sup>	20	Linear Transition	Linear Transition	Linear Transition	-1.90E-08	-5.90E-07	3.78E-05	4.71E-03	6.55E-04	-2.68E-02	-1.03E+00	1.54E+01
2a Steady-state	196	A	100	v <sub>refA</sub>	-1.23E-08	-5.50E-07	3.95E-05	1.21E-03	5.29E-04	-3.12E-02	-3.23E-01	1.62E+01
2b Transition <sup>d</sup>	20	Linear Transition	Linear Transition	Linear Transition	-2.31E-09	-4.87E-07	2.54E-05	8.16E-04	4.73E-04	-2.38E-02	-2.98E-01	1.28E+01
3a Steady-state	220	B	50	v <sub>refB</sub>	8.30E-09	-4.75E-07	1.29E-05	2.88E-04	4.52E-04	-1.80E-02	-1.83E-01	8.81E+00
3b Transition	20	B	Linear Transition	v <sub>refB</sub>	4.64E-09	-5.14E-07	1.99E-05	3.56E-04	4.87E-04	-2.24E-02	-2.05E-01	1.07E+01
4a Steady-state	220	B	75	v <sub>refB</sub>	1.82E-10	-5.23E-07	2.58E-05	5.58E-04	5.01E-04	-2.56E-02	-2.40E-01	1.29E+01
4b Transition <sup>d</sup>	20	Linear Transition	Linear Transition	Linear Transition	5.84E-10	-4.99E-07	2.24E-05	4.70E-04	4.66E-04	-2.20E-02	-1.76E-01	1.07E+01
5a Steady-state	268	A	50	v <sub>refA</sub>	3.97E-09	-4.36E-07	1.37E-05	4.85E-04	4.16E-04	-1.61E-02	-1.91E-01	8.21E+00
5b Transition	20	A	Linear Transition	v <sub>refA</sub>	-2.79E-10	-4.23E-07	1.81E-05	6.59E-04	4.16E-04	-1.85E-02	-2.20E-01	1.00E+01
6a Steady-state	268	A	75	v <sub>refA</sub>	-4.22E-09	-4.89E-07	2.64E-05	8.80E-04	4.69E-04	-2.35E-02	-2.60E-01	1.23E+01
6b Transition	20	A	Linear Transition	v <sub>refA</sub>	3.98E-09	-4.39E-07	1.41E-05	2.08E-04	4.20E-04	-1.66E-02	-1.66E-01	7.71E+00
7a Steady-state	268	A	25	v <sub>refA</sub>	1.21E-08	-3.77E-07	6.21E-07	1.20E-04	3.58E-04	-8.42E-03	-1.25E-01	4.19E+00
7b Transition <sup>d</sup>	20	Linear Transition	Linear Transition	Linear Transition	1.66E-09	-4.95E-07	2.10E-05	4.85E-04	4.78E-04	-2.19E-02	-2.55E-01	1.08E+01
8a Steady-state	196	B	100	v <sub>refB</sub>	-8.23E-09	-5.71E-07	3.90E-05	8.15E-04	5.48E-04	-3.33E-02	-2.96E-01	1.69E+01
8b Transition	20	B	Linear Transition	v <sub>refB</sub>	4.29E-09	-5.15E-07	2.07E-05	5.21E-04	4.88E-04	-2.29E-02	-2.27E-01	1.16E+01
9a Steady-state	196	B	25	v <sub>refB</sub>	1.66E-08	-4.26E-07	-2.71E-07	2.10E-05	4.05E-04	-1.04E-02	-1.26E-01	4.75E+00
9b Transition <sup>d</sup>	20	Linear Transition	Linear Transition	Linear Transition	7.49E-09	-5.45E-07	1.95E-05	2.24E-04	5.11E-04	-2.33E-02	-2.27E-01	1.06E+01
10a Steady-state	28	C	100	v <sub>refC</sub>	-1.07E-09	-5.90E-07	3.48E-05	5.07E-04	5.65E-04	-3.35E-02	-2.65E-01	1.65E+01
10b Transition	20	C	Linear Transition	v <sub>refC</sub>	9.96E-09	-5.48E-07	1.83E-05	2.40E-04	5.20E-04	-2.41E-02	-2.01E-01	1.13E+01
11a Steady-state	4	C	25	v <sub>refC</sub>	1.92E-08	-5.02E-07	3.72E-06	3.63E-05	4.71E-04	-1.54E-02	-1.49E-01	6.83E+00
11b Transition	20	C	Linear Transition	v <sub>refC</sub>	1.47E-08	-5.18E-07	1.03E-05	1.19E-04	4.91E-04	-1.94E-02	-1.71E-01	8.87E+00
12a Steady-state	4	C	75	v <sub>refC</sub>	6.17E-09	-5.58E-07	2.35E-05	3.52E-04	5.32E-04	-2.71E-02	-2.25E-01	1.31E+01
12b Transition	20	C	Linear Transition	v <sub>refC</sub>	1.04E-08	-5.45E-07	1.76E-05	2.26E-04	5.17E-04	-2.37E-02	-1.98E-01	1.11E+01
13a Steady-state	4	C	50	v <sub>refC</sub>	6.21E-09	-5.29E-07	2.13E-05	3.48E-04	5.13E-04	-2.55E-02	-2.21E-01	1.27E+01
13b Transition <sup>d</sup>	20	Linear Transition	Linear Transition	Linear Transition	4.46E-09	-6.45E-07	1.30E-05	1.42E-03	5.78E-04	-1.56E-02	1.95E-01	8.00E+00
14 Steady-state	144	Warm Idle	0	0	0	0	0	0	0	0	0	0

<sup>a</sup>Engine speed terms are defined in 40 CFR part 1065.

<sup>b</sup>Advance from one mode to the next within a 20 second transition phase. During the transition phase, command a linear progression from the settings of the current mode to the

<sup>c</sup>The percent torque is relative to maximum torque at the commanded engine speed.

<sup>d</sup>Use the average vehicle speed during each transition for v<sub>ref</sub> in Eq. 1036.510-7 for calculating road grade for all points during the transition.

**BILLING CODE 6560-50-C**

(d) Determine criteria pollutant emissions for plug-in hybrid engines and powertrains as follows:

(1) Precondition the engine or powertrain in charge-sustaining mode. Perform testing as described in this section for hybrid engines and hybrid powertrains in charge-sustaining mode.

(2) Carry out a charge-depleting test as described in paragraph (d)(1) of this section, except as follows:

(i) Fully charge the RESS after preconditioning.

(ii) Operate the hybrid engine or powertrain continuously over repeated SET duty cycles until you reach the end-of-test criterion defined in 40 CFR 1066.501(a)(3).

(iii) Calculate emission results for each SET duty cycle. Figure 1 of this section provides an example of a charge-depleting test sequence where there are

two test intervals that contain engine operation.

(3) Report the highest emission result for each criteria pollutant from all tests in paragraphs (d)(1) and (2) of this section, even if those individual results come from different test intervals.

(4) Figure 1 follows:

**Figure 1 to Paragraph (d)(4) of § 1036.510—SET Charge-Depleting Criteria Pollutant Test Sequence**

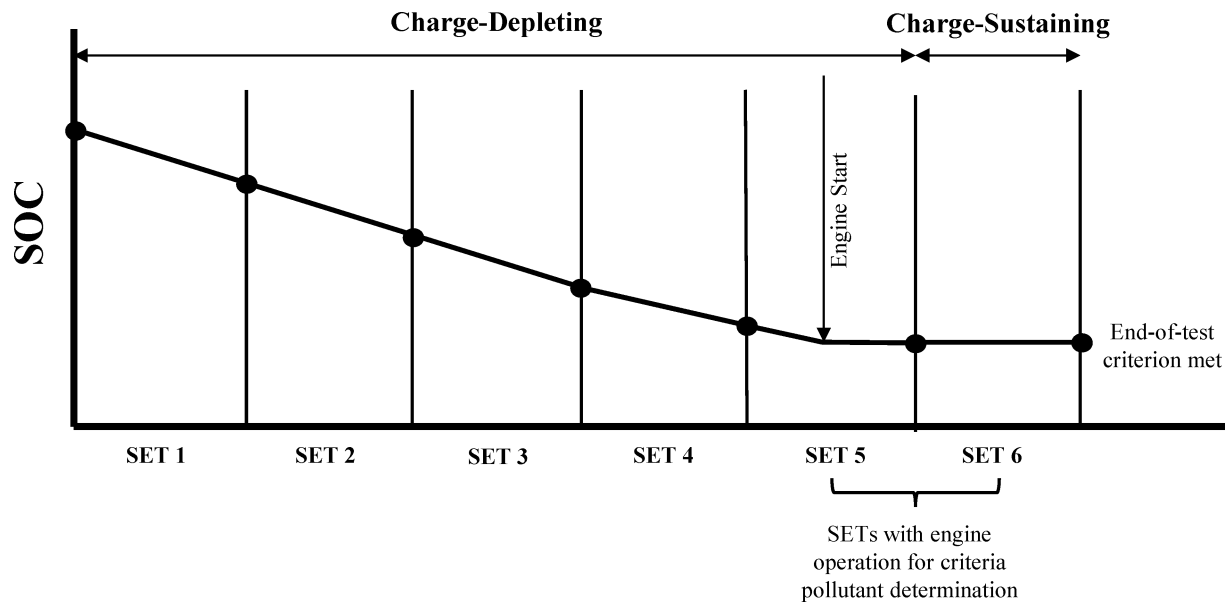

(e) Determine greenhouse gas pollutant emissions for plug-in hybrid engines and powertrains using the emissions results for all the SET test

intervals for both charge-depleting and charge-sustaining operation from paragraph (d)(2) of this section. Calculate the utility factor-weighted

composite mass of emissions from the charge-depleting and charge-sustaining test results,  $e_{UF[emission]comp}$ , using the following equation:

$$e_{UF[emission]comp} = \frac{\sum_{i=1}^N [e_{[emission][int]CDi} \cdot (UF_{DCDi} - UF_{DCDi-1})]}{(1 - UF_{RCD})} + \sum_{j=1}^M [e_{[emission][int]CSj}]$$

Eq. 1036.510-10

Where:

$i$  = an indexing variable that represents one test interval.

$N$  = total number of charge-depleting test intervals.

$e_{[emission][int]CDi}$  = total mass of emissions in the charge-depleting portion of the test for each test interval,  $i$ , starting from  $i = 1$ , including the test interval(s) from the transition phase.

$UF_{DCDi}$  = utility factor fraction at distance  $D_{CDi}$  from Eq. 1036.510-11, as determined by interpolating the approved utility factor curve for each test interval,  $i$ , starting from  $i = 1$ . Let  $UF_{DCD0} = 0$ .

$j$  = an indexing variable that represents one test interval.

$M$  = total number of charge-sustaining test intervals.

$e_{[emission][int]CSj}$  = total mass of emissions in the charge-sustaining portion of the test for each test interval,  $j$ , starting from  $j = 1$ .

$UF_{RCD}$  = utility factor fraction at the full charge-depleting distance,  $R_{CD}$ , as determined by interpolating the approved utility factor curve.  $R_{CD}$  is the cumulative distance driven over  $N$  charge-depleting test intervals.

$$D_{CDi} = \sum_{k=1}^Q (v_k \cdot \Delta t)$$

Eq. 1036.510-11

Where:

$k$  = an indexing variable that represents one recorded velocity value.

$Q$  = total number of measurements over the test interval.

$v$  = vehicle velocity at each time step,  $k$ , starting from  $k = 1$ . For tests completed under this section,  $v$  is the vehicle velocity from the vehicle model in 40 CFR 1037.550. Note that this should

include charge-depleting test intervals that start when the engine is not yet operating.  
 $\Delta t = 1/f_{\text{record}}$   
 $f_{\text{record}}$  = the record rate.

*Example using the charge-depletion test in Figure 1 of § 1036.510 for the SET for CO<sub>2</sub> emission determination:*  
 $Q = 24000$

$v_1 = 0$  mi/hr  
 $v_2 = 0.8$  mi/hr  
 $v_3 = 1.1$  mi/hr  
 $f_{\text{record}} = 10$  Hz  
 $\Delta t = 1/10$  Hz = 0.1 s

$$D_{\text{CD}1} = \sum_{k=1}^{24000} (0 \cdot 0.1 + 0.8 \cdot 0.1 + 1.1 \cdot 0.1 + v_{24000} \cdot \Delta t)$$

$D_{\text{CD}1} = 30.1$  mi  
 $D_{\text{CD}2} = 30.0$  mi  
 $D_{\text{CD}3} = 30.1$  mi  
 $D_{\text{CD}4} = 30.2$  mi  
 $D_{\text{CD}5} = 30.1$  mi  
 $N = 5$   
 $UF_{\text{DCD}1} = 0.11$

$UF_{\text{DCD}2} = 0.23$   
 $UF_{\text{DCD}3} = 0.34$   
 $UF_{\text{DCD}4} = 0.45$   
 $UF_{\text{DCD}5} = 0.53$   
 $e_{\text{CO}_2\text{SETCD}1} = 0$  g/hp·hr  
 $e_{\text{CO}_2\text{SETCD}2} = 0$  g/hp·hr  
 $e_{\text{CO}_2\text{SETCD}3} = 0$  g/hp·hr

$e_{\text{CO}_2\text{SETCD}4} = 0$  g/hp·hr  
 $e_{\text{CO}_2\text{SETCD}5} = 174.4$  g/hp·hr  
 $M = 1$   
 $e_{\text{CO}_2\text{SETCS}} = 428.1$  g/hp·hr  
 $UF_{\text{RCD}} = 0.53$

$$e_{\text{UFCO}_2\text{comp}} = [0 \cdot (0.11 - 0) + 0 \cdot (0.23 - 0.11) + 0 \cdot (0.34 - 0.23) + 0 \cdot (0.45 - 0.34) + 174.4 \cdot (0.53 - 0.45)] + 428.1 \cdot \frac{(1 - 0.53)}{1}$$

$e_{\text{UFCO}_2\text{comp}} = 215.2$  g/hp·hr

(f) Calculate and evaluate cycle statistics as specified in 40 CFR 1065.514 for nonhybrid engines and 40 CFR 1037.550 for hybrid engines and hybrid powertrains.

(g) Calculate cycle work for powertrain testing using system power,  $P_{\text{sys}}$ . Determine  $P_{\text{sys}}$ , using § 1036.520(f).

**§ 1036.512 Federal Test Procedure.**

(a) Measure emissions using the transient Federal Test Procedure (FTP) as described in this section to determine whether engines meet the emission standards in subpart B of this part. Operate the engine or hybrid powertrain over one of the following transient duty cycles:

(1) For engines subject to spark-ignition standards, use the transient test interval described in paragraph (b) of appendix B of this part.

(2) For engines subject to compression-ignition standards, use the transient test interval described in paragraph (c) of appendix B of this part.

(b) The following procedures apply differently for testing engines and hybrid powertrains:

(1) The transient test intervals for nonhybrid engine testing are based on normalized speed and torque values. Denormalize speed as described in 40 CFR 1065.512. Denormalize torque as described in 40 CFR 1065.610(d).

(2) Test hybrid engines and hybrid powertrains as described in § 1036.510(b)(2), with the following exceptions:

(i) Replace  $P_{\text{contrated}}$  with  $P_{\text{rated}}$ , which is the peak rated power determined in § 1036.520.

(ii) Keep the transmission in drive for all idle segments after the initial idle segment.

(iii) For hybrid engines, select the transmission from Table 1 of § 1036.540, substituting “engine” for “vehicle”.

(iv) For hybrid engines, you may request to change the engine-commanded torque at idle to better represent curb idle transmission torque (CITT).

(v) For plug-in hybrid engines and powertrains, test over the FTP in both charge-sustaining and charge-depleting operation for both criteria and greenhouse gas pollutant determination.

(c) The FTP duty cycle consists of an initial run through the test interval from a cold start as described in 40 CFR part 1065, subpart F, followed by a (20 ±1) minute hot soak with no engine operation, and then a final hot start run through the same transient test interval. Engine starting is part of both the cold-start and hot-start test intervals. Calculate the total emission mass of each constituent,  $m$ , and the total work,  $W$ , over each test interval as described in 40 CFR 1065.650. Calculate total work over each test interval for powertrain testing using system power,  $P_{\text{sys}}$ . Determine  $P_{\text{sys}}$  using § 1036.520(f). For powertrains with automatic transmissions, account for and include the work produced by the engine from the CITT load. Calculate the official transient emission result from the cold-start and hot-start test intervals using the following equation:

$$\text{Official transient emission result} = \frac{\text{cold start emissions (g)} + 6 \cdot \text{hot start emissions (g)}}{\text{cold start work (hp} \cdot \text{hr)} + 6 \cdot \text{hot start work (hp} \cdot \text{hr)}}$$

Eq. 1036.512-1

(d) Determine criteria pollutant emissions for plug-in hybrid engines and powertrains as follows:

(1) Precondition the engine or powertrain in charge-sustaining mode. Perform testing as described in this

section for hybrid engines and hybrid powertrains in charge-sustaining mode.

(2) Carry out a charge-depleting test as described in paragraph (d)(1) of this section, except as follows:

(i) Fully charge the battery after preconditioning.

(ii) Operate the hybrid engine or powertrain over one FTP duty cycle followed by alternating repeats of a 20-minute soak and a hot start test interval

until you reach the end-of-test criteria defined in 40 CFR 1066.501.

(iii) Calculate emission results for each successive pair of test intervals. Calculate the emission result by treating the first of the two test intervals as a cold-start test. Figure 1 of § 1036.512

provides an example of a charge-depleting test sequence where there are three test intervals with engine operation for two overlapping FTP duty cycles.

(3) Report the highest emission result for each criteria pollutant from all tests

in paragraphs (d)(1) and (2) of this section, even if those individual results come from different test intervals.

(4) Figure 1 follows:

**Figure 1 to paragraph (d)(4) of § 1036.512—FTP Charge-Depleting Criteria Pollutant Test Sequence.**

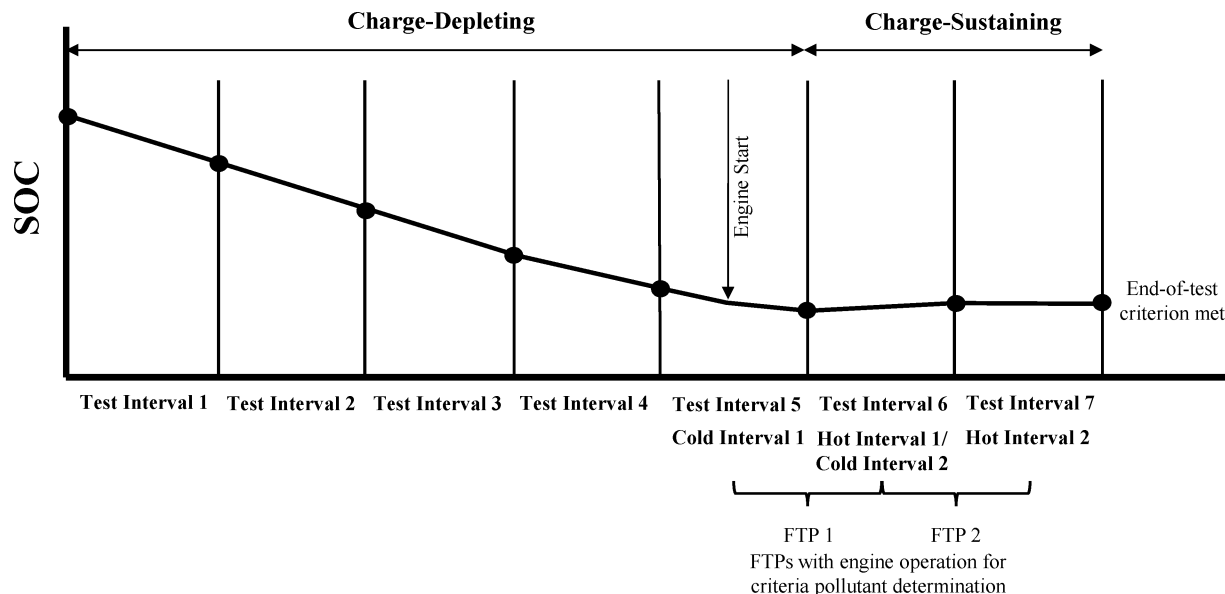

(e) Determine greenhouse gas pollutant emissions for plug-in hybrid engines and powertrains using the emissions results for all the transient duty cycle test intervals described in either paragraph (b) or (c) of appendix B of this part for both charge-depleting and charge-sustaining operation from paragraph (d)(2) of this section. Calculate the utility factor weighted composite mass of emissions from the charge-depleting and charge-sustaining test results,  $e_{UF[emission]comp}$ , as described in § 1036.510(e), replacing occurrences of “SET” with “transient test interval”. Note this results in composite FTP GHG emission results for plug-in hybrid engines and powertrains without the use of the cold-start and hot-start test interval weighting factors in Eq. 1036.512–1.

(f) Calculate and evaluate cycle statistics as specified in 40 CFR 1065.514 for nonhybrid engines and 40 CFR 1037.550 for hybrid engines and hybrid powertrains.

#### § 1036.514 Low Load Cycle.

(a) Measure emissions using the transient Low Load Cycle (LLC) as described in this section to determine whether engines meet the LLC emission standards in § 1036.104.

(b) The LLC duty cycle is described in paragraph (d) of appendix B of this part.

The following procedures apply differently for testing engines and hybrid powertrains:

(1) For nonhybrid engine testing, the duty cycle is based on normalized speed and torque values.

(i) Denormalize speed as described in 40 CFR 1065.512. Denormalize torque as described in 40 CFR 1065.610(d).

(ii) For idle segments more than 200 seconds, set reference torques to the torque needed to meet the accessory loads in Table 1 of this section instead of CITT. This is to represent shifting the transmission to park or neutral at the start of the idle segment. Change the reference torque to CITT no earlier than 5 seconds before the end of the idle segment. This is to represent shifting the transmission to drive.

(2) Test hybrid engines and hybrid powertrains as described in § 1036.510(b)(2), with the following exceptions:

(i) Replace  $P_{contrated}$  with  $P_{rated}$ , which is the peak rated power determined in § 1036.520.

(ii) Keep the transmission in drive for all idle segments 200 seconds or less. For idle segments more than 200 seconds, place the transmission in park or neutral at the start of the idle segment and place the transmission into drive again no earlier than 5 seconds before the first nonzero vehicle speed setpoint.

(iii) For hybrid engines, select the transmission from Table 1 of § 1036.540, substituting “engine” for “vehicle”.

(iv) For hybrid engines, you may request to change the engine-commanded torque at idle to better represent curb idle transmission torque (CITT).

(v) For plug-in hybrid engines and powertrains, determine criteria pollutant and greenhouse gas emissions as described in § 1036.510(d) and (e), replacing “SET” with “LLC”.

(c) Set dynamometer torque demand such that vehicle power represents an accessory load for all idle operation as described in Table 1 of paragraph (c)(4) of this section for each primary intended service class. Additional provisions related to accessory load apply for the following special cases:

(1) For engines with stop-start technology, account for accessory load during engine-off conditions by determining the total engine-off power demand over the test interval and distributing that load over the engine-on portions of the test interval based on calculated average power. You may determine the engine-off time by running practice cycles or through engineering analysis.

(2) Apply accessory loads for hybrid powertrain testing that includes the

transmission either as a mechanical or electrical load.

(3) You may apply the following deviations from specified torque settings for smoother idle (other than idle that includes motoring), or you may develop different procedures for adjusting accessory load at idle consistent with good engineering judgment:

(i) Set the reference torque to correspond to the applicable accessory load for all points with normalized speed at or below zero percent and reference torque from zero up to the torque corresponding to the accessory load.

(ii) Change the reference torques to correspond to the applicable accessory load for consecutive points with reference torques from zero up to the torque corresponding to the accessory load that immediately precedes or follows idle points.

(4) Table 1 follows:

TABLE 1 TO PARAGRAPH (c)(4) OF § 1036.514—ACCESSORY LOAD AT IDLE

Primary intended service class	Power representing accessory load (kW)
Light HDE .....	1.5
Medium HDE .....	2.5
Heavy HDE .....	3.5

(d) The test sequence consists of preconditioning the engine by running one or two FTPs with each FTP followed by (20 ±1) minutes with no engine operation and a hot start run through the LLC. You may start any preconditioning FTP with a hot engine. Perform testing as described in 40 CFR 1065.530 for a test interval that includes engine starting. Calculate the total emission mass of each constituent, *m*, and the total work, *W*, as described in 40 CFR 1065.650. Calculate total work over the test interval for powertrain testing using system power, *P<sub>sys</sub>*. Determine *P<sub>sys</sub>* using § 1036.520(f). For powertrains with automatic transmissions, account for and include the work produced by the engine from the CITT load. For batch sampling, you may sample background periodically into the bag over the course of multiple test intervals.

(e) Calculate and evaluate cycle statistics as specified in 40 CFR 1065.514 for nonhybrid engines and 40 CFR 1037.550 for hybrid engines and hybrid powertrains. For gaseous-fueled engine testing with a single-point fuel injection system, you may apply all the statistical criteria in § 1036.540(d)(3) to validate the LLC.

**§ 1036.520 Determining power and vehicle speed values for powertrain testing.**

This section describes how to determine the system peak power and continuous rated power of hybrid and nonhybrid powertrain systems and the vehicle speed for carrying out duty-cycle testing under this part and 40 CFR 1037.550.

(a) You must map or re-map an engine before a test if any of the following apply:

(1) If you have not performed an initial engine map.

(2) If the atmospheric pressure near the engine's air inlet is not within ±5 kPa of the atmospheric pressure recorded at the time of the last engine map.

(3) If the engine or emission-control system has undergone changes that might affect maximum torque performance. This includes changing the configuration of auxiliary work inputs and outputs.

(4) If you capture an incomplete map on your first attempt or you do not complete a map within the specified time tolerance. You may repeat mapping as often as necessary to capture a complete map within the specified time.

(b) Set up the powertrain test according to 40 CFR 1037.550, with the following exceptions:

(1) Use vehicle parameters, other than power, as specified in § 1036.510(b)(2). Use the applicable automatic transmission as specified in § 1036.540(c)(2).

(2) Select a manufacturer-declared value for *P<sub>contrated</sub>* to represent system peak power.

(c) Verify the following before the start of each test interval:

(1) The state-of-charge of the rechargeable energy storage system (RESS) must be at or above 90% of the operating range between the minimum and maximum RESS energy levels specified by the manufacturer.

(2) The conditions of all hybrid system components must be within their normal operating range as declared by the manufacturer, including ensuring that no features are actively limiting power or vehicle speed.

(d) Carry out the test as described in this paragraph (d). Warm up the powertrain by operating it. We recommend operating the powertrain at any vehicle speed and road grade that achieves approximately 75% of its expected maximum power. Continue the warm-up until the engine coolant, block, or head absolute temperature is within ±2% of its mean value for at least 2 min or until the engine thermostat controls engine temperature. Within 90 seconds after concluding the warm-up,

operate the powertrain over a continuous trace meeting the following specifications:

(1) Bring the vehicle speed to 0 mi/hr and let the powertrain idle at 0 mi/hr for 50 seconds.

(2) Set maximum driver demand for a full load acceleration at 6.0% road grade with an initial vehicle speed of 0 mi/hr, continuing for 268 seconds.

(3) Linearly ramp the grade from 6.0% down to 0.0% over 300 seconds. Stop the test 30 seconds after the grade setpoint has reached 0.0%.

(e) Record the powertrain system angular speed and torque values measured at the dynamometer at 100 Hz and use these in conjunction with the vehicle model to calculate vehicle system power, *P<sub>sys,vehicle</sub>*. Note that *P<sub>sys</sub>* is the corresponding value for system power at a location that represents the transmission input shaft on a conventional powertrain.

(f) Calculate the system power, *P<sub>sys</sub>*, for each data point as follows:

(1) For testing with the speed and torque measurements at the transmission input shaft, *P<sub>sys</sub>* is equal to the calculated vehicle system power, *P<sub>sys,vehicle</sub>*, determined in paragraphs (d) and (e) of this section.

(2) For testing with the speed and torque measurements at the axle input shaft or the wheel hubs, determine *P<sub>sys</sub>* for each data point using the following equation:

$$P_{sys} = \frac{P_{sys,vehicle}}{\epsilon_{trans} \cdot \epsilon_{axle}}$$

Eq. 1036.520-1

Where:

*P<sub>sys,vehicle</sub>* = the calculated vehicle system power for each 100-Hz data point.

*ε<sub>trans</sub>* = the default transmission efficiency = 0.95.

*ε<sub>axle</sub>* = the default axle efficiency. Set this value to 1 for speed and torque measurement at the axle input shaft or to 0.955 at the wheel hubs.

Example:

$$P_{sys,vehicle} = 317.6 \text{ kW}$$

$$P_{sys} = \frac{317.6}{0.95 \cdot 0.955}$$

$$P_{sys} = 350.1 \text{ kW}$$

(g) For each 200-ms (5-Hz) time step, *t*, determine the coefficient of variation (COV) of as follows:

(1) Calculate the standard deviation, *σ(t)* of the 20 100-Hz data points in each 5-Hz measurement interval using the following equation:

$$\sigma(t) = \sqrt{\frac{1}{N} \cdot \sum_{i=1}^N (P_{\text{sys}i} - \bar{P}_{\text{sys}}(t))^2}$$

Eq. 1036.520-2

Where:

$N$  = the number of data points in each 5-Hz measurement interval = 20.

$P_{\text{sys}i}$  = the 100-Hz values of  $P_{\text{sys}}$  within each 5-Hz measurement interval.

$P_{\text{sys}}(t)$  = the mean power from each 5-Hz measurement interval.

(2) Calculate the 5-Hz values for  $COV(t)$  for each time step,  $t$ , as follows:

$$COV(t) = \frac{\sigma(t)}{\bar{P}_{\text{sys}}(t)}$$

Eq. 1036.520-3

(h) Determine rated power,  $P_{\text{rated}}$ , as the maximum measured power from the data collected in paragraph (f)(2) of this section that meets the specifications in paragraph (g) of this section.

(i) Determine continuous rated power,  $P_{\text{contrated}}$ , as follows:

(1) For nonhybrid powertrains,

$P_{\text{contrated}}$  equals  $P_{\text{rated}}$ .

(2) For hybrid powertrains,  $P_{\text{contrated}}$  is the maximum measured power from the data collected in paragraph (d)(3) of this section that meets the specifications in paragraph (g) of this section.

(j) Determine vehicle C speed,  $v_{\text{refC}}$ , as follows:

(1) If the maximum  $P_{\text{sys}}(t)$  in the highest gear during the maneuver in paragraph (d)(3) of this section is greater than  $0.98 \cdot P_{\text{contrated}}$ ,  $v_{\text{refC}}$  is the average of the minimum and maximum vehicle speeds where  $P_{\text{sys}}(t)$  is equal to  $0.98 \cdot P_{\text{contrated}}$  during the maneuver in paragraph (d)(3) of this section where the transmission is in the highest gear, using linear interpolation, as appropriate.

(2) Otherwise,  $v_{\text{refC}}$  is the maximum vehicle speed during the maneuver in paragraph (d)(3) where the transmission is in the highest gear.

(k) If  $P_{\text{contrated}}$  as determined in paragraph (i) of this section is within  $\pm 3\%$  of the manufacturer-declared value for  $P_{\text{contrated}}$ , use the manufacturer-declared value. Otherwise, repeat the procedure in paragraphs (b) through (j) of this section and use  $P_{\text{contrated}}$  from paragraph (i) instead of the manufacturer-declared value.

#### § 1036.525 Clean Idle test.

Measure emissions using the procedures described in this section to determine whether engines and hybrid powertrains meet the clean idle emission standards in § 1036.104(b). For plug-in hybrid engines and powertrains,

perform the test with the hybrid function disabled.

(a) The clean idle test consists of two separate test intervals as follows:

(1) Mode 1 consists of engine operation with a speed setpoint at your recommended warm idle speed. Set the dynamometer torque demand corresponding to vehicle power requirements at your recommended warm idle speed that represent in-use operation.

(2) Mode 2 consists of engine operation with a speed setpoint at 1100 r/min. Set the dynamometer torque demand to account for the sum of the following power loads:

(i) Determine power requirements for idling at 1100 r/min.

(ii) Apply a power demand of 2 kW to account for appliances and accessories the vehicle operator may use during rest periods.

(3) Determine torque demand for testing under this paragraph (a) based on an accessory load that includes the engine cooling fan, alternator, coolant pump, air compressor, engine oil and fuel pumps, and any other engine accessory that operates at the specific test condition. Also include the accessory load from the air conditioning compressor operating at full capacity for Mode 2. Do not include any other load for air conditioning or other cab or vehicle accessories except as specified.

(b) Perform the Clean Idle test as follows:

(1) Warm up the engine by operating it over the FTP or SET duty cycle, or by operating it at any speed above peak-torque speed and at (65 to 85) % of maximum mapped power. The warm-up is complete when the engine thermostat controls engine temperature or when the engine coolant's temperature is within 2% of its mean value for at least 2 minutes.

(2) Start operating the engine in Mode 1 as soon as practical after the engine warm-up is complete.

(3) Start sampling emissions 10 minutes after reaching the speed and torque setpoints and continue emission sampling and engine operation at those setpoints. Stop emission sampling after 1200 seconds to complete the test interval.

(4) Linearly ramp the speed and torque setpoints over 5 seconds to start operating the engine in Mode 2. Sample emissions during Mode 2 as described in paragraph (b)(3) of this section.

(c) Verify that the test speed stays within  $\pm 50$  r/min of the speed setpoint throughout the test. The torque tolerance is  $\pm 2$  percent of the maximum mapped torque at the test speed. Verify that measured torque meets the torque

tolerance relative to the torque setpoint throughout the test.

(d) Calculate the mean mass emission rate of  $\text{NO}_x$ ,  $\bar{m}$ , over each test interval by calculating the total emission mass  $\bar{m}_{\text{NO}_x}$  and dividing by the total time.

#### § 1036.530 Test procedures for off-cycle testing.

(a) *General.* This section describes the measurement and calculation procedures to perform field testing and determine whether tested engines and engine families meet emission standards under subpart E of this part. Calculate mass emission rates as specified in 40 CFR part 1065, subpart G. Use good engineering judgment to adapt these procedures for simulating vehicle operation in the laboratory.

(b) *Vehicle preparation and measurement procedures.* (1) Set up the vehicle for testing with a portable emissions measurement system (PEMS) as specified in 40 CFR part 1065, subpart J.

(2) Begin emission sampling and data collection as described in 40 CFR 1065.935(c)(3) before starting the engine at the beginning of the shift-day. Start the engine only after confirming that engine coolant temperature is at or below 40 °C.

(3) Measure emissions over one or more shift-days as specified in subpart E of this part.

(4) For engines subject to compression-ignition standards, record 1 Hz measurements of ambient temperature near the vehicle.

(c) *Test Intervals.* Determine the test intervals as follows:

(1) *Spark-ignition.* Create a single test interval that covers the entire shift-day for engines subject to spark-ignition standards. The test interval starts with the first pair of consecutive data points with no exclusions as described in paragraph (c)(3) of this section after the start of the shift-day and ends with the last pair of consecutive data points with no exclusions before the end of the shift day.

(2) *Compression-ignition.* Create a series of 300 second test intervals for engines subject to compression-ignition standards (moving-average windows) as follows:

(i) Begin and end each test interval with a pair of consecutive data points with no exclusions as described in paragraph (c)(3) of this section. Select the last data point of each test interval such that the test interval includes 300 seconds of data with no exclusions, as described in paragraph (d) of this section. The test interval may be a fraction of a second more or less than 300 seconds to account for the precision

of the time stamp in recording 1 Hz data. A test interval may include up to 599 seconds of data with continuous exclusions; invalidate any test interval that includes at least 600 seconds of continuous sampling with excluded data.

(ii) The first 300 second test interval starts with the first pair of consecutive data points with no exclusions. Determine the start of each subsequent 300 second test interval by finding the first pair of consecutive data points with no exclusions after the initial data point of the previous test interval.

(iii) The last 300 second test interval ends with the last pair of consecutive data points with no exclusions before the end of the shift day.

(3) *Excluded data.* Exclude data from test intervals for any period meeting one or more of the following conditions:

(i) An analyzer or flow meter is performing zero and span drift checks or zero and span calibrations, including any time needed for the analyzer to stabilize afterward, consistent with good engineering judgment.

(ii) The engine is off, except as specified in § 1036.415(g).

(iii) The engine is performing an infrequent regeneration. Do not exclude data related to any other AECs, except as specified in paragraph (c)(3)(vi) of this section.

(iv) The recorded ambient air temperature is below 5 °C or above the temperature calculated using the following equation.

$$T_{\max} = -0.0014 \cdot h + 37.78$$

Eq. 1036.530-1

Where:

$h$  = recorded elevation of the vehicle in feet above sea level ( $h$  is negative for elevations below sea level).

*Example:*

$h = 2679$  ft  
 $T_{\max} = -0.0014 \cdot 2679 + 37.78$   
 $T_{\max} = 34.0$  °C

(v) The vehicle is operating at an elevation more than 5,500 feet above sea level.

(vi) An engine has one or more active AECs for emergency vehicles under § 1036.115(h)(4).

(vii) A single data point does not meet any of the conditions specified in paragraphs (c)(3)(i) through (vi) of this section, but it is preceded and followed by data points that both meet one or more of the specified exclusion conditions.

(d) *Assembling test intervals.* A test interval may include multiple subintervals separated by periods with one or more exclusions under paragraph (c)(3) of this section.

(1) Treat these test subintervals as continuous for calculating duration of

the test interval for engines subject to compression-ignition standards.

(2) Calculate emission mass during each test subinterval and sum those subinterval emission masses to determine the emission mass over the test interval. Calculate emission mass as described in 40 CFR 1065.650(c)(2)(i), with the following exceptions and clarifications:

(i) Correct NO<sub>x</sub> emissions for humidity as specified in 40 CFR 1065.670. Calculate corrections relative to ambient air humidity as measured by PEMS.

(ii) Disregard the provision in 40 CFR 1065.650(g) for setting negative emission mass to zero for test intervals and subintervals.

(iii) Calculation of emission mass in 40 CFR 1065.650 assumes a constant time interval,  $\Delta t$ . If it is not appropriate to assume  $\Delta t$  is constant for testing under this section, use good engineering judgment to record time at each data point and adjust the mass calculation from Eq. 1065.650-4 by treating  $\Delta t$  as a variable.

(e) *Normalized CO<sub>2</sub> emission mass over a 300 second test interval.* For engines subject to compression-ignition standards, determine the normalized CO<sub>2</sub> emission mass over each 300 second test interval,  $m_{CO_2, norm, testinterval}$ , to the nearest 0.01% using the following equation:

$$m_{CO_2, norm, testinterval} = \frac{m_{CO_2, testinterval}}{e_{CO_2 FTPFCL} \cdot P_{\max} \cdot t_{testinterval}}$$

Eq. 1036.530-2

Where:

$m_{CO_2, testinterval}$  = total CO<sub>2</sub> emission mass over the test interval.

$e_{CO_2 FTPFCL}$  = the engine's FCL for CO<sub>2</sub> over the FTP duty cycle. If the engine family

includes no FTP testing, use the engine's FCL for CO<sub>2</sub> over the SET duty cycle.

$P_{\max}$  = the highest value of rated power for all the configurations included in the engine family.

$t_{testinterval}$  = duration of the test interval. Note that the nominal value is 300 seconds.

*Example:*

$m_{CO_2, testinterval} = 3948$  g  
 $e_{CO_2 FTPFCL} = 428.2$  g/hp·hr  
 $P_{\max} = 406.5$  hp  
 $t_{testinterval} = 300.01$  s = 0.08 hr

$$m_{CO_2, norm, testinterval} = \frac{3948}{428.2 \cdot 406.5 \cdot 0.08}$$

$m_{CO_2, norm, testinterval} = 0.2722 = 27.22\%$

(f) *Binning 300 second test intervals.* For engines subject to compression-ignition standards, identify the appropriate bin for each of the 300 second test intervals based on its normalized CO<sub>2</sub> emission mass,  $m_{CO_2, norm, testinterval}$ , as follows:

TABLE 1 TO PARAGRAPH (f) OF § 1036.530—CRITERIA FOR OFF-CYCLE BINS

Bin	Normalized CO <sub>2</sub> emission mass over the 300 second test interval
Bin 1 ....	$m_{CO_2, norm, testinterval} \leq 6.00\%$ .
Bin 2 ....	$m_{CO_2, norm, testinterval} > 6.00\%$ .

(g) *Off-cycle emissions quantities.* Determine the off-cycle emissions quantities as follows:

(1) *Spark-ignition.* For engines subject to spark-ignition standards, the off cycle emission quantity,  $e_{[emission], offcycle}$ , is the value for CO<sub>2</sub>-specific emission mass for a given pollutant over the test interval representing the shift-day converted to a brake-specific value, as calculated for

each measured pollutant using the following equation:

$$e_{[emissions],offcycle} = \frac{m_{[emission]}}{m_{CO_2}} \cdot e_{CO_2FTPFCFL}$$

Eq. 1036.530-3

Where:

$m_{[emission]}$  = total emission mass for a given pollutant over the test interval as determined in paragraph (d)(2) of this section.  
 $m_{CO_2}$  = total CO<sub>2</sub> emission mass over the test interval as determined in paragraph (d)(2) of this section.  
 $e_{CO_2FTPFCFL}$  = the engine's FCL for CO<sub>2</sub> over the FTP duty cycle.

Example:

$m_{NO_x} = 1.337$  g

$m_{CO_2} = 18778$  g

$e_{CO_2FTPFCFL} = 505.1$  g/hp-hr

$$e_{NO_x,offcycle} = \frac{1.337}{18778} \cdot 505.1$$

$e_{NO_x,offcycle} = 0.035$  g/hp-hr

(2) *Compression-ignition.* For engines subject to compression-ignition standards, determine the off-cycle emission quantity for each bin. When calculating mean bin emissions from ten

engines to apply the pass criteria for engine families in § 1036.425(c), set any negative off-cycle emissions quantity to zero before calculating mean bin emissions.

(i) *Off-cycle emissions quantity for bin 1.* The off-cycle emission quantity for bin 1,  $\bar{m}_{NO_x,offcycle,bin1}$ , is the mean NO<sub>x</sub> mass emission rate from all test intervals associated with bin 1 as calculated using the following equation:

$$\bar{m}_{NO_x,offcycle,bin1} = \frac{\sum_{i=1}^N m_{NO_x,testinterval,i}}{\sum_{i=1}^N t_{testinterval,i}}$$

Eq. 1036.530-4

Where:

$i$  = an indexing variable that represents one 300 second test interval.  
 $N$  = total number of 300 second test intervals in bin 1.  
 $m_{NO_x,testinterval,i}$  = total NO<sub>x</sub> emission mass over the test interval  $i$  in bin 1 as

determined in paragraph (d)(2) of this section.  
 $t_{testinterval,i}$  = total time of test interval  $i$  in bin 1 as determined in paragraph (d)(1) of this section. Note that the nominal value is 300 seconds.

Example:

$N = 10114$

$m_{NO_x,testinterval,1} = 0.021$  g

$m_{NO_x,testinterval,2} = 0.025$  g

$m_{NO_x,testinterval,3} = 0.031$  g

$t_{testinterval,1} = 299.99$  s

$t_{testinterval,2} = 299.98$  s

$t_{testinterval,3} = 300.04$  s

$$\bar{m}_{NO_x,offcycle,bin1} = \frac{(0.021 + 0.025 + 0.031 \dots + m_{NO_x,testinterval,10114})}{(299.99 + 299.98 + 300.04 \dots + t_{testinterval,10114})}$$

$\bar{m}_{NO_x,offcycle,bin1} = 0.000285$  g/s = 1.026 g/hr

(ii) *Off-cycle emissions quantity for bin 2.* The off-cycle emission quantity

for bin 2,  $e_{[emission],offcycle,bin2}$ , is the value for CO<sub>2</sub>-specific emission mass for a given pollutant of all the 300 second test intervals in bin 2 combined and

converted to a brake-specific value, as calculated for each measured pollutant using the following equation:

$$e_{[emissions],offcycle,bin2} = \frac{\sum_{i=1}^N m_{[emission],testinterval,i}}{\sum_{i=1}^N m_{CO_2,testinterval,i}} \cdot e_{CO_2FTPFCFL}$$

Eq. 1036.530-5

Where:

$i$  = an indexing variable that represents one 300 second test interval.  
 $N$  = total number of 300 second test intervals in bin 2.  
 $m_{[emission],testinterval,i}$  = total emission mass for a given pollutant over the test interval  $i$  in bin 2 as determined in paragraph (d)(2) of this section.

$m_{CO_x,testinterval,i}$  = total CO<sub>2</sub> emission mass over the test interval  $i$  in bin 2 as determined in paragraph (d)(2) of this section.  
 $e_{CO_2FTPFCFL}$  = the engine's FCL for CO<sub>2</sub> over the FTP duty cycle.

Example:

$N = 15439$

$m_{NO_x1} = 0.546$  g

$m_{NO_x2} = 0.549$  g

$m_{NO_x3} = 0.556$  g

$m_{CO_x1} = 10950.2$  g

$m_{CO_x2} = 10961.3$  g

$m_{CO_x3} = 10965.3$  g

$e_{CO_x FTPFCFL} = 428.1$  g/hp-hr



$$e_{\text{NOx,offcycle,bin2}} = \frac{(0.546 + 0.549 + 0.556 \dots + m_{\text{NOx,testinterval,15439}})}{(10950.2 + 10961.3 + 10965.3 \dots + m_{\text{CO2,testinterval,15439}})} \cdot 428.1$$

$e_{\text{NOx,offcycle,bin2}} = 0.026 \text{ g/hp-hr}$

(h) *Shift-day ambient temperature.*

For engines subject to compression-ignition standards, determine the mean shift-day ambient temperature,  $T_{\text{amb}}$ , considering only temperature readings corresponding to data with no exclusions under paragraph (c)(3) of this section.

(i) *Graphical illustration.* Figure 1 of this section illustrates a test interval

with interruptions of one or more data points excluded under paragraph (c)(3) of this section. The x-axis is time and the y-axis is the mass emission rate at each data point,  $\dot{m}(t)$ . The data points coincident with any exclusion are illustrated with open circles. The shaded area corresponding to each group of closed circles represents the total emission mass over that test subinterval. Note that negative values of

$\dot{m}(t)$  are retained and not set to zero in the numerical integration calculation. The first group of data points without any exclusions is referred to as the first test subinterval and so on.

**Figure 1 to Paragraph (i) of § 1036.530—Illustration of Integration of Mass of Emissions Over a Test Interval With Exclude Data Points**

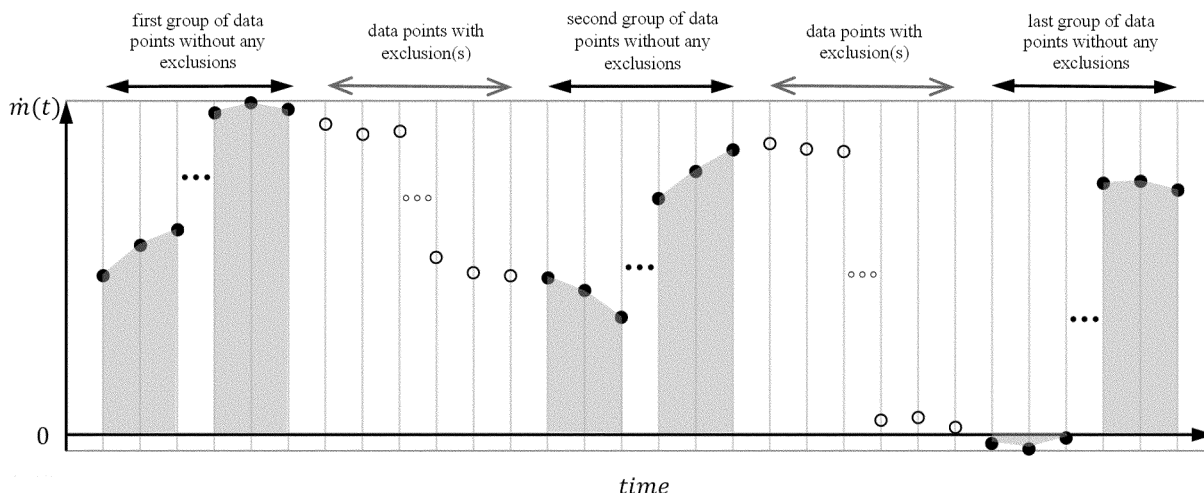

**§ 1036.535 Determining steady-state engine fuel maps and fuel consumption at idle.**

The procedures in this section describe how to determine an engine's steady-state fuel map and fuel consumption at idle for model year 2021 and later vehicles; these procedures apply as described in § 1036.505. Vehicle manufacturers may need these values to demonstrate compliance with emission standards under 40 CFR part 1037.

(a) *General test provisions.* Perform fuel mapping using the procedure described in paragraph (b) of this section to establish measured fuel-consumption rates at a range of engine speed and load settings. Measure fuel consumption at idle using the procedure described in paragraph (c) of this section. Paragraph (d) of this section describes how to apply the steady-state mapping from paragraph (b) of this section for the special case of cycle-average mapping for highway cruise cycles as described in § 1036.540. Use these measured fuel-consumption values to declare fuel-consumption rates for certification as described in paragraph (g) of this section.

(1) Map the engine's torque curve and declare engine idle speed as described in § 1036.505(c)(1) and (3). Perform emission measurements as described in 40 CFR 1065.501 and 1065.530 for discrete-mode steady-state testing. This section uses engine parameters and variables that are consistent with 40 CFR part 1065.

(2) Measure NO<sub>x</sub> emissions as described in paragraph (f) of this section. Include these measured NO<sub>x</sub> values any time you report to us your fuel consumption values from testing under this section.

(3) You may use shared data across engine configurations to the extent that the fuel-consumption rates remain valid.

(4) The provisions related to carbon balance error verification in § 1036.543 apply for all testing in this section. These procedures are optional, but we will perform carbon balance error verification for all testing under this section.

(5) Correct fuel mass flow rate to a mass-specific net energy content of a reference fuel as described in paragraph (e) of this section.

(b) *Steady-state fuel mapping.* Determine steady-state fuel-consumption rates for each engine configuration over a series of paired engine speed and torque setpoints as described in this paragraph (b). For example, if you test a high-output (parent) configuration and create a different (child) configuration that uses the same fueling strategy but limits the engine operation to be a subset of that from the high-output configuration, you may use the fuel-consumption rates for the reduced number of mapped points for the low-output configuration, as long as the narrower map includes at least 70 points. Perform fuel mapping as follows:

(1) Generate the fuel-mapping sequence of engine speed and torque setpoints as follows:

(i) Select the following required speed setpoints: warm idle speed,  $f_{\text{idle}}$  the highest speed above maximum power at which 70% of maximum power occurs,  $n_{\text{hi}}$ , and eight (or more) equally spaced points between  $f_{\text{idle}}$  and  $n_{\text{hi}}$ . (See 40 CFR 1065.610(c)). For engines with adjustable warm idle speed, replace  $f_{\text{idle}}$  with minimum warm idle speed  $f_{\text{idlemin}}$ .

(ii) Determine the following default torque setpoints at each of the selected

speed setpoints: zero ( $T = 0$ ), maximum mapped torque,  $T_{\max \text{ mapped}}$ , and eight (or more) equally spaced points between  $T = 0$  and  $T_{\max \text{ mapped}}$ . Select the maximum torque setpoint at each speed to conform to the torque map as follows:

(A) Calculate 5 percent of  $T_{\max \text{ mapped}}$ . Subtract this result from the mapped torque at each speed setpoint,  $T_{\max}$ .

(B) Select  $T_{\max}$  at each speed setpoint as a single torque value to represent all the default torque setpoints above the value determined in paragraph (b)(1)(ii)(A) of this section. All the default torque setpoints less than  $T_{\max}$  at a given speed setpoint are required torque setpoints.

(iii) You may select any additional speed and torque setpoints consistent with good engineering judgment. For example you may need to select additional points if the engine's fuel

consumption is nonlinear across the torque map. Avoid creating a problem with interpolation between narrowly spaced speed and torque setpoints near  $T_{\max}$ . For each additional speed setpoint, we recommend including a torque setpoint of  $T_{\max}$ ; however, you may select torque setpoints that properly represent in-use operation. Increments for torque setpoints between these minimum and maximum values at an additional speed setpoint must be no more than one-ninth of  $T_{\max \text{ mapped}}$ . Note that if the test points were added for the child rating, they should still be reported in the parent fuel map. We will test with at least as many points as you. If you add test points to meet testing requirements for child ratings, include those same test points as reported values for the parent fuel map. For our testing, we will use the same

normalized speed and torque test points you use, and we may select additional test points.

(iv) Start fuel-map testing at the highest speed setpoint and highest torque setpoint, followed by decreasing torque setpoints at the highest speed setpoint. Continue testing at the next lowest speed setpoint and the highest torque setpoint at that speed setpoint, followed by decreasing torque setpoints at that speed setpoint. Follow this pattern through all the speed and torque points, ending with the lowest speed ( $f_{\text{idle}}$  or  $f_{\text{idlemin}}$ ) and torque setpoint ( $T = 0$ ). The following figure illustrates an array of test points and the corresponding run order.

**Figure 1 to Paragraph (b)(1)(iv) of § 1036.535—Illustration of Steady-State Fuel-Mapping Test Points and Run Order**

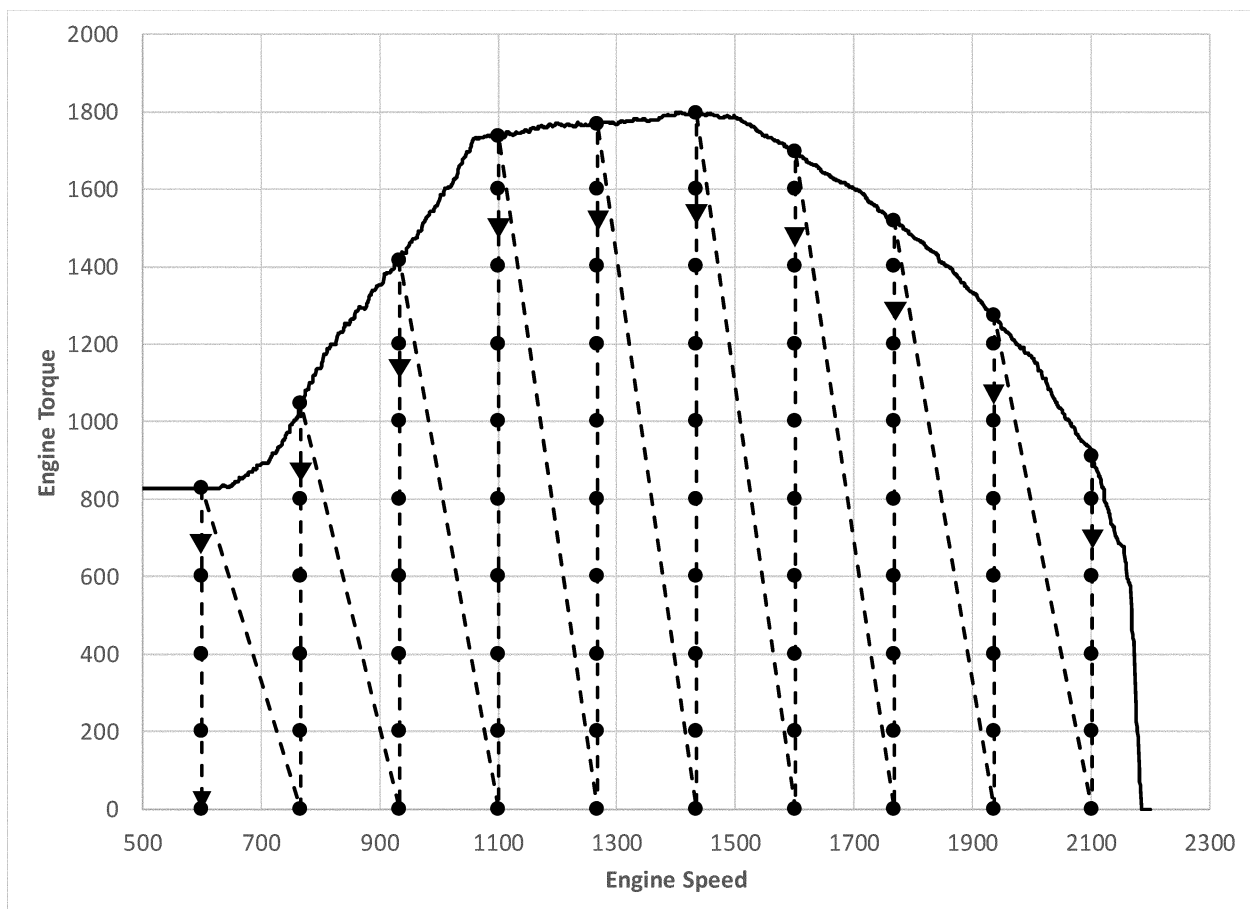

(v) The highest torque setpoint for each speed setpoint is an optional reentry point to restart fuel mapping after an incomplete test run.

(vi) The lowest torque setpoint at each speed setpoint is an optional exit point to interrupt testing. Paragraph (b)(7) of

this section describes how to interrupt testing at other times.

(2) If the engine's warm idle speed is adjustable, set it to its minimum value,  $f_{\text{idlemin}}$ .

(3) The measurement at each unique combination of speed and torque setpoints constitutes a test interval.

Unless we specify otherwise, you may program the dynamometer to control either speed or torque for a given test interval, with operator demand controlling the other parameter. Control speed and torque so that all recorded speed points are within  $\pm 1\%$  of  $n_{hi}$  from the target speed and all recorded engine

torque points are within  $\pm 5\%$  of  $T_{\max}$  mapped from the target torque during each test interval, except as follows:

(i) For steady-state engine operating points that cannot be achieved, and the operator demand stabilizes at minimum; program the dynamometer to control torque and let the engine govern speed (see 40 CFR 1065.512(b)(1)). Control torque so that all recorded engine torque points are within  $\pm 25$  N·m from the target torque. The specified speed tolerance does not apply for the test interval.

(ii) For steady-state engine operating points that cannot be achieved and the operator demand stabilizes at maximum and the speed setpoint is below 90% of  $n_{hi}$  even with maximum operator demand, program the dynamometer to control speed and let the engine govern torque (see 40 CFR 1065.512(b)(2)). The specified torque tolerance does not apply for the test interval.

(iii) For steady-state engine operating points that cannot be achieved and the operator demand stabilizes at maximum and the speed setpoint is at or above 90% of  $n_{hi}$  even with maximum operator demand, program the dynamometer to control torque and let the engine govern speed (see 40 CFR 1065.512(b)(1)). The specified speed tolerance does not apply for the test interval.

(iv) For the steady-state engine operating points at the minimum speed setpoint and maximum torque setpoint, you may program the dynamometer to control speed and let the engine govern torque. The specified torque tolerance does not apply for this test interval if operator demand stabilizes at its maximum or minimum limit.

(4) Record measurements using direct and/or indirect measurement of fuel flow as follows:

(i) *Direct fuel-flow measurement.* Record speed and torque and measure fuel consumption with a fuel flow meter for  $(30 \pm 1)$  seconds. Determine the corresponding mean values for the test interval. Use of redundant direct fuel-flow measurements requires our advance approval.

(ii) *Indirect fuel-flow measurement.* Record speed and torque and measure

emissions and other inputs needed to run the chemical balance in 40 CFR 1065.655(c) for  $(30 \pm 1)$  seconds. Determine the corresponding mean values for the test interval. Use of redundant indirect fuel-flow measurements requires our advance approval. Measure background concentration as described in 40 CFR 1065.140, except that you may use one of the following methods to apply a single background reading to multiple test intervals:

(A) For batch sampling, you may sample periodically into the bag over the course of multiple test intervals and read them as allowed in paragraph (b)(7)(i) of this section. You must determine a single background reading for all affected test intervals if you use the method described in this paragraph (b)(4)(ii)(A).

(B) You may measure background concentration by sampling from the dilution air during the interruptions allowed in paragraph (b)(7)(i) of this section or at other times before or after test intervals. Measure background concentration within 30 minutes before the first test interval and within 30 minutes before each reentry point. Measure the corresponding background concentration within 30 minutes after each exit point and within 30 minutes after the final test interval. You may measure background concentration more frequently. Correct measured emissions for test intervals between a pair of background readings based on the average of those two values. Once the system stabilizes, collect a background sample over an averaging period of at least 30 seconds.

(5) Warm up the engine as described in 40 CFR 1065.510(b)(2). Within 60 seconds after concluding the warm-up, linearly ramp the speed and torque setpoints over 5 seconds to the starting test point from paragraph (b)(1) of this section.

(6) Stabilize the engine by operating at the specified speed and torque setpoints for  $(70 \pm 1)$  seconds and then start the test interval. Record measurements during the test interval. Measure and report  $\text{NO}_x$  emissions over each test

interval as described in paragraph (f) of this section.

(7) After completing a test interval, linearly ramp the speed and torque setpoints over 5 seconds to the next test point.

(i) You may interrupt the fuel-mapping sequence before a reentry point as noted in paragraphs (b)(1)(v) and (vi) of this section. If you zero and span analyzers, read and evacuate background bag samples, or sample dilution air for a background reading during the interruption, the maximum time to stabilize in paragraph (b)(6) of this section does not apply. If you shut off the engine, restart with engine warm-up as described in paragraph (b)(5) of this section.

(ii) You may interrupt the fuel-mapping sequence at a given speed setpoint before completing measurements at that speed. If this happens, you may measure background concentration and take other action as needed to validate test intervals you completed before the most recent reentry point. Void all test intervals after the last reentry point. Restart testing at the appropriate reentry point in the same way that you would start a new test. Operate the engine long enough to stabilize aftertreatment thermal conditions, even if it takes more than 70 seconds. In the case of an infrequent regeneration event, interrupt the fuel-mapping sequence and allow the regeneration event to finish with the engine operating at a speed and load that allows effective regeneration.

(iii) If you void any one test interval, all the testing at that speed setpoint is also void. Restart testing by repeating the fuel-mapping sequence as described in this paragraph (b); include all voided speed setpoints and omit testing at speed setpoints that already have a full set of valid results.

(8) If you determine fuel-consumption rates using emission measurements from the raw or diluted exhaust, calculate the mean fuel mass flow rate,  $\bar{m}_{\text{fuel}}$ , for each point in the fuel map using the following equation:

$$\bar{m}_{\text{fuel}} = \frac{M_C}{w_{C\text{meas}}} \cdot \left( \bar{n}_{\text{exh}} \cdot \frac{\bar{x}_{C\text{combdry}}}{1 + \bar{x}_{\text{H}_2\text{Oexhdry}}} - \frac{\bar{m}_{\text{CO}_2\text{DEF}}}{M_{\text{CO}_2}} \right)$$

Eq. 1036.535-1

Where:

$\bar{m}_{\text{fuel}}$  = mean fuel mass flow rate for a given fuel map setpoint, expressed to at least the nearest 0.001 g/s.

$M_C$  = molar mass of carbon.

$w_{C\text{meas}}$  = carbon mass fraction of fuel (or mixture of test fuels) as determined in 40 CFR 1065.655(d), except that you may not use the default properties in Table 2 of 40 CFR 1065.655 to determine  $\alpha$ ,  $\beta$ ,

and  $w_C$ . You may not account for the contribution to  $\alpha$ ,  $\beta$ ,  $\gamma$ , and  $\delta$  of diesel exhaust fluid or other non-fuel fluids injected into the exhaust.

$\bar{n}_{\text{exh}}$  = the mean raw exhaust molar flow rate from which you measured emissions according to 40 CFR 1065.655.

$\bar{x}_{\text{Ccombdry}}$  = the mean concentration of carbon from fuel and any injected fluids in the exhaust per mole of dry exhaust as determined in 40 CFR 1065.655(c).

$\bar{x}_{\text{H}_2\text{Oexhdry}}$  = the mean concentration of  $\text{H}_2\text{O}$  in exhaust per mole of dry exhaust as determined in 40 CFR 1065.655(c).

$\bar{m}_{\text{CO}_2\text{DEF}}$  = the mean  $\text{CO}_2$  mass emission rate resulting from diesel exhaust fluid decomposition as determined in paragraph (b)(9) of this section. If your engine does not use diesel exhaust fluid, or if you choose not to perform this correction, set  $\bar{m}_{\text{CO}_2\text{DEF}}$  equal to 0.

$M_{\text{CO}_2}$  = molar mass of carbon dioxide.

*Example:*

$$M_{\text{C}} = 12.0107 \text{ g/mol}$$

$$w_{\text{Cmeas}} = 0.869$$

$$\bar{n}_{\text{exh}} = 25.534 \text{ mol/s}$$

$$\bar{x}_{\text{Ccombdry}} = 0.002805 \text{ mol/mol}$$

$$\bar{x}_{\text{H}_2\text{Oexhdry}} = 0.0353 \text{ mol/mol}$$

$$\bar{m}_{\text{CO}_2\text{DEF}} = 0.0726 \text{ g/s}$$

$$M_{\text{CO}_2} = 44.0095 \text{ g/mol}$$

$$\bar{m}_{\text{fuel}} = \frac{12.0107}{0.869} \cdot \left( 25.534 \cdot \frac{0.002805}{1 + 0.0353} - \frac{0.0726}{44.0095} \right)$$

$$\bar{m}_{\text{fuel}} = 0.933 \text{ g/s}$$

(9) If you determine fuel-consumption rates using emission measurements with engines that utilize diesel exhaust fluid

for  $\text{NO}_x$  control and you correct for the mean  $\text{CO}_2$  mass emission rate resulting from diesel exhaust fluid decomposition as described in paragraph (b)(8) of this

section, perform this correction at each fuel map setpoint using the following equation:

$$\bar{m}_{\text{CO}_2\text{DEF}} = \bar{m}_{\text{DEF}} \cdot \frac{M_{\text{CO}_2} \cdot w_{\text{CH}_4\text{N}_2\text{O}}}{M_{\text{CH}_4\text{N}_2\text{O}}}$$

Eq. 1036.535-2

Where:

$\bar{m}_{\text{DEF}}$  = the mean mass flow rate of injected urea solution diesel exhaust fluid for a given sampling period, determined directly from the ECM, or measured separately, consistent with good engineering judgment.

$M_{\text{CO}_2}$  = molar mass of carbon dioxide.

$w_{\text{CH}_4\text{N}_2\text{O}}$  = mass fraction of urea in diesel exhaust fluid aqueous solution. Note that the subscript "CH<sub>4</sub>N<sub>2</sub>O" refers to urea as a pure compound and the subscript "DEF" refers to the aqueous urea diesel exhaust fluid as a solution of urea in water. You may use a default value of 32.5% or use good engineering judgment

to determine this value based on measurement.

$M_{\text{CH}_4\text{N}_2\text{O}}$  = molar mass of urea.

*Example:*

$$\bar{m}_{\text{DEF}} = 0.304 \text{ g/s}$$

$$M_{\text{CO}_2} = 44.0095 \text{ g/mol}$$

$$w_{\text{CH}_4\text{N}_2\text{O}} = 32.5\% = 0.325$$

$$M_{\text{CH}_4\text{N}_2\text{O}} = 60.05526 \text{ g/mol}$$

$$\bar{m}_{\text{CO}_2\text{DEF}} = 0.304 \cdot \frac{44.0095 \cdot 0.325}{60.05526}$$

$$\bar{m}_{\text{CO}_2\text{DEF}} = 0.0726 \text{ g/s}$$

(10) Correct the measured or calculated mean fuel mass flow rate, at each of the engine-idle operating points to account for mass-specific net energy content as described in paragraph (e) of this section.

(c) *Fuel consumption at idle.*

Determine fuel-consumption rates at idle for each engine configuration that is certified for installation in vocational vehicles. Determine fuel-consumption rates at idle by testing engines over a series of paired engine speed and torque setpoints as described in this paragraph (c). Perform measurements as follows:

(1) The idle test sequence consists of measuring fuel consumption at four test points representing each combination of the following speed and torque setpoints in any order.

(i) Speed setpoints for engines with adjustable warm idle speed are minimum warm idle speed,  $f_{\text{idlemin}}$ , and maximum warm idle speed,  $f_{\text{idlemax}}$ . Speed setpoints for engines with no

adjustable warm idle speed (with zero torque on the primary output shaft) are  $f_{\text{idle}}$  and 1.15 times  $f_{\text{idle}}$ .

(ii) Torque setpoints are 0 and 100 N·m.

(2) Control speed and torque as follows:

(i) *Adjustable warm idle speed.* Set the engine's warm idle speed to the next speed setpoint any time before the engine reaches the next test point. Control both speed and torque when the engine is warming up and when it is transitioning to the next test point. Start to control both speed and torque. At any time prior to reaching the next engine-idle operating point, set the engine's adjustable warm idle speed setpoint to the speed setpoint of the next engine-idle operating point in the sequence. This may be done before or during the warm-up or during the transition. Near the end of the transition period control speed and torque as described in paragraph (b)(3)(i) of this section shortly before reaching each test point. Once the engine is operating at the desired

speed and torque setpoints, set the operator demand to minimum; control torque so that all recorded engine torque points are within  $\pm 25$  N·m from the target torque.

(ii) *Nonadjustable warm idle speed.*

For the lowest speed setpoint, control speed and torque as described in paragraph (c)(2)(i) of this section, except for adjusting the warm idle speed. For the second-lowest speed setpoint, control speed and torque so that all recorded speed points are within  $\pm 1\%$  of  $n_{\text{hi}}$  from the target speed and engine torque within  $\pm 5\%$  of  $T_{\text{max}}$  mapped from the target torque.

(3) Record measurements using direct and/or indirect measurement of fuel flow as follows:

(i) *Direct fuel flow measurement.*

Record speed and torque and measure fuel consumption with a fuel flow meter for  $(600 \pm 1)$  seconds. Determine the corresponding mean values for the test interval. Use of redundant direct fuel-flow measurements require prior EPA approval.

(ii) *Indirect fuel flow measurement.* Record speed and torque and measure emissions and other inputs needed to run the chemical balance in 40 CFR 1065.655(c) for (600 ±1) seconds. Determine the corresponding mean values for the test interval. Use of redundant indirect fuel-flow measurements require prior EPA approval. Measure background concentration as described in paragraph (b)(4)(ii) of this section. We recommend setting the CVS flow rate as low as possible to minimize background, but without introducing errors related to insufficient mixing or other operational considerations. Note that for this testing 40 CFR 1065.140(e) does not apply, including the minimum dilution ratio of 2:1 in the primary dilution stage.

(4) Warm up the engine as described in 40 CFR 1065.510(b)(2). Within 60 seconds after concluding the warm-up, linearly ramp the speed and torque over 20 seconds to the first speed and torque setpoint.

(5) The measurement at each unique combination of speed and torque setpoints constitutes a test interval. Operate the engine at the selected speed and torque set points for (180 ±1)

seconds, and then start the test interval. Record measurements during the test interval. Measure and report NO<sub>x</sub> emissions over each test interval as described in paragraph (f) of this section.

(6) After completing each test interval, repeat the steps in paragraphs (c)(4) and (5) of this section for all the remaining engine-idle test points.

(7) Each test point represents a stand-alone measurement. You may therefore take any appropriate steps between test intervals to process collected data and to prepare engines and equipment for further testing. Note that the allowances for combining background in paragraph (b)(4)(ii)(B) of this section do not apply. If an infrequent regeneration event occurs, allow the regeneration event to finish; void the test interval if the regeneration starts during a measurement.

(8) Correct the measured or calculated mean fuel mass flow rate, at each of the engine-idle operating points to account for mass-specific net energy content as described in paragraph (e) of this section.

(d) *Steady-state fuel maps used for cycle-average fuel mapping of the*

*highway cruise cycles.* Determine steady-state fuel-consumption rates for each engine configuration over a series of paired engine speed and torque setpoints near idle as described in this paragraph (d). Perform fuel mapping as described in paragraph (b) of this section with the following exceptions:

(1) Select speed setpoints to cover a range of values to represent in-use operation at idle. Speed setpoints for engines with adjustable warm idle speed must include at least minimum warm idle speed,  $f_{idlemin}$ , and a speed at or above maximum warm idle speed,  $f_{idlemax}$ . Speed setpoints for engines with no adjustable idle speed must include at least warm idle speed (with zero torque on the primary output shaft),  $f_{idle}$ , and a speed at or above 1.15 ·  $f_{idle}$ .

(2) Select the following torque setpoints at each speed setpoint to cover a range of values to represent in-use operation at idle:

(i) The minimum torque setpoint is zero.

(ii) Choose a maximum torque setpoint that is at least as large as the value determined by the following equation:

$$T_{idlemaxest} = \left( \frac{T_{finstall} \cdot f_{idle}^2}{f_{finstall}^2} + \frac{P_{acc}}{f_{idle}} \right) \cdot 1.1$$

Eq. 1036.535-3

Where:

$T_{finstall}$  = the maximum engine torque at  $f_{finstall}$ .  
 $f_{idle}$  = for engines with an adjustable warm idle speed, use the maximum warm idle speed,  $f_{idlemax}$ . For engines without an adjustable warm idle speed, use warm idle speed,  $f_{idle}$ .

$f_{finstall}$  = the stall speed of the torque converter; use  $f_{fntest}$  or 2250 r/min, whichever is lower.

$P_{acc}$  = accessory power for the vehicle class; use 1500 W for Vocational Light HDV, 2500 W for Vocational Medium HDV, and 3500 W for Tractors and Vocational Heavy HDV. If your engine is going to be installed in multiple vehicle classes, perform the test with the accessory

power for the largest vehicle class the engine will be installed in.

*Example:*

$T_{finstall} = 1870 \text{ N}\cdot\text{m}$   
 $f_{fntest} = 1740.8 \text{ r/min} = 182.30 \text{ rad/s}$   
 $f_{finstall} = 1740.8 \text{ r/min} = 182.30 \text{ rad/s}$   
 $f_{idle} = 700 \text{ r/min} = 73.30 \text{ rad/s}$   
 $P_{acc} = 1500 \text{ W}$

$$T_{idlemaxest} = \left( \frac{1870 \cdot 73.30^2}{182.30^2} + \frac{1500}{73.30} \right) \cdot 1.1$$

$T_{idlemaxest} = 355.07 \text{ N}\cdot\text{m}$

(iii) Select one or more equally spaced intermediate torque setpoints, as needed, such that the increment between torque setpoints is no greater than one-ninth of  $T_{max,mapped}$ .

(e) *Correction for net energy content.* Correct the measured or calculated mean fuel mass flow rate,  $\bar{m}_{fuel}$ , for each test interval to a mass-specific net energy content of a reference fuel using the following equation:

$$\bar{m}_{fuelcor} = \bar{m}_{fuel} \cdot \frac{E_{mfuelmeas}}{E_{mfuelCref} \cdot W_{Cref}}$$

Eq. 1036.535-4

Where:

$E_{mfuelmeas}$  = the mass-specific net energy content of the test fuel as determined in § 1036.550(b)(1).

$E_{mfuelCref}$  = the reference value of carbon-mass-specific net energy content for the appropriate fuel. Use the values shown in Table 1 in § 1036.550 for the designated fuel types, or values we approve for other fuel types.

$W_{Cref}$  = the reference value of carbon mass fraction for the test fuel as shown in Table 1 of § 1036.550 for the designated fuels. For any fuel not identified in the table, use the reference carbon mass fraction of diesel fuel for engines subject to compression-ignition standards, and use the reference carbon mass fraction of gasoline for engines subject to spark-ignition standards.

*Example:*

$\bar{m}_{fuel} = 0.933 \text{ g/s}$   
 $E_{mfuelmeas} = 42.7984 \text{ MJ/kgC}$   
 $E_{mfuelCref} = 49.3112 \text{ MJ/kgC}$

$w_{Cref} = 0.874$

$$\bar{m}_{fuel} = 0.933 \cdot \frac{42.7984}{49.3112 \cdot 0.874}$$

$\bar{m}_{fuel} = 0.927 \text{ g/s}$

(f) *Measuring NO<sub>x</sub> emissions.* Measure NO<sub>x</sub> emissions for each sampling period in g/s. You may perform these measurements using a NO<sub>x</sub> emission-measurement system that meets the requirements of 40 CFR part 1065, subpart J. If a system malfunction prevents you from measuring NO<sub>x</sub> emissions during a test under this section but the test otherwise gives valid results, you may consider this a valid test and omit the NO<sub>x</sub> emission measurements; however, we may require you to repeat the test if we determine that you inappropriately voided the test with respect to NO<sub>x</sub> emission measurement.

(g) *Measured vs. declared fuel consumption.* Determine declared fuel consumption as follows:

(1) Select fuel consumption rates in g/s to characterize the engine's fuel maps. You must select a declared value for each test point that is at or above the corresponding value determined in paragraphs (b) through (d) of this section, including those from redundant measurements.

(2) Declared fuel consumption serves as emission standards under § 1036.108. These are the values that vehicle manufacturers will use for certification under 40 CFR part 1037. Note that production engines are subject to GEM cycle-weighted limits as described in § 1036.301.

(3) If you perform the carbon balance error verification, select declared values that are at or above the following emission measurements:

(i) If you pass the  $\epsilon_{c}$  verification, you may use the average of the values from direct and indirect fuel measurements.

(ii) If you fail  $\epsilon_{c}$  verification, but pass either the  $\epsilon_{aC}$  or  $\epsilon_{aCrate}$  verification, use the value from indirect fuel measurement.

(iii) If you fail all three verifications, you must either void the test interval or use the highest value from direct and indirect fuel measurements. Note that we will consider our test results to be invalid if we fail all three verifications.

**§ 1036.540 Determining cycle-average engine fuel maps.**

(a) *Overview.* This section describes how to determine an engine's cycle-average fuel maps for model year 2021 and later vehicles. Vehicle manufacturers may need cycle-average fuel maps for transient duty cycles, highway cruise cycles, or both to demonstrate compliance with emission standards under 40 CFR part 1037. Generate cycle-average engine fuel maps as follows:

(1) Determine the engine's torque maps as described in § 1036.505(c).

(2) Determine the engine's steady-state fuel map and fuel consumption at idle as described in § 1036.535. If you are applying cycle-average fuel mapping for highway cruise cycles, you may instead use GEM's default fuel map instead of generating the steady-state fuel map in § 1036.535(b).

(3) Simulate several different vehicle configurations using GEM (see 40 CFR 1037.520) to create new engine duty cycles as described in paragraph (c) of this section. The transient vehicle duty cycles for this simulation are in 40 CFR part 1037, appendix A; the highway cruise cycles with grade are in 40 CFR part 1037, appendix D. Note that GEM simulation relies on vehicle service classes as described in 40 CFR 1037.140.

(4) Test the engines using the new duty cycles to determine fuel consumption, cycle work, and average vehicle speed as described in paragraph (d) of this section and establish GEM inputs for those parameters for further vehicle simulations as described in paragraph (e) of this section.

(b) *General test provisions.* The following provisions apply for testing under this section:

(1) To perform fuel mapping under this section for hybrid engines, make sure the engine and its hybrid features are appropriately configured to represent the hybrid features in your testing.

(2) Measure NO<sub>x</sub> emissions for each specified sampling period in grams. You may perform these measurements using a NO<sub>x</sub> emission-measurement system that meets the requirements of 40 CFR part 1065, subpart J. Include these measured NO<sub>x</sub> values any time you report to us your fuel-consumption

values from testing under this section. If a system malfunction prevents you from measuring NO<sub>x</sub> emissions during a test under this section but the test otherwise gives valid results, you may consider this a valid test and omit the NO<sub>x</sub> emission measurements; however, we may require you to repeat the test if we determine that you inappropriately voided the test with respect to NO<sub>x</sub> emission measurement.

(3) The provisions related to carbon balance error verification in § 1036.543 apply for all testing in this section. These procedures are optional, but we will perform carbon balance error verification for all testing under this section.

(4) Correct fuel mass to a mass-specific net energy content of a reference fuel as described in paragraph (d)(13) of this section.

(5) This section uses engine parameters and variables that are consistent with 40 CFR part 1065.

(c) *Create engine duty cycles.* Use GEM to simulate your engine operation with several different vehicle configurations to create transient and highway cruise engine duty cycles corresponding to each vehicle configuration as follows:

(1) Set up GEM to simulate your engine's operation based on your engine's torque maps, steady-state fuel maps, warm-idle speed as defined in 40 CFR 1037.520(h)(1), and fuel consumption at idle as described in paragraphs (a)(1) and (2) of this section.

(2) Set up GEM with transmission parameters for different vehicle service classes and vehicle duty cycles. Specify the transmission's torque limit for each gear as the engine's maximum torque as determined in 40 CFR 1065.510. Specify the transmission type as Automatic Transmission for all engines and for all engine and vehicle duty cycles, except that the transmission type is Automated Manual Transmission for Heavy HDE operating over the highway cruise cycles or the SET duty cycle. For automatic transmissions set neutral idle to "Y" in the vehicle file. Select gear ratios for each gear as shown in the following table:

TABLE 1 TO PARAGRAPH (c)(2) OF § 1036.540—GEM INPUT FOR GEAR RATIO

Gear number	Spark-ignition HDE, light HDE, and medium HDE—all engine and vehicle duty cycles	Heavy HDE—transient and FTP duty cycles	Heavy HDE—cruise and SET duty cycles
1	3.10	3.51	12.8
2	1.81	1.91	9.25

TABLE 1 TO PARAGRAPH (c)(2) OF § 1036.540—GEM INPUT FOR GEAR RATIO—Continued

Gear number	Spark-ignition HDE, light HDE, and medium HDE— all engine and vehicle duty cycles	Heavy HDE— transient and FTP duty cycles	Heavy HDE— cruise and SET duty cycles
3	1.41	1.43	6.76
4	1.00	1.00	4.90
5	0.71	0.74	3.58
6	0.61	0.64	2.61
7			1.89
8			1.38
9			1.00
10			0.73
Lockup Gear	3	3	

(3) Run GEM for each simulated vehicle configuration and use the GEM outputs of instantaneous engine speed and engine flywheel torque for each vehicle configuration to generate a 10 Hz transient duty cycle corresponding to each vehicle configuration operating over each vehicle duty cycle. Run GEM for the specified number of vehicle configurations. You may run additional vehicle configurations to represent a

wider range of in-use vehicles. Run GEM as follows:

(i) *Determining axle ratio and tire size.* Set the axle ratio,  $k_a$ , and tire size,

$$\frac{f_{ntire}}{v_{vehicle}}$$

for each vehicle configuration based on the corresponding designated engine speed ( $f_{nrefA}$ ,  $f_{nrefB}$ ,  $f_{nrefC}$ ,  $f_{nrefD}$ , or  $f_{ntest}$  as defined in 40 CFR 1065.610(c)(2)) at 65 mi/hr for the transient duty cycle and

for the 65 mi/hr highway cruise cycle. Similarly, set these parameters based on the corresponding designated engine speed at 55 mi/hr for the 55 mi/hr highway cruise cycle. Use one of the following equations to determine

$$\frac{f_{ntire}}{v_{vehicle}}$$

and  $k_a$  at each of the defined engine speeds:

(A) Select a value for  $\left[\frac{f_{ntire}}{v_{vehicle}}\right]_{[speed]}$  and solve for  $k_{a[speed]}$  using the following

equation:

$$k_{a[speed]} = \frac{f_{n[speed]}}{\left[\frac{f_{ntire}}{v_{vehicle}}\right]_{[speed]} \cdot k_{topgear} \cdot v_{ref}}$$

Eq. 1036.540-1

Where:

$f_{n[speed]}$  = engine's angular speed as determined in paragraph (c)(3)(ii) or (iii) of this section.

$k_{topgear}$  = transmission gear ratio in the highest available gear from Table 1 of this section.

$v_{ref}$  = reference speed. Use 65 mi/hr for the transient cycle and the 65 mi/hr highway cruise cycle and use 55 mi/hr for the 55 mi/hr highway cruise cycle.

(B) Select a value for  $k_{a[speed]}$  and solve for  $\left[\frac{f_{ntire}}{v_{vehicle}}\right]_{[speed]}$  using the following equation:

$$\left[\frac{f_{ntire}}{v_{vehicle}}\right]_{[speed]} = \frac{f_{n[speed]}}{k_{a[speed]} \cdot k_{topgear} \cdot v_{ref}}$$

Eq. 1036.540-2

*Example for a vocational Light HDV or vocational Medium HDV with a 6-speed automatic transmission at B speed (Test 3 or 4 in Table 3 of this section):*

$k_{aB} = 4.0$   
 $k_{topgear} = 0.61$   
 $v_{ref} = 65 \text{ mi/hr} = 29.06 \text{ m/s}$

$f_{nrefB} = 1870 \text{ r/min} = 31.17 \text{ r/s}$

$$\left[ \frac{f_{ntire}}{v_{vehicle}} \right]_B = \frac{31.17}{4.0 \cdot 0.61 \cdot 29.06}$$

$$\left[ \frac{f_{ntire}}{v_{vehicle}} \right]_B = 0.4396 \text{ r/m}$$

(ii) *Vehicle configurations for Spark-ignition HDE, Light HDE, and Medium HDE.* Test at least eight different vehicle

configurations for engines that will be installed in vocational Light HDV or

vocational Medium HDV using vehicles in the following table:

Table 2 to Paragraph (c)(3)(ii) of § 1036.540—Vehicle Configurations for Testing Spark-ignition HDE, Light HDE, and Medium HDE

Parameter	1	2	3	4	5	6	7	8
$C_{rr}$ (N/kN)	6.2	7.7	6.2	7.7	6.2	7.7	6.2	7.7
CI engine speed for $\frac{f_{ntire}}{v_{vehicle}}$ and $k_a$	$f_{nrefA}$	$f_{nrefA}$	$f_{nrefB}$	$f_{nrefB}$	$f_{nrefC}$	$f_{nrefC}$	$f_{ntest}$	$f_{ntest}$
SI engine speed for $\frac{f_{ntire}}{v_{vehicle}}$ and $k_a$	$f_{nrefD}$	$f_{nrefD}$	$f_{nrefA}$	$f_{nrefA}$	$f_{nrefB}$	$f_{nrefB}$	$f_{nrefC}$	$f_{nrefC}$
Drive Axle Configuration	4x2	4x2	4x2	4x2	4x2	4x2	4x2	4x2
GEM Regulatory Subcategory	LHD	MHD	LHD	MHD	LHD	MHD	LHD	MHD

(iii) *Vehicle configurations for Heavy HDE.* Test at least nine different vehicle configurations for engines that will be installed in vocational Heavy HDV and for tractors that are not heavy-haul tractors. Test six different vehicle configurations for engines that will be installed in heavy-haul tractors. Use the

settings specific to each vehicle configuration as shown in Table 3 or Table 4 in this section, as appropriate. Engines subject to testing under both Table 3 and Table 4 in this section need not repeat overlapping vehicle configurations, so complete fuel mapping requires testing 12 (not 15)

vehicle configurations for those engines. However, the preceding sentence does not apply if you choose to create two separate maps from the vehicle configurations defined in Table 3 and Table 4 in this section. Tables 3 and 4 follow:



Table 3 to Paragraph (c)(3)(iii) of § 1036.540—Vehicle Configurations for Testing Heavy HDE Installed in General Purpose Tractors and Vocational Heavy HDV

Parameter	1	2	3	4	5	6	7	8	9
$C_{rr}$ (N/kN)	6.9	6.9	6.9	6.9	6.9	6.9	6.9	6.9	6.9
$C_dA$	5.4	4.7	4.0	5.4	4.7	4.0	5.4	4.7	4.0
Engine speed for $\frac{f_{ntire}}{v_{vehicle}}$ and $k_a$	$f_{nrefD}$	$f_{nrefD}$	$f_{nrefD}$	$f_{nrefB}$	$f_{nrefB}$	$f_{nrefB}$	$f_{nrtest}$	$f_{nrtest}$	$f_{nrtest}$
Drive Axle Configuration	6x4	6x4	4x2	6x4	6x4	4x2	6x4	6x4	4x2
GEM Regulatory Subcategory	C8_SC_HR	C8_DC_MR	C7_DC_MR	C8_SC_HR	C8_DC_MR	C7_DC_MR	C8_SC_HR	C8_DC_MR	C7_DC_MR
Vehicle Weight Reduction (lbs)	0	13,275	6,147	0	13,275	6,147	0	13,275	6,147

Table 4 to Paragraph (c)(3)(iii) of § 1036.540—Vehicle Configurations for Testing Heavy HDE Installed in Heavy-Haul Tractors

Parameter	1	2	3	4	5	6
$C_{rr}$ (N/kN)	6.9	6.9	6.9	6.9	6.9	6.9
$C_dA$	5.0	5.4	5.0	5.4	5.0	5.4
Engine speed for $\frac{f_{ntire}}{v_{vehicle}}$ and $k_a$	$f_{nrefD}$	$f_{nrefD}$	$f_{nrefB}$	$f_{nrefB}$	$f_{ntest}$	$f_{ntest}$
Drive Axle Configuration	6x4	6x4	6x4	6x4	6x4	6x4
GEM Regulatory Subcategory	C8_HH	C8_SC_HR	C8_HH	C8_SC_HR	C8_HH	C8_SC_HR

(iv) *Vehicle configurations for mixed-use engines.* If the engine will be installed in a combination of vehicles defined in paragraphs (c)(3)(ii) and (iii) of this section, use good engineering judgment to select at least nine vehicle configurations from Table 2 and Table 3 in this section that best represent the range of vehicles your engine will be sold in. This may require you to define additional representative vehicle configurations. For example, if your engines will be installed in vocational Medium HDV and vocational Heavy HDV, you might select Tests 2, 4, 6 and 8 of Table 2 in this section to represent vocational Medium HDV and Tests 3, 6, and 9 of Table 3 in this section to represent vocational Heavy HDV and add two more vehicle configurations that you define.

(v) *Defining GEM inputs.* Use the defined values in Tables 1 through 4 in this section to set up GEM with the correct regulatory subcategory and vehicle weight reduction.

(d) *Test the engine with GEM cycles.* Test the engine over each of the transient engine duty cycles generated in paragraph (c) of this section as follows:

(1) Operate the engine over a sequence of required and optional engine duty cycles as follows:

(i) Sort the list of engine duty cycles into three separate groups by vehicle duty cycle: transient vehicle cycle, 55 mi/hr highway cruise cycle, and 65 mi/hr highway cruise cycle.

(ii) Within each group of engine duty cycles derived from the same vehicle duty cycle, first run the engine duty cycle with the highest reference cycle work, followed by the cycle with the lowest cycle work; followed by the cycle with second-highest cycle work, followed by the cycle with the second-lowest cycle work; continuing through all the cycles for that vehicle duty cycle. The series of engine duty cycles to represent a single vehicle duty cycle is a single fuel-mapping sequence. Each engine duty cycle represents a different interval. Repeat the fuel-mapping sequence for the engine duty cycles derived from the other vehicle duty cycles until testing is complete.

(iii) Operate the engine over two full engine duty cycles to precondition before each interval in the fuel-mapping sequence. Precondition the engine before the first and second engine duty cycle in each fuel-mapping sequence by repeating operation with the engine

duty cycle with the highest reference cycle work over the relevant vehicle duty cycle. The preconditioning for the remaining cycles in the fuel-mapping sequence consists of operation over the preceding two engine duty cycles in the fuel-mapping sequence (with or without measurement). For transient vehicle duty cycles, start each engine duty cycle within 10 seconds after finishing the preceding engine duty cycle (with or without measurement). For highway cruise cycles, start each engine duty cycle and interval after linearly ramping to the speed and torque setpoints over 5 seconds and stabilizing for 15 seconds.

(2) If the engine has an adjustable warm idle speed setpoint, set it to the value defined in 40 CFR 1037.520(h)(1).

(3) Control speed and torque to meet the cycle validation criteria in 40 CFR 1065.514 for each interval, except that the standard error of the estimate in Table 2 of 40 CFR 1065.514 is the only speed criterion that applies if the range of reference speeds is less than 10 percent of the mean reference speed. For spark-ignition gaseous-fueled engines with fuel delivery at a single point in the intake manifold, you may apply the statistical criteria in Table 5 in this section for transient testing. Note that 40

CFR part 1065 does not allow reducing cycle precision to a lower frequency than the 10 Hz reference cycle generated by GEM.

TABLE 5 TO PARAGRAPH (c)(3) OF § 1036.540—STATISTICAL CRITERIA FOR VALIDATING DUTY CYCLES FOR GASEOUS-FUELED SPARK-IGNITION ENGINES <sup>a</sup>

Parameter	Speed	Torque	Power
Slope, $a_1$ .			
Absolute value of intercept, $ a_0 $ .....	.....	≤3% of maximum mapped torque .....	
Standard error of the estimate, $SEE$ .....	.....	≤15% of maximum mapped torque .....	≤15% of maximum mapped power
Coefficient of determination, $r^2$ .....	.....	≥0.700 .....	≥0.750

<sup>a</sup>Statistical criteria apply as specified in 40 CFR 1065.514 unless otherwise specified.

(4) Record measurements using direct and/or indirect measurement of fuel flow as follows:

(i) *Direct fuel-flow measurement.* Record speed and torque and measure fuel consumption with a fuel flow meter for the interval defined by the engine duty cycle. Determine the corresponding mean values for the interval. Use of redundant direct fuel-flow measurements requires our advance approval.

(ii) *Indirect fuel-flow measurement.* Record speed and torque and measure emissions and other inputs needed to run the chemical balance in 40 CFR 1065.655(c) for the interval defined by the engine duty cycle. Determine the corresponding mean values for the interval. Use of redundant indirect fuel-flow measurements requires our advance approval. Measure background concentration as described in 40 CFR 1065.140, except that you may use one of the following methods to apply a single background reading to multiple intervals:

(A) If you use batch sampling to measure background emissions, you may sample periodically into the bag over the course of multiple intervals. If you use this provision, you must apply the same background readings to correct emissions from each of the applicable intervals.

(B) You may determine background emissions by sampling from the dilution air over multiple engine duty cycles. If you use this provision, you must allow sufficient time for stabilization of the background measurement; followed by an averaging period of at least 30 seconds. Use the average of the two background readings to correct the measurement from each engine duty cycle. The first background reading must be taken no greater than 30 minutes before the start of the first applicable engine duty cycle and the second background reading must be taken no later than 30 minutes after the end of the last applicable engine duty cycle. Background readings may not

span more than a full fuel-mapping sequence for a vehicle duty cycle.

(5) Warm up the engine as described in 40 CFR 1065.510(b)(2). Within 60 seconds after concluding the warm-up, start the linear ramp of speed and torque over 20 seconds to the first speed and torque setpoint of the preconditioning cycle.

(6) Precondition the engine before the start of testing as described in paragraph (d)(1)(iii) of this section.

(7) Operate the engine over the first engine duty cycle. Record measurements during the interval. Measure and report NO<sub>x</sub> emissions over each interval as described in paragraph (b)(2) of this section.

(8) Continue testing engine duty cycles that are derived from the other vehicle duty cycles until testing is complete.

(9) You may interrupt the fuel-mapping sequence after completing any interval. You may calibrate analyzers, read and evacuate background bag samples, or sample dilution air for measuring background concentration before restarting. Shut down the engine during any interruption. If you restart the sequence within 30 minutes or less, restart the sequence at paragraph (d)(6) of this section and then restart testing at the next interval in the fuel-mapping sequence. If you restart the sequence after more than 30 minutes, restart the sequence at paragraph (d)(5) of this section and then restart testing at the next interval in the fuel-mapping sequence.

(10) The following provisions apply for infrequent regeneration events, other interruptions during intervals, and otherwise voided intervals:

(i) Stop testing if an infrequent regeneration event occurs during an interval or an interval is interrupted for any other reason. Void the interrupted interval and any additional intervals for which you are not able to meet requirements for measuring background concentration. If the infrequent regeneration event occurs between intervals, void completed intervals only

if you are not able to meet requirements for measuring background concentration for those intervals.

(ii) If an infrequent regeneration event occurs, allow the regeneration event to finish with the engine operating at a speed and load that allows effective regeneration.

(iii) If you interrupt testing during an interval, if you restart the sequence within 30 minutes or less, restart the sequence at paragraph (d)(6) of this section and then restart testing at the next interval in the fuel-mapping sequence. If you restart the sequence after more than 30 minutes, restart the sequence at paragraph (d)(5) of this section and then restart testing at the next interval in the fuel-mapping sequence.

(iv) If you void one or more intervals, you must perform additional testing to get results for all intervals. You may rerun a complete fuel-mapping sequence or any contiguous part of the fuel-mapping sequence. If you get a second valid measurement for any interval, use only the result from the last valid interval. If you restart the sequence within 30 minutes or less, restart the sequence at paragraph (d)(6) of this section and then restart testing at the first selected interval in the fuel-mapping sequence. If you restart the sequence after more than 30 minutes, restart the sequence at paragraph (d)(5) of this section and then restart testing at the first selected interval in the fuel-mapping sequence. Continue testing until you have valid results for all intervals. The following examples illustrate possible scenarios for a partial run through a fuel-mapping sequence:

(A) If you voided only the interval associated with the fourth engine duty cycle in the sequence, you may restart the sequence using the second and third engine duty cycles as the preconditioning cycles and stop after completing the interval associated with the fourth engine duty cycle.

(B) If you voided the intervals associated with the fourth and sixth engine duty cycles, you may restart the

sequence using the second and third engine duty cycles for preconditioning and stop after completing the interval associated with the sixth engine duty cycle.

(11) You may send signals to the engine controller during the test, such

as current transmission gear and vehicle speed, if that allows engine operation to better represent in-use operation.

(12) Calculate the fuel mass,  $m_{fuel}$ , for each duty cycle using one of the following equations:

(i) Determine fuel-consumption using emission measurements from the raw or

diluted exhaust. Calculate the mass of fuel for each duty cycle,  $m_{fuel[cycle]}$ , as follows:

(A) For calculations that use continuous measurement of emissions and continuous CO<sub>2</sub> from urea, calculate  $m_{fuel[cycle]}$  using the following equation:

$$m_{fuel[cycle]} = \frac{M_C}{w_{Cmeas}} \cdot \left( \sum_{i=1}^N \left( \dot{n}_{exhi} \cdot \frac{x_{Ccombdryi}}{1 + x_{H2Oexhdryi}} \cdot \Delta t \right) - \frac{1}{M_{CO2}} \sum_{i=1}^N (\dot{m}_{CO2DEFi} \cdot \Delta t) \right)$$

Eq. 1036.540-3

Where:

$M_C$  = molar mass of carbon.

$w_{Cmeas}$  = carbon mass fraction of fuel (or mixture of fuels) as determined in 40 CFR 1065.655(d), except that you may not use the default properties in Table 2 of 40 CFR 1065.655 to determine  $\alpha$ ,  $\beta$ , and  $w_C$ . You may not account for the contribution to  $\alpha$ ,  $\beta$ ,  $\gamma$ , and  $\delta$  of diesel exhaust fluid or other non-fuel fluids injected into the exhaust.

$i$  = an indexing variable that represents one recorded emission value.

$N$  = total number of measurements over the duty cycle.

$\dot{n}_{exh}$  = exhaust molar flow rate from which you measured emissions.

$x_{Ccombdry}$  = amount of carbon from fuel and any injected fluids in the exhaust per mole of dry exhaust as determined in 40 CFR 1065.655(c).

$x_{H2Oexhdry}$  = amount of H<sub>2</sub>O in exhaust per mole of exhaust as determined in 40 CFR 1065.655(c).

$\Delta t = 1/f_{record}$

$M_{CO2}$  = molar mass of carbon dioxide.

$\dot{m}_{CO2DEFi}$  = mass emission rate of CO<sub>2</sub> resulting from diesel exhaust fluid decomposition over the duty cycle as determined from § 1036.535(b)(9). If your engine does not utilize diesel exhaust fluid for emission control, or if you choose not to perform this correction, set  $\dot{m}_{CO2DEFi}$  equal to 0.

Example:

$M_C = 12.0107$  g/mol

$w_{Cmeas} = 0.867$

$N = 6680$

$\dot{n}_{exh1} = 2.876$  mol/s

$\dot{n}_{exh1} = 2.224$  mol/s

$x_{Ccombdry1} = 2.61 \cdot 10^{-3}$  mol/mol

$x_{Ccombdry2} = 1.91 \cdot 10^{-3}$  mol/mol

$x_{H2Oexh1} = 3.53 \cdot 10^{-2}$  mol/mol

$x_{H2Oexh2} = 3.13 \cdot 10^{-2}$  mol/mol

$f_{record} = 10$  Hz

$\Delta t = 1/10 = 0.1$  s

$M_{CO2} = 44.0095$  g/mol

$\dot{m}_{CO2DEF1} = 0.0726$  g/s

$\dot{m}_{CO2DEF2} = 0.0751$  g/s

$$m_{fueltransientTest1} = \frac{12.0107}{0.867} \cdot \left( \left( \begin{aligned} & \left( \begin{aligned} & 2.876 \cdot \frac{2.61 \cdot 10^{-3}}{1 + 3.53 \cdot 10^{-2}} \cdot 0.1 + \\ & \frac{1.91 \cdot 10^{-3}}{1 + 3.13 \cdot 10^{-2}} \cdot 0.1 + \\ & \dots + \dot{n}_{exh6680} \cdot \frac{x_{Ccombdry6680}}{1 + x_{H2Oexhdry6680}} \cdot \Delta t_{6680} \end{aligned} \right) \\ & - \frac{1}{44.0095} \cdot (0.0726 \cdot 1.0 + 0.0751 \cdot 1.0 + \dots + \dot{m}_{CO2DEF6680} \cdot \Delta t_{6680}) \end{aligned} \right) \right)$$

$m_{fueltransientTest1} = 1619.6$  g

(B) If you measure batch emissions and continuous CO<sub>2</sub> from urea, calculate  $m_{fuel[cycle]}$  using the following equation:

$$m_{fuel[cycle]} = \frac{M_C}{w_{Cmeas}} \cdot \left( \frac{\bar{x}_{Ccombdry}}{1 + \bar{x}_{H2Oexhdry}} \cdot \sum_{i=1}^N (\dot{n}_{exhi} \cdot \Delta t) - \frac{1}{M_{CO2}} \sum_{i=1}^N (\dot{m}_{CO2DEFi} \cdot \Delta t) \right)$$

Eq. 1036.540-4

(C) If you measure continuous emissions and batch CO<sub>2</sub> from urea,

calculate  $m_{fuel[cycle]}$  using the following equation:

$$m_{fuel[cycle]} = \frac{M_C}{w_{Cmeas}} \cdot \left( \sum_{i=1}^N \left( \dot{n}_{exhi} \cdot \frac{x_{Ccombdryi}}{1 + x_{H2Oexhdryi}} \cdot \Delta t \right) - \frac{m_{CO2DEF}}{M_{CO2}} \right)$$

Eq. 1036.540-5

(D) If you measure batch emissions and batch CO<sub>2</sub> from urea, calculate  $m_{\text{fuel}[\text{cycle}]}$  using the following equation:

$$m_{\text{fuel}[\text{cycle}]} = \frac{M_C}{W_{C\text{meas}}} \cdot \left( \frac{\bar{x}_{C\text{combdry}}}{1 + \bar{x}_{\text{H}_2\text{Oexhdry}}} \cdot \sum_{i=1}^N (\dot{n}_{\text{exhi}} \cdot \Delta t) - \frac{m_{\text{CO}_2\text{DEF}}}{M_{\text{CO}_2}} \right)$$

Eq. 1036.540-6

(ii) Manufacturers may choose to measure fuel mass flow rate. Calculate

the mass of fuel for each duty cycle,  $m_{\text{fuel}[\text{cycle}]}$ , as follows:

$$m_{\text{fuel}} = \sum_{i=1}^N \dot{m}_{\text{fuel}i} \cdot \Delta t$$

Eq. 1036.540-7

Where:

- $i$  = an indexing variable that represents one recorded value.
- $N$  = total number of measurements over the duty cycle. For batch fuel mass measurements, set  $N = 1$ .
- $\dot{m}_{\text{fuel}i}$  = the fuel mass flow rate, for each point,  $i$ , starting from  $i = 1$ .
- $\Delta t = 1/f_{\text{record}}$
- $f_{\text{record}}$  = the data recording frequency.

Example:

- $N = 6680$
- $\dot{m}_{\text{fuel}1} = 1.856 \text{ g/s}$
- $\dot{m}_{\text{fuel}2} = 1.962 \text{ g/s}$
- $f_{\text{record}} = 10 \text{ Hz}$
- $\Delta t = 1/10 = 0.1 \text{ s}$
- $m_{\text{fueltransient}} = (1.856 + 1.962 + \dots + \dot{m}_{\text{fuel}6680}) \cdot 0.1$
- $m_{\text{fueltransient}} = 111.95 \text{ g}$

(13) Correct the measured or calculated fuel mass,  $m_{\text{fuel}}$ , for each result to a mass-specific net energy content of a reference fuel as described in § 1036.535(e), replacing  $\bar{m}_{\text{fuel}}$  with  $m_{\text{fuel}}$  in Eq. 1036.535-4.

(e) Determine GEM inputs. Use the results of engine testing in paragraph (d) of this section to determine the GEM

inputs for the transient duty cycle and optionally for each of the highway cruise cycles corresponding to each simulated vehicle configuration as follows:

- (1) Using the calculated fuel mass consumption values,  $m_{\text{fuel}[\text{cycle}]}$ , described in paragraph (d) of this section, declare values using the methods described in § 1036.535(g)(2) and (3).
- (2) We will determine  $m_{\text{fuel}[\text{cycle}]}$  values using the method described in § 1036.535(g)(3).
- (3) For the transient cycle, calculate engine output speed per unit vehicle speed,

$$\left[ \frac{\bar{f}_{\text{engine}}}{\bar{v}_{\text{vehicle}}} \right]_{[\text{cycle}]}$$

by taking the average engine speed measured during the engine test while the vehicle is moving and dividing it by the average vehicle speed provided by GEM. Note that the engine cycle created by GEM has a flag to indicate when the vehicle is moving.

(4) Determine engine idle speed and torque, by taking the average engine speed and torque measured during the engine test while the vehicle is not moving. Note that the engine cycle created by GEM has a flag to indicate when the vehicle is moving.

(5) For the cruise cycles, calculate the average engine output speed,  $\bar{f}_{\text{engine}}$ , and the average engine output torque (positive torque only),  $\bar{T}_{\text{engine}}$ , while the vehicle is moving. Note that the engine cycle created by GEM has a flag to indicate when the vehicle is moving.

(6) Determine positive work according to 40 CFR part 1065,  $W_{[\text{cycle}]}$ , by using the engine speed and engine torque measured during the engine test while the vehicle is moving. Note that the engine cycle created by GEM has a flag to indicate when the vehicle is moving.

(7) The following tables illustrate the GEM data inputs corresponding to the different vehicle configurations for a given duty cycle:

(i) For the transient cycle:

Table 6 to Paragraph (e)(7)(i) of § 1036.540—Generic example of an output matrix for transient cycle vehicle configurations

Parameter	Configuration					
	1	2	3	4	...	<i>n</i>
$m_{\text{fuel}[\text{cycle}]}$						
$\left[ \frac{\bar{f}_{\text{engine}}}{\bar{v}_{\text{vehicle}}} \right]_{[\text{cycle}]}$						
$W_{[\text{cycle}]}$						
$\bar{f}_{\text{idle}}$						
$\bar{T}_{\text{idle}}$						

(ii) For the cruise cycles:

TABLE 7 TO PARAGRAPH (e)(7)(ii) OF § 1036.540—GENERIC EXAMPLE OF AN OUTPUT MATRIX FOR CRUISE CYCLE VEHICLE CONFIGURATIONS

Parameter	Configuration					
	1	2	3	4	...	n
$m_{fuel[cycle]}$ .						
$\bar{i}_{engine[cycle]}$ .						
$\bar{T}_{engine[cycle]}$ .						
$W_{[cycle]}$ .						

**§ 1036.543 Carbon balance error verification.**

The optional carbon balance error verification in 40 CFR 1065.543 compares independent assessments of the flow of carbon through the system (engine plus aftertreatment). This procedure applies for each individual interval in §§ 1036.535(b), (c), and (d) and 1036.540 and 40 CFR 1037.550.

**§ 1036.550 Calculating greenhouse gas emission rates.**

This section describes how to calculate official emission results for CO<sub>2</sub>, CH<sub>4</sub>, and N<sub>2</sub>O.

(a) Calculate brake-specific emission rates for each applicable duty cycle as specified in 40 CFR 1065.650. Apply infrequent regeneration adjustment factors as described in § 1036.580.

(b) Adjust CO<sub>2</sub> emission rates calculated under paragraph (a) of this section for measured test fuel properties as specified in this paragraph (b). This adjustment is intended to make official emission results independent of differences in test fuels within a fuel type. Use good engineering judgment to develop and apply testing protocols to minimize the impact of variations in test fuels.

(1) Determine your test fuel's mass-specific net energy content,  $E_{mfuelmeas}$ , also known as lower heating value, in MJ/kg, expressed to at least three decimal places. Determine  $E_{mfuelmeas}$  as follows:

(i) For liquid fuels, determine  $E_{mfuelmeas}$  according to ASTM D4809 (incorporated by reference in § 1036.810). Have the sample analyzed by at least three different labs and determine the final value of your test fuel's  $E_{mfuelmeas}$  as the median all the lab

test results you obtained. If you have results from three different labs, we recommend you screen them to determine if additional observations are needed. To perform this screening, determine the absolute value of the difference between each lab result and the average of the other two lab results. If the largest of these three resulting absolute value differences is greater than 0.297 MJ/kg, we recommend you obtain additional results prior to determining the final value of  $E_{mfuelmeas}$ .

(ii) For gaseous fuels, determine  $E_{mfuelmeas}$  according to ASTM D3588 (incorporated by reference in § 1036.810).

(2) Determine your test fuel's carbon mass fraction,  $w_C$ , as described in 40 CFR 1065.655(d), expressed to at least three decimal places; however, you must measure fuel properties rather than using the default values specified in Table 1 of 40 CFR 1065.655.

(i) For liquid fuels, have the sample analyzed by at least three different labs and determine the final value of your test fuel's  $w_C$  as the median of all of the lab results you obtained. If you have results from three different labs, we recommend you screen them to determine if additional observations are needed. To perform this screening, determine the absolute value of the difference between each lab result and the average of the other two lab results. If the largest of these three resulting absolute value differences is greater than 1.56 percent carbon, we recommend you obtain additional results prior to determining the final value of  $w_C$ .

(ii) For gaseous fuels, have the sample analyzed by a single lab and use that result as your test fuel's  $w_C$ .

(3) If, over a period of time, you receive multiple fuel deliveries from a single stock batch of test fuel, you may use constant values for mass-specific energy content and carbon mass fraction, consistent with good engineering judgment. To use these constant values, you must demonstrate that every subsequent delivery comes from the same stock batch and that the fuel has not been contaminated.

(4) Correct measured CO<sub>2</sub> emission rates as follows:

$$e_{CO2cor} = e_{CO2} \cdot \frac{E_{mfuelmeas}}{E_{mfuelCref} \cdot w_{Cmeas}}$$

Eq. 1036.550-1

Where:

$e_{CO2}$  = the calculated CO<sub>2</sub> emission result.  
 $E_{mfuelmeas}$  = the mass-specific net energy content of the test fuel as determined in paragraph (b)(1) of this section. Note that dividing this value by  $w_{Cmeas}$  (as is done in this equation) equates to a carbon-specific net energy content having the same units as  $E_{mfuelCref}$ .

$E_{mfuelCref}$  = the reference value of carbon-mass-specific net energy content for the appropriate fuel type, as determined in Table 1 in this section.

$w_{Cmeas}$  = carbon mass fraction of the test fuel (or mixture of test fuels) as determined in paragraph (b)(2) of this section.

Example:

$$\begin{aligned} e_{CO2} &= 630.0 \text{ g/hp-hr} \\ E_{mfuelmeas} &= 42.528 \text{ MJ/kg} \\ E_{mfuelCref} &= 49.3112 \text{ MJ/kgC} \\ w_{Cmeas} &= 0.870 \end{aligned}$$

$$e_{CO2cor} = 630.0 \cdot \frac{42.528}{49.3112 \cdot 0.870}$$

$$e_{CO2cor} = 624.5 \text{ g/hp-hr}$$

TABLE 1 TO PARAGRAPH (b)(4) OF § 1036.550—REFERENCE FUEL PROPERTIES

Fuel type <sup>a</sup>	Reference fuel carbon-mass-specific net energy content, $E_{mfuelCref}$ (MJ/kgC) <sup>b</sup>	Reference fuel carbon mass fraction, $w_{Cref}$ <sup>b</sup>
Diesel fuel .....	49.3112	0.874
Gasoline .....	50.4742	0.846
Natural gas .....	66.2910	0.750
LPG .....	56.5218	0.820
Dimethyl ether .....	55.3886	0.521
High-level ethanol-gasoline blends .....	50.3211	0.576

<sup>a</sup>For fuels that are not listed, you must ask us to approve reference fuel properties.

<sup>b</sup>For multi-fuel streams, such as natural gas with diesel fuel pilot injection, use good engineering judgment to determine blended values for  $E_{mfuelCref}$  and  $w_{Cref}$  using the values in this table.

(c) Your official emission result for each pollutant equals your calculated brake-specific emission rate multiplied by all applicable adjustment factors, other than the deterioration factor.

**§ 1036.555 Test procedures to verify deterioration factors.**

Sections 1036.240 through 1036.246 describe certification procedures to determine, verify, and apply deterioration factors. This section describes the measurement procedures for verifying deterioration factors using PEMS with in-use vehicles.

(a) Use PEMS to collect 1 Hz data throughout a shift-day of driving. Collect all the data elements needed to determine brake-specific emissions. Calculate emission results using moving average windows as described in § 1036.530.

(b) Collect data as needed to perform the calculations specified in paragraph (a) of this section and to submit the test report specified in § 1036.246(d).

**§ 1036.580 Infrequently regenerating aftertreatment devices.**

For engines using aftertreatment technology with infrequent regeneration events that may occur during testing, take one of the following approaches to account for the emission impact of regeneration on criteria pollutant and greenhouse gas emissions:

(a) You may use the calculation methodology described in 40 CFR 1065.680 to adjust measured emission results. Do this by developing an upward adjustment factor and a downward adjustment factor for each pollutant based on measured emission data and observed regeneration frequency as follows:

(1) Adjustment factors should generally apply to an entire engine family, but you may develop separate adjustment factors for different configurations within an engine family. Use the adjustment factors from this

section for all testing for the engine family.

(2) You may use carryover data to establish adjustment factors for an engine family as described in § 1036.235(d), consistent with good engineering judgment.

(3) Identify the value of  $F_{[cycle]}$  in each application for the certification for which it applies.

(4) Calculate separate adjustment factors for each required duty cycle.

(b) You may ask us to approve an alternate methodology to account for regeneration events. We will generally limit approval to cases where your engines use aftertreatment technology with extremely infrequent regeneration and you are unable to apply the provisions of this section.

(c) You may choose to make no adjustments to measured emission results if you determine that regeneration does not significantly affect emission levels for an engine family (or configuration) or if it is not practical to identify when regeneration occurs. You may omit adjustment factors under this paragraph (c) for  $N_2O$ ,  $CH_4$ , or other individual pollutants under this paragraph (c) as appropriate. If you choose not to make adjustments under paragraph (a) or (b) of this section, your engines must meet emission standards for all testing, without regard to regeneration.

**Subpart G—Special Compliance Provisions**

**§ 1036.601 Overview of compliance provisions.**

(a) Engine and vehicle manufacturers, as well as owners, operators, and rebuilders of engines subject to the requirements of this part, and all other persons, must observe the provisions of this part, the provisions of 40 CFR part 1068, and the provisions of the Clean Air Act. The provisions of 40 CFR part 1068 apply for heavy-duty highway

engines as specified in that part, subject to the following provisions:

(1) The exemption provisions of 40 CFR 1068.201 through 1068.230, 1068.240, and 1068.260 through 265 apply for heavy-duty motor vehicle engines. The other exemption provisions, which are specific to nonroad engines, do not apply for heavy-duty vehicles or heavy-duty engines.

(2) Engine signals to indicate a need for maintenance under § 1036.125(a)(1)(ii) are considered an element of design of the emission control system. Disabling, resetting, or otherwise rendering such signals inoperative without also performing the indicated maintenance procedure is therefore prohibited under 40 CFR 1068.101(b)(1).

(3) The warranty-related prohibitions in section 203(a)(4) of the Act (42 U.S.C. 7522(a)(4)) apply to manufacturers of new heavy-duty highway engines in addition to the prohibitions described in 40 CFR 1068.101(b)(6). We may assess a civil penalty up to \$44,539 for each engine or vehicle in violation.

(b) The following provisions from 40 CFR parts 85 and 86 continue to apply after December 20, 2026 for engines subject to the requirements of this part:

(1) The tampering prohibition in 40 CFR 1068.101(b)(1) applies for alternative fuel conversions as specified in 40 CFR part 85, subpart F.

(2) Engine manufacturers must meet service information requirements as specified in 40 CFR 86.010–38(j).

(3) Provisions related to nonconformance penalties apply as described in 40 CFR part 86, subpart L. Note that nonconformance penalty provisions are not available for current or future emission standards unless we revise the regulation to specify how to apply those provisions.

(4) The manufacturer-run in-use testing program described in 40 CFR part 86, subpart T, continues to apply

for engines subject to exhaust emission standards under 40 CFR part 86.

(c) The emergency vehicle field modification provisions of 40 CFR 85.1716 apply with respect to the standards of this part.

(d) Subpart C of this part describes how to test and certify dual-fuel and flexible-fuel engines. Some multi-fuel engines may not fit either of those defined terms. For such engines, we will determine whether it is most appropriate to treat them as single-fuel engines, dual-fuel engines, or flexible-fuel engines based on the range of possible and expected fuel mixtures. For example, an engine might burn natural gas but initiate combustion with a pilot injection of diesel fuel. If the engine is designed to operate with a single fueling algorithm (*i.e.*, fueling rates are fixed at a given engine speed and load condition), we would generally treat it as a single-fuel engine. In this context, the combination of diesel fuel and natural gas would be its own fuel type. If the engine is designed to also operate on diesel fuel alone, we would generally treat it as a dual-fuel engine. If the engine is designed to operate on varying mixtures of the two fuels, we would generally treat it as a flexible-fuel engine. To the extent that requirements vary for the different fuels or fuel mixtures, we may apply the more stringent requirements.

**§ 1036.605 Alternate emission standards for engines used in specialty vehicles.**

Starting in model year 2027, compression-ignition engines at or above 56 kW and spark-ignition engines of any size that will be installed in specialty vehicles as allowed by 40 CFR 1037.605 are exempt from the standards of subpart B of this part if they are certified under this part to alternate emission standards as follows:

(a) Spark-ignition engines must be of a configuration that is identical to one that is certified under 40 CFR part 1048 to Blue Sky standards under 40 CFR 1048.140.

(b) Compression-ignition engines must be of a configuration that is identical to one that is certified under 40 CFR part 1039, and meet the following additional standards using the same duty cycles that apply under 40 CFR part 1039:

(1) The engines must be certified with a family emission limit for PM of 0.020 g/kW-hr.

(2) Diesel-fueled engines using selective catalytic reduction must meet an emission standard of 0.1 g/kW-hr for N<sub>2</sub>O.

(c) Except as specified in this section, engines certified under this section

must meet all the requirements that apply under 40 CFR part 1039 or 1048 instead of the comparable provisions in this part. Before shipping engines under this section, you must have written assurance from vehicle manufacturers that they need a certain number of exempted engines under this section. In your annual production report under 40 CFR 1039.250 or 1048.250, count these engines separately and identify the vehicle manufacturers that will be installing them. Treat these engines as part of the corresponding engine family under 40 CFR part 1039 or part 1048 for compliance purposes such as testing production engines, in-use testing, defect reporting, and recall.

(d) The engines must be labeled as described in § 1036.135, with the following statement instead of the one specified in § 1036.135(c)(8): “This engine conforms to alternate standards for specialty vehicles under 40 CFR 1036.605.” Engines certified under this section may not have the label specified for nonroad engines in 40 CFR part 1039 or 1048 or any other label identifying them as nonroad engines.

(e) In a separate application for a certificate of conformity, identify the corresponding nonroad engine family, describe the label required under section, state that you meet applicable diagnostic requirements under 40 CFR part 1039 or part 1048, and identify your projected nationwide production volume.

(f) No additional certification fee applies for engines certified under this section.

(g) Engines certified under this section may not generate or use emission credits under this part or under 40 CFR part 1039. The vehicles in which these engines are installed may generate or use emission credits as described in 40 CFR part 1037.

**§ 1036.610 Off-cycle technology credits and adjustments for reducing greenhouse gas emissions.**

(a) You may ask us to apply the provisions of this section for CO<sub>2</sub> emission reductions resulting from powertrain technologies that were not in common use with heavy-duty vehicles before model year 2010 that are not reflected in the specified procedure. While you are not required to prove that such technologies were not in common use with heavy-duty vehicles before model year 2010, we will not approve your request if we determine that they do not qualify. We will apply these provisions only for technologies that will result in a measurable, demonstrable, and verifiable real-world CO<sub>2</sub> reduction. Note that prior to model

year 2016, these technologies were referred to as “innovative technologies”.

(b) The provisions of this section may be applied as either an improvement factor (used to adjust emission results) or as a separate credit, consistent with good engineering judgment. Note that the term “credit” in this section describes an additive adjustment to emission rates and is not equivalent to an emission credit in the ABT program of subpart H of this part. We recommend that you base your credit/adjustment on A to B testing of pairs of engines/vehicles differing only with respect to the technology in question.

(1) Calculate improvement factors as the ratio of in-use emissions with the technology divided by the in-use emissions without the technology. Adjust the emission results by multiplying by the improvement factor. Use the improvement-factor approach where good engineering judgment indicates that the actual benefit will be proportional to emissions measured over the procedures specified in this part. For example, the benefits from technologies that reduce engine operation would generally be proportional to the engine’s emission rate.

(2) Calculate separate credits based on the difference between the in-use emission rate (g/ton-mile) with the technology and the in-use emission rate without the technology. Subtract this value from your measured emission result and use this adjusted value to determine your FEL. We may also allow you to calculate the credits based on g/hp-hr emission rates. Use the separate-credit approach where good engineering judgment indicates that the actual benefit will not be proportional to emissions measured over the procedures specified in this part.

(3) We may require you to discount or otherwise adjust your improvement factor or credit to account for uncertainty or other relevant factors.

(c) Send your request to the Designated Compliance Officer. We recommend that you do not begin collecting data (for submission to EPA) before contacting us. For technologies for which the vehicle manufacturer could also claim credits (such as transmissions in certain circumstances), we may require you to include a letter from the vehicle manufacturer stating that it will not seek credits for the same technology. Your request must contain the following items:

(1) A detailed description of the off-cycle technology and how it functions to reduce CO<sub>2</sub> emissions under conditions not represented on the duty cycles required for certification.

(2) A list of the engine configurations that will be equipped with the technology.

(3) A detailed description and justification of the selected engines.

(4) All testing and simulation data required under this section, plus any other data you have considered in your analysis. You may ask for our preliminary approval of your plan under § 1036.210.

(5) A complete description of the methodology used to estimate the off-cycle benefit of the technology and all supporting data, including engine testing and in-use activity data. Also include a statement regarding your recommendation for applying the provisions of this section for the given technology as an improvement factor or a credit.

(6) An estimate of the off-cycle benefit by engine model, and the fleetwide benefit based on projected sales of engine models equipped with the technology.

(7) A demonstration of the in-use durability of the off-cycle technology, based on any available engineering analysis or durability testing data (either by testing components or whole engines).

(d) We may seek public comment on your request, consistent with the provisions of 40 CFR 86.1869–12(d). However, we will generally not seek public comment on credits/adjustments based on A to B engine dynamometer testing, chassis testing, or in-use testing.

(e) We may approve an improvement factor or credit for any configuration that is properly represented by your testing.

(1) For model years before 2021, you may continue to use an approved improvement factor or credit for any appropriate engine families in future model years through 2020.

(2) For model years 2021 and later, you may not rely on an approval for model years before 2021. You must separately request our approval before applying an improvement factor or credit under this section for 2021 and later engines, even if we approved an improvement factor or credit for similar engine models before model year 2021. Note that approvals for model year 2021 and later may carry over for multiple years.

**§ 1036.615 Engines with Rankine cycle waste heat recovery and hybrid powertrains.**

This section specifies how to generate advanced-technology emission credits for hybrid powertrains that include energy storage systems and regenerative braking (including regenerative engine

braking) and for engines that include Rankine-cycle (or other bottoming cycle) exhaust energy recovery systems. This section applies only for model year 2020 and earlier engines.

(a) *Pre-transmission hybrid powertrains.* Test pre-transmission hybrid powertrains with the hybrid engine procedures of 40 CFR part 1065 or with the post-transmission procedures in 40 CFR 1037.550. Pre-transmission hybrid powertrains are those engine systems that include features to recover and store energy during engine motoring operation but not from the vehicle's wheels. Engines certified with pre-transmission hybrid powertrains must be certified to meet the diagnostic requirements as specified in § 1036.110 with respect to powertrain components and systems; if different manufacturers produce the engine and the hybrid powertrain, the hybrid powertrain manufacturer may separately certify its powertrain relative to diagnostic requirements.

(b) *Rankine engines.* Test engines that include Rankine-cycle exhaust energy recovery systems according to the procedures specified in subpart F of this part unless we approve alternate procedures.

(c) *Calculating credits.* Calculate credits as specified in subpart H of this part. Credits generated from engines and powertrains certified under this section may be used in other averaging sets as described in § 1036.740(c).

(d) *Off-cycle technologies.* You may certify using both the provisions of this section and the off-cycle technology provisions of § 1036.610, provided you do not double-count emission benefits.

**§ 1036.620 Alternate CO<sub>2</sub> standards based on model year 2011 compression-ignition engines.**

For model years 2014 through 2016, you may certify your compression-ignition engines to the CO<sub>2</sub> standards of this section instead of the CO<sub>2</sub> standards in § 1036.108. However, you may not certify engines to these alternate standards if they are part of an averaging set in which you carry a balance of banked credits. You may submit applications for certifications before using up banked credits in the averaging set, but such certificates will not become effective until you have used up (or retired) your banked credits in the averaging set. For purposes of this section, you are deemed to carry credits from advanced technology that are allowed to be used in that averaging set.

(a) The standards of this section are determined from the measured emission rate of the engine of the applicable

baseline 2011 engine family or families as described in paragraphs (b) and (c) of this section. Calculate the CO<sub>2</sub> emission rate of the baseline engine using the same equations used for showing compliance with the otherwise applicable standard. The alternate CO<sub>2</sub> standard for light and medium heavy-duty vocational-certified engines (certified for CO<sub>2</sub> using the transient cycle) is equal to the baseline emission rate multiplied by 0.975. The alternate CO<sub>2</sub> standard for tractor-certified engines (certified for CO<sub>2</sub> using the SET duty cycle) and all other Heavy HDE is equal to the baseline emission rate multiplied by 0.970. The in-use FEL for these engines is equal to the alternate standard multiplied by 1.03.

(b) This paragraph (b) applies if you do not certify all your engine families in the averaging set to the alternate standards of this section. Identify separate baseline engine families for each engine family that you are certifying to the alternate standards of this section. For an engine family to be considered the baseline engine family, it must meet the following criteria:

(1) It must have been certified to all applicable emission standards in model year 2011. If the baseline engine was certified to a NO<sub>x</sub> FEL above the standard and incorporated the same emission control technologies as the new engine family, you may adjust the baseline CO<sub>2</sub> emission rate to be equivalent to an engine meeting the 0.20 g/hp-hr NO<sub>x</sub> standard (or your higher FEL as specified in this paragraph (b)(1)), using certification results from model years 2009 through 2011, consistent with good engineering judgment.

(i) Use the following equation to relate model year 2009–2011 NO<sub>x</sub> and CO<sub>2</sub> emission rates (g/hp-hr):  $CO_2 = a \times \log(NO_x) + b$ .

(ii) For model year 2014–2016 engines certified to NO<sub>x</sub> FELs above 0.20 g/hp-hr, correct the baseline CO<sub>2</sub> emissions to the actual NO<sub>x</sub> FELs of the 2014–2016 engines.

(iii) Calculate separate adjustments for emissions over the SET duty cycle and the transient cycle.

(2) The baseline configuration tested for certification must have the same engine displacement as the engines in the engine family being certified to the alternate standards, and its rated power must be within five percent of the highest rated power in the engine family being certified to the alternate standards.

(3) The model year 2011 U.S.-directed production volume of the configuration tested must be at least one percent of the



total 2011 U.S.-directed production volume for the engine family.

(4) The tested configuration must have cycle-weighted BSFC equivalent to or better than all other configurations in the engine family.

(c) This paragraph (c) applies if you certify all your engine families in the primary intended service class to the alternate standards of this section. For purposes of this section, you may combine Light HDE and Medium HDE into a single averaging set. Determine your baseline CO<sub>2</sub> emission rate as the production-weighted emission rate of the certified engine families you produced in the 2011 model year. If you produce engines for both tractors and vocational vehicles, treat them as separate averaging sets. Adjust the CO<sub>2</sub> emission rates to be equivalent to an engine meeting the average NO<sub>x</sub> FEL of new engines (assuming engines certified to the 0.20 g/hp-hr NO<sub>x</sub> standard have a NO<sub>x</sub> FEL equal to 0.20 g/hp-hr), as described in paragraph (b)(1) of this section.

(d) Include the following statement on the emission control information label: "THIS ENGINE WAS CERTIFIED TO AN ALTERNATE CO<sub>2</sub> STANDARD UNDER 40 CFR 1036.620."

(e) You may not bank CO<sub>2</sub> emission credits for any engine family in the same averaging set and model year in which you certify engines to the standards of this section. You may not bank any advanced-technology credits in any averaging set for the model year you certify under this section (since such credits would be available for use in this averaging set). Note that the provisions of § 1036.745 apply for deficits generated with respect to the standards of this section.

(f) You need our approval before you may certify engines under this section, especially with respect to the numerical value of the alternate standards. We will not approve your request if we determine that you manipulated your engine families or engine configurations to certify to less stringent standards, or that you otherwise have not acted in good faith. You must keep and provide to us any information we need to determine that your engine families meet the requirements of this section. Keep these records for at least five years after you stop producing engines certified under this section.

**§ 1036.625 In-use compliance with CO<sub>2</sub> family emission limits (FELs).**

Section 1036.225 describes how to change the FEL for an engine family during the model year. This section, which describes how you may ask us to increase an engine family's CO<sub>2</sub> FEL

after the end of the model year, is intended to address circumstances in which it is in the public interest to apply a higher in-use CO<sub>2</sub> FEL based on forfeiting an appropriate number of emission credits. For example, this may be appropriate where we determine that recalling vehicles would not significantly reduce in-use emissions. We will generally not allow this option where we determine the credits being forfeited would likely have expired.

(a) You may ask us to increase an engine family's FEL after the end of the model year if you believe some of your in-use engines exceed the CO<sub>2</sub> FEL that applied during the model year (or the CO<sub>2</sub> emission standard if the family did not generate or use emission credits). We may consider any available information in making our decision to approve or deny your request.

(b) If we approve your request under this section, you must apply emission credits to cover the increased FEL for all affected engines. Apply the emission credits as part of your credit demonstration for the current production year. Include the appropriate calculations in your final report under § 1036.730.

(c) Submit your request to the Designated Compliance Officer. Include the following in your request:

(1) Identify the names of each engine family that is the subject of your request. Include separate family names for different model years

(2) Describe why your request does not apply for similar engine models or additional model years, as applicable.

(3) Identify the FEL(s) that applied during the model year and recommend a replacement FEL for in-use engines; include a supporting rationale to describe how you determined the recommended replacement FEL.

(4) Describe whether the needed emission credits will come from averaging, banking, or trading.

(d) If we approve your request, we will identify the replacement FEL. The value we select will reflect our best judgment to accurately reflect the actual in-use performance of your engines, consistent with the testing provisions specified in this part. We may apply the higher FELs to other engine families from the same or different model years to the extent they used equivalent emission controls. We may include any appropriate conditions with our approval.

(e) If we order a recall for an engine family under 40 CFR 1068.505, we will no longer approve a replacement FEL under this section for any of your engines from that engine family, or from

any other engine family that relies on equivalent emission controls.

**§ 1036.630 Certification of engine greenhouse gas emissions for powertrain testing.**

For engines included in powertrain families under 40 CFR part 1037, you may choose to include the corresponding engine emissions in your engine families under this part instead of (or in addition to) the otherwise applicable engine fuel maps.

(a) If you choose to certify powertrain fuel maps in an engine family, the declared powertrain emission levels become standards that apply for selective enforcement audits and in-use testing. We may require that you provide to us the engine cycle (not normalized) corresponding to a given powertrain for each of the specified duty cycles.

(b) If you choose to certify only fuel map emissions for an engine family and to not certify emissions over powertrain cycles under 40 CFR 1037.550, we will not presume you are responsible for emissions over the powertrain cycles. However, where we determine that you are responsible in whole or in part for the emission exceedance in such cases, we may require that you participate in any recall of the affected vehicles. Note that this provision to limit your responsibility does not apply if you also hold the certificate of conformity for the vehicle.

(c) If you split an engine family into subfamilies based on different fuel-mapping procedures as described in § 1036.230(f)(2), the fuel-mapping procedures you identify for certifying each subfamily also apply for selective enforcement audits and in-use testing.

**§ 1036.655 Special provisions for diesel-fueled engines sold in American Samoa or the Commonwealth of the Northern Mariana Islands.**

(a) The prohibitions in § 1068.101(a)(1) do not apply to diesel-fueled engines that are intended for use and will be used in American Samoa or the Commonwealth of the Northern Mariana Islands, subject to the following conditions:

(1) The engine meets the emission standards that applied to model year 2006 engines as specified in appendix A of this part.

(2) You meet all the requirements of 40 CFR 1068.265.

(b) If you introduce an engine into U.S. commerce under this section, you must meet the labeling requirements in § 1036.135, but add the following statement instead of the compliance statement in § 1036.135(c)(8):

THIS ENGINE (or VEHICLE, as applicable) CONFORMS TO US EPA EMISSION STANDARDS APPLICABLE TO MODEL YEAR 2006. THIS ENGINE (or VEHICLE, as applicable) DOES NOT CONFORM TO US EPA EMISSION REQUIREMENTS IN EFFECT AT TIME OF PRODUCTION AND MAY NOT BE IMPORTED INTO THE UNITED STATES OR ANY TERRITORY OF THE UNITED STATES EXCEPT AMERICAN SAMOA OR THE COMMONWEALTH OF THE NORTHERN MARIANA ISLANDS.

(c) Introducing into U.S. commerce an engine exempted under this section in any state or territory of the United States other than American Samoa or the Commonwealth of the Northern Mariana Islands, throughout its lifetime, violates the prohibitions in 40 CFR 1068.101(a)(1), unless it is exempt under a different provision.

(d) The exemption provisions in this section also applied for model year 2007 and later engines introduced into commerce in Guam before January 1, 2024.

#### Subpart H—Averaging, Banking, and Trading for Certification

##### § 1036.701 General provisions.

(a) You may average, bank, and trade (ABT) emission credits for purposes of certification as described in this subpart and in subpart B of this part to show compliance with the standards of §§ 1036.104 and 1036.108. Participation in this program is voluntary. Note that certification to NO<sub>x</sub> standards in § 1036.104 is based on a family emission limit (FEL) and certification to CO<sub>2</sub> standards in § 1036.108 is based on a Family Certification Level (FCL). This part refers to “FEL/FCL” to simultaneously refer to FELs for NO<sub>x</sub> and FCLs for CO<sub>2</sub>. Note also that subpart B of this part requires you to assign an FCL to all engine families, whether or not they participate in the ABT provisions of this subpart.

(b) The definitions of subpart I of this part apply to this subpart in addition to the following definitions:

(1) *Actual emission credits* means emission credits you have generated that we have verified by reviewing your final report.

(2) *Averaging set* means a set of engines in which emission credits may be exchanged. See § 1036.740.

(3) *Broker* means any entity that facilitates a trade of emission credits between a buyer and seller.

(4) *Buyer* means the entity that receives emission credits as a result of a trade.

(5) *Reserved emission credits* means emission credits you have generated that we have not yet verified by reviewing your final report.

(6) *Seller* means the entity that provides emission credits during a trade.

(7) *Standard* means the emission standard that applies under subpart B of this part for engines not participating in the ABT program of this subpart.

(8) *Trade* means to exchange emission credits, either as a buyer or seller.

(c) Emission credits may be exchanged only within an averaging set, except as specified in § 1036.740.

(d) You may not use emission credits generated under this subpart to offset any emissions that exceed an FEL/FCL or standard. This paragraph (d) applies for all testing, including certification testing, in-use testing, selective enforcement audits, and other production-line testing. However, if emissions from an engine exceed an FEL/FCL or standard (for example, during a selective enforcement audit), you may use emission credits to recertify the engine family with a higher FEL/FCL that applies only to future production.

(e) You may use either of the following approaches to retire or forego emission credits:

(1) You may retire emission credits generated from any number of your engines. This may be considered donating emission credits to the environment. Identify any such credits in the reports described in § 1036.730. Engines must comply with the applicable FELs even if you donate or sell the corresponding emission credits. Donated credits may no longer be used by anyone to demonstrate compliance with any EPA emission standards.

(2) You may certify an engine family using an FEL/FCL below the emission standard as described in this part and choose not to generate emission credits for that family. If you do this, you do not need to calculate emission credits for those engine families, and you do not need to submit or keep the associated records described in this subpart for that family.

(f) Emission credits may be used in the model year they are generated. Surplus emission credits may be banked for future model years. Surplus emission credits may sometimes be used for past model years, as described in § 1036.745.

(g) You may increase or decrease an FEL/FCL during the model year by amending your application for certification under § 1036.225. The new FEL/FCL may apply only to engines you

have not already introduced into commerce.

(h) See § 1036.740 for special credit provisions that apply for greenhouse gas credits generated under 40 CFR 86.1819–14(k)(7) or § 1036.615 or 40 CFR 1037.615.

(i) Unless the regulations in this part explicitly allow it, you may not calculate Phase 1 credits more than once for any emission reduction. For example, if you generate Phase 1 CO<sub>2</sub> emission credits for a hybrid engine under this part for a given vehicle, no one may generate CO<sub>2</sub> emission credits for that same hybrid engine and the associated vehicle under 40 CFR part 1037. However, Phase 1 credits could be generated for identical vehicles using engines that did not generate credits under this part.

(j) Credits you generate with compression-ignition engines in 2020 and earlier model years may be used in model year 2021 and later as follows:

(1) For credit-generating engines certified to the tractor engine standards in § 1036.108, you may use credits calculated relative to the tractor engine standards.

(2) For credit-generating engines certified to the vocational engine standards in § 1036.108, you may optionally carry over adjusted vocational credits from an averaging set, and you may use credits calculated relative to the emission levels in the following table:

TABLE 1 TO PARAGRAPH (j)(2) OF § 1036.701—EMISSION LEVELS FOR CREDIT CALCULATION

Medium HDE	Heavy HDE
558 g/hp-hr .....	525 g/hp-hr.

(k) Engine families you certify with a nonconformance penalty under 40 CFR part 86, subpart L, may not generate emission credits.

##### § 1036.705 Generating and calculating emission credits.

(a) The provisions of this section apply separately for calculating emission credits for each pollutant.

(b) For each participating family, calculate positive or negative emission credits relative to the otherwise applicable emission standard. Calculate positive emission credits for a family that has an FEL/FCL below the standard. Calculate negative emission credits for a family that has an FEL/FCL above the standard. Sum your positive and negative credits for the model year before rounding.

(1) Calculate emission credits to the nearest megagram (Mg) for each family

or subfamily using the following equation:

$$\text{Emission credits (Mg)} = (\text{Std} - \text{FL}) \cdot \text{CF} \cdot \text{Volume} \cdot \text{UL} \cdot c \text{ Eq. 1036.705-1}$$

Where:

*Std* = the emission standard, in (mg NO<sub>x</sub>)/hp-hr or (g CO<sub>2</sub>)/hp-hr, that applies under subpart B of this part for engines not participating in the ABT program of this subpart (the "otherwise applicable standard").

*FL* = the engine family's FEL for NO<sub>x</sub>, in mg/hp-hr, and FCL for CO<sub>2</sub>, in g/hp-hr, rounded to the same number of decimal places as the emission standard.

*CF* = a transient cycle conversion factor (hp-hr/mile), calculated by dividing the total (integrated) horsepower-hour over the applicable duty cycle by 6.3 miles for engines subject to spark-ignition standards and 6.5 miles for engines subject to compression-ignition standards. This represents the average work performed over the duty cycle. See paragraph (b)(3) of this section for provisions that apply for CO<sub>2</sub>.

*Volume* = the number of engines eligible to participate in the averaging, banking, and trading program within the given engine family or subfamily during the model year, as described in paragraph (c) of this section.

*UL* = the useful life for the standard that applies for a given primary intended service class, in miles.

*c* = use 10<sup>-6</sup> for CO<sub>2</sub> and 10<sup>-9</sup> for NO<sub>x</sub>.

*Example for Model Year 2025 Heavy HDE Generating CO<sub>2</sub> Credits for a Model Year 2028 Heavy HDE:*

*Std* = 432 g/hp-hr

*FL* = 401 g/hp-hr

*CF* = 9.78 hp-hr/mile

*Volume* = 15,342

*UL* = 435,000 miles

*c* = 10<sup>-6</sup>

*Emission credits* = (432 - 401) · 9.78 · 15,342 · 435,000 · 10<sup>-6</sup>

*Emission credits* = 28,131,142 Mg

(2) [Reserved]

(3) The following additional provisions apply for calculating CO<sub>2</sub> credits:

(i) For engine families certified to both the vocational and tractor engine standards, calculate credits separately for the vocational engines and the tractor engines. We may allow you to use statistical methods to estimate the total production volumes where a small fraction of the engines cannot be tracked precisely.

(ii) Calculate the transient cycle conversion factor for vocational engines based on the average of vocational engine configurations weighted by their production volumes. Similarly, calculate the transient cycle conversion factor for tractor engines based on the

average of tractor engine configurations weighted by their production volumes. Note that calculating the transient cycle conversion factor for tractors requires you to use the conversion factor even for engines certified to standards based on the SET duty cycle.

(iii) The FCL for CO<sub>2</sub> is based on measurement over the FTP duty cycle for vocational engines and over the SET duty cycle for tractor engines.

(4) You may not generate emission credits for tractor engines (*i.e.*, engines not certified to the transient cycle for CO<sub>2</sub>) installed in vocational vehicles (including vocational tractors certified under 40 CFR 1037.630 or exempted under 40 CFR 1037.631). We will waive this provision where you demonstrate that less than five percent of the engines in your tractor family were installed in vocational vehicles. For example, if you know that 96 percent of your tractor engines were installed in non-vocational tractors but cannot determine the vehicle type for the remaining four percent, you may generate credits for all the engines in the family.

(5) You may generate CO<sub>2</sub> emission credits from a model year 2021 or later medium heavy-duty engine family subject to spark-ignition standards for exchanging with other engine families only if the engines in the family are gasoline-fueled. You may generate CO<sub>2</sub> credits from non-gasoline engine families only for the purpose of offsetting CH<sub>4</sub> and/or N<sub>2</sub>O emissions within the same engine family as described in paragraph (d) of this section.

(c) As described in § 1036.730, compliance with the requirements of this subpart is determined at the end of the model year based on actual U.S.-directed production volumes. Keep appropriate records to document these production volumes. Do not include any of the following engines to calculate emission credits:

(1) Engines that you do not certify to the CO<sub>2</sub> standards of this part because they are permanently exempted under subpart G of this part or under 40 CFR part 1068.

(2) Exported engines.

(3) Engines not subject to the requirements of this part, such as those excluded under § 1036.5. For example, do not include engines used in vehicles certified to the greenhouse gas standards of 40 CFR 86.1819.

(4) Any other engines if we indicate elsewhere in this part that they are not to be included in the calculations of this subpart.

(d) You may use CO<sub>2</sub> emission credits to show compliance with CH<sub>4</sub> and/or N<sub>2</sub>O FELs instead of the otherwise applicable emission standards. To do this, calculate the CH<sub>4</sub> and/or N<sub>2</sub>O emission credits needed (negative credits) using the equation in paragraph (b) of this section, using the FEL(s) you specify for your engines during certification instead of the FCL. You must use 34 Mg of positive CO<sub>2</sub> credits to offset 1 Mg of negative CH<sub>4</sub> credits for model year 2021 and later engines, and you must use 25 Mg of positive CO<sub>2</sub> credits to offset 1 Mg of negative CH<sub>4</sub> credits for earlier engines. You must use 298 Mg of positive CO<sub>2</sub> credits to offset 1 Mg of negative N<sub>2</sub>O credits.

#### § 1036.710 Averaging.

(a) Averaging is the exchange of emission credits among your engine families. You may average emission credits only within the same averaging set, except as specified in § 1036.740.

(b) You may certify one or more engine families to an FEL/FCL above the applicable standard, subject to any applicable FEL caps and other the provisions in subpart B of this part, if you show in your application for certification that your projected balance of all emission-credit transactions in that model year is greater than or equal to zero, or that a negative balance is allowed under § 1036.745.

(c) If you certify an engine family to an FEL/FCL that exceeds the otherwise applicable standard, you must obtain enough emission credits to offset the engine family's deficit by the due date for the final report required in § 1036.730. The emission credits used to address the deficit may come from your other engine families that generate emission credits in the same model year (or from later model years as specified in § 1036.745), from emission credits you have banked, or from emission credits you obtain through trading.

#### § 1036.715 Banking.

(a) Banking is the retention of surplus emission credits by the manufacturer generating the emission credits for use in future model years for averaging or trading.

(b) You may designate any emission credits you plan to bank in the reports you submit under § 1036.730 as reserved credits. During the model year and before the due date for the final report, you may designate your reserved emission credits for averaging or trading.

(c) Reserved credits become actual emission credits when you submit your final report. However, we may revoke these emission credits if we are unable to verify them after reviewing your reports or auditing your records.

(d) Banked credits retain the designation of the averaging set in which they were generated.

#### § 1036.720 Trading.

(a) Trading is the exchange of emission credits between manufacturers. You may use traded emission credits for averaging, banking, or further trading transactions. Traded emission credits remain subject to the averaging-set restrictions based on the averaging set in which they were generated.

(b) You may trade actual emission credits as described in this subpart. You may also trade reserved emission credits, but we may revoke these emission credits based on our review of your records or reports or those of the company with which you traded emission credits. You may trade banked credits within an averaging set to any certifying manufacturer.

(c) If a negative emission credit balance results from a transaction, both the buyer and seller are liable, except in cases we deem to involve fraud. See § 1036.255(e) for cases involving fraud. We may void the certificates of all engine families participating in a trade that results in a manufacturer having a negative balance of emission credits. See § 1036.745.

#### § 1036.725 Required information for certification.

(a) You must declare in your application for certification your intent to use the provisions of this subpart for each engine family that will be certified using the ABT program. You must also declare the FEL/FCL you select for the engine family for each pollutant for which you are using the ABT program. Your FELs must comply with the specifications of subpart B of this part, including the FEL caps.

(b) Include the following in your application for certification:

(1) A statement that, to the best of your belief, you will not have a negative balance of emission credits for any averaging set when all emission credits are calculated at the end of the year; or

a statement that you will have a negative balance of emission credits for one or more averaging sets, but that it is allowed under § 1036.745.

(2) Detailed calculations of projected emission credits (positive or negative) based on projected U.S.-directed production volumes. We may require you to include similar calculations from your other engine families to project your net credit balances for the model year. If you project negative emission credits for a family, state the source of positive emission credits you expect to use to offset the negative emission credits.

#### § 1036.730 ABT reports.

(a) If you certify any of your engine families using the ABT provisions of this subpart, you must send us a final report by September 30 following the end of the model year.

(b) Your report must include the following information for each engine family participating in the ABT program:

(1) Engine-family designation and averaging set.

(2) The emission standards that would otherwise apply to the engine family.

(3) The FEL/FCL for each pollutant. If you change the FEL/FCL after the start of production, identify the date that you started using the new FEL/FCL and/or give the engine identification number for the first engine covered by the new FEL/FCL. In this case, identify each applicable FEL/FCL and calculate the positive or negative emission credits as specified in § 1036.225(f).

(4) The projected and actual U.S.-directed production volumes for the model year. If you changed an FEL/FCL during the model year, identify the actual U.S.-directed production volume associated with each FEL/FCL.

(5) The transient cycle conversion factor for each engine configuration as described in § 1036.705.

(6) Useful life.

(7) Calculated positive or negative emission credits for the whole engine family. Identify any emission credits that you traded, as described in paragraph (d)(1) of this section.

(c) Your report must include the following additional information:

(1) Show that your net balance of emission credits from all your participating engine families in each averaging set in the applicable model year is not negative, except as allowed under § 1036.745. Your credit tracking must account for the limitation on credit life under § 1036.740(d).

(2) State whether you will reserve any emission credits for banking.

(3) State that the report's contents are accurate.

(d) If you trade emission credits, you must send us a report within 90 days after the transaction, as follows:

(1) As the seller, you must include the following information in your report:

(i) The corporate names of the buyer and any brokers.

(ii) A copy of any contracts related to the trade.

(iii) The averaging set corresponding to the engine families that generated emission credits for the trade, including the number of emission credits from each averaging set.

(2) As the buyer, you must include the following information in your report:

(i) The corporate names of the seller and any brokers.

(ii) A copy of any contracts related to the trade.

(iii) How you intend to use the emission credits, including the number of emission credits you intend to apply for each averaging set.

(e) Send your reports electronically to the Designated Compliance Officer using an approved information format. If you want to use a different format, send us a written request with justification for a waiver.

(f) Correct errors in your report as follows:

(1) If you or we determine by September 30 after the end of the model year that errors mistakenly decreased your balance of emission credits, you may correct the errors and recalculate the balance of emission credits. You may not make these corrections for errors that are determined later than September 30 after the end of the model year. If you report a negative balance of emission credits, we may disallow corrections under this paragraph (f)(1).

(2) If you or we determine any time that errors mistakenly increased your balance of emission credits, you must correct the errors and recalculate the balance of emission credits.

#### § 1036.735 Recordkeeping.

(a) You must organize and maintain your records as described in this section. We may review your records at any time.

(b) Keep the records required by this section for at least eight years after the due date for the end-of-year report. You may not use emission credits for any engines if you do not keep all the records required under this section. You must therefore keep these records to continue to bank valid credits. Store these records in any format and on any media, as long as you can promptly send us organized, written records in English if we ask for them. You must keep these records readily available. We may review them at any time.

(c) Keep a copy of the reports we require in §§ 1036.725 and 1036.730.

(d) Keep records of the engine identification number (usually the serial number) for each engine you produce that generates or uses emission credits under the ABT program. You may identify these numbers as a range. If you change the FEL/FCL after the start of production, identify the date you started using each FEL/FCL and the range of engine identification numbers associated with each FEL/FCL. You must also identify the purchaser and destination for each engine you produce to the extent this information is available.

(e) We may require you to keep additional records or to send us relevant information not required by this section in accordance with the Clean Air Act.

**§ 1036.740 Restrictions for using emission credits.**

The following restrictions apply for using emission credits:

(a) *Averaging sets.* Except as specified in paragraph (c) of this section, emission credits may be exchanged only within the following averaging sets based on primary intended service class:

- (1) Spark-ignition HDE.
- (2) Light HDE.
- (3) Medium HDE.
- (4) Heavy HDE.

(b) *Applying credits to prior year deficits.* Where your CO<sub>2</sub> credit balance for the previous year is negative, you may apply credits to that deficit only after meeting your credit obligations for the current year.

(c) *CO<sub>2</sub> credits from hybrid engines and other advanced technologies.* Phase 1 CO<sub>2</sub> credits you generate under § 1036.615 may be used for any of the averaging sets identified in paragraph (a) of this section; you may also use those credits to demonstrate compliance with the CO<sub>2</sub> emission standards in 40 CFR 86.1819 and 40 CFR part 1037. Similarly, you may use Phase 1 advanced-technology credits generated under 40 CFR 86.1819–14(k)(7) or 40 CFR 1037.615 to demonstrate compliance with the CO<sub>2</sub> standards in this part. In the case of Spark-ignition HDE and Light HDE you may not use more than 60,000 Mg of credits from other averaging sets in any model year.

(1) The maximum CO<sub>2</sub> credits you may bring into the following service class groups is 60,000 Mg per model year:

(i) Spark-ignition HDE, Light HDE, and Light HDV. This group comprises the averaging sets listed in paragraphs (a)(1) and (2) of this section and the averaging set listed in 40 CFR 1037.740(a)(1).

(ii) Medium HDE and Medium HDV. This group comprises the averaging sets listed in paragraph (a)(3) of this section and 40 CFR 1037.740(a)(2).

(iii) Heavy HDE and Heavy HDV. This group comprises the averaging sets listed in paragraph (a)(4) of this section and 40 CFR 1037.740(a)(3).

(2) Paragraph (c)(1) of this section does not limit the advanced-technology credits that can be used within a service class group if they were generated in that same service class group.

(d) *NO<sub>x</sub> and CO<sub>2</sub> credit life.* NO<sub>x</sub> and CO<sub>2</sub> credits may be used only for five model years after the year in which they are generated. For example, credits you generate in model year 2027 may be used to demonstrate compliance with emission standards only through model year 2032.

(e) *Other restrictions.* Other sections of this part specify additional restrictions for using emission credits under certain special provisions.

**§ 1036.745 End-of-year CO<sub>2</sub> credit deficits.**

Except as allowed by this section, we may void the certificate of any engine family certified to an FCL above the applicable standard for which you do not have sufficient credits by the deadline for submitting the final report.

(a) Your certificate for an engine family for which you do not have sufficient CO<sub>2</sub> credits will not be void if you remedy the deficit with surplus credits within three model years. For example, if you have a credit deficit of 500 Mg for an engine family at the end of model year 2015, you must generate (or otherwise obtain) a surplus of at least 500 Mg in that same averaging set by the end of model year 2018.

(b) You may not bank or trade away CO<sub>2</sub> credits in the averaging set in any model year in which you have a deficit.

(c) You may apply only surplus credits to your deficit. You may not apply credits to a deficit from an earlier model year if they were generated in a model year for which any of your engine families for that averaging set had an end-of-year credit deficit.

(d) You must notify us in writing how you plan to eliminate the credit deficit within the specified time frame. If we determine that your plan is unreasonable or unrealistic, we may deny an application for certification for a vehicle family if its FEL would increase your credit deficit. We may determine that your plan is unreasonable or unrealistic based on a consideration of past and projected use of specific technologies, the historical sales mix of your vehicle models, your commitment to limit production of higher-emission vehicles, and expected

access to traded credits. We may also consider your plan unreasonable if your credit deficit increases from one model year to the next. We may require that you send us interim reports describing your progress toward resolving your credit deficit over the course of a model year.

(e) If you do not remedy the deficit with surplus credits within three model years, we may void your certificate for that engine family. We may void the certificate based on your end-of-year report. Note that voiding a certificate applies *ab initio*. Where the net deficit is less than the total amount of negative credits originally generated by the family, we will void the certificate only with respect to the number of engines needed to reach the amount of the net deficit. For example, if the original engine family generated 500 Mg of negative credits, and the manufacturer's net deficit after three years was 250 Mg, we would void the certificate with respect to half of the engines in the family.

(f) For purposes of calculating the statute of limitations, the following actions are all considered to occur at the expiration of the deadline for offsetting a deficit as specified in paragraph (a) of this section:

(1) Failing to meet the requirements of paragraph (a) of this section.

(2) Failing to satisfy the conditions upon which a certificate was issued relative to offsetting a deficit.

(3) Selling, offering for sale, introducing or delivering into U.S. commerce, or importing vehicles that are found not to be covered by a certificate as a result of failing to offset a deficit.

**§ 1036.750 Consequences for noncompliance.**

(a) For each engine family participating in the ABT program, the certificate of conformity is conditioned upon full compliance with the provisions of this subpart during and after the model year. You are responsible to establish to our satisfaction that you fully comply with applicable requirements. We may void the certificate of conformity for an engine family if you fail to comply with any provisions of this subpart.

(b) You may certify your engine family to an FEL/FCL above an applicable standard based on a projection that you will have enough emission credits to offset the deficit for the engine family. See § 1036.745 for provisions specifying what happens if you cannot show in your final report that you have enough actual emission

credits to offset a deficit for any pollutant in an engine family.

(c) We may void the certificate of conformity for an engine family if you fail to keep records, send reports, or give us information we request. Note that failing to keep records, send reports, or give us information we request is also a violation of 42 U.S.C. 7522(a)(2).

(d) You may ask for a hearing if we void your certificate under this section (see § 1036.820).

#### **§ 1036.755 Information provided to the Department of Transportation.**

After receipt of each manufacturer's final report as specified in § 1036.730 and completion of any verification testing required to validate the manufacturer's submitted final data, we will issue a report to the Department of Transportation with CO<sub>2</sub> emission information and will verify the accuracy of each manufacturer's equivalent fuel consumption data that required by NHTSA under 49 CFR 535.8. We will send a report to DOT for each engine manufacturer based on each regulatory category and subcategory, including sufficient information for NHTSA to determine fuel consumption and associated credit values. See 49 CFR 535.8 to determine if NHTSA deems submission of this information to EPA to also be a submission to NHTSA.

#### **Subpart I—Definitions and Other Reference Information**

##### **§ 1036.801 Definitions.**

The following definitions apply to this part. The definitions apply to all subparts unless we note otherwise. All undefined terms have the meaning the Act gives to them. The definitions follow:

*Act* means the Clean Air Act, as amended, 42 U.S.C. 7401–7671q.

*Adjustable parameter* has the meaning given in 40 CFR 1068.50.

*Advanced technology* means technology certified under 40 CFR 86.1819–14(k)(7), § 1036.615, or 40 CFR 1037.615.

*Aftertreatment* means relating to a catalytic converter, particulate filter, or any other system, component, or technology mounted downstream of the exhaust valve (or exhaust port) whose design function is to decrease emissions in the engine exhaust before it is exhausted to the environment. Exhaust gas recirculation (EGR) and turbochargers are not aftertreatment.

*Aircraft* means any vehicle capable of sustained air travel more than 100 feet above the ground.

*Alcohol-fueled engine* mean an engine that is designed to run using an alcohol

fuel. For purposes of this definition, alcohol fuels do not include fuels with a nominal alcohol content below 25 percent by volume.

*Auxiliary emission control device* means any element of design that senses temperature, motive speed, engine speed (r/min), transmission gear, or any other parameter for the purpose of activating, modulating, delaying, or deactivating the operation of any part of the emission control system.

*Averaging set* has the meaning given in § 1036.740.

*Calibration* means the set of specifications and tolerances specific to a particular design, version, or application of a component or assembly capable of functionally describing its operation over its working range.

*Carryover* means relating to certification based on emission data generated from an earlier model year as described in § 1036.235(d).

*Certification* means relating to the process of obtaining a certificate of conformity for an engine family that complies with the emission standards and requirements in this part.

*Certified emission level* means the highest deteriorated emission level in an engine family for a given pollutant from the applicable transient and/or steady-state testing, rounded to the same number of decimal places as the applicable standard. Note that you may have two certified emission levels for CO<sub>2</sub> if you certify a family for both vocational and tractor use.

*Charge-depleting* has the meaning given in 40 CFR 1066.1001.

*Charge-sustaining* has the meaning given in 40 CFR 1066.1001.

*Complete vehicle* means a vehicle meeting the definition of complete vehicle in 40 CFR 1037.801 when it is first sold as a vehicle. For example, where a vehicle manufacturer sells an incomplete vehicle to a secondary vehicle manufacturer, the vehicle is not a complete vehicle under this part, even after its final assembly.

*Compression-ignition* means relating to a type of reciprocating, internal-combustion engine that is not a spark-ignition engine. Note that § 1036.1 also deems gas turbine engines and other engines to be compression-ignition engines.

*Crankcase emissions* means airborne substances emitted to the atmosphere from any part of the engine crankcase's ventilation or lubrication systems. The crankcase is the housing for the crankshaft and other related internal parts.

*Criteria pollutants* means emissions of NO<sub>x</sub>, HC, PM, and CO.

*Critical emission-related component* has the meaning given in 40 CFR 1068.30.

*Defeat device* has the meaning given in § 1036.115(h).

*Designated Compliance Officer* means one of the following:

(1) For engines subject to compression-ignition standards, *Designated Compliance Officer* means Director, Diesel Engine Compliance Center, U.S. Environmental Protection Agency, 2000 Traverwood Drive, Ann Arbor, MI 48105; [complianceinfo@epa.gov](mailto:complianceinfo@epa.gov); [www.epa.gov/ve-certification](http://www.epa.gov/ve-certification).

(2) For engines subject to spark-ignition standards, *Designated Compliance Officer* means Director, Gasoline Engine Compliance Center, U.S. Environmental Protection Agency, 2000 Traverwood Drive, Ann Arbor, MI 48105; [complianceinfo@epa.gov](mailto:complianceinfo@epa.gov); [www.epa.gov/ve-certification](http://www.epa.gov/ve-certification).

*Deteriorated emission level* means the emission level that results from applying the appropriate deterioration factor to the official emission result of the emission-data engine. Note that where no deterioration factor applies, references in this part to the *deteriorated emission level* mean the official emission result.

*Deterioration factor* means the relationship between emissions at the end of useful life (or point of highest emissions if it occurs before the end of useful life) and emissions at the low-hour/low-mileage point, expressed in one of the following ways:

(1) For multiplicative deterioration factors, the ratio of emissions at the end of useful life (or point of highest emissions) to emissions at the low-hour point.

(2) For additive deterioration factors, the difference between emissions at the end of useful life (or point of highest emissions) and emissions at the low-hour point.

*Diesel exhaust fluid (DEF)* means a liquid reducing agent (other than the engine fuel) used in conjunction with selective catalytic reduction to reduce NO<sub>x</sub> emissions. *Diesel exhaust fluid* is generally understood to be an aqueous solution of urea conforming to the specifications of ISO 22241.

*Dual-fuel* means relating to an engine designed for operation on two different types of fuel but not on a continuous mixture of those fuels (see § 1036.601(d)). For purposes of this part, such an engine remains a dual-fuel engine even if it is designed for operation on three or more different fuels.

*Electronic control module (ECM)* means an engine's electronic device that

uses data from engine sensors to control engine parameters.

*Emergency vehicle* has the meaning given in 40 CFR 1037.801.

*Emission control system* means any device, system, or element of design that controls or reduces the emissions of regulated pollutants from an engine.

*Emission-data engine* means an engine that is tested for certification. This includes engines tested to establish deterioration factors.

*Emission-related component* has the meaning given in 40 CFR part 1068, appendix A.

*Emission-related maintenance* means maintenance that substantially affects emissions or is likely to substantially affect emission deterioration.

*Engine configuration* means a unique combination of engine hardware and calibration (related to the emission standards) within an engine family, which would include hybrid components for engines certified as hybrid engines and hybrid powertrains. Engines within a single engine configuration differ only with respect to normal production variability or factors unrelated to compliance with emission standards.

*Engine family* has the meaning given in § 1036.230.

*Excluded* means relating to engines that are not subject to some or all of the requirements of this part as follows:

(1) An engine that has been determined not to be a heavy-duty engine is excluded from this part.

(2) Certain heavy-duty engines are excluded from the requirements of this part under § 1036.5.

(3) Specific regulatory provisions of this part may exclude a heavy-duty engine generally subject to this part from one or more specific standards or requirements of this part.

*Exempted* has the meaning given in 40 CFR 1068.30.

*Exhaust gas recirculation* means a technology that reduces emissions by routing exhaust gases that had been exhausted from the combustion chamber(s) back into the engine to be mixed with incoming air before or during combustion. The use of valve timing to increase the amount of residual exhaust gas in the combustion chamber(s) that is mixed with incoming air before or during combustion is not considered exhaust gas recirculation for the purposes of this part.

*Family certification level (FCL)* means a CO<sub>2</sub> emission level declared by the manufacturer that is at or above emission results for all emission-data engines. The FCL serves as the emission standard for the engine family with respect to certification testing if it is

different than the otherwise applicable standard.

*Family emission limit (FEL)* means one of the following:

(1) For NO<sub>x</sub> emissions, *family emission limit* means a NO<sub>x</sub> emission level declared by the manufacturer to serve in place of an otherwise applicable emission standard under the ABT program in subpart H of this part. The FEL serves as the emission standard for the engine family with respect to all required testing.

(2) For greenhouse gas standards, *family emission limit* means an emission level that serves as the standard that applies for testing individual certified engines. The CO<sub>2</sub> FEL is equal to the CO<sub>2</sub> FCL multiplied by 1.03 and rounded to the same number of decimal places as the standard.

*Federal Test Procedure (FTP)* means the applicable transient duty cycle described in § 1036.512 designed to measure exhaust emissions during urban driving.

*Flexible-fuel* means relating to an engine designed for operation on any mixture of two or more different types of fuels (see § 1036.601(d)).

*Fuel type* means a general category of fuels such as diesel fuel, gasoline, or natural gas. There can be multiple grades within a single fuel type, such as premium gasoline, regular gasoline, or gasoline with 10 percent ethanol.

*Good engineering judgment* has the meaning given in 40 CFR 1068.30. See 40 CFR 1068.5 for the administrative process we use to evaluate good engineering judgment.

*Greenhouse gas* means one or more compounds regulated under this part based primarily on their impact on the climate. This generally includes CO<sub>2</sub>, CH<sub>4</sub>, and N<sub>2</sub>O.

*Greenhouse gas Emissions Model (GEM)* means the GEM simulation tool described in 40 CFR 1037.520. Note that an updated version of GEM applies starting in model year 2021.

*Gross vehicle weight rating (GVWR)* means the value specified by the vehicle manufacturer as the maximum design loaded weight of a single vehicle, consistent with good engineering judgment.

*Heavy-duty engine* means any engine which the engine manufacturer could reasonably expect to be used for motive power in a heavy-duty vehicle. For purposes of this definition in this part, the term “engine” includes internal combustion engines and other devices that convert chemical fuel into motive power. For example, a gas turbine used in a heavy-duty vehicle is a heavy-duty engine.

*Heavy-duty vehicle* means any motor vehicle above 8,500 pounds GVWR. An incomplete vehicle is also a heavy-duty vehicle if it has a curb weight above 6,000 pounds or a basic vehicle frontal area greater than 45 square feet. *Curb weight* and *basic vehicle frontal area* have the meaning given in 40 CFR 86.1803–01.

*Hybrid* means an engine or powertrain that includes energy storage features other than a conventional battery system or conventional flywheel. Supplemental electrical batteries and hydraulic accumulators are examples of hybrid energy storage systems. Note that certain provisions in this part treat hybrid engines and hybrid powertrains intended for vehicles that include regenerative braking different than those intended for vehicles that do not include regenerative braking.

*Hybrid engine* means a hybrid system with features for storing and recovering energy that are integral to the engine or are otherwise upstream of the vehicle’s transmission other than a conventional battery system or conventional flywheel. Supplemental electrical batteries and hydraulic accumulators are examples of hybrid energy storage systems.

Examples of hybrids that could be considered hybrid engines are P0, P1, and P2 hybrids where hybrid features are connected to the front end of the engine, at the crankshaft, or connected between the clutch and the transmission where the clutch upstream of the hybrid feature is in addition to the transmission clutch(s), respectively. Note other examples of systems that qualify as hybrid engines are systems that recover kinetic energy and use it to power an electric heater in the aftertreatment.

*Hybrid powertrain* means a powertrain that includes energy storage features other than a conventional battery system or conventional flywheel. Supplemental electrical batteries and hydraulic accumulators are examples of hybrid energy storage systems. Note other examples of systems that qualify as hybrid powertrains are systems that recover kinetic energy and use it to power an electric heater in the aftertreatment.

*Hydrocarbon (HC)* has the meaning given in 40 CFR 1065.1001.

*Identification number* means a unique specification (for example, a model number/serial number combination) that allows someone to distinguish a particular engine from other similar engines.

*Incomplete vehicle* means a vehicle meeting the definition of incomplete vehicle in 40 CFR 1037.801 when it is first sold (or otherwise delivered to another entity) as a vehicle.

*Innovative technology* means technology certified under § 1036.610 (also described as “off-cycle technology”).

*Liquefied petroleum gas (LPG)* means a liquid hydrocarbon fuel that is stored under pressure and is composed primarily of nonmethane compounds that are gases at atmospheric conditions. Note that, although this commercial term includes the word “petroleum”, LPG is not considered to be a petroleum fuel under the definitions of this section.

*Low-hour* means relating to an engine that has stabilized emissions and represents the undeteriorated emission level. This would generally involve less than 300 hours of operation for engines with NO<sub>x</sub> aftertreatment and 125 hours of operation for other engines.

*Manufacture* means the physical and engineering process of designing, constructing, and/or assembling a heavy-duty engine or a heavy-duty vehicle.

*Manufacturer* has the meaning given in 40 CFR 1068.30.

*Medium-duty passenger vehicle* has the meaning given in 40 CFR 86.1803.

*Mild hybrid* means a hybrid engine or powertrain with regenerative braking capability where the system recovers less than 20 percent of the total braking energy over the transient cycle defined in appendix A of 40 CFR part 1037.

*Model year* means the manufacturer’s annual new model production period, except as restricted under this definition. It must include January 1 of the calendar year for which the model year is named, may not begin before January 2 of the previous calendar year, and it must end by December 31 of the named calendar year. Manufacturers may not adjust model years to circumvent or delay compliance with emission standards or to avoid the obligation to certify annually.

*Motorcoach* means a heavy-duty vehicle designed for carrying 30 or more passengers over long distances. Such vehicles are characterized by row seating, rest rooms, and large luggage compartments, and facilities for stowing carry-on luggage.

*Motor vehicle* has the meaning given in 40 CFR 85.1703.

*Natural gas* means a fuel whose primary constituent is methane.

*New motor vehicle engine* has the meaning given in the Act. This generally means a motor vehicle engine meeting any of the following:

(1) A motor vehicle engine for which the ultimate purchaser has never received the equitable or legal title is a *new motor vehicle engine*. This kind of engine might commonly be thought of

as “brand new” although a *new motor vehicle engine* may include previously used parts. Under this definition, the engine is new from the time it is produced until the ultimate purchaser receives the title or places it into service, whichever comes first.

(2) An imported motor vehicle engine is a *new motor vehicle engine* if it was originally built on or after January 1, 1970.

(3) Any motor vehicle engine installed in a new motor vehicle.

*Noncompliant engine* means an engine that was originally covered by a certificate of conformity, but is not in the certified configuration or otherwise does not comply with the conditions of the certificate.

*Nonconforming engine* means an engine not covered by a certificate of conformity that would otherwise be subject to emission standards.

*Nonmethane hydrocarbon (NMHC)* means the sum of all hydrocarbon species except methane, as measured according to 40 CFR part 1065.

*Nonmethane hydrocarbon equivalent (NMHCE)* has the meaning given in 40 CFR 1065.1001.

*Nonmethane nonethane hydrocarbon equivalent (NMNEHC)* has the meaning given in 40 CFR 1065.1001.

*Off-cycle technology* means technology certified under § 1036.610 (also described as “innovative technology”).

*Official emission result* means the measured emission rate for an emission-data engine on a given duty cycle before the application of any deterioration factor, but after the applicability of any required regeneration or other adjustment factors.

*Owners manual* means a document or collection of documents prepared by the engine or vehicle manufacturer for the owner or operator to describe appropriate engine maintenance, applicable warranties, and any other information related to operating or keeping the engine. The owners manual is typically provided to the ultimate purchaser at the time of sale. The owners manual may be in paper or electronic format.

*Oxides of nitrogen* has the meaning given in 40 CFR 1065.1001.

*Percent* has the meaning given in 40 CFR 1065.1001. Note that this means percentages identified in this part are assumed to be infinitely precise without regard to the number of significant figures. For example, one percent of 1,493 is 14.93.

*Placed into service* means put into initial use for its intended purpose, excluding incidental use by the manufacturer or a dealer.

*Preliminary approval* means approval granted by an authorized EPA representative prior to submission of an application for certification, consistent with the provisions of § 1036.210.

*Primary intended service class* has the meaning given in § 1036.140.

*Rechargeable Energy Storage System (RESS)* has the meaning given in 40 CFR 1065.1001.

*Relating to* as used in this section means relating to something in a specific, direct manner. This expression is used in this section only to define terms as adjectives and not to broaden the meaning of the terms.

*Revoke* has the meaning given in 40 CFR 1068.30.

*Round* has the meaning given in 40 CFR 1065.1001.

*Sample* means the collection of engines selected from the population of an engine family for emission testing. This may include testing for certification, production-line testing, or in-use testing.

*Scheduled maintenance* means adjusting, removing, disassembling, cleaning, or replacing components or systems periodically to keep a part or system from failing, malfunctioning, or wearing prematurely.

*Small manufacturer* means a manufacturer meeting the criteria specified in 13 CFR 121.201. The employee and revenue limits apply to the total number of employees and total revenue together for affiliated companies. Note that manufacturers with low production volumes may or may not be “small manufacturers”.

*Spark-ignition* means relating to a gasoline-fueled engine or any other type of engine with a spark plug (or other sparking device) and with operating characteristics significantly similar to the theoretical Otto combustion cycle. Spark-ignition engines usually use a throttle to regulate intake air flow to control power during normal operation.

*Steady-state* has the meaning given in 40 CFR 1065.1001. This includes fuel mapping and idle testing where engine speed and load are held at a finite set of nominally constant values.

*Suspend* has the meaning given in 40 CFR 1068.30.

*Test engine* means an engine in a sample.

*Tractor* means a vehicle meeting the definition of “tractor” in 40 CFR 1037.801, but not classified as a “vocational tractor” under 40 CFR 1037.630, or relating to such a vehicle.

*Tractor engine* means an engine certified for use in tractors. Where an engine family is certified for use in both tractors and vocational vehicles, “tractor engine” means an engine that the engine



manufacturer reasonably believes will be (or has been) installed in a tractor. Note that the provisions of this part may require a manufacturer to document how it determines that an engine is a tractor engine.

*Ultimate purchaser* means, with respect to any new engine or vehicle, the first person who in good faith purchases such new engine or vehicle for purposes other than resale.

*United States* has the meaning given in 40 CFR 1068.30.

*Upcoming model year* means for an engine family the model year after the one currently in production.

*U.S.-directed production volume* means the number of engines, subject to the requirements of this part, produced by a manufacturer for which the manufacturer has a reasonable assurance that sale was or will be made to ultimate purchasers in the United

States. This does not include engines certified to state emission standards that are different than the emission standards in this part.

*Vehicle* has the meaning given in 40 CFR 1037.801.

*Vocational engine* means an engine certified for use in vocational vehicles. Where an engine family is certified for use in both tractors and vocational vehicles, “vocational engine” means an engine that the engine manufacturer reasonably believes will be (or has been) installed in a vocational vehicle. Note that the provisions of this part may require a manufacturer to document how it determines that an engine is a vocational engine.

*Vocational vehicle* means a vehicle meeting the definition of “vocational” vehicle in 40 CFR 1037.801.

*Void* has the meaning given in 40 CFR 1068.30.

*We (us, our)* means the Administrator of the Environmental Protection Agency and any authorized representatives.

**§ 1036.805 Symbols, abbreviations, and acronyms.**

The procedures in this part generally follow either the International System of Units (SI) or the United States customary units, as detailed in NIST Special Publication 811 (incorporated by reference in § 1036.810). See 40 CFR 1065.20 for specific provisions related to these conventions. This section summarizes the way we use symbols, units of measure, and other abbreviations.

(a) *Symbols for chemical species.* This part uses the following symbols for chemical species and exhaust constituents:

TABLE 1 TO PARAGRAPH (a) OF § 1036.805—SYMBOLS FOR CHEMICAL SPECIES AND EXHAUST CONSTITUENTS

Symbol	Species
C	carbon.
CH <sub>4</sub>	methane.
CH <sub>4</sub> N <sub>2</sub> O	urea.
CO	carbon monoxide.
CO <sub>2</sub>	carbon dioxide.
H <sub>2</sub> O	water.
HC	hydrocarbon.
NMHC	nonmethane hydrocarbon.
NMHCE	nonmethane hydrocarbon equivalent.
NMNEHC	nonmethane nonethane hydrocarbon.
NO	nitric oxide.
NO <sub>2</sub>	nitrogen dioxide.
NO <sub>x</sub>	oxides of nitrogen.
N <sub>2</sub> O	nitrous oxide.
PM	particulate matter.

(b) *Symbols for quantities.* This part uses the following symbols and units of measure for various quantities:

TABLE 2 TO PARAGRAPH (b) OF § 1036.805—SYMBOLS FOR QUANTITIES

Symbol	Quantity	Unit	Unit symbol	Unit in terms of SI base units
$\alpha$	atomic hydrogen-to-carbon ratio	mole per mole	mol/mol	1
A	Area	square meter	m <sup>2</sup>	m <sup>2</sup>
$\beta$	atomic oxygen-to-carbon ratio	mole per mole	mol/mol	1
C <sub>d</sub> A	drag area	meter squared	m <sup>2</sup>	m <sup>2</sup>
C <sub>rr</sub>	coefficient of rolling resistance	newton per kilonewton	N/kN	10 <sup>-3</sup>
D	distance	miles or meters	mi or m	m
$\epsilon$	efficiency.			
$\epsilon$	Difference or error quantity.			
E	mass weighted emission result	grams/ton-mile	g/ton-mi	g/kg-km
Eff	efficiency.			
E <sub>m</sub>	mass-specific net energy content	megajoules/kilogram	MJ/kg	m <sup>2</sup> ·s <sup>-2</sup>
f <sub>n</sub>	angular speed (shaft)	revolutions per minute	r/min	$\pi \cdot 30 \cdot s^{-1}$
g	gravitational acceleration	meters per second squared	m/s <sup>2</sup>	m·s <sup>-2</sup>
i	indexing variable.			
k <sub>a</sub>	drive axle ratio			1
k <sub>topgear</sub>	highest available transmission gear.			
m	Mass	pound mass or kilogram	lbm or kg	kg
M	molar mass	gram per mole	g/mol	10 <sup>-3</sup> ·kg·mol <sup>-1</sup>
M	total number in a series.			

TABLE 2 TO PARAGRAPH (b) OF § 1036.805—SYMBOLS FOR QUANTITIES—Continued

Symbol	Quantity	Unit	Unit symbol	Unit in terms of SI base units
<i>M</i> .....	vehicle mass .....	kilogram .....	kg .....	kg
<i>M</i> <sub>rotating</sub> .....	inertial mass of rotating components .....	kilogram .....	kg .....	kg
<i>N</i> .....	total number in a series.			
<i>Q</i> .....	total number in a series.			
<i>P</i> .....	Power .....	kilowatt .....	kW .....	10 <sup>3</sup> ·m <sup>2</sup> ·kg·s <sup>-3</sup>
$\rho$ .....	mass density .....	kilogram per cubic meter .....	kg/m <sup>3</sup> .....	m <sup>-3</sup> ·kg
<i>r</i> .....	tire radius .....	meter .....	m .....	m
<i>SEE</i> .....	standard error of the estimate.			
$\sigma$ .....	standard deviation.			
<i>T</i> .....	torque (moment of force) .....	newton meter .....	N·m .....	m <sup>2</sup> ·kg·s <sup>-2</sup>
<i>t</i> .....	Time .....	second .....	s .....	s
$\Delta t$ .....	time interval, period, 1/frequency .....	second .....	s .....	s
<i>UF</i> .....	utility factor.			
<i>v</i> .....	Speed .....	miles per hour or meters per second .....	mi/hr or m/s .....	m·s <sup>-1</sup>
<i>W</i> .....	Work .....	kilowatt-hour .....	kW·hr .....	3.6·m <sup>2</sup> ·kg·s <sup>-1</sup>
<i>w</i> <sub>C</sub> .....	carbon mass fraction .....	gram/gram .....	g/g .....	1
<i>w</i> <sub>CH4N2O</sub> .....	urea mass fraction .....	gram/gram .....	g/g .....	1
<i>x</i> .....	amount of substance mole fraction .....	mole per mole .....	mol/mol .....	1
<i>x</i> <sub>b</sub> .....	brake energy fraction.			
<i>x</i> <sub>bl</sub> .....	brake energy limit.			

(c) *Superscripts.* This part uses the following superscripts for modifying quantity symbols:

TABLE 3 TO PARAGRAPH (c) OF § 1036.805—SUPERSCRIPTS

Superscript	Meaning
overbar (such as $\bar{y}$ ) .....	arithmetic mean.
overdot (such as $\dot{y}$ ) .....	quantity per unit time.

(d) *Subscripts.* This part uses the following subscripts for modifying quantity symbols:

TABLE 4 TO PARAGRAPH (d) OF § 1036.805—SUBSCRIPTS

Subscript	Meaning
65 .....	65 miles per hour.
A .....	A speed.
a .....	absolute (e.g., absolute difference or error).
acc .....	accessory.
app .....	approved.
axle .....	axle.
B .....	B speed.
C .....	C speed.
C .....	carbon mass.
C <sub>combdry</sub> .....	carbon from fuel per mole of dry exhaust.
CD .....	charge-depleting.
CO <sub>2</sub> DEF .....	CO <sub>2</sub> resulting from diesel exhaust fluid decomposition.
comb .....	combustion.
comp .....	composite.
cor .....	corrected.
CS .....	charge-sustaining.
cycle .....	cycle.
D .....	distance.
D .....	D speed.
DEF .....	diesel exhaust fluid.
engine .....	engine.
exh .....	raw exhaust.
front .....	frontal.
fuel .....	fuel.
H <sub>2</sub> O <sub>exhaustdry</sub> .....	H <sub>2</sub> O in exhaust per mole of exhaust.
hi .....	high.
i .....	an individual of a series.

TABLE 4 TO PARAGRAPH (d) OF § 1036.805—SUBSCRIPTS—Continued

Subscript	Meaning
idle .....	idle.
int .....	test interval.
j .....	an individual of a series.
k .....	an individual of a series.
m .....	mass.
max .....	maximum.
mapped .....	mapped.
meas .....	measured quantity.
MY .....	model year.
neg .....	negative.
pos .....	positive.
R .....	range.
r .....	relative ( <i>e.g.</i> , relative difference or error).
rate .....	rate (divided by time).
rated .....	rated.
record .....	record.
ref .....	reference quantity.
speed .....	speed.
stall .....	stall.
test .....	test.
tire .....	tire.
transient .....	transient.
μ .....	vector.
UF .....	utility factor.
vehicle .....	vehicle.

(e) *Other acronyms and abbreviations.*  
 This part uses the following additional abbreviations and acronyms:

TABLE 5 TO PARAGRAPH (e) OF § 1036.805—OTHER ACRONYMS AND ABBREVIATIONS

Acronym	Meaning
ABT .....	averaging, banking, and trading.
AECD .....	auxiliary emission control device.
ASTM .....	American Society for Testing and Materials.
BTU .....	British thermal units.
CD .....	charge-depleting.
CFR .....	Code of Federal Regulations.
CI .....	compression-ignition.
COV .....	coefficient of variation.
CS .....	charge-sustaining.
DEF .....	diesel exhaust fluid.
DF .....	deterioration factor.
DOT .....	Department of Transportation.
E85 .....	gasoline blend including nominally 85 percent denatured ethanol.
ECM .....	Electronic Control Module.
EGR .....	exhaust gas recirculation.
EPA .....	Environmental Protection Agency.
FCL .....	Family Certification Level.
FEL .....	family emission limit.
FTP .....	Federal Test Procedure.
GEM .....	Greenhouse gas Emissions Model.
g/hp-hr .....	grams per brake horsepower-hour.
GPS .....	global positioning system.
GVWR .....	gross vehicle weight rating.
Heavy HDE .....	heavy heavy-duty engine (see § 1036.140).
Heavy HDV .....	heavy heavy-duty vehicle (see 40 CFR 1037.140).
Light HDE .....	light heavy-duty engine (see § 1036.140).
Light HDV .....	light heavy-duty vehicle (see 40 CFR 1037.140).
LLC .....	Low Load Cycle.
LPG .....	liquefied petroleum gas.
Medium HDE .....	medium heavy-duty engine (see § 1036.140).
Medium HDV .....	medium heavy-duty vehicle (see 40 CFR 1037.140).
NARA .....	National Archives and Records Administration.
NHTSA .....	National Highway Traffic Safety Administration.
NTE .....	not-to-exceed.
PEMS .....	portable emission measurement system.
RESS .....	rechargeable energy storage system.

TABLE 5 TO PARAGRAPH (e) OF § 1036.805—OTHER ACRONYMS AND ABBREVIATIONS—Continued

Acronym	Meaning
SCR .....	selective catalytic reduction.
SEE .....	standard error of the estimate.
SET .....	Supplemental Emission Test.
Spark-ignition HDE .....	spark-ignition heavy-duty engine (see § 1036.140).
SI .....	spark-ignition.
UL .....	useful life.
U.S .....	United States.
U.S.C .....	United States Code.

(f) *Constants.* This part uses the following constants:

TABLE 6 TO PARAGRAPH (f) OF § 1036.805—CONSTANTS

Symbol	Quantity	Value
<i>g</i> .....	gravitational constant .....	9.80665 m·s <sup>-2</sup> .
<i>R</i> .....	molar gas constant .....	8.314472 J/(mol·K) (m <sup>2</sup> ·kg·s <sup>-2</sup> ·mol <sup>-1</sup> ·K <sup>-1</sup> ).

(g) *Prefixes.* This part uses the following prefixes to define a quantity:

TABLE 7 TO PARAGRAPH (g) OF § 1036.805—PREFIXES

Symbol	Quantity	Value
$\mu$ .....	micro .....	10 <sup>-6</sup>
m .....	milli .....	10 <sup>-3</sup>
c .....	centi .....	10 <sup>-2</sup>
k .....	kilo .....	10 <sup>3</sup>
M .....	mega .....	10 <sup>6</sup>

**§ 1036.810 Incorporation by reference.**

Certain material is incorporated by reference into this part with the approval of the Director of the Federal Register under 5 U.S.C. 552(a) and 1 CFR part 51. To enforce any edition other than that specified in this section, EPA must publish a document in the **Federal Register** and the material must be available to the public. All approved incorporation by reference (IBR) material is available for inspection at EPA and at the National Archives and Records Administration (NARA). Contact EPA at: U.S. EPA, Air and Radiation Docket Center, WJC West Building, Room 3334, 1301 Constitution Ave. NW, Washington, DC 20004; [www.epa.gov/dockets](http://www.epa.gov/dockets); (202) 202-1744. For information on inspecting this material at NARA, visit [www.archives.gov/federal-register/cfr/ibr-locations.html](http://www.archives.gov/federal-register/cfr/ibr-locations.html) or email [fr.inspection@nara.gov](mailto:fr.inspection@nara.gov). The material may be obtained from the following sources:

(a) ASTM International, 100 Barr Harbor Drive, P.O. Box C700, West Conshohocken, PA 19428-2959; (877) 909-2786; [www.astm.org](http://www.astm.org).

(1) ASTM D975-22, Standard Specification for Diesel Fuel, approved October 1, 2022 (“ASTM D975”); IBR approved for § 1036.415(c).

(2) ASTM D3588-98 (Reapproved 2017)e1, Standard Practice for Calculating Heat Value, Compressibility Factor, and Relative Density of Gaseous Fuels, approved April 1, 2017 (“ASTM D3588”); IBR approved for § 1036.550(b).

(3) ASTM D4809-18, Standard Test Method for Heat of Combustion of Liquid Hydrocarbon Fuels by Bomb Calorimeter (Precision Method), approved July 1, 2018 (“ASTM D4809”); IBR approved for § 1036.550(b).

(4) ASTM D4814-21c, Standard Specification for Automotive Spark-Ignition Engine Fuel, approved December 15, 2021 (“ASTM D4814”); IBR approved for § 1036.415(c).

(5) ASTM D7467-20a, Standard Specification for Diesel Fuel Oil, Biodiesel Blend (B6 to B20), approved June 1, 2020 (“ASTM D7467”); IBR approved for § 1036.415(c).

(b) National Institute of Standards and Technology (NIST), 100 Bureau Drive, Stop 1070, Gaithersburg, MD 20899-1070; (301) 975-6478; [www.nist.gov](http://www.nist.gov).

(1) NIST Special Publication 811, 2008 Edition, Guide for the Use of the International System of Units (SI), Physics Laboratory, March 2008; IBR approved for § 1036.805.

(2) [Reserved]

(c) SAE International, 400 Commonwealth Dr., Warrendale, PA 15096-0001; (877) 606-7323 (U.S. and Canada) or (724) 776-4970 (outside the U.S. and Canada); [www.sae.org](http://www.sae.org);

(1) SAE J1979-2 APR2021, E/E Diagnostic Test Modes: OBDonUDS, Issued April 2021, (“SAE J1979-2”); IBR approved for § 1036.150(v).

(2) [Reserved]

(d) State of California, Office of Administrative Law, 300 Capitol Mall, Suite 1250, Sacramento, CA 95814-4339; 916-323-6815; [staff@oal.ca.gov](mailto:staff@oal.ca.gov); [www.oal.ca.gov/publications/ccr](http://www.oal.ca.gov/publications/ccr).

(1) 2019 13 CCR 1968.2, Title 13. Motor Vehicles, Division 3. Air Resources Board, Chapter 1. Motor Vehicle Pollution Control Devices, Article 2. Approval of Motor Vehicle Pollution Control Devices (New Vehicles), § 1968.2. Malfunction and Diagnostic System Requirements—2004 and Subsequent Model-Year Passenger Cars, Light-Duty Trucks, and Medium-

Duty Vehicles and Engines, operative October 3, 2019 “13 CCR 1968.2”; into § 1036.110(b); 1036.111(a).

(2) 2019 13 CCR 1968.5, Title 13. Motor Vehicles, Division 3. Air Resources Board, Chapter 1. Motor Vehicle Pollution Control Devices, Article 2. Approval of Motor Vehicle Pollution Control Devices (New Vehicles), § 1968.5. Enforcement of Malfunction and Diagnostic System Requirements for 2004 and Subsequent Model-Year Passenger Cars, Light-Duty Trucks, and Medium-Duty Vehicles and Engines, operative July 25, 2016 “13 CCR 1968.5”; into § 1036.110(b).

(3) 2019 13 CCR 1971.1, Title 13. Motor Vehicles, Division 3. Air Resources Board, Chapter 1. Motor Vehicle Pollution Control Devices, Article 2. Approval of Motor Vehicle Pollution Control Devices (New Vehicles), § 1971.1. On-Board Diagnostic System Requirements—2010 and Subsequent Model-Year Heavy-Duty Engines, operative October 3, 2019 “13 CCR 1971.1”; into §§ 1036.110(b); 1036.111(a); 1036.150(v).

(4) 13 CA ADC 1971.5: 2019 CA REG TEXT 504962 (NS), 13 CA ADC 1971.5. Enforcement of Malfunction and Diagnostic System Requirements for 2010 and Subsequent Model-Year Heavy-Duty Engines, operative October 3, 2019 “13 CCR 1971.5”; into § 1036.110(b).

#### § 1036.815 Confidential information.

(a) The provisions of 40 CFR 1068.10 and 1068.11 apply for information you submit under this part.

(b) Emission data or information that is publicly available cannot be treated as confidential business information as described in 40 CFR 1068.11. Data that vehicle manufacturers need for demonstrating compliance with greenhouse gas emission standards, including fuel-consumption data as described in § 1036.535 and 40 CFR 1037.550, also qualify as emission data for purposes of confidentiality determinations.

#### § 1036.820 Requesting a hearing.

(a) You may request a hearing under certain circumstances, as described elsewhere in this part. To do this, you must file a written request, including a description of your objection and any supporting data, within 30 days after we make a decision.

(b) For a hearing you request under the provisions of this part, we will approve your request if we find that your request raises a substantial factual issue.

(c) If we agree to hold a hearing, we will use the procedures specified in 40 CFR part 1068, subpart G.

#### § 1036.825 Reporting and recordkeeping requirements.

(a) This part includes various requirements to submit and record data or other information. Unless we specify otherwise, store required records in any format and on any media and keep them readily available for eight years after you send an associated application for certification, or eight years after you generate the data if they do not support an application for certification. We may review these records at any time. You must promptly give us organized, written records in English if we ask for them. We may require you to submit written records in an electronic format.

(b) The regulations in § 1036.255 and 40 CFR 1068.25 and 1068.101 describe your obligation to report truthful and complete information. This includes information not related to certification. Failing to properly report information and keep the records we specify violates 40 CFR 1068.101(a)(2), which may involve civil or criminal penalties.

(c) Send all reports and requests for approval to the Designated Compliance Officer (see § 1036.801).

(d) Any written information we require you to send to or receive from another company is deemed to be a required record under this section. Such records are also deemed to be submissions to EPA. Keep these records for eight years unless the regulations specify a different period. We may require you to send us these records whether or not you are a certificate holder.

(e) Under the Paperwork Reduction Act (44 U.S.C. 3501 *et seq.*), the Office of Management and Budget approves the reporting and recordkeeping specified in the applicable regulations. The following items illustrate the kind of reporting and recordkeeping we require for engines and vehicles regulated under this part:

(1) We specify the following requirements related to engine certification in this part:

(i) In § 1036.135 we require engine manufacturers to keep certain records related to duplicate labels sent to vehicle manufacturers.

(ii) In § 1036.150 we include various reporting and recordkeeping requirements related to interim provisions.

(iii) In subpart C of this part we identify a wide range of information required to certify engines.

(iv) In §§ 1036.430 and 1036.435 we identify reporting and recordkeeping

requirements related to field testing in-use engines.

(v) In subpart G of this part we identify several reporting and recordkeeping items for making demonstrations and getting approval related to various special compliance provisions.

(vi) In §§ 1036.725, 1036.730, and 1036.735 we specify certain records related to averaging, banking, and trading.

(2) We specify the following requirements related to testing in 40 CFR part 1065:

(i) In 40 CFR 1065.2 we give an overview of principles for reporting information.

(ii) In 40 CFR 1065.10 and 1065.12 we specify information needs for establishing various changes to published procedures.

(iii) In 40 CFR 1065.25 we establish basic guidelines for storing information.

(iv) In 40 CFR 1065.695 we identify the specific information and data items to record when measuring emissions.

(3) We specify the following requirements related to the general compliance provisions in 40 CFR part 1068:

(i) In 40 CFR 1068.5 we establish a process for evaluating good engineering judgment related to testing and certification.

(ii) In 40 CFR 1068.25 we describe general provisions related to sending and keeping information

(iii) In 40 CFR 1068.27 we require manufacturers to make engines available for our testing or inspection if we make such a request.

(iv) In 40 CFR 1068.105 we require vehicle manufacturers to keep certain records related to duplicate labels from engine manufacturers.

(v) In 40 CFR 1068.120 we specify recordkeeping related to rebuilding engines.

(vi) In 40 CFR part 1068, subpart C, we identify several reporting and recordkeeping items for making demonstrations and getting approval related to various exemptions.

(vii) In 40 CFR part 1068, subpart D, we identify several reporting and recordkeeping items for making demonstrations and getting approval related to importing engines.

(viii) In 40 CFR 1068.450 and 1068.455 we specify certain records related to testing production-line engines in a selective enforcement audit.

(ix) In 40 CFR 1068.501 we specify certain records related to investigating and reporting emission-related defects.

(x) In 40 CFR 1068.525 and 1068.530 we specify certain records related to recalling nonconforming engines.

(xi) In 40 CFR part 1068, subpart G, we specify certain records for requesting a hearing.

**Appendix A of Part 1036—Summary of Previous Emission Standards**

The following standards, which EPA originally adopted under 40 CFR part 85 or part 86, apply to compression-ignition engines produced before model year 2007 and to spark-ignition engines produced before model year 2008:

(a) *Smoke*. Smoke standards applied for compression-ignition engines based on opacity measurement using the test procedures in 40 CFR part 86, subpart I, as follows:

(1) Engines were subject to the following smoke standards for model years 1970 through 1973:

(i) 40 percent during the engine acceleration mode.

(ii) 20 percent during the engine lugging mode.

(2) The smoke standards in 40 CFR 86.007–11 started to apply in model year 1974.

(b) *Idle CO*. A standard of 0.5 percent of exhaust gas flow at curb idle applied through model year 2016 to the following engines:

(1) Spark-ignition engines with aftertreatment starting in model year 1987. This standard applied only for gasoline-fueled engines through model year 1997. Starting in model year 1998, the same standard applied for engines fueled by methanol, LPG, and natural gas. The idle CO standard no longer applied for engines certified to meet onboard diagnostic requirements starting in model year 2005.

(2) Methanol-fueled compression-ignition engines starting in model year 1990. This standard also applied for natural gas and LPG engines starting in model year 1997. The idle CO standard no longer applied for engines

certified to meet onboard diagnostic requirements starting in model year 2007.

(c) *Crankcase emissions*. The requirement to design engines to prevent crankcase emissions applied starting with the following engines:

(1) Spark-ignition engines starting in model year 1968. This standard applied only for gasoline-fueled engines through model year 1989, and applied for spark-ignition engines using other fuels starting in model year 1990.

(2) Naturally aspirated diesel-fueled engines starting in model year 1985.

(3) Methanol-fueled compression-ignition engines starting in model year 1990.

(4) Naturally aspirated gaseous-fueled engines starting in model year 1997, and all other gaseous-fueled engines starting in 1998.

(d) *Early steady-state standards*. The following criteria standards applied to heavy-duty engines based on steady-state measurement procedures:

**TABLE 1 OF APPENDIX A—EARLY STEADY-STATE EMISSION STANDARDS FOR HEAVY-DUTY ENGINES**

Model year	Fuel	Pollutant		
		HC	NO <sub>x</sub> + HC	CO
1970–1973 .....	gasoline .....	275 ppm .....	.....	1.5 volume percent.
1974–1978 .....	gasoline and diesel .....	.....	16 g/hp-hr .....	40 g/hp-hr.
1979–1984 <sup>a</sup> .....	gasoline and diesel .....	.....	5 g/hp-hr for diesel; 5.0 g/hp-hr for gasoline.	25 g/hp-hr.

<sup>a</sup> An optional NO<sub>x</sub> + HC standard of 10 g/hp-hr applied in 1979 through 1984 in conjunction with a separate HC standard of 1.5 g/hp-hr.

(e) *Transient emission standards for spark-ignition engines*. The following criteria standards applied for spark-ignition engines

based on transient measurement using the test procedures in 40 CFR part 86, subpart N. Starting in model year 1991, manufacturers

could generate or use emission credits for NO<sub>x</sub> and NO<sub>x</sub> + NMHC standards. Table 2 to this appendix follows:

**TABLE 2 OF APPENDIX A—TRANSIENT EMISSION STANDARDS FOR SPARK-IGNITION ENGINES<sup>a b</sup>**

Model year	Pollutant (g/hp-hr)			
	HC	CO	NO <sub>x</sub>	NO <sub>x</sub> + NMHC
1985–1987 .....	1.1	14.4	10.6	.....
1988–1990 .....	1.1	14.4	6.0	.....
1991–1997 .....	1.1	14.4	5.0	.....
1998–2004 <sup>c</sup> .....	1.1	14.4	4.0	.....
2005–2007 .....	.....	14.4	.....	<sup>d</sup> 1.0

<sup>a</sup> Standards applied only for gasoline-fueled engines through model year 1989. Standards started to apply for methanol in model year 1990, and for LPG and natural gas in model year 1998.

<sup>b</sup> Engines intended for installation only in heavy-duty vehicles above 14,000 pounds GVWR were subject to an HC standard of 1.9 g/hp-hr for model years 1987 through 2004, and a CO standard of 37.1 g/hp-hr for model years 1987 through 2007. In addition, for model years 1987 through 2007, up to 5 percent of a manufacturer's sales of engines intended for installation in heavy-duty vehicles at or below 14,000 pounds GVWR could be certified to the alternative HC and CO standards.

<sup>c</sup> For natural gas engines in model years 1998 through 2004, the NO<sub>x</sub> standard was 5.0 g/hp-hr; the HC standards were 1.7 g/hp-hr for engines intended for installation only in vehicles above 14,000 pounds GVWR, and 0.9 g/hp-hr for other engines.

<sup>d</sup> Manufacturers could delay the 1.0 g/hp-hr NO<sub>x</sub> + NMHC standard until model year 2008 by meeting an alternate NO<sub>x</sub> + NMHC standard of 1.5 g/hp-hr applied for model years 2004 through 2007.

(f) *Transient emission standards for compression-ignition engines*. The following criteria standards applied for compression-ignition engines based on transient

measurement using the test procedures in 40 CFR part 86, subpart N. Starting in model year 1991, manufacturers could generate or use emission credits for NO<sub>x</sub>, NO<sub>x</sub> + NMHC,

and PM standards. Table 3 to this appendix follows:

TABLE 3 OF APPENDIX A—TRANSIENT EMISSION STANDARDS FOR COMPRESSION-IGNITION ENGINES <sup>a</sup>

Model year	Pollutant (g/hp·hr)				
	HC	CO	NO <sub>x</sub>	NO <sub>x</sub> + NMHC	PM
1985–1987 .....	1.3	15.5	10.7	.....	
1988–1989 .....	1.3	15.5	10.7	.....	0.60
1990 .....	1.3	15.5	6.0	.....	0.60
1991–1992 .....	1.3	15.5	5.0	.....	0.25
1993 .....	1.3	15.5	5.0	.....	0.25 truck, 0.10 bus.
1994–1995 .....	1.3	15.5	5.0	.....	0.10 truck, 0.07 urban bus.
1996–1997 .....	1.3	15.5	5.0	.....	0.10 truck, 0.05 urban bus. <sup>b</sup>
1998–2003 .....	1.3	15.5	4.0	.....	0.10 truck, 0.05 urban bus. <sup>b</sup>
2004–2006 .....	.....	15.5	.....	<sup>c</sup> 2.4	0.10 truck, 0.05 urban bus. <sup>b</sup>

<sup>a</sup> Standards applied only for diesel-fueled engines through model year 1989. Standards started to apply for methanol in model year 1990, and for LPG and natural gas in model year 1997. An alternate HC standard of 1.2 g/hp-hr applied for natural gas engines for model years 1997 through 2003.

<sup>b</sup> The in-use PM standard for urban bus engines in model years 1996 through 2006 was 0.07 g/hp-hr.

<sup>c</sup> An optional NO<sub>x</sub> + NMHC standard of 2.5 g/hp-hr applied in 2004 through 2006 in conjunction with a separate NMHC standard of 0.5 g/hp-hr.

**Appendix B of Part 1036—Transient Duty Cycles**

(a) This appendix specifies transient test intervals and duty cycles for the engine and powertrain testing described in §§ 1036.512 and 1036.514, as follows:

(1) The transient test intervals and duty cycle for testing engines involves a schedule of normalized engine speed and torque values.

(2) The transient test intervals and duty cycles for powertrain testing involves a

schedule of vehicle speeds and road grade. Determine road grade at each point based on the peak rated power of the powertrain system,  $P_{rated}$ , determined in § 1036.520 and road grade coefficients using the following equation:  $Road\ grade = a \cdot P_{rated}^2 + b \cdot P_{rated} + c$

(3) The operating schedules in this appendix in some cases eliminate repetitive information by omitting 1 Hz records where there is no change in values. Perform testing by continuing to operate at the last specified

values until the operating schedule shows a change in values. The official operating schedule for testing, cycle validation, and other purposes includes both the specified and omitted values.

(b) The following transient test interval applies for spark-ignition engines and powertrains when testing over the duty cycle specified in § 1036.512:

**Table 1 of Appendix B—Transient Test Interval for Spark-Ignition Engines and Powertrains Under § 1036.512**

Record (seconds)	Engine testing		Powertrain testing			
	Normalized revolutions per minute (percent)	Normalized torque (percent)	Vehicle speed (mi/hr)	Road grade coefficients		
				<i>a</i>	<i>b</i>	<i>c</i>
1	0	0	0	0	0	0
2	0	0	0	0	0	0
3	0	0	0	1.837E-05	-1.876E-02	2.369E+00
4	0	0	0	2.756E-05	-2.814E-02	3.553E+00
24	0	0	0	2.756E-05	-2.814E-02	3.553E+00
25	7	44.4	0	2.756E-05	-2.814E-02	3.553E+00
26	16	85.4	3.04	2.756E-05	-2.814E-02	3.553E+00
27	27	97.8	5.59	2.756E-05	-2.814E-02	3.553E+00
28	38	100	8.37	2.756E-05	-2.814E-02	3.553E+00
29	45	100	11.06	2.756E-05	-2.814E-02	3.553E+00
30	51	100	13.63	2.756E-05	-2.814E-02	3.553E+00
31	54	97.5	15.87	2.756E-05	-2.814E-02	3.553E+00
32	53	90	18.09	2.756E-05	-2.814E-02	3.553E+00
33	49	75.2	20.66	2.756E-05	-2.814E-02	3.553E+00
34	45	50	22.26	9.186E-06	-9.380E-03	1.184E+00
35	40	10	22.08	-9.186E-06	9.380E-03	-1.184E+00
36	34	2.3	20.58	-2.756E-05	2.814E-02	-3.553E+00
37	27	0	18.65	-2.756E-05	2.814E-02	-3.553E+00
38	21	2.3	16.5	-2.756E-05	2.814E-02	-3.553E+00
39	16	12	14.19	-2.756E-05	2.814E-02	-3.553E+00
40	12	35.3	11.65	-2.756E-05	2.814E-02	-3.553E+00
41	8.5	4.9	9.16	-2.756E-05	2.814E-02	-3.553E+00
42	5	( <sup>a</sup> )	8.01	-2.756E-05	2.814E-02	-3.553E+00
43	3	( <sup>a</sup> )	6.86	-2.756E-05	2.814E-02	-3.553E+00
44	0	0	3.19	-2.756E-05	2.814E-02	-3.553E+00
45	0	0	0	-2.756E-05	2.814E-02	-3.553E+00
46	0	0	0	-2.756E-05	2.814E-02	-3.553E+00
47	0	0	0	-1.587E-05	1.622E-02	-2.202E+00
48	0	0	0	-4.187E-06	4.310E-03	-8.511E-01
49	0	0	0	7.498E-06	-7.604E-03	5.001E-01
50	0	0	0	7.498E-06	-7.604E-03	5.001E-01
51	3	10	1.05	7.498E-06	-7.604E-03	5.001E-01
52	11	40.2	2.13	7.498E-06	-7.604E-03	5.001E-01



53	20	53	3.26	7.498E-06	-7.604E-03	5.001E-01
54	27.5	64.8	4.31	7.498E-06	-7.604E-03	5.001E-01
55	32	78	5.35	7.498E-06	-7.604E-03	5.001E-01
56	32	78	6.38	7.498E-06	-7.604E-03	5.001E-01
57	27.5	56	7.42	7.498E-06	-7.604E-03	5.001E-01
58	26	24.4	8.45	7.498E-06	-7.604E-03	5.001E-01
59	24	( <sup>e</sup> )	9.43	7.498E-06	-7.604E-03	5.001E-01
60	23	( <sup>e</sup> )	10.18	7.498E-06	-7.604E-03	5.001E-01
61	24	( <sup>e</sup> )	10.71	7.498E-06	-7.604E-03	5.001E-01
62	27	( <sup>e</sup> )	11.1	7.498E-06	-7.604E-03	5.001E-01
63	34	( <sup>e</sup> )	11.62	7.498E-06	-7.604E-03	5.001E-01
64	44	28	12.44	7.498E-06	-7.604E-03	5.001E-01
65	57	74.4	13.55	7.498E-06	-7.604E-03	5.001E-01
66	60	74.4	14.69	7.498E-06	-7.604E-03	5.001E-01
67	53	33.6	15.42	7.498E-06	-7.604E-03	5.001E-01
68	48	( <sup>e</sup> )	16.06	7.498E-06	-7.604E-03	5.001E-01
69	44	( <sup>e</sup> )	16.64	7.498E-06	-7.604E-03	5.001E-01
70	40	( <sup>e</sup> )	17.36	8.991E-06	-9.177E-03	2.234E+00
71	40	7	17.86	1.048E-05	-1.075E-02	3.968E+00
72	44	22.7	18.05	1.198E-05	-1.232E-02	5.701E+00
73	46	30	18.09	1.198E-05	-1.232E-02	5.701E+00
74	46	32	18.19	1.198E-05	-1.232E-02	5.701E+00
75	44	25	18.55	1.198E-05	-1.232E-02	5.701E+00
76	40	18	19.04	1.198E-05	-1.232E-02	5.701E+00
77	37	14	19.58	1.198E-05	-1.232E-02	5.701E+00
78	36	10	19.9	1.198E-05	-1.232E-02	5.701E+00
79	34	0	19.99	1.198E-05	-1.232E-02	5.701E+00
80	34	( <sup>e</sup> )	19.85	1.198E-05	-1.232E-02	5.701E+00
81	32	( <sup>e</sup> )	19.73	1.198E-05	-1.232E-02	5.701E+00
82	31	( <sup>e</sup> )	19.7	1.198E-05	-1.232E-02	5.701E+00
83	36	39.9	19.84	1.198E-05	-1.232E-02	5.701E+00
84	42	84.7	20.1	1.198E-05	-1.232E-02	5.701E+00
85	48	90	20.44	1.198E-05	-1.232E-02	5.701E+00
86	50	90	20.98	1.198E-05	-1.232E-02	5.701E+00
87	50	90	21.52	1.198E-05	-1.232E-02	5.701E+00
88	47	85	22.06	1.198E-05	-1.232E-02	5.701E+00
89	43	75	22.24	1.198E-05	-1.232E-02	5.701E+00
90	38	60	22.35	1.198E-05	-1.232E-02	5.701E+00
91	36	36	22.37	3.992E-06	-4.107E-03	1.900E+00
92	36	7.5	22.35	-3.992E-06	4.107E-03	-1.900E+00
93	36.3	( <sup>e</sup> )	22.27	-1.198E-05	1.232E-02	-5.701E+00
94	45	64.5	22.05	-1.198E-05	1.232E-02	-5.701E+00
95	53	67	21.79	-1.198E-05	1.232E-02	-5.701E+00
96	58	64.5	21.5	-1.198E-05	1.232E-02	-5.701E+00
97	62	60.3	21.2	-1.198E-05	1.232E-02	-5.701E+00
98	63	55.5	20.9	-1.198E-05	1.232E-02	-5.701E+00
99	62	52.3	20.59	-1.198E-05	1.232E-02	-5.701E+00
100	61	47	20.42	-1.198E-05	1.232E-02	-5.701E+00
101	55	44	20.25	-1.198E-05	1.232E-02	-5.701E+00
102	50	39	20.07	-1.198E-05	1.232E-02	-5.701E+00
103	45	36	19.75	-1.198E-05	1.232E-02	-5.701E+00
104	40	34	19.38	-1.198E-05	1.232E-02	-5.701E+00
105	36	30	19	-1.198E-05	1.232E-02	-5.701E+00
106	34	25.8	18.61	-1.198E-05	1.232E-02	-5.701E+00
107	32	20	18.2	-1.198E-05	1.232E-02	-5.701E+00
108	30	14.6	17.75	-1.198E-05	1.232E-02	-5.701E+00
109	26	10	17.27	-1.198E-05	1.232E-02	-5.701E+00
110	23	0	16.75	-1.198E-05	1.232E-02	-5.701E+00
111	18	( <sup>e</sup> )	16.2	-1.198E-05	1.232E-02	-5.701E+00
112	16	( <sup>e</sup> )	15.66	-1.198E-05	1.232E-02	-5.701E+00
113	18	( <sup>e</sup> )	15.15	-1.198E-05	1.232E-02	-5.701E+00
114	20	27.6	14.65	-1.198E-05	1.232E-02	-5.701E+00
115	17	4	14.16	-1.198E-05	1.232E-02	-5.701E+00
116	14	( <sup>e</sup> )	13.67	-1.198E-05	1.232E-02	-5.701E+00
117	12	( <sup>e</sup> )	12.59	-1.198E-05	1.232E-02	-5.701E+00
118	9	( <sup>e</sup> )	10.93	-1.198E-05	1.232E-02	-5.701E+00
119	7	( <sup>e</sup> )	9.28	-1.198E-05	1.232E-02	-5.701E+00
120	7	( <sup>e</sup> )	7.62	-1.198E-05	1.232E-02	-5.701E+00
121	5	( <sup>e</sup> )	5.96	-1.198E-05	1.232E-02	-5.701E+00
122	4	( <sup>e</sup> )	4.3	-1.198E-05	1.232E-02	-5.701E+00
123	3	( <sup>e</sup> )	2.64	-1.198E-05	1.232E-02	-5.701E+00
124	2	( <sup>e</sup> )	0.99	-1.198E-05	1.232E-02	-5.701E+00

125	0	0	0.19	-1.198E-05	1.232E-02	-5.701E+00
126	0	0	0	-1.198E-05	1.232E-02	-5.701E+00
127	0	0	0	-1.198E-05	1.232E-02	-5.701E+00
128	0	0	0	5.354E-07	1.492E-03	-6.315E+00
129	0	0	0	1.305E-05	-9.337E-03	-6.929E+00
130	5	8	3.25	2.556E-05	-2.017E-02	-7.543E+00
131	8	16.3	5.47	2.556E-05	-2.017E-02	-7.543E+00
132	10	27.5	6.71	2.556E-05	-2.017E-02	-7.543E+00
133	8	27.5	6.71	2.556E-05	-2.017E-02	-7.543E+00
134	5	9	6.71	2.556E-05	-2.017E-02	-7.543E+00
135	2	1.8	6.55	8.520E-06	-6.722E-03	-2.514E+00
136	0	0	6.01	-8.520E-06	6.722E-03	2.514E+00
137	0	0	5.15	-2.556E-05	2.017E-02	7.543E+00
138	0	0	3.9	-2.556E-05	2.017E-02	7.543E+00
139	0	0	2.19	-2.556E-05	2.017E-02	7.543E+00
140	0	0	0	-2.556E-05	2.017E-02	7.543E+00
141	0	0	0	-9.124E-06	5.441E-03	6.132E+00
142	0	0	0	7.313E-06	-9.284E-03	4.722E+00
143	0	0	0	2.375E-05	-2.401E-02	3.312E+00
148	0	0	0	2.375E-05	-2.401E-02	3.312E+00
149	2	4.8	0	2.375E-05	-2.401E-02	3.312E+00
150	1	4.5	0	2.375E-05	-2.401E-02	3.312E+00
151	0	0	0	2.375E-05	-2.401E-02	3.312E+00
166	0	0	0	2.375E-05	-2.401E-02	3.312E+00
167	8	27	1.95	2.375E-05	-2.401E-02	3.312E+00
168	18	65	3.7	2.375E-05	-2.401E-02	3.312E+00
169	23	82.5	5.53	2.375E-05	-2.401E-02	3.312E+00
170	23	88	7.22	2.375E-05	-2.401E-02	3.312E+00
171	21	88	8.64	2.375E-05	-2.401E-02	3.312E+00
172	18	81.3	10.33	2.375E-05	-2.401E-02	3.312E+00
173	17	32	11.18	7.917E-06	-8.003E-03	1.104E+00
174	15	( <sup>o</sup> )	10.57	-7.917E-06	8.003E-03	-1.104E+00
175	13	( <sup>o</sup> )	9.33	-2.375E-05	2.401E-02	-3.312E+00
176	11	( <sup>o</sup> )	7.87	-2.375E-05	2.401E-02	-3.312E+00
177	8	( <sup>o</sup> )	6.27	-2.375E-05	2.401E-02	-3.312E+00
178	6	( <sup>o</sup> )	4.58	-2.375E-05	2.401E-02	-3.312E+00
179	4	( <sup>o</sup> )	3.81	-2.375E-05	2.401E-02	-3.312E+00
180	2	( <sup>o</sup> )	2.35	-2.375E-05	2.401E-02	-3.312E+00
181	0	0	0	-2.375E-05	2.401E-02	-3.312E+00
182	0	0	0	-2.375E-05	2.401E-02	-3.312E+00
183	0	0	0	-1.078E-05	1.103E-02	-1.145E+00
184	0	0	0	2.190E-06	-1.954E-03	1.022E+00
185	0	0	0	1.516E-05	-1.494E-02	3.189E+00
203	0	0	0	1.516E-05	-1.494E-02	3.189E+00
204	0	4	0	1.516E-05	-1.494E-02	3.189E+00
205	0.5	7.7	1.6	1.516E-05	-1.494E-02	3.189E+00
206	5	14	4.24	1.516E-05	-1.494E-02	3.189E+00
207	11	24.7	7.5	1.516E-05	-1.494E-02	3.189E+00
208	15	42.3	9.18	1.516E-05	-1.494E-02	3.189E+00
209	16	70	10.11	1.516E-05	-1.494E-02	3.189E+00
210	17	70	10.34	1.516E-05	-1.494E-02	3.189E+00
211	17	50	10.46	1.516E-05	-1.494E-02	3.189E+00
212	16	26.3	9.93	1.516E-05	-1.494E-02	3.189E+00
213	14	5	8.7	1.516E-05	-1.494E-02	3.189E+00
214	10	( <sup>o</sup> )	7.43	1.516E-05	-1.494E-02	3.189E+00
215	10	( <sup>o</sup> )	9.14	1.516E-05	-1.494E-02	3.189E+00
216	14	73.3	9.72	1.516E-05	-1.494E-02	3.189E+00
217	18	83	9.84	1.516E-05	-1.494E-02	3.189E+00
218	19	84.8	10.02	1.516E-05	-1.494E-02	3.189E+00
219	18	84.8	9.92	5.053E-06	-4.979E-03	1.063E+00
220	16	82.8	9.14	-5.053E-06	4.979E-03	-1.063E+00
221	11	74	8.23	-1.516E-05	1.494E-02	-3.189E+00
222	7	8.5	6.64	-1.516E-05	1.494E-02	-3.189E+00
223	4	0	4.51	-1.516E-05	1.494E-02	-3.189E+00
224	0	0	0	-1.516E-05	1.494E-02	-3.189E+00
225	0	0	0	-1.516E-05	1.494E-02	-3.189E+00
226	0	0	0	-6.857E-06	6.357E-03	-2.057E+00
227	0	0	0	1.446E-06	-2.223E-03	-9.251E-01
228	0	0	0	9.749E-06	-1.080E-02	2.071E-01
232	0	0	0	9.749E-06	-1.080E-02	2.071E-01
233	6	17.6	0	9.749E-06	-1.080E-02	2.071E-01
234	6	19.6	0	9.749E-06	-1.080E-02	2.071E-01

235	5	14	0	9.749E-06	-1.080E-02	2.071E-01
236	3	9.8	0	9.749E-06	-1.080E-02	2.071E-01
237	1	5.5	0	9.749E-06	-1.080E-02	2.071E-01
238	0	3	0	9.749E-06	-1.080E-02	2.071E-01
239	0	0	0	9.749E-06	-1.080E-02	2.071E-01
280	0	0	0	9.749E-06	-1.080E-02	2.071E-01
281	0	7	0	9.749E-06	-1.080E-02	2.071E-01
282	1	10	0	9.749E-06	-1.080E-02	2.071E-01
283	2	11.5	0	9.749E-06	-1.080E-02	2.071E-01
284	1	10	0	9.749E-06	-1.080E-02	2.071E-01
285	0	0	0	9.749E-06	-1.080E-02	2.071E-01
298	0	0	0	9.749E-06	-1.080E-02	2.071E-01
299	0	28	0	9.749E-06	-1.080E-02	2.071E-01
300	0	30	0	9.749E-06	-1.080E-02	2.071E-01
301	2	32	0.55	9.749E-06	-1.080E-02	2.071E-01
302	6	34	1.92	9.749E-06	-1.080E-02	2.071E-01
303	14	36	3.18	9.749E-06	-1.080E-02	2.071E-01
304	19	36	4.8	9.749E-06	-1.080E-02	2.071E-01
305	24.5	36	6.63	9.749E-06	-1.080E-02	2.071E-01
306	24.5	36	7.87	9.749E-06	-1.080E-02	2.071E-01
307	24	30	8.32	9.749E-06	-1.080E-02	2.071E-01
308	19	24	9.66	9.749E-06	-1.080E-02	2.071E-01
309	13	18	11.46	9.749E-06	-1.080E-02	2.071E-01
310	9	14	13.28	9.749E-06	-1.080E-02	2.071E-01
311	7	8	14.61	9.749E-06	-1.080E-02	2.071E-01
312	6	0	14.39	9.749E-06	-1.080E-02	2.071E-01
313	4	3	13.5	9.749E-06	-1.080E-02	2.071E-01
314	3	6.8	12.41	9.749E-06	-1.080E-02	2.071E-01
315	0	0	11.3	9.749E-06	-1.080E-02	2.071E-01
316	0	0	11.25	9.749E-06	-1.080E-02	2.071E-01
317	0	0	12.29	9.749E-06	-1.080E-02	2.071E-01
318	0	0	13.26	9.749E-06	-1.080E-02	2.071E-01
319	0	0	13.66	9.749E-06	-1.080E-02	2.071E-01
320	0	0	14.27	9.749E-06	-1.080E-02	2.071E-01
321	0	0	15.17	9.749E-06	-1.080E-02	2.071E-01
322	0	0	16.05	9.749E-06	-1.080E-02	2.071E-01
323	0	18	16.49	9.749E-06	-1.080E-02	2.071E-01
324	3	40	17.52	9.749E-06	-1.080E-02	2.071E-01
325	8	86	18.06	9.749E-06	-1.080E-02	2.071E-01
326	18	97	18.18	9.749E-06	-1.080E-02	2.071E-01
327	38	100	18.95	9.749E-06	-1.080E-02	2.071E-01
328	45.5	100	20.48	9.749E-06	-1.080E-02	2.071E-01
329	45	96	20.48	3.250E-06	-3.601E-03	6.902E-02
330	44	84.4	19.5	-3.250E-06	3.601E-03	-6.902E-02
331	43	53.6	18.43	-9.749E-06	1.080E-02	-2.071E-01
332	41	5	17.44	-9.749E-06	1.080E-02	-2.071E-01
333	43	47.6	16.77	-9.749E-06	1.080E-02	-2.071E-01
334	44	90	16.36	-9.749E-06	1.080E-02	-2.071E-01
335	45	90	16.34	-9.749E-06	1.080E-02	-2.071E-01
336	44	73	16.79	-9.749E-06	1.080E-02	-2.071E-01
337	40	54	16.34	-9.749E-06	1.080E-02	-2.071E-01
338	38	34.7	15.13	-9.749E-06	1.080E-02	-2.071E-01
339	36	10	13.72	-9.749E-06	1.080E-02	-2.071E-01
340	35	10	12.04	-9.749E-06	1.080E-02	-2.071E-01
341	35	10	10.44	-9.749E-06	1.080E-02	-2.071E-01
342	35.5	60	9.71	-9.749E-06	1.080E-02	-2.071E-01
343	36	57.9	9.81	-9.749E-06	1.080E-02	-2.071E-01
344	37	53	10.65	-9.749E-06	1.080E-02	-2.071E-01
345	39	50	11.42	-9.749E-06	1.080E-02	-2.071E-01
346	40.5	50	10.54	-9.749E-06	1.080E-02	-2.071E-01
347	43	50	8.87	-9.749E-06	1.080E-02	-2.071E-01
348	45	50	9.26	-3.250E-06	3.601E-03	-6.902E-02
349	48	50	10.33	3.250E-06	-3.601E-03	6.902E-02
350	51	52	10.79	9.749E-06	-1.080E-02	2.071E-01
351	56	58.7	11.8	9.749E-06	-1.080E-02	2.071E-01
352	64	70	14.06	9.749E-06	-1.080E-02	2.071E-01
353	68	70	16.77	9.749E-06	-1.080E-02	2.071E-01
354	70	70	18.83	9.749E-06	-1.080E-02	2.071E-01
355	65.5	64.6	22.12	9.749E-06	-1.080E-02	2.071E-01
356	61	28.9	24.1	9.749E-06	-1.080E-02	2.071E-01
357	55	(°)	25.97	9.749E-06	-1.080E-02	2.071E-01
358	50	(°)	27.04	9.749E-06	-1.080E-02	2.071E-01

359	45	(°)	27.18	9.749E-06	-1.080E-02	2.071E-01
360	38	(°)	28.34	9.749E-06	-1.080E-02	2.071E-01
361	28	(°)	29.69	9.749E-06	-1.080E-02	2.071E-01
362	19	(°)	29.86	9.749E-06	-1.080E-02	2.071E-01
363	14	(°)	29.51	9.749E-06	-1.080E-02	2.071E-01
364	7	(°)	29.91	9.749E-06	-1.080E-02	2.071E-01
365	2	(°)	30.99	9.749E-06	-1.080E-02	2.071E-01
366	3	5	32.55	9.749E-06	-1.080E-02	2.071E-01
367	7	25	33.43	9.749E-06	-1.080E-02	2.071E-01
368	9	38	33.56	3.250E-06	-3.601E-03	6.902E-02
369	7	17	33.36	-3.250E-06	3.601E-03	-6.902E-02
370	4	2	32.65	-9.749E-06	1.080E-02	-2.071E-01
371	3	(°)	31.8	-9.749E-06	1.080E-02	-2.071E-01
372	3	(°)	30.92	-9.749E-06	1.080E-02	-2.071E-01
373	11	70	30.42	-9.749E-06	1.080E-02	-2.071E-01
374	15	97.6	29.73	-9.749E-06	1.080E-02	-2.071E-01
375	16	100	28.65	-9.749E-06	1.080E-02	-2.071E-01
376	19	100	27.5	-9.749E-06	1.080E-02	-2.071E-01
377	26	100	26.22	-9.749E-06	1.080E-02	-2.071E-01
378	29	95	24.69	-9.749E-06	1.080E-02	-2.071E-01
379	25	63	23.13	-9.749E-06	1.080E-02	-2.071E-01
380	19	(°)	21.68	-9.749E-06	1.080E-02	-2.071E-01
381	12	(°)	20.25	-9.749E-06	1.080E-02	-2.071E-01
382	8	(°)	15.73	-9.749E-06	1.080E-02	-2.071E-01
383	5	(°)	10.93	-9.749E-06	1.080E-02	-2.071E-01
384	2	(°)	6.12	-9.749E-06	1.080E-02	-2.071E-01
385	1	(°)	1.31	-9.749E-06	1.080E-02	-2.071E-01
386	0	0	0	-9.749E-06	1.080E-02	-2.071E-01
392	0	0	0	-9.749E-06	1.080E-02	-2.071E-01
393	0	0	0	-1.165E-06	1.625E-03	1.971E+00
394	0	0	0	7.420E-06	-7.553E-03	4.149E+00
395	0	0	0	1.600E-05	-1.673E-02	6.327E+00
418	0	0	0	1.600E-05	-1.673E-02	6.327E+00
419	4	20	0	1.600E-05	-1.673E-02	6.327E+00
420	4	20	0	1.600E-05	-1.673E-02	6.327E+00
421	0	0	0	1.600E-05	-1.673E-02	6.327E+00
429	0	0	0	1.600E-05	-1.673E-02	6.327E+00
430	2	0	1.18	1.600E-05	-1.673E-02	6.327E+00
431	6	2	2.85	1.600E-05	-1.673E-02	6.327E+00
432	14	28.8	4.57	1.600E-05	-1.673E-02	6.327E+00
433	20	30	7.42	1.600E-05	-1.673E-02	6.327E+00
434	24.4	11	10.79	1.600E-05	-1.673E-02	6.327E+00
435	24	10	13.51	1.600E-05	-1.673E-02	6.327E+00
436	24	12	15.48	1.600E-05	-1.673E-02	6.327E+00
437	28	52	16.82	1.600E-05	-1.673E-02	6.327E+00
438	32	52	17.86	1.600E-05	-1.673E-02	6.327E+00
439	34	46	18.7	1.600E-05	-1.673E-02	6.327E+00
440	34	30	19.11	1.600E-05	-1.673E-02	6.327E+00
441	34.5	30	19.28	1.600E-05	-1.673E-02	6.327E+00
442	35	30	19.38	1.600E-05	-1.673E-02	6.327E+00
443	36	35	19.53	1.600E-05	-1.673E-02	6.327E+00
444	39	40	19.57	1.600E-05	-1.673E-02	6.327E+00
445	45	50	19.09	1.600E-05	-1.673E-02	6.327E+00
446	49	56	18.2	1.600E-05	-1.673E-02	6.327E+00
447	50	(°)	17.14	1.600E-05	-1.673E-02	6.327E+00
448	45	(°)	15.9	1.600E-05	-1.673E-02	6.327E+00
449	39	(°)	14.42	1.600E-05	-1.673E-02	6.327E+00
450	34	(°)	13.86	1.600E-05	-1.673E-02	6.327E+00
451	28	(°)	15.45	1.600E-05	-1.673E-02	6.327E+00
452	25	(°)	17.32	1.600E-05	-1.673E-02	6.327E+00
453	21	(°)	18.03	1.600E-05	-1.673E-02	6.327E+00
454	18	(°)	18.19	1.600E-05	-1.673E-02	6.327E+00
455	15	(°)	18.3	1.600E-05	-1.673E-02	6.327E+00
456	12	(°)	18.4	1.600E-05	-1.673E-02	6.327E+00
457	18	(°)	18.33	1.600E-05	-1.673E-02	6.327E+00
458	29	19.8	18.68	1.600E-05	-1.673E-02	6.327E+00
459	40	54	19.1	5.335E-06	-5.577E-03	2.109E+00
460	52	82	18.69	-5.335E-06	5.577E-03	-2.109E+00
461	64	95	17.89	-1.600E-05	1.673E-02	-6.327E+00
462	71	99	17.23	-1.600E-05	1.673E-02	-6.327E+00
463	77	100	16.65	-1.600E-05	1.673E-02	-6.327E+00
464	84	100	15.76	-1.600E-05	1.673E-02	-6.327E+00

465	85	99	14.53	-1.600E-05	1.673E-02	-6.327E+00
466	85	95	13.07	-1.600E-05	1.673E-02	-6.327E+00
467	84	90	11.26	-1.600E-05	1.673E-02	-6.327E+00
468	82	84.6	9.32	-1.600E-05	1.673E-02	-6.327E+00
469	80	78.5	8.04	-1.600E-05	1.673E-02	-6.327E+00
470	78	78.5	8.15	-7.218E-06	7.554E-03	-2.785E+00
471	77	70	9.43	1.567E-06	-1.623E-03	7.568E-01
472	76	65.5	10.8	1.035E-05	-1.080E-02	4.299E+00
473	74	61.5	12.16	1.035E-05	-1.080E-02	4.299E+00
474	72	56	14.25	1.035E-05	-1.080E-02	4.299E+00
475	70	52	16.38	1.035E-05	-1.080E-02	4.299E+00
476	68	46	17.48	1.035E-05	-1.080E-02	4.299E+00
477	66.5	40	17.41	1.035E-05	-1.080E-02	4.299E+00
478	65	32	16.78	1.035E-05	-1.080E-02	4.299E+00
479	63	26	16.06	1.035E-05	-1.080E-02	4.299E+00
480	61	25.6	15.24	1.035E-05	-1.080E-02	4.299E+00
481	61	72	14.69	1.035E-05	-1.080E-02	4.299E+00
482	61	78	15.38	1.035E-05	-1.080E-02	4.299E+00
483	58	72	16.86	1.035E-05	-1.080E-02	4.299E+00
484	50	64	17.35	1.035E-05	-1.080E-02	4.299E+00
485	44	55	16.98	1.035E-05	-1.080E-02	4.299E+00
486	35	40	16.57	1.035E-05	-1.080E-02	4.299E+00
487	26	20	16.12	1.035E-05	-1.080E-02	4.299E+00
488	21	(°)	15.67	1.035E-05	-1.080E-02	4.299E+00
489	18	(°)	15.46	1.035E-05	-1.080E-02	4.299E+00
490	16	(°)	15.52	1.035E-05	-1.080E-02	4.299E+00
491	19	(°)	15.89	1.035E-05	-1.080E-02	4.299E+00
492	24	2	16.77	1.035E-05	-1.080E-02	4.299E+00
493	32	68.5	18.08	1.035E-05	-1.080E-02	4.299E+00
494	45	78	19.31	1.035E-05	-1.080E-02	4.299E+00
495	51	86	20.11	1.035E-05	-1.080E-02	4.299E+00
496	58	92	20.75	1.035E-05	-1.080E-02	4.299E+00
497	64	97	21.23	1.035E-05	-1.080E-02	4.299E+00
498	71	100	21.4	1.035E-05	-1.080E-02	4.299E+00
499	73	98	21.51	1.035E-05	-1.080E-02	4.299E+00
500	73	94	22.18	1.035E-05	-1.080E-02	4.299E+00
501	73	86	22.48	1.035E-05	-1.080E-02	4.299E+00
502	73	82	22.49	1.035E-05	-1.080E-02	4.299E+00
503	76	84	23.27	1.035E-05	-1.080E-02	4.299E+00
504	80	98	24.39	1.035E-05	-1.080E-02	4.299E+00
505	84	100	25.09	1.035E-05	-1.080E-02	4.299E+00
506	85	100	25.26	1.035E-05	-1.080E-02	4.299E+00
507	84	100	25.15	1.035E-05	-1.080E-02	4.299E+00
508	81	92	24.8	1.035E-05	-1.080E-02	4.299E+00
509	75	80	24.3	1.035E-05	-1.080E-02	4.299E+00
510	73	70	23.92	1.035E-05	-1.080E-02	4.299E+00
511	70	60	23.82	1.035E-05	-1.080E-02	4.299E+00
512	67	53	23.75	1.035E-05	-1.080E-02	4.299E+00
513	65	45	24.34	1.035E-05	-1.080E-02	4.299E+00
514	63	36.5	25.03	1.035E-05	-1.080E-02	4.299E+00
515	62	28	25.13	1.035E-05	-1.080E-02	4.299E+00
516	61	22.5	25.14	1.035E-05	-1.080E-02	4.299E+00
517	60	23	25.14	1.035E-05	-1.080E-02	4.299E+00
518	60	24	25.15	1.035E-05	-1.080E-02	4.299E+00
519	60	24	25.15	1.035E-05	-1.080E-02	4.299E+00
520	60	26	25.16	1.035E-05	-1.080E-02	4.299E+00
521	61	60	25.17	1.035E-05	-1.080E-02	4.299E+00
522	62	64	25.24	1.035E-05	-1.080E-02	4.299E+00
523	63	64	25.41	1.035E-05	-1.080E-02	4.299E+00
524	64	64	26.56	1.035E-05	-1.080E-02	4.299E+00
525	62	64	28.84	1.035E-05	-1.080E-02	4.299E+00
526	56	60	31.08	1.035E-05	-1.080E-02	4.299E+00
527	53	(°)	32.37	1.035E-05	-1.080E-02	4.299E+00
528	49	(°)	32.7	1.035E-05	-1.080E-02	4.299E+00
529	47	(°)	32.76	1.035E-05	-1.080E-02	4.299E+00
530	46	(°)	32.82	6.288E-06	-6.906E-03	2.331E+00
531	45	(°)	32.88	2.223E-06	-3.012E-03	3.623E-01
532	45	30	33.19	-1.842E-06	8.816E-04	-1.606E+00
533	46	50	33.89	-1.842E-06	8.816E-04	-1.606E+00
534	46	50	35.07	-1.842E-06	8.816E-04	-1.606E+00
535	47	50	36.61	-1.842E-06	8.816E-04	-1.606E+00
536	47	50	37.63	-1.842E-06	8.816E-04	-1.606E+00

537	47	30	38.05	-1.842E-06	8.816E-04	-1.606E+00
538	46	12	38.67	-1.842E-06	8.816E-04	-1.606E+00
539	45	10.5	39.32	-1.842E-06	8.816E-04	-1.606E+00
540	44	10	39.54	-1.842E-06	8.816E-04	-1.606E+00
541	41	10	39.55	-1.842E-06	8.816E-04	-1.606E+00
542	37	9	39.56	-1.842E-06	8.816E-04	-1.606E+00
543	36	2	39.58	-1.842E-06	8.816E-04	-1.606E+00
544	35	(°)	39.59	-1.842E-06	8.816E-04	-1.606E+00
545	38	67	39.61	-1.842E-06	8.816E-04	-1.606E+00
546	35	(°)	39.6	-1.842E-06	8.816E-04	-1.606E+00
547	31	15	39.69	-1.842E-06	8.816E-04	-1.606E+00
548	28	55	39.99	-1.842E-06	8.816E-04	-1.606E+00
549	34	44	40.39	-1.842E-06	8.816E-04	-1.606E+00
550	35	38.5	41.01	-1.842E-06	8.816E-04	-1.606E+00
551	36	38.5	41.65	-1.842E-06	8.816E-04	-1.606E+00
552	36	38.5	41.69	-1.842E-06	8.816E-04	-1.606E+00
553	37	38.5	41.17	-1.842E-06	8.816E-04	-1.606E+00
554	39	36	40.47	-1.842E-06	8.816E-04	-1.606E+00
555	42	27	39.83	-1.842E-06	8.816E-04	-1.606E+00
556	45	62	39.39	-1.842E-06	8.816E-04	-1.606E+00
557	48	45	39.14	-1.842E-06	8.816E-04	-1.606E+00
558	51	15	38.99	-1.842E-06	8.816E-04	-1.606E+00
559	51	8	38.88	-1.842E-06	8.816E-04	-1.606E+00
560	51	6	38.86	-1.842E-06	8.816E-04	-1.606E+00
561	48	10	39.17	-1.842E-06	8.816E-04	-1.606E+00
562	46	11	39.37	-6.139E-07	2.939E-04	-5.353E-01
563	44	13	38.63	6.139E-07	-2.939E-04	5.353E-01
564	41	17	36.96	1.842E-06	-8.816E-04	1.606E+00
565	37	20	34.87	1.842E-06	-8.816E-04	1.606E+00
566	34	20	32.73	1.842E-06	-8.816E-04	1.606E+00
567	30	17	30.53	1.842E-06	-8.816E-04	1.606E+00
568	26	14	28.27	1.842E-06	-8.816E-04	1.606E+00
569	23	7	26.02	1.842E-06	-8.816E-04	1.606E+00
570	19	2	23.76	1.842E-06	-8.816E-04	1.606E+00
571	15	(°)	21.37	1.842E-06	-8.816E-04	1.606E+00
572	11	(°)	18.79	1.842E-06	-8.816E-04	1.606E+00
573	8	(°)	16.06	1.842E-06	-8.816E-04	1.606E+00
574	5	(°)	13.05	1.842E-06	-8.816E-04	1.606E+00
575	2	(°)	9.54	1.842E-06	-8.816E-04	1.606E+00
576	0	0	4.59	1.842E-06	-8.816E-04	1.606E+00
577	0	0	0	1.842E-06	-8.816E-04	1.606E+00
580	0	0	0	1.842E-06	-8.816E-04	1.606E+00
581	0	0	0	8.289E-06	-7.507E-03	1.023E+00
582	0	0	0	1.474E-05	-1.413E-02	4.394E-01
583	4	15	0	2.118E-05	-2.076E-02	-1.439E-01
584	19	31	0.78	2.118E-05	-2.076E-02	-1.439E-01
585	30	46	1.94	2.118E-05	-2.076E-02	-1.439E-01
586	37	68	3.83	2.118E-05	-2.076E-02	-1.439E-01
587	40	76	5.98	2.118E-05	-2.076E-02	-1.439E-01
588	41	77	8.07	2.118E-05	-2.076E-02	-1.439E-01
589	40.5	78	10.09	2.118E-05	-2.076E-02	-1.439E-01
590	40	77	10.29	2.118E-05	-2.076E-02	-1.439E-01
591	40	64	7.34	2.118E-05	-2.076E-02	-1.439E-01
592	38	10	3.27	2.118E-05	-2.076E-02	-1.439E-01
593	38	25	3.24	2.118E-05	-2.076E-02	-1.439E-01
594	40	50	5.98	2.118E-05	-2.076E-02	-1.439E-01
595	40	36	8.48	2.118E-05	-2.076E-02	-1.439E-01
596	40	31	11	2.118E-05	-2.076E-02	-1.439E-01
597	40	31	13.62	2.118E-05	-2.076E-02	-1.439E-01
598	41	37	16.07	2.118E-05	-2.076E-02	-1.439E-01
599	42	97	18.51	2.118E-05	-2.076E-02	-1.439E-01
600	43	100	21.51	1.588E-05	-1.615E-02	-7.554E-01
601	45	100	24.71	1.058E-05	-1.153E-02	-1.367E+00
602	47	100	27.57	5.283E-06	-6.920E-03	-1.978E+00
603	48	100	30.04	5.283E-06	-6.920E-03	-1.978E+00
604	49	100	32.22	5.283E-06	-6.920E-03	-1.978E+00
605	51	97	34.28	5.283E-06	-6.920E-03	-1.978E+00
606	52	94	36.22	5.283E-06	-6.920E-03	-1.978E+00
607	53	90	38.08	5.283E-06	-6.920E-03	-1.978E+00
608	54	87	39.83	5.283E-06	-6.920E-03	-1.978E+00
609	56	86	41.63	5.283E-06	-6.920E-03	-1.978E+00
610	56	85	43.18	5.283E-06	-6.920E-03	-1.978E+00

611	55.5	85	44.33	5.283E-06	-6.920E-03	-1.978E+00
612	55	81	45.38	5.283E-06	-6.920E-03	-1.978E+00
613	54	77	46.14	5.283E-06	-6.920E-03	-1.978E+00
614	53	72	46.39	5.283E-06	-6.920E-03	-1.978E+00
615	52	67	46.34	5.283E-06	-6.920E-03	-1.978E+00
616	49	60	46.24	5.283E-06	-6.920E-03	-1.978E+00
617	46	45	46.14	5.283E-06	-6.920E-03	-1.978E+00
618	45	12	46.05	5.283E-06	-6.920E-03	-1.978E+00
619	44	10	46.13	5.283E-06	-6.920E-03	-1.978E+00
620	44	10	46.49	5.283E-06	-6.920E-03	-1.978E+00
621	45	12	46.78	5.283E-06	-6.920E-03	-1.978E+00
622	46	14	46.81	5.283E-06	-6.920E-03	-1.978E+00
623	47	24	46.95	5.283E-06	-6.920E-03	-1.978E+00
624	49	88	47.37	5.283E-06	-6.920E-03	-1.978E+00
625	50	90	47.62	2.349E-06	-3.713E-03	-1.409E+00
626	51	90	47.58	-5.848E-07	-5.058E-04	-8.401E-01
627	52	90	48	-3.519E-06	2.701E-03	-2.710E-01
628	53	90	48.46	-3.519E-06	2.701E-03	-2.710E-01
629	54	90	48.45	-3.519E-06	2.701E-03	-2.710E-01
630	54	90	48.4	-3.519E-06	2.701E-03	-2.710E-01
631	54	87	48.59	-3.519E-06	2.701E-03	-2.710E-01
632	54	84	49.3	-3.519E-06	2.701E-03	-2.710E-01
633	54	80	50.02	-3.519E-06	2.701E-03	-2.710E-01
634	53.5	77	50.27	-3.519E-06	2.701E-03	-2.710E-01
635	53	76	50	-3.519E-06	2.701E-03	-2.710E-01
636	53	75	49.73	-3.519E-06	2.701E-03	-2.710E-01
637	52	73	49.57	-3.519E-06	2.701E-03	-2.710E-01
638	51	69	49.31	-3.519E-06	2.701E-03	-2.710E-01
639	50	65	49.29	-3.519E-06	2.701E-03	-2.710E-01
640	50	60	49.71	-3.519E-06	2.701E-03	-2.710E-01
641	49	55	50.02	-3.519E-06	2.701E-03	-2.710E-01
642	49	50	50.05	-3.519E-06	2.701E-03	-2.710E-01
643	49	50	50.07	-3.519E-06	2.701E-03	-2.710E-01
644	49.5	60	50.33	-3.519E-06	2.701E-03	-2.710E-01
645	49.5	65	50.75	-3.519E-06	2.701E-03	-2.710E-01
646	50	70	51.03	-3.519E-06	2.701E-03	-2.710E-01
647	50.5	75	51.47	-3.519E-06	2.701E-03	-2.710E-01
648	51	80	51.92	-3.519E-06	2.701E-03	-2.710E-01
649	52	85	51.93	-3.519E-06	2.701E-03	-2.710E-01
650	53	90	51.9	-4.549E-06	3.697E-03	-6.366E-01
651	54	90	51.87	-5.579E-06	4.693E-03	-1.002E+00
652	55	90	51.85	-6.609E-06	5.688E-03	-1.368E+00
653	55	88	51.82	-6.609E-06	5.688E-03	-1.368E+00
654	55	84	51.82	-6.609E-06	5.688E-03	-1.368E+00
655	55	79	52.54	-6.609E-06	5.688E-03	-1.368E+00
656	55	74	53.59	-6.609E-06	5.688E-03	-1.368E+00
657	55	69	54.19	-6.609E-06	5.688E-03	-1.368E+00
658	55	64	54.26	-6.609E-06	5.688E-03	-1.368E+00
659	55	59	54.07	-6.609E-06	5.688E-03	-1.368E+00
660	55	54	53.93	-6.609E-06	5.688E-03	-1.368E+00
661	55	49	53.92	-6.609E-06	5.688E-03	-1.368E+00
662	55	44.5	53.9	-6.609E-06	5.688E-03	-1.368E+00
663	55	39	53.89	-6.609E-06	5.688E-03	-1.368E+00
664	55	34	53.88	-6.609E-06	5.688E-03	-1.368E+00
665	55	27	53.87	-6.609E-06	5.688E-03	-1.368E+00
666	55	18	53.85	-6.609E-06	5.688E-03	-1.368E+00
667	55	8	53.81	-6.609E-06	5.688E-03	-1.368E+00
668	55	6	53.67	-6.609E-06	5.688E-03	-1.368E+00
669	55	13	53.67	-6.609E-06	5.688E-03	-1.368E+00
670	55	27	54.32	-6.609E-06	5.688E-03	-1.368E+00
671	55.5	30	54.88	-6.609E-06	5.688E-03	-1.368E+00
672	56	30	54.87	-6.609E-06	5.688E-03	-1.368E+00
673	57	30	54.86	-6.609E-06	5.688E-03	-1.368E+00
674	58	34	54.75	-6.609E-06	5.688E-03	-1.368E+00
675	59	46	54.28	-5.500E-06	4.582E-03	-7.225E-01
676	59	89	53.84	-4.390E-06	3.477E-03	-7.706E-02
677	59	90	54.02	-3.280E-06	2.371E-03	5.683E-01
678	59	91	54.48	-3.280E-06	2.371E-03	5.683E-01
679	59	91	54.76	-3.280E-06	2.371E-03	5.683E-01
680	60	91	54.84	-3.280E-06	2.371E-03	5.683E-01
681	60	91	54.87	-3.280E-06	2.371E-03	5.683E-01
682	60.5	90	54.9	-3.280E-06	2.371E-03	5.683E-01

683	61	89	54.93	-3.280E-06	2.371E-03	5.683E-01
684	61.5	88	54.97	-3.280E-06	2.371E-03	5.683E-01
685	62	83	55	-3.280E-06	2.371E-03	5.683E-01
686	63	73	55.03	-3.280E-06	2.371E-03	5.683E-01
687	65	70	55.06	-3.280E-06	2.371E-03	5.683E-01
688	66	71	55.1	-3.280E-06	2.371E-03	5.683E-01
689	67	74	55.12	-3.280E-06	2.371E-03	5.683E-01
690	67.5	79	55.15	-3.280E-06	2.371E-03	5.683E-01
691	68	85	55.16	-3.280E-06	2.371E-03	5.683E-01
692	68.5	90	55.18	-3.280E-06	2.371E-03	5.683E-01
693	69	94	55.33	-3.280E-06	2.371E-03	5.683E-01
694	69.5	96	55.85	-3.280E-06	2.371E-03	5.683E-01
695	70	98	56.52	-3.280E-06	2.371E-03	5.683E-01
696	70.5	100	57.05	-3.280E-06	2.371E-03	5.683E-01
697	71	100	57.31	-3.280E-06	2.371E-03	5.683E-01
698	72	100	57.35	-3.280E-06	2.371E-03	5.683E-01
699	72	100	57.34	-3.280E-06	2.371E-03	5.683E-01
700	72	100	57.34	-2.967E-06	2.047E-03	8.641E-01
701	72	100	57.33	-2.653E-06	1.723E-03	1.160E+00
702	72	100	57.33	-2.340E-06	1.399E-03	1.456E+00
703	72	100	57.33	-2.340E-06	1.399E-03	1.456E+00
704	72	100	57.32	-2.340E-06	1.399E-03	1.456E+00
705	72	100	57.31	-2.340E-06	1.399E-03	1.456E+00
706	72	100	57.3	-2.340E-06	1.399E-03	1.456E+00
707	72.5	100	57.39	-2.340E-06	1.399E-03	1.456E+00
708	73	100	57.71	-2.340E-06	1.399E-03	1.456E+00
709	73.5	100	58.14	-2.340E-06	1.399E-03	1.456E+00
710	74	100	58.34	-2.340E-06	1.399E-03	1.456E+00
711	74	100	58.34	-2.340E-06	1.399E-03	1.456E+00
712	74.5	100	58.33	-2.340E-06	1.399E-03	1.456E+00
713	75	100	58.33	-2.340E-06	1.399E-03	1.456E+00
714	75	100	58.32	-2.340E-06	1.399E-03	1.456E+00
715	75	100	58.31	-2.340E-06	1.399E-03	1.456E+00
716	75	100	58.3	-2.340E-06	1.399E-03	1.456E+00
717	75	100	58.3	-2.340E-06	1.399E-03	1.456E+00
718	75	100	58.3	-2.340E-06	1.399E-03	1.456E+00
719	75	100	58.3	-2.340E-06	1.399E-03	1.456E+00
720	75	100	58.48	-2.340E-06	1.399E-03	1.456E+00
721	75	100	58.92	-2.340E-06	1.399E-03	1.456E+00
722	75	100	59.26	-2.340E-06	1.399E-03	1.456E+00
723	75	98	59.34	-2.340E-06	1.399E-03	1.456E+00
724	75	90	59.32	-2.340E-06	1.399E-03	1.456E+00
725	75	34	59.37	-3.622E-06	2.640E-03	9.220E-01
726	74	15	59.67	-4.905E-06	3.881E-03	3.883E-01
727	72	3	60.11	-6.187E-06	5.122E-03	-1.455E-01
728	70	( <sup>c</sup> )	60.32	-6.187E-06	5.122E-03	-1.455E-01
729	69	( <sup>c</sup> )	60.3	-6.187E-06	5.122E-03	-1.455E-01
730	68	( <sup>c</sup> )	60.29	-6.187E-06	5.122E-03	-1.455E-01
731	70.5	53	60.27	-6.187E-06	5.122E-03	-1.455E-01
732	73	80	60.26	-6.187E-06	5.122E-03	-1.455E-01
733	75	88	60.25	-6.187E-06	5.122E-03	-1.455E-01
734	77	94	60.18	-6.187E-06	5.122E-03	-1.455E-01
735	79	97	59.83	-6.187E-06	5.122E-03	-1.455E-01
736	82	97	59.36	-6.187E-06	5.122E-03	-1.455E-01
737	85	98	59.65	-6.187E-06	5.122E-03	-1.455E-01
738	85	98	60.12	-6.187E-06	5.122E-03	-1.455E-01
739	87	97	59.8	-6.187E-06	5.122E-03	-1.455E-01
740	90	95	59.82	-6.187E-06	5.122E-03	-1.455E-01
741	92	90	60.18	-6.187E-06	5.122E-03	-1.455E-01
742	93	88	60.27	-6.187E-06	5.122E-03	-1.455E-01
743	94	86	60.31	-6.187E-06	5.122E-03	-1.455E-01
744	95	83	60.35	-6.187E-06	5.122E-03	-1.455E-01
745	96	79	60.37	-6.187E-06	5.122E-03	-1.455E-01
746	97	74	60.35	-6.187E-06	5.122E-03	-1.455E-01
747	98	68	60.33	-6.187E-06	5.122E-03	-1.455E-01
748	99	62	60.3	-6.187E-06	5.122E-03	-1.455E-01
749	100	54	60.26	-6.187E-06	5.122E-03	-1.455E-01
750	100	30	60.45	-7.791E-06	6.722E-03	-9.485E-01
751	100	22	61.12	-9.395E-06	8.322E-03	-1.752E+00
752	100	20	61.91	-1.100E-05	9.923E-03	-2.555E+00
753	100	22	62.23	-1.100E-05	9.923E-03	-2.555E+00
754	100	30	62.19	-1.100E-05	9.923E-03	-2.555E+00



755	100	65	62.17	-1.100E-05	9.923E-03	-2.555E+00
756	100	76	62.19	-1.100E-05	9.923E-03	-2.555E+00
757	100	80	62.24	-1.100E-05	9.923E-03	-2.555E+00
758	100	78	62.28	-1.100E-05	9.923E-03	-2.555E+00
759	100	72	62.3	-1.100E-05	9.923E-03	-2.555E+00
760	100	54	62.79	-1.100E-05	9.923E-03	-2.555E+00
761	95	30	63.22	-1.100E-05	9.923E-03	-2.555E+00
762	85	12	63.11	-1.100E-05	9.923E-03	-2.555E+00
763	68	(°)	62.97	-1.100E-05	9.923E-03	-2.555E+00
764	57	(°)	62.82	-1.100E-05	9.923E-03	-2.555E+00
765	56	(°)	62.67	-1.100E-05	9.923E-03	-2.555E+00
766	57	(°)	62.52	-1.100E-05	9.923E-03	-2.555E+00
767	57	(°)	62.37	-1.100E-05	9.923E-03	-2.555E+00
768	57	22	62.32	-1.100E-05	9.923E-03	-2.555E+00
769	58	40	62.45	-1.100E-05	9.923E-03	-2.555E+00
770	59	45	62.64	-1.100E-05	9.923E-03	-2.555E+00
771	59	46	62.69	-1.100E-05	9.923E-03	-2.555E+00
772	59.5	45	62.66	-1.100E-05	9.923E-03	-2.555E+00
773	60	33	62.62	-1.100E-05	9.923E-03	-2.555E+00
774	60	0	62.59	-1.100E-05	9.923E-03	-2.555E+00
775	60	(°)	62.55	-1.027E-05	9.176E-03	-2.095E+00
776	60	(°)	62.51	-9.541E-06	8.429E-03	-1.636E+00
777	60	34	62.44	-8.813E-06	7.683E-03	-1.177E+00
778	60	50	62.37	-8.813E-06	7.683E-03	-1.177E+00
779	60	60	62.29	-8.813E-06	7.683E-03	-1.177E+00
780	60	69	62.21	-8.813E-06	7.683E-03	-1.177E+00
781	60	75	62.15	-8.813E-06	7.683E-03	-1.177E+00
782	60	79	62.46	-8.813E-06	7.683E-03	-1.177E+00
783	61	83	63.4	-8.813E-06	7.683E-03	-1.177E+00
784	61	84	63.97	-8.813E-06	7.683E-03	-1.177E+00
785	61	85	63.98	-8.813E-06	7.683E-03	-1.177E+00
786	62	85	63.94	-8.813E-06	7.683E-03	-1.177E+00
787	62	85	63.93	-8.813E-06	7.683E-03	-1.177E+00
788	62	85	63.92	-8.813E-06	7.683E-03	-1.177E+00
789	63	85	63.92	-8.813E-06	7.683E-03	-1.177E+00
790	63	85	63.91	-8.813E-06	7.683E-03	-1.177E+00
791	64	85	64.21	-8.813E-06	7.683E-03	-1.177E+00
792	64	85	64.61	-8.813E-06	7.683E-03	-1.177E+00
793	64	85	64.5	-8.813E-06	7.683E-03	-1.177E+00
794	64	85	64.05	-8.813E-06	7.683E-03	-1.177E+00
795	64	85	63.83	-8.813E-06	7.683E-03	-1.177E+00
796	64	84.5	63.81	-8.813E-06	7.683E-03	-1.177E+00
797	64	84	63.79	-8.813E-06	7.683E-03	-1.177E+00
798	64	83	63.77	-8.813E-06	7.683E-03	-1.177E+00
799	64	82	63.76	-8.813E-06	7.683E-03	-1.177E+00
800	64	81	63.75	-8.873E-06	7.725E-03	-1.104E+00
801	64	77	63.73	-8.933E-06	7.767E-03	-1.032E+00
802	64	72	63.72	-8.993E-06	7.810E-03	-9.592E-01
803	65	67	63.7	-8.993E-06	7.810E-03	-9.592E-01
804	66	64	63.69	-8.993E-06	7.810E-03	-9.592E-01
805	67	60	63.69	-8.993E-06	7.810E-03	-9.592E-01
806	69	62.3	63.68	-8.993E-06	7.810E-03	-9.592E-01
807	72	84	64.1	-8.993E-06	7.810E-03	-9.592E-01
808	73	90.5	64.6	-8.993E-06	7.810E-03	-9.592E-01
809	74	91	64.73	-8.993E-06	7.810E-03	-9.592E-01
810	74	90	64.73	-8.993E-06	7.810E-03	-9.592E-01
811	74	84.5	64.73	-8.993E-06	7.810E-03	-9.592E-01
812	73	74	64.72	-8.993E-06	7.810E-03	-9.592E-01
813	72	66	64.71	-8.993E-06	7.810E-03	-9.592E-01
814	71	60	64.71	-8.993E-06	7.810E-03	-9.592E-01
815	70	54	64.7	-8.993E-06	7.810E-03	-9.592E-01
816	69	50	64.69	-8.993E-06	7.810E-03	-9.592E-01
817	68	49	64.68	-8.993E-06	7.810E-03	-9.592E-01
818	68	48	64.82	-8.993E-06	7.810E-03	-9.592E-01
819	68	48	65.27	-8.993E-06	7.810E-03	-9.592E-01
820	68	48.5	65.65	-8.993E-06	7.810E-03	-9.592E-01
821	68	49	65.71	-8.993E-06	7.810E-03	-9.592E-01
822	68	51	65.72	-8.993E-06	7.810E-03	-9.592E-01
823	68	53.5	65.72	-8.993E-06	7.810E-03	-9.592E-01
824	68	55	65.72	-8.993E-06	7.810E-03	-9.592E-01
825	68	58	65.71	-8.993E-06	7.810E-03	-9.592E-01
826	68	60	65.7	-8.993E-06	7.810E-03	-9.592E-01

827	68	62	65.69	-8.993E-06	7.810E-03	-9.592E-01
828	68	64	65.67	-8.993E-06	7.810E-03	-9.592E-01
829	68	67	65.27	-8.993E-06	7.810E-03	-9.592E-01
830	69	68.5	64.33	-8.993E-06	7.810E-03	-9.592E-01
831	70	70	63.65	-8.993E-06	7.810E-03	-9.592E-01
832	70	70	63.5	-8.993E-06	7.810E-03	-9.592E-01
833	70	70	63.49	-8.993E-06	7.810E-03	-9.592E-01
834	70	70	63.49	-8.993E-06	7.810E-03	-9.592E-01
835	70	70	63.37	-8.993E-06	7.810E-03	-9.592E-01
836	70	70	63.01	-8.993E-06	7.810E-03	-9.592E-01
837	71	66	62.6	-8.993E-06	7.810E-03	-9.592E-01
838	73	64	62.44	-8.993E-06	7.810E-03	-9.592E-01
839	75	64	62.45	-8.993E-06	7.810E-03	-9.592E-01
840	77	98	62.47	-5.933E-06	4.759E-03	5.464E-01
841	79	100	62.5	-2.873E-06	1.709E-03	2.052E+00
842	81	100	62.52	1.865E-07	-1.342E-03	3.558E+00
843	82	100	62.54	1.865E-07	-1.342E-03	3.558E+00
844	83	100	62.57	1.865E-07	-1.342E-03	3.558E+00
845	84	98	62.7	1.865E-07	-1.342E-03	3.558E+00
846	84	94	62.9	1.865E-07	-1.342E-03	3.558E+00
847	85	93	63.11	1.865E-07	-1.342E-03	3.558E+00
848	86	94	63.32	1.865E-07	-1.342E-03	3.558E+00
849	87	98	63.53	1.865E-07	-1.342E-03	3.558E+00
850	89	100	63.74	1.865E-07	-1.342E-03	3.558E+00
851	92	100	62.2	1.865E-07	-1.342E-03	3.558E+00
852	95	100	62.67	1.865E-07	-1.342E-03	3.558E+00
853	97.5	100	63.19	1.865E-07	-1.342E-03	3.558E+00
854	100	100	63.62	1.865E-07	-1.342E-03	3.558E+00
855	100	100	64.06	1.865E-07	-1.342E-03	3.558E+00
856	100	100	64.19	6.218E-08	-4.474E-04	1.186E+00
857	100	100	63.87	-6.218E-08	4.474E-04	-1.186E+00
858	100	97	63.38	-1.865E-07	1.342E-03	-3.558E+00
859	96	( <sup>o</sup> )	62.62	-1.865E-07	1.342E-03	-3.558E+00
860	94	( <sup>o</sup> )	61.32	-1.865E-07	1.342E-03	-3.558E+00
861	91	( <sup>o</sup> )	59.72	-1.865E-07	1.342E-03	-3.558E+00
862	88	( <sup>o</sup> )	58.3	-1.865E-07	1.342E-03	-3.558E+00
863	86	( <sup>o</sup> )	57.08	-1.865E-07	1.342E-03	-3.558E+00
864	84	( <sup>o</sup> )	55.85	-1.865E-07	1.342E-03	-3.558E+00
865	82	( <sup>o</sup> )	54.61	-1.865E-07	1.342E-03	-3.558E+00
866	79	( <sup>o</sup> )	53.36	-1.865E-07	1.342E-03	-3.558E+00
867	77	( <sup>o</sup> )	52.1	-1.865E-07	1.342E-03	-3.558E+00
868	75	( <sup>o</sup> )	50.74	-1.865E-07	1.342E-03	-3.558E+00
869	73	( <sup>o</sup> )	49.34	-1.865E-07	1.342E-03	-3.558E+00
870	72	( <sup>o</sup> )	48.05	-1.865E-07	1.342E-03	-3.558E+00
871	72	( <sup>o</sup> )	46.82	-1.865E-07	1.342E-03	-3.558E+00
872	72	( <sup>o</sup> )	45.61	-1.865E-07	1.342E-03	-3.558E+00
873	71	8	44.37	-1.865E-07	1.342E-03	-3.558E+00
874	68	9	43.06	-1.865E-07	1.342E-03	-3.558E+00
875	64	( <sup>o</sup> )	41.65	-1.865E-07	1.342E-03	-3.558E+00
876	58	( <sup>o</sup> )	40.32	-1.865E-07	1.342E-03	-3.558E+00
877	56	53	39.28	-1.865E-07	1.342E-03	-3.558E+00
878	56	67	38.4	-1.865E-07	1.342E-03	-3.558E+00
879	56	70	37.3	-1.865E-07	1.342E-03	-3.558E+00
880	56	67	35.79	-1.865E-07	1.342E-03	-3.558E+00
881	55	60	34.14	-1.865E-07	1.342E-03	-3.558E+00
882	54	60	32.69	-1.865E-07	1.342E-03	-3.558E+00
883	49	75	31.38	-1.865E-07	1.342E-03	-3.558E+00
884	38	80	29.63	-1.865E-07	1.342E-03	-3.558E+00
885	30	78	27.22	-1.865E-07	1.342E-03	-3.558E+00
886	25	53	25.01	-1.865E-07	1.342E-03	-3.558E+00
887	18	32	23.09	-1.865E-07	1.342E-03	-3.558E+00
888	14	16	20.23	-1.865E-07	1.342E-03	-3.558E+00
889	9	3	17.2	-1.865E-07	1.342E-03	-3.558E+00
890	5	( <sup>o</sup> )	12.61	-1.865E-07	1.342E-03	-3.558E+00
891	1	( <sup>o</sup> )	7.43	-1.865E-07	1.342E-03	-3.558E+00
892	0	0	2.81	-1.865E-07	1.342E-03	-3.558E+00
893	0	0	0	-1.865E-07	1.342E-03	-3.558E+00
900	0	0	0	-1.865E-07	1.342E-03	-3.558E+00
901	0	0	0	8.801E-06	-7.855E-03	-7.493E-01
902	0	0	0	1.779E-05	-1.705E-02	2.059E+00
903	0	0	0	2.678E-05	-2.625E-02	4.867E+00
919	0	0	0	2.678E-05	-2.625E-02	4.867E+00

920	4.5	47	2.63	2.678E-05	-2.625E-02	4.867E+00
921	12	85	4.93	2.678E-05	-2.625E-02	4.867E+00
922	30	97	7.24	2.678E-05	-2.625E-02	4.867E+00
923	42	100	9.73	2.678E-05	-2.625E-02	4.867E+00
924	51	100	11.91	2.678E-05	-2.625E-02	4.867E+00
925	54	100	14.16	2.678E-05	-2.625E-02	4.867E+00
926	54	97	16.04	2.678E-05	-2.625E-02	4.867E+00
927	52	90	17.98	2.678E-05	-2.625E-02	4.867E+00
928	48	75	20.21	2.678E-05	-2.625E-02	4.867E+00
929	44	57	22.03	2.678E-05	-2.625E-02	4.867E+00
930	37	47	22.35	8.925E-06	-8.749E-03	1.622E+00
931	29	40	21.52	-8.925E-06	8.749E-03	-1.622E+00
932	24	34	20.04	-2.678E-05	2.625E-02	-4.867E+00
933	21	27	18.29	-2.678E-05	2.625E-02	-4.867E+00
934	22	24	16.4	-2.678E-05	2.625E-02	-4.867E+00
935	22.5	22	14.4	-2.678E-05	2.625E-02	-4.867E+00
936	20	16	12.23	-2.678E-05	2.625E-02	-4.867E+00
937	15	7	9.84	-2.678E-05	2.625E-02	-4.867E+00
938	10	0	8.55	-2.678E-05	2.625E-02	-4.867E+00
939	5	(°)	7.56	-2.678E-05	2.625E-02	-4.867E+00
940	2	(°)	6.14	-2.678E-05	2.625E-02	-4.867E+00
941	1	(°)	2.6	-2.678E-05	2.625E-02	-4.867E+00
942	0	0	0	-2.678E-05	2.625E-02	-4.867E+00
943	0	0	0	-2.678E-05	2.625E-02	-4.867E+00
944	0	0	0	-1.658E-05	1.607E-02	-3.386E+00
945	1	0	1.06	-6.376E-06	5.889E-03	-1.905E+00
946	5	20	2.16	3.823E-06	-4.291E-03	-4.241E-01
947	15	43	3.3	3.823E-06	-4.291E-03	-4.241E-01
948	28	52	4.37	3.823E-06	-4.291E-03	-4.241E-01
949	34	64	5.42	3.823E-06	-4.291E-03	-4.241E-01
950	37	74	6.47	3.823E-06	-4.291E-03	-4.241E-01
951	37.5	90	7.51	3.823E-06	-4.291E-03	-4.241E-01
952	37	56	8.55	3.823E-06	-4.291E-03	-4.241E-01
953	36	27	9.55	3.823E-06	-4.291E-03	-4.241E-01
954	35	(°)	10.25	3.823E-06	-4.291E-03	-4.241E-01
955	33	(°)	10.78	3.823E-06	-4.291E-03	-4.241E-01
956	29	(°)	11.16	3.823E-06	-4.291E-03	-4.241E-01
957	29	(°)	11.76	3.823E-06	-4.291E-03	-4.241E-01
958	29	(°)	12.59	3.823E-06	-4.291E-03	-4.241E-01
959	34	30	13.8	3.823E-06	-4.291E-03	-4.241E-01
960	38	75	14.85	3.823E-06	-4.291E-03	-4.241E-01
961	34	70	15.59	3.823E-06	-4.291E-03	-4.241E-01
962	31	25	16.2	3.823E-06	-4.291E-03	-4.241E-01
963	28	(°)	16.82	3.823E-06	-4.291E-03	-4.241E-01
964	26	(°)	17.55	3.823E-06	-4.291E-03	-4.241E-01
965	24	(°)	17.91	3.823E-06	-4.291E-03	-4.241E-01
966	23	4	18.08	3.823E-06	-4.291E-03	-4.241E-01
967	23	22	18.1	3.823E-06	-4.291E-03	-4.241E-01
968	24	30	18.31	3.823E-06	-4.291E-03	-4.241E-01
969	23	32	18.67	3.823E-06	-4.291E-03	-4.241E-01
970	22	25	19.23	7.198E-06	-7.629E-03	2.015E+00
971	18	18	19.69	1.057E-05	-1.097E-02	4.453E+00
972	16	14	20.02	1.395E-05	-1.430E-02	6.892E+00
973	15	10	19.94	1.395E-05	-1.430E-02	6.892E+00
974	15	0	19.8	1.395E-05	-1.430E-02	6.892E+00
975	15	(°)	19.69	1.395E-05	-1.430E-02	6.892E+00
976	15	(°)	19.76	1.395E-05	-1.430E-02	6.892E+00
977	18	(°)	19.93	1.395E-05	-1.430E-02	6.892E+00
978	25	40	20.24	1.395E-05	-1.430E-02	6.892E+00
979	37	90	20.69	1.395E-05	-1.430E-02	6.892E+00
980	46	90	21.23	1.395E-05	-1.430E-02	6.892E+00
981	49	90	21.78	1.395E-05	-1.430E-02	6.892E+00
982	49	90	22.15	1.395E-05	-1.430E-02	6.892E+00
983	49	85	22.33	1.395E-05	-1.430E-02	6.892E+00
984	47	77	22.36	1.395E-05	-1.430E-02	6.892E+00
985	44	59	22.36	4.650E-06	-4.768E-03	2.297E+00
986	43	36	22.33	-4.650E-06	4.768E-03	-2.297E+00
987	42	13	22.15	-1.395E-05	1.430E-02	-6.892E+00
988	40	(°)	21.91	-1.395E-05	1.430E-02	-6.892E+00
989	41	65	21.62	-1.395E-05	1.430E-02	-6.892E+00
990	44	65	21.32	-1.395E-05	1.430E-02	-6.892E+00
991	45	65	21.01	-1.395E-05	1.430E-02	-6.892E+00

992	45	62	20.7	-1.395E-05	1.430E-02	-6.892E+00
993	44	56	20.48	-1.395E-05	1.430E-02	-6.892E+00
994	42	46	20.31	-1.395E-05	1.430E-02	-6.892E+00
995	41	36	20.13	-1.395E-05	1.430E-02	-6.892E+00
996	39	20	19.86	-1.395E-05	1.430E-02	-6.892E+00
997	38	4	19.49	-1.395E-05	1.430E-02	-6.892E+00
998	37	33	19.11	-1.395E-05	1.430E-02	-6.892E+00
999	38	39	18.71	-1.395E-05	1.430E-02	-6.892E+00
1,000	36	40	18.3	-1.395E-05	1.430E-02	-6.892E+00
1,001	35	40	17.86	-1.395E-05	1.430E-02	-6.892E+00
1,002	33	39	17.39	-1.395E-05	1.430E-02	-6.892E+00
1,003	30	36	16.86	-1.395E-05	1.430E-02	-6.892E+00
1,004	27	33	16.31	-1.395E-05	1.430E-02	-6.892E+00
1,005	22	24	15.75	-1.395E-05	1.430E-02	-6.892E+00
1,006	21	( <sup>e</sup> )	15.24	-1.395E-05	1.430E-02	-6.892E+00
1,007	20	( <sup>e</sup> )	14.73	-1.395E-05	1.430E-02	-6.892E+00
1,008	18	( <sup>e</sup> )	14.23	-1.395E-05	1.430E-02	-6.892E+00
1,009	17	28	13.73	-1.395E-05	1.430E-02	-6.892E+00
1,010	16	5	12.79	-1.395E-05	1.430E-02	-6.892E+00
1,011	14	( <sup>e</sup> )	11.11	-1.395E-05	1.430E-02	-6.892E+00
1,012	12	( <sup>e</sup> )	9.43	-1.395E-05	1.430E-02	-6.892E+00
1,013	9	( <sup>e</sup> )	7.75	-1.395E-05	1.430E-02	-6.892E+00
1,014	7	( <sup>e</sup> )	6.07	-1.395E-05	1.430E-02	-6.892E+00
1,015	5	( <sup>e</sup> )	4.39	-4.650E-06	4.768E-03	-2.297E+00
1,016	4	( <sup>e</sup> )	2.71	4.650E-06	-4.768E-03	2.297E+00
1,017	3	( <sup>e</sup> )	1.03	1.395E-05	-1.430E-02	6.892E+00
1,018	2	( <sup>e</sup> )	0.19	1.395E-05	-1.430E-02	6.892E+00
1,019	0	0	0	1.395E-05	-1.430E-02	6.892E+00
1,020	0	0	0	1.395E-05	-1.430E-02	6.892E+00
1,021	0	0	0	1.458E-05	-1.532E-02	5.630E+00
1,022	0	0	0	1.520E-05	-1.634E-02	4.368E+00
1,023	0	0	0	1.583E-05	-1.736E-02	3.105E+00
1,024	0	0	0	1.583E-05	-1.736E-02	3.105E+00
1,025	2	7	3.25	1.583E-05	-1.736E-02	3.105E+00
1,026	6	15	5.47	1.583E-05	-1.736E-02	3.105E+00
1,027	10	28	6.71	1.583E-05	-1.736E-02	3.105E+00
1,028	11	26	6.71	1.583E-05	-1.736E-02	3.105E+00
1,029	10	10	6.71	5.277E-06	-5.787E-03	1.035E+00
1,030	8	3	6.55	-5.277E-06	5.787E-03	-1.035E+00
1,031	5	0	6.01	-1.583E-05	1.736E-02	-3.105E+00
1,032	2	0	5.15	-1.583E-05	1.736E-02	-3.105E+00
1,033	0	0	3.9	-1.583E-05	1.736E-02	-3.105E+00
1,034	0	0	2.19	-1.583E-05	1.736E-02	-3.105E+00
1,035	0	0	0	-5.277E-06	5.787E-03	-1.035E+00
1,036	0	0	0	5.277E-06	-5.787E-03	1.035E+00
1,037	0	0	0	1.583E-05	-1.736E-02	3.105E+00
1,060	0	0	0	1.583E-05	-1.736E-02	3.105E+00
1,061	4	5	1.95	1.583E-05	-1.736E-02	3.105E+00
1,062	11	35	3.7	1.583E-05	-1.736E-02	3.105E+00
1,063	21	73	5.53	1.583E-05	-1.736E-02	3.105E+00
1,064	25	86	7.22	1.583E-05	-1.736E-02	3.105E+00
1,065	26	90	8.64	1.583E-05	-1.736E-02	3.105E+00
1,066	25	90	10.33	1.583E-05	-1.736E-02	3.105E+00
1,067	23	83	11.18	5.277E-06	-5.787E-03	1.035E+00
1,068	20	32	10.57	-5.277E-06	5.787E-03	-1.035E+00
1,069	16	( <sup>e</sup> )	9.33	-1.583E-05	1.736E-02	-3.105E+00
1,070	14	( <sup>e</sup> )	7.87	-1.583E-05	1.736E-02	-3.105E+00
1,071	10	( <sup>e</sup> )	6.27	-1.583E-05	1.736E-02	-3.105E+00
1,072	7	( <sup>e</sup> )	4.58	-1.583E-05	1.736E-02	-3.105E+00
1,073	3	( <sup>e</sup> )	3.81	-1.583E-05	1.736E-02	-3.105E+00
1,074	1	( <sup>e</sup> )	2.35	-1.583E-05	1.736E-02	-3.105E+00
1,075	0	0	0	-1.583E-05	1.736E-02	-3.105E+00
1,076	0	0	0	-6.540E-06	7.597E-03	-2.563E+00
1,077	0	0	0	2.749E-06	-2.167E-03	-2.021E+00
1,078	0	0	0	1.204E-05	-1.193E-02	-1.480E+00
1,097	0	0	0	1.204E-05	-1.193E-02	-1.480E+00
1,098	1	3	1.35	1.204E-05	-1.193E-02	-1.480E+00
1,099	3	6	3.37	1.204E-05	-1.193E-02	-1.480E+00
1,100	6	13	6.4	1.204E-05	-1.193E-02	-1.480E+00
1,101	9	14	8.47	1.204E-05	-1.193E-02	-1.480E+00
1,102	12	16	9.57	1.204E-05	-1.193E-02	-1.480E+00
1,103	15	28	10.19	1.204E-05	-1.193E-02	-1.480E+00

1,104	18	60	10.35	1.204E-05	-1.193E-02	-1.480E+00
1,105	20	47	10.46	1.204E-05	-1.193E-02	-1.480E+00
1,106	21	31	10.11	1.204E-05	-1.193E-02	-1.480E+00
1,107	21	15	9.12	1.204E-05	-1.193E-02	-1.480E+00
1,108	20	( <sup>a</sup> )	7.81	1.133E-05	-1.140E-02	1.667E-01
1,109	20	( <sup>a</sup> )	7.87	1.062E-05	-1.087E-02	1.813E+00
1,110	20	( <sup>a</sup> )	9.57	9.917E-06	-1.035E-02	3.459E+00
1,111	20	70	9.75	9.917E-06	-1.035E-02	3.459E+00
1,112	21	83	9.84	9.917E-06	-1.035E-02	3.459E+00
1,113	22	84	9.96	9.917E-06	-1.035E-02	3.459E+00
1,114	22	83	10.13	3.306E-06	-3.449E-03	1.153E+00
1,115	18	78	9.36	-3.306E-06	3.449E-03	-1.153E+00
1,116	14	68	8.8	-9.917E-06	1.035E-02	-3.459E+00
1,117	8	10	7.67	-9.917E-06	1.035E-02	-3.459E+00
1,118	4	4	6.08	-9.917E-06	1.035E-02	-3.459E+00
1,119	1	0	4.03	-9.917E-06	1.035E-02	-3.459E+00
1,120	0	0	0	-3.306E-06	3.449E-03	-1.153E+00
1,121	0	0	0	3.306E-06	-3.449E-03	1.153E+00
1,122	0	0	0	9.917E-06	-1.035E-02	3.459E+00
1,125	0	1	0	9.917E-06	-1.035E-02	3.459E+00
1,126	1	5	3.25	9.917E-06	-1.035E-02	3.459E+00
1,127	5	18	5.47	9.917E-06	-1.035E-02	3.459E+00
1,128	9	19	6.71	9.917E-06	-1.035E-02	3.459E+00
1,129	12	18	6.71	9.917E-06	-1.035E-02	3.459E+00
1,130	12	15	6.71	9.917E-06	-1.035E-02	3.459E+00
1,131	9	10	6.55	9.917E-06	-1.035E-02	3.459E+00
1,132	5	5	6.01	9.917E-06	-1.035E-02	3.459E+00
1,133	2	2	5.15	9.917E-06	-1.035E-02	3.459E+00
1,134	0	0	3.9	9.917E-06	-1.035E-02	3.459E+00
1,135	0	0	2.19	9.917E-06	-1.035E-02	3.459E+00
1,136	0	0	0	6.611E-06	-6.897E-03	2.306E+00
1,137	0	0	0	3.306E-06	-3.449E-03	1.153E+00
1,138	0	0	0	0	0	0
1,167	0	0	0	0	0	0

<sup>a</sup>Closed throttle motoring.

(c) The following transient test interval applies for compression-ignition engines and

powertrains when testing over the duty cycle specified in § 1036.512:

**Table 2 of Appendix B—Transient Test Interval for Compression-Ignition Engines and Powertrains Under § 1036.512**

Record (seconds)	Engine testing		Vehicle speed (mi/hr)	Powertrain testing		
	Normalized revolutions per minute (percent)	Normalized torque (percent)		Road grade coefficients		
				a	b	c
1	0	0	0	0	0	0
2	0	0	0	1.248E-05	-1.073E-02	1.064E+00
3	0	0	0	1.872E-05	-1.609E-02	1.596E+00
24	0	0	0	1.872E-05	-1.609E-02	1.596E+00
25	0	3.67	0	1.872E-05	-1.609E-02	1.596E+00
26	0	47.69	0	1.872E-05	-1.609E-02	1.596E+00
27	2.78	59.41	0.33	1.872E-05	-1.609E-02	1.596E+00
28	8.12	84.54	1.67	1.872E-05	-1.609E-02	1.596E+00
29	13.95	80	2.83	1.872E-05	-1.609E-02	1.596E+00
30	29.9	80	4.02	1.872E-05	-1.609E-02	1.596E+00
31	33.87	79.29	5.64	1.872E-05	-1.609E-02	1.596E+00
32	27.86	38.25	7.39	1.872E-05	-1.609E-02	1.596E+00
33	19.63	26.67	8.83	1.872E-05	-1.609E-02	1.596E+00
34	26.79	15.1	9.15	1.872E-05	-1.609E-02	1.596E+00
35	19.85	16.47	9.7	1.872E-05	-1.609E-02	1.596E+00
36	17.51	28.05	11.37	1.872E-05	-1.609E-02	1.596E+00
37	17.86	20.38	13.04	1.872E-05	-1.609E-02	1.596E+00
38	16.37	( <sup>a</sup> )	14.74	1.872E-05	-1.609E-02	1.596E+00
39	5.85	( <sup>a</sup> )	16.41	2.033E-05	-1.775E-02	3.890E+00
40	14.13	( <sup>a</sup> )	16.85	2.194E-05	-1.941E-02	6.184E+00
41	21.1	( <sup>a</sup> )	16.09	2.356E-05	-2.107E-02	8.477E+00
42	15.63	( <sup>a</sup> )	15.23	2.356E-05	-2.107E-02	8.477E+00
43	12.67	62.52	14.22	2.356E-05	-2.107E-02	8.477E+00
44	14.86	69.36	13.02	2.356E-05	-2.107E-02	8.477E+00
45	24.79	60	12.47	2.356E-05	-2.107E-02	8.477E+00
46	33.06	63.79	13.05	2.356E-05	-2.107E-02	8.477E+00
47	42.29	75.36	14.26	2.356E-05	-2.107E-02	8.477E+00
48	48.9	80	15.09	2.356E-05	-2.107E-02	8.477E+00
49	51.52	80	15.42	2.356E-05	-2.107E-02	8.477E+00
50	48.24	79.92	15.96	2.356E-05	-2.107E-02	8.477E+00
51	51.79	65.03	16.58	2.356E-05	-2.107E-02	8.477E+00
52	52.37	43.23	17.61	2.356E-05	-2.107E-02	8.477E+00
53	56.14	50	18.33	2.356E-05	-2.107E-02	8.477E+00
54	62.35	50	18.65	2.356E-05	-2.107E-02	8.477E+00
55	64.29	42.05	19.67	2.356E-05	-2.107E-02	8.477E+00
56	67.69	40	20.47	2.356E-05	-2.107E-02	8.477E+00
57	75.2	42.2	20.57	2.356E-05	-2.107E-02	8.477E+00
58	74.88	41.28	20.68	2.356E-05	-2.107E-02	8.477E+00
59	71.92	( <sup>a</sup> )	21.56	2.356E-05	-2.107E-02	8.477E+00
60	71.88	( <sup>a</sup> )	23.19	2.356E-05	-2.107E-02	8.477E+00
61	69.64	( <sup>a</sup> )	23.64	7.852E-06	-7.024E-03	2.826E+00
62	71.24	( <sup>a</sup> )	22.75	-7.852E-06	7.024E-03	-2.826E+00
63	71.72	30.54	21.81	-2.356E-05	2.107E-02	-8.477E+00
64	76.41	42.12	20.79	-2.356E-05	2.107E-02	-8.477E+00
65	73.02	50	19.86	-2.356E-05	2.107E-02	-8.477E+00
66	69.64	50	19.18	-2.356E-05	2.107E-02	-8.477E+00
67	72.09	43.16	18.75	-2.356E-05	2.107E-02	-8.477E+00
68	82.23	73.65	18.43	-2.356E-05	2.107E-02	-8.477E+00
69	78.58	( <sup>a</sup> )	18.61	-2.356E-05	2.107E-02	-8.477E+00
70	75	( <sup>a</sup> )	19.11	-2.356E-05	2.107E-02	-8.477E+00
71	75	( <sup>a</sup> )	18.76	-2.356E-05	2.107E-02	-8.477E+00
72	72.47	( <sup>a</sup> )	17.68	-2.356E-05	2.107E-02	-8.477E+00
73	62.91	( <sup>a</sup> )	16.46	-2.356E-05	2.107E-02	-8.477E+00
74	58.93	13.57	15.06	-2.356E-05	2.107E-02	-8.477E+00
75	55.56	29.43	13.41	-2.356E-05	2.107E-02	-8.477E+00
76	57.14	20	11.91	-2.356E-05	2.107E-02	-8.477E+00
77	56.68	17.42	11.09	-2.356E-05	2.107E-02	-8.477E+00
78	53.88	10	10.9	-2.356E-05	2.107E-02	-8.477E+00
79	50.76	10	11.4	-2.356E-05	2.107E-02	-8.477E+00

80	50	(°)	12.38	-2.356E-05	2.107E-02	-8.477E+00
81	46.83	(°)	13.02	-2.356E-05	2.107E-02	-8.477E+00
82	35.63	10	12.3	-2.356E-05	2.107E-02	-8.477E+00
83	32.48	10	10.32	-2.356E-05	2.107E-02	-8.477E+00
84	26.79	10	9.7	-2.356E-05	2.107E-02	-8.477E+00
85	24.94	10	11.05	-2.356E-05	2.107E-02	-8.477E+00
86	23.21	16.74	11.88	-2.356E-05	2.107E-02	-8.477E+00
87	24.7	3.36	12.21	-2.356E-05	2.107E-02	-8.477E+00
88	25	(°)	13.29	-2.356E-05	2.107E-02	-8.477E+00
89	24.47	(°)	13.73	-2.356E-05	2.107E-02	-8.477E+00
90	18.71	(°)	12.77	-2.356E-05	2.107E-02	-8.477E+00
91	10.85	(°)	11.46	-2.356E-05	2.107E-02	-8.477E+00
92	3.4	(°)	9.84	-2.356E-05	2.107E-02	-8.477E+00
93	0	0	7.62	-2.356E-05	2.107E-02	-8.477E+00
94	0	0	3.57	-2.356E-05	2.107E-02	-8.477E+00
95	0	0.91	1.33	-2.356E-05	2.107E-02	-8.477E+00
96	0	7.52	0	-2.356E-05	2.107E-02	-8.477E+00
97	0	0	0	-2.356E-05	2.107E-02	-8.477E+00
99	0	0	0	-2.356E-05	2.107E-02	-8.477E+00
100	0	0	0	-9.275E-06	8.450E-03	-4.643E+00
101	0	0	0	5.004E-06	-4.171E-03	-8.092E-01
102	0	0	0	1.928E-05	-1.679E-02	3.025E+00
128	0	0	0	1.928E-05	-1.679E-02	3.025E+00
129	1.58	(°)	0	1.928E-05	-1.679E-02	3.025E+00
130	1.43	(°)	0	1.928E-05	-1.679E-02	3.025E+00
131	0	0	0	1.928E-05	-1.679E-02	3.025E+00
132	0	0	0	1.928E-05	-1.679E-02	3.025E+00
133	1.91	9.28	0	1.928E-05	-1.679E-02	3.025E+00
134	2.75	0	0	1.928E-05	-1.679E-02	3.025E+00
135	0	0	0	1.928E-05	-1.679E-02	3.025E+00
146	0	0	0	1.928E-05	-1.679E-02	3.025E+00
147	0	5.51	0	1.928E-05	-1.679E-02	3.025E+00
148	0	11.34	0	1.928E-05	-1.679E-02	3.025E+00
149	0	0	0	1.928E-05	-1.679E-02	3.025E+00
157	0	0	0	1.928E-05	-1.679E-02	3.025E+00
158	0	0.21	0	1.928E-05	-1.679E-02	3.025E+00
159	0	30	0	1.928E-05	-1.679E-02	3.025E+00
160	0	26.78	0	1.928E-05	-1.679E-02	3.025E+00
161	0	20	0	1.928E-05	-1.679E-02	3.025E+00
162	0	20	0	1.928E-05	-1.679E-02	3.025E+00
163	0	4.12	0	1.928E-05	-1.679E-02	3.025E+00
164	0	0	0	1.928E-05	-1.679E-02	3.025E+00
183	0	0	0	1.928E-05	-1.679E-02	3.025E+00
184	0	20	0	1.928E-05	-1.679E-02	3.025E+00
185	0	20	0	1.928E-05	-1.679E-02	3.025E+00
186	0	11.73	0	1.928E-05	-1.679E-02	3.025E+00
187	0	0	0	1.928E-05	-1.679E-02	3.025E+00
213	0	0	0	1.928E-05	-1.679E-02	3.025E+00
214	0	73.41	0	1.928E-05	-1.679E-02	3.025E+00
215	0	90	0	1.928E-05	-1.679E-02	3.025E+00
216	27.95	81.3	0	1.928E-05	-1.679E-02	3.025E+00
217	36.74	90	2.8	1.928E-05	-1.679E-02	3.025E+00
218	39.29	90	5.59	1.928E-05	-1.679E-02	3.025E+00
219	41.44	90	8.39	1.928E-05	-1.679E-02	3.025E+00
220	45.57	82.41	11.19	1.928E-05	-1.679E-02	3.025E+00
221	59.52	80	14.3	1.928E-05	-1.679E-02	3.025E+00
222	66.99	90	16.03	1.928E-05	-1.679E-02	3.025E+00
223	80.22	90	17.3	1.928E-05	-1.679E-02	3.025E+00
224	86.41	93.88	19.72	1.928E-05	-1.679E-02	3.025E+00
225	86.53	50.94	23.18	1.928E-05	-1.679E-02	3.025E+00
226	84.46	17.02	25.27	1.928E-05	-1.679E-02	3.025E+00
227	88.54	28.6	26.91	1.928E-05	-1.679E-02	3.025E+00
228	89.29	39.83	28.89	1.928E-05	-1.679E-02	3.025E+00
229	89.29	30	29.43	1.928E-05	-1.679E-02	3.025E+00
230	89.29	26.69	29.5	1.928E-05	-1.679E-02	3.025E+00
231	90.16	20	30.49	1.928E-05	-1.679E-02	3.025E+00
232	89.92	20	32.02	1.928E-05	-1.679E-02	3.025E+00
233	89.29	36.06	32.91	1.928E-05	-1.679E-02	3.025E+00
234	85.86	40	32.55	1.928E-05	-1.679E-02	3.025E+00
235	85.51	30	32.26	1.928E-05	-1.679E-02	3.025E+00
236	84.42	32.75	32.65	1.928E-05	-1.679E-02	3.025E+00
237	86.48	35.68	33.5	1.928E-05	-1.679E-02	3.025E+00

238	88.55	30	34.96	1.928E-05	-1.679E-02	3.025E+00
239	89.29	44.93	36.44	1.928E-05	-1.679E-02	3.025E+00
240	90.9	50	36.95	6.428E-06	-5.597E-03	1.008E+00
241	77.27	(°)	37.02	-6.428E-06	5.597E-03	-1.008E+00
242	56.75	(°)	36.97	-1.928E-05	1.679E-02	-3.025E+00
243	50	(°)	36.37	-1.928E-05	1.679E-02	-3.025E+00
244	41.07	(°)	35.56	-1.928E-05	1.679E-02	-3.025E+00
245	37.38	45.18	34.72	-1.928E-05	1.679E-02	-3.025E+00
246	34.21	78.47	33.84	-1.928E-05	1.679E-02	-3.025E+00
247	32.13	80	33.4	-1.928E-05	1.679E-02	-3.025E+00
248	27.71	80	32.93	-1.928E-05	1.679E-02	-3.025E+00
249	22.64	80	31.98	-1.928E-05	1.679E-02	-3.025E+00
250	20.58	60.97	30.98	-1.928E-05	1.679E-02	-3.025E+00
251	16.25	27.34	29.91	-1.928E-05	1.679E-02	-3.025E+00
252	11.46	43.71	28.73	-1.928E-05	1.679E-02	-3.025E+00
253	9.02	68.95	27.34	-1.928E-05	1.679E-02	-3.025E+00
254	3.38	68.95	25.85	-1.928E-05	1.679E-02	-3.025E+00
255	1.32	44.28	24.49	-1.928E-05	1.679E-02	-3.025E+00
256	0	0	23.19	-1.928E-05	1.679E-02	-3.025E+00
257	0	0	21.87	-1.928E-05	1.679E-02	-3.025E+00
258	0	0	17.39	-1.928E-05	1.679E-02	-3.025E+00
259	0	0	12.92	-1.928E-05	1.679E-02	-3.025E+00
260	0	0	8.45	-1.928E-05	1.679E-02	-3.025E+00
261	0	0	3.97	-1.928E-05	1.679E-02	-3.025E+00
262	0	0	0	-1.928E-05	1.679E-02	-3.025E+00
263	0	24.97	0	-1.928E-05	1.679E-02	-3.025E+00
264	0	17.16	0	-1.928E-05	1.679E-02	-3.025E+00
265	0	6.2	0	-6.926E-06	5.240E-03	8.504E-01
266	0	10	0	5.431E-06	-6.313E-03	4.726E+00
267	0	10	0	1.779E-05	-1.787E-02	8.601E+00
268	0	0	0	1.779E-05	-1.787E-02	8.601E+00
320	0	0	0	1.779E-05	-1.787E-02	8.601E+00
321	0	15.55	0	1.779E-05	-1.787E-02	8.601E+00
322	0	20	0	1.779E-05	-1.787E-02	8.601E+00
323	21.59	19.08	1.2	1.779E-05	-1.787E-02	8.601E+00
324	20.54	10	2.18	1.779E-05	-1.787E-02	8.601E+00
325	10.32	1.86	2.88	1.779E-05	-1.787E-02	8.601E+00
326	6.13	(°)	3	1.779E-05	-1.787E-02	8.601E+00
327	5.36	(°)	2.28	1.779E-05	-1.787E-02	8.601E+00
328	0.64	(°)	0	1.779E-05	-1.787E-02	8.601E+00
329	0	0	0	1.779E-05	-1.787E-02	8.601E+00
374	0	0	0	1.779E-05	-1.787E-02	8.601E+00
375	0	0	0	2.077E-05	-1.947E-02	7.751E+00
376	0	0	0	2.376E-05	-2.108E-02	6.900E+00
377	0	29.59	0	2.674E-05	-2.269E-02	6.050E+00
378	-1.34	87.46	0	2.674E-05	-2.269E-02	6.050E+00
379	7.93	100	1.15	2.674E-05	-2.269E-02	6.050E+00
380	41.11	100	3.82	2.674E-05	-2.269E-02	6.050E+00
381	68.65	100	6.11	2.674E-05	-2.269E-02	6.050E+00
382	71.43	100	10	2.674E-05	-2.269E-02	6.050E+00
383	73.34	94.64	14.52	2.674E-05	-2.269E-02	6.050E+00
384	76.24	83.07	18.09	2.674E-05	-2.269E-02	6.050E+00
385	78.3	88.51	20.64	2.674E-05	-2.269E-02	6.050E+00
386	82.14	79.83	22.36	2.674E-05	-2.269E-02	6.050E+00
387	82.14	61.66	23.7	2.674E-05	-2.269E-02	6.050E+00
388	84.45	66.77	24.8	2.674E-05	-2.269E-02	6.050E+00
389	91.86	60	25.26	2.674E-05	-2.269E-02	6.050E+00
390	94.64	72.76	25.44	2.674E-05	-2.269E-02	6.050E+00
391	97.48	8.43	25.57	2.674E-05	-2.269E-02	6.050E+00
392	99.92	(°)	25.79	2.674E-05	-2.269E-02	6.050E+00
393	73.21	(°)	25.8	2.674E-05	-2.269E-02	6.050E+00
394	70.83	(°)	24.98	2.674E-05	-2.269E-02	6.050E+00
395	63.53	(°)	23.7	2.674E-05	-2.269E-02	6.050E+00
396	61.46	(°)	22.23	2.674E-05	-2.269E-02	6.050E+00
397	69.96	49.17	20.51	2.674E-05	-2.269E-02	6.050E+00
398	73.21	70	18.44	2.674E-05	-2.269E-02	6.050E+00
399	72.01	69.46	18.19	2.674E-05	-2.269E-02	6.050E+00
400	82.9	60	21.27	2.674E-05	-2.269E-02	6.050E+00
401	87.04	60	23.53	2.674E-05	-2.269E-02	6.050E+00
402	88.35	60	23.88	2.674E-05	-2.269E-02	6.050E+00
403	89.95	60	24.03	2.674E-05	-2.269E-02	6.050E+00
404	92.57	43.17	24.17	2.228E-05	-1.969E-02	5.457E+00



405	92.86	10.04	24.3	1.781E-05	-1.670E-02	4.864E+00
406	71.98	20	24.09	1.335E-05	-1.370E-02	4.271E+00
407	74.44	20	24.97	1.335E-05	-1.370E-02	4.271E+00
408	72.38	15.29	25.32	4.449E-06	-4.566E-03	1.424E+00
409	71.43	10	24.15	-4.449E-06	4.566E-03	-1.424E+00
410	68.63	(°)	23.14	-1.335E-05	1.370E-02	-4.271E+00
411	66.17	(°)	22.38	-1.335E-05	1.370E-02	-4.271E+00
412	63.93	(°)	21.58	-1.335E-05	1.370E-02	-4.271E+00
413	63.02	(°)	20.06	-1.335E-05	1.370E-02	-4.271E+00
414	69.64	(°)	18.29	-1.335E-05	1.370E-02	-4.271E+00
415	71.69	1.45	16.16	-1.335E-05	1.370E-02	-4.271E+00
416	71.91	17.3	13.44	-1.335E-05	1.370E-02	-4.271E+00
417	69.85	11.13	11	-1.335E-05	1.370E-02	-4.271E+00
418	70.04	19.55	10.13	-7.827E-06	7.759E-03	-3.711E+00
419	75.32	24.16	11.5	-2.306E-06	1.819E-03	-3.150E+00
420	64.43	80	13.65	3.214E-06	-4.121E-03	-2.590E+00
421	70.63	74.83	15.03	3.214E-06	-4.121E-03	-2.590E+00
422	80.44	16.04	17.5	3.214E-06	-4.121E-03	-2.590E+00
423	66.11	(°)	20.79	3.214E-06	-4.121E-03	-2.590E+00
424	60.73	(°)	22.92	3.214E-06	-4.121E-03	-2.590E+00
425	61.19	(°)	23.23	3.214E-06	-4.121E-03	-2.590E+00
426	53.03	(°)	22.42	3.214E-06	-4.121E-03	-2.590E+00
427	56.73	(°)	21.51	3.214E-06	-4.121E-03	-2.590E+00
428	62.5	2.38	20.46	3.214E-06	-4.121E-03	-2.590E+00
429	65.27	17.76	19.25	3.214E-06	-4.121E-03	-2.590E+00
430	64.4	(°)	19.61	3.214E-06	-4.121E-03	-2.590E+00
431	60.06	(°)	21.94	3.214E-06	-4.121E-03	-2.590E+00
432	32.17	(°)	22.99	3.214E-06	-4.121E-03	-2.590E+00
433	18.53	(°)	22.51	3.214E-06	-4.121E-03	-2.590E+00
434	10.26	(°)	21.98	3.214E-06	-4.121E-03	-2.590E+00
435	-1.87	0	21.39	3.214E-06	-4.121E-03	-2.590E+00
436	-0.65	0	20.73	3.214E-06	-4.121E-03	-2.590E+00
437	7.65	60	20.38	3.214E-06	-4.121E-03	-2.590E+00
438	27.28	61.93	20.38	3.214E-06	-4.121E-03	-2.590E+00
439	59.91	63	20.78	3.214E-06	-4.121E-03	-2.590E+00
440	76.81	39.85	21.84	3.214E-06	-4.121E-03	-2.590E+00
441	79.76	30	23.6	3.214E-06	-4.121E-03	-2.590E+00
442	81.82	30	25.31	3.214E-06	-4.121E-03	-2.590E+00
443	87.39	10.4	26.41	3.214E-06	-4.121E-03	-2.590E+00
444	87.26	1.37	27.29	3.214E-06	-4.121E-03	-2.590E+00
445	85.71	10	27.97	3.214E-06	-4.121E-03	-2.590E+00
446	85.71	0.96	28.2	3.214E-06	-4.121E-03	-2.590E+00
447	85.71	(°)	28.31	3.214E-06	-4.121E-03	-2.590E+00
448	76.13	28.34	29.22	3.214E-06	-4.121E-03	-2.590E+00
449	78.16	30.76	29.63	3.214E-06	-4.121E-03	-2.590E+00
450	76.93	29.18	29.64	3.214E-06	-4.121E-03	-2.590E+00
451	78.57	20	30.67	3.214E-06	-4.121E-03	-2.590E+00
452	77.87	20	32.17	3.214E-06	-4.121E-03	-2.590E+00
453	76.79	20	33.1	3.214E-06	-4.121E-03	-2.590E+00
454	78.05	20	33.3	3.214E-06	-4.121E-03	-2.590E+00
455	78.57	11.32	33.15	3.214E-06	-4.121E-03	-2.590E+00
456	69.5	(°)	32.66	3.214E-06	-4.121E-03	-2.590E+00
457	64.29	(°)	31.98	3.214E-06	-4.121E-03	-2.590E+00
458	63.68	(°)	31.48	3.214E-06	-4.121E-03	-2.590E+00
459	62.5	0.04	31.39	3.214E-06	-4.121E-03	-2.590E+00
460	62.5	(°)	31.3	3.214E-06	-4.121E-03	-2.590E+00
461	66.86	(°)	32.2	3.214E-06	-4.121E-03	-2.590E+00
462	66.13	(°)	33.13	3.214E-06	-4.121E-03	-2.590E+00
463	60.48	(°)	33.13	3.214E-06	-4.121E-03	-2.590E+00
464	58.93	(°)	33.14	3.214E-06	-4.121E-03	-2.590E+00
465	57.35	(°)	33.14	3.214E-06	-4.121E-03	-2.590E+00
466	55.36	(°)	33.15	3.214E-06	-4.121E-03	-2.590E+00
467	49.95	(°)	33.16	3.214E-06	-4.121E-03	-2.590E+00
468	48.21	(°)	33.16	3.214E-06	-4.121E-03	-2.590E+00
469	59.31	(°)	33.17	2.308E-06	-3.167E-03	-2.524E+00
470	67.15	70	33.3	1.401E-06	-2.214E-03	-2.458E+00
471	76.79	54.53	33.56	4.942E-07	-1.260E-03	-2.391E+00
472	76.79	24.56	35.59	4.942E-07	-1.260E-03	-2.391E+00
473	79.29	(°)	39.04	4.942E-07	-1.260E-03	-2.391E+00
474	80.36	(°)	41.83	4.942E-07	-1.260E-03	-2.391E+00
475	94.18	(°)	43.06	4.942E-07	-1.260E-03	-2.391E+00
476	66.07	(°)	43.13	4.942E-07	-1.260E-03	-2.391E+00

477	65.48	(°)	43.21	4.942E-07	-1.260E-03	-2.391E+00
478	63.41	10	43.29	4.942E-07	-1.260E-03	-2.391E+00
479	68.27	29.38	43.37	4.942E-07	-1.260E-03	-2.391E+00
480	72.87	40	44	4.942E-07	-1.260E-03	-2.391E+00
481	69.79	30.39	45.13	4.942E-07	-1.260E-03	-2.391E+00
482	66.19	26.46	47.02	4.942E-07	-1.260E-03	-2.391E+00
483	80.36	0	49.2	4.942E-07	-1.260E-03	-2.391E+00
484	81.13	0	49.92	4.942E-07	-1.260E-03	-2.391E+00
485	82.14	(°)	50.36	4.942E-07	-1.260E-03	-2.391E+00
486	83.48	(°)	51.52	4.942E-07	-1.260E-03	-2.391E+00
487	83.93	(°)	52.11	4.942E-07	-1.260E-03	-2.391E+00
488	84.04	(°)	52.12	4.942E-07	-1.260E-03	-2.391E+00
489	79.43	(°)	52.14	4.942E-07	-1.260E-03	-2.391E+00
490	56.47	(°)	52.16	4.942E-07	-1.260E-03	-2.391E+00
491	55.36	(°)	52.18	4.942E-07	-1.260E-03	-2.391E+00
492	44.23	45.37	52.2	4.942E-07	-1.260E-03	-2.391E+00
493	46.87	86.99	52.22	4.942E-07	-1.260E-03	-2.391E+00
494	57.14	90	52.16	4.942E-07	-1.260E-03	-2.391E+00
495	58.03	90	52.53	4.942E-07	-1.260E-03	-2.391E+00
496	64.22	93.22	52.98	4.942E-07	-1.260E-03	-2.391E+00
497	70.42	95.21	53.65	4.942E-07	-1.260E-03	-2.391E+00
498	73.21	83.64	54.77	4.942E-07	-1.260E-03	-2.391E+00
499	77.46	80	55.14	4.942E-07	-1.260E-03	-2.391E+00
500	83.67	80	54.57	4.942E-07	-1.260E-03	-2.391E+00
501	84.71	80	53.63	4.942E-07	-1.260E-03	-2.391E+00
502	92.5	80	52.7	4.942E-07	-1.260E-03	-2.391E+00
503	90.38	41.89	52.03	4.942E-07	-1.260E-03	-2.391E+00
504	85.25	24.85	51.66	4.942E-07	-1.260E-03	-2.391E+00
505	87.5	50	51.42	4.942E-07	-1.260E-03	-2.391E+00
506	89.1	50	51.28	4.942E-07	-1.260E-03	-2.391E+00
507	94.83	46.82	51.13	4.942E-07	-1.260E-03	-2.391E+00
508	98.96	(°)	51.53	4.942E-07	-1.260E-03	-2.391E+00
509	87.99	(°)	52.04	1.647E-07	-4.200E-04	-7.972E-01
510	63.35	(°)	51.32	-1.647E-07	4.200E-04	7.972E-01
511	60.06	(°)	49.2	-4.942E-07	1.260E-03	2.391E+00
512	54.43	(°)	46.43	-4.942E-07	1.260E-03	2.391E+00
513	42.88	(°)	43.58	-4.942E-07	1.260E-03	2.391E+00
514	46.71	(°)	40.65	-4.942E-07	1.260E-03	2.391E+00
515	48.21	(°)	37.62	-4.942E-07	1.260E-03	2.391E+00
516	58.28	(°)	34.62	-4.942E-07	1.260E-03	2.391E+00
517	69.64	(°)	31.62	-4.942E-07	1.260E-03	2.391E+00
518	51.44	(°)	28.44	-4.942E-07	1.260E-03	2.391E+00
519	38.02	(°)	25.01	-4.942E-07	1.260E-03	2.391E+00
520	34.65	(°)	21.38	-4.942E-07	1.260E-03	2.391E+00
521	19.97	(°)	17.39	-4.942E-07	1.260E-03	2.391E+00
522	3.14	(°)	12.76	-4.942E-07	1.260E-03	2.391E+00
523	0	0	6.14	-4.942E-07	1.260E-03	2.391E+00
524	-1.3	36.39	0	-4.942E-07	1.260E-03	2.391E+00
525	-0.21	5.75	0	-4.942E-07	1.260E-03	2.391E+00
526	0	0	0	-4.942E-07	1.260E-03	2.391E+00
527	0	0	0	-4.942E-07	1.260E-03	2.391E+00
528	0	0	0	-4.942E-07	1.260E-03	2.391E+00
529	0	0	0	-4.942E-07	1.260E-03	2.391E+00
530	0	0	0	7.439E-06	-5.768E-03	1.455E+00
531	0	0	0	1.537E-05	-1.280E-02	5.195E-01
532	0	0	0	2.331E-05	-1.982E-02	-4.165E-01
543	0	0	0	2.331E-05	-1.982E-02	-4.165E-01
544	0	(°)	0	2.331E-05	-1.982E-02	-4.165E-01
545	0	0	0	2.331E-05	-1.982E-02	-4.165E-01
546	-0.67	0	0	2.331E-05	-1.982E-02	-4.165E-01
547	-0.5	0	0	2.331E-05	-1.982E-02	-4.165E-01
548	3.57	(°)	0	2.331E-05	-1.982E-02	-4.165E-01
549	0.61	(°)	0	2.331E-05	-1.982E-02	-4.165E-01
550	0	0	0	2.331E-05	-1.982E-02	-4.165E-01
551	0	0	0	2.331E-05	-1.982E-02	-4.165E-01
552	0	2.6	0	2.331E-05	-1.982E-02	-4.165E-01
553	0	20	0	2.331E-05	-1.982E-02	-4.165E-01
554	0	20	0	2.331E-05	-1.982E-02	-4.165E-01
555	0	7.96	0	2.331E-05	-1.982E-02	-4.165E-01
556	0	0	0	2.331E-05	-1.982E-02	-4.165E-01
557	0	0	0	2.331E-05	-1.982E-02	-4.165E-01
558	0	78.53	0	2.331E-05	-1.982E-02	-4.165E-01

559	1.65	60	0	2.331E-05	-1.982E-02	-4.165E-01
560	9.91	63.88	2.8	2.331E-05	-1.982E-02	-4.165E-01
561	14.29	70	6.02	2.331E-05	-1.982E-02	-4.165E-01
562	26.83	70	8.57	2.331E-05	-1.982E-02	-4.165E-01
563	38.29	70	11.07	2.331E-05	-1.982E-02	-4.165E-01
564	50.09	70	13.68	2.331E-05	-1.982E-02	-4.165E-01
565	56.6	66.52	16.52	2.331E-05	-1.982E-02	-4.165E-01
566	63.09	59.94	19.38	2.331E-05	-1.982E-02	-4.165E-01
567	65.16	80	21.91	2.331E-05	-1.982E-02	-4.165E-01
568	69.53	86.46	24.34	2.331E-05	-1.982E-02	-4.165E-01
569	78.6	90	27.02	2.331E-05	-1.982E-02	-4.165E-01
570	80.36	90	29.41	2.331E-05	-1.982E-02	-4.165E-01
571	82.35	100	31.57	2.331E-05	-1.982E-02	-4.165E-01
572	83.93	100	33.52	2.331E-05	-1.982E-02	-4.165E-01
573	84.7	100	35.75	2.331E-05	-1.982E-02	-4.165E-01
574	85.71	100	38.34	2.331E-05	-1.982E-02	-4.165E-01
575	87.04	100	40.83	2.331E-05	-1.982E-02	-4.165E-01
576	97.18	100	43.37	2.331E-05	-1.982E-02	-4.165E-01
577	98.21	83.92	44.9	2.331E-05	-1.982E-02	-4.165E-01
578	93.54	(°)	45.32	7.769E-06	-6.608E-03	-1.388E-01
579	78.13	(°)	45.25	-7.769E-06	6.608E-03	1.388E-01
580	80.36	0	44.24	-2.331E-05	1.982E-02	4.165E-01
581	81.59	(°)	42.61	-2.331E-05	1.982E-02	4.165E-01
582	73.07	(°)	40.93	-2.331E-05	1.982E-02	4.165E-01
583	58.92	(°)	39.03	-2.331E-05	1.982E-02	4.165E-01
584	56.86	(°)	36.96	-2.331E-05	1.982E-02	4.165E-01
585	54.22	(°)	34.84	-2.331E-05	1.982E-02	4.165E-01
586	50.94	(°)	32.66	-2.331E-05	1.982E-02	4.165E-01
587	47.74	(°)	30.4	-2.331E-05	1.982E-02	4.165E-01
588	45.02	(°)	28.04	-2.331E-05	1.982E-02	4.165E-01
589	39.56	(°)	25.57	-2.331E-05	1.982E-02	4.165E-01
590	33.55	37.91	22.94	-2.331E-05	1.982E-02	4.165E-01
591	29.89	20	20.11	-2.331E-05	1.982E-02	4.165E-01
592	27.82	20	18.17	-2.331E-05	1.982E-02	4.165E-01
593	25.76	20	17.2	-2.331E-05	1.982E-02	4.165E-01
594	19.76	20	16.06	-2.331E-05	1.982E-02	4.165E-01
595	8.31	(°)	14.93	-2.331E-05	1.982E-02	4.165E-01
596	0	0	13.78	-2.331E-05	1.982E-02	4.165E-01
597	0	0	10.72	-2.331E-05	1.982E-02	4.165E-01
598	0	0	6.24	-2.331E-05	1.982E-02	4.165E-01
599	0	0	1.77	-2.331E-05	1.982E-02	4.165E-01
600	0	0	0	-2.331E-05	1.982E-02	4.165E-01
605	0	0	0	-2.331E-05	1.982E-02	4.165E-01
606	2.25	6.3	0	-2.331E-05	1.982E-02	4.165E-01
607	9.2	17.87	0	-1.029E-05	8.762E-03	1.296E+00
608	12.4	20	0.75	2.727E-06	-2.302E-03	2.176E+00
609	18.04	20	1.9	1.574E-05	-1.337E-02	3.055E+00
610	21.49	22.59	3.81	1.574E-05	-1.337E-02	3.055E+00
611	29.76	17.5	5.91	1.574E-05	-1.337E-02	3.055E+00
612	35.98	(°)	7.92	1.574E-05	-1.337E-02	3.055E+00
613	42.72	(°)	9.86	1.574E-05	-1.337E-02	3.055E+00
614	58.93	7.78	9.37	1.574E-05	-1.337E-02	3.055E+00
615	60.71	10.93	5.32	1.574E-05	-1.337E-02	3.055E+00
616	60.35	32.04	1.45	1.574E-05	-1.337E-02	3.055E+00
617	58.93	40	4.28	1.574E-05	-1.337E-02	3.055E+00
618	59.86	40	6.78	1.574E-05	-1.337E-02	3.055E+00
619	60.71	40	9.12	1.574E-05	-1.337E-02	3.055E+00
620	60.71	48.33	11.69	1.574E-05	-1.337E-02	3.055E+00
621	67.79	99.53	14.17	1.574E-05	-1.337E-02	3.055E+00
622	69.64	100	16.35	1.574E-05	-1.337E-02	3.055E+00
623	69.64	100	19.18	1.574E-05	-1.337E-02	3.055E+00
624	68.81	100	22.35	1.574E-05	-1.337E-02	3.055E+00
625	67.86	100	25.17	1.574E-05	-1.337E-02	3.055E+00
626	67.86	100	27.6	1.574E-05	-1.337E-02	3.055E+00
627	67.86	100	29.72	1.574E-05	-1.337E-02	3.055E+00
628	67.53	100	31.71	1.574E-05	-1.337E-02	3.055E+00
629	65.18	97.5	33.6	1.574E-05	-1.337E-02	3.055E+00
630	68.58	90	35.39	1.574E-05	-1.337E-02	3.055E+00
631	71.66	90	37.08	1.574E-05	-1.337E-02	3.055E+00
632	74.5	90	38.83	1.574E-05	-1.337E-02	3.055E+00
633	75	98.79	40.28	1.574E-05	-1.337E-02	3.055E+00
634	75	100	41.29	1.574E-05	-1.337E-02	3.055E+00

635	74.65	100	42.31	1.574E-05	-1.337E-02	3.055E+00
636	73.21	100	42.9	1.574E-05	-1.337E-02	3.055E+00
637	74.13	94.91	42.94	1.574E-05	-1.337E-02	3.055E+00
638	77.38	90	42.83	1.574E-05	-1.337E-02	3.055E+00
639	80.04	90	42.74	1.574E-05	-1.337E-02	3.055E+00
640	80.36	99.81	42.65	1.574E-05	-1.337E-02	3.055E+00
641	79.87	100	42.56	1.574E-05	-1.337E-02	3.055E+00
642	76.79	100	42.88	1.574E-05	-1.337E-02	3.055E+00
643	76.79	95.47	43.29	1.574E-05	-1.337E-02	3.055E+00
644	77.88	90	43.3	1.574E-05	-1.337E-02	3.055E+00
645	78.57	90	43.37	1.574E-05	-1.337E-02	3.055E+00
646	78.57	80.74	43.79	1.574E-05	-1.337E-02	3.055E+00
647	78.57	79.17	44.07	1.574E-05	-1.337E-02	3.055E+00
648	78.57	77.21	44.01	1.574E-05	-1.337E-02	3.055E+00
649	78.57	100	44.41	1.046E-05	-8.994E-03	2.433E+00
650	78.57	94.45	44.85	5.183E-06	-4.623E-03	1.811E+00
651	78.57	90	44.83	-9.733E-08	-2.513E-04	1.190E+00
652	78.57	90	44.78	-9.733E-08	-2.513E-04	1.190E+00
653	80.36	90	45	-9.733E-08	-2.513E-04	1.190E+00
654	80.03	90	45.8	-9.733E-08	-2.513E-04	1.190E+00
655	79.18	90	46.46	-9.733E-08	-2.513E-04	1.190E+00
656	80.36	90	46.54	-9.733E-08	-2.513E-04	1.190E+00
657	80.36	90	46.12	-9.733E-08	-2.513E-04	1.190E+00
658	81.81	81.86	45.94	-9.733E-08	-2.513E-04	1.190E+00
659	82.14	80	45.81	-9.733E-08	-2.513E-04	1.190E+00
660	80.36	81.29	45.45	-9.733E-08	-2.513E-04	1.190E+00
661	79.85	92.86	45.81	-9.733E-08	-2.513E-04	1.190E+00
662	77.78	100	46.26	-9.733E-08	-2.513E-04	1.190E+00
663	76.79	100	46.32	-9.733E-08	-2.513E-04	1.190E+00
664	76.79	100	46.28	-9.733E-08	-2.513E-04	1.190E+00
665	80.05	100	46.46	-9.733E-08	-2.513E-04	1.190E+00
666	80.36	99.27	46.92	-9.733E-08	-2.513E-04	1.190E+00
667	80.77	90	47.16	-9.733E-08	-2.513E-04	1.190E+00
668	82.84	90	47.58	-9.733E-08	-2.513E-04	1.190E+00
669	84.9	90	48.04	-9.733E-08	-2.513E-04	1.190E+00
670	89.48	82.97	48.05	-9.733E-08	-2.513E-04	1.190E+00
671	91.07	80	48.02	-9.733E-08	-2.513E-04	1.190E+00
672	91.07	70.18	48	-9.733E-08	-2.513E-04	1.190E+00
673	91.07	80	47.97	-9.733E-08	-2.513E-04	1.190E+00
674	86.91	50.07	47.95	-9.733E-08	-2.513E-04	1.190E+00
675	77.7	(°)	47.95	-9.733E-08	-2.513E-04	1.190E+00
676	76.79	(°)	48.86	-9.733E-08	-2.513E-04	1.190E+00
677	65.29	22.19	49.92	-9.733E-08	-2.513E-04	1.190E+00
678	67.65	39.62	50.26	-9.733E-08	-2.513E-04	1.190E+00
679	67.64	48.8	50.18	-9.733E-08	-2.513E-04	1.190E+00
680	67.06	37.23	49.91	-9.733E-08	-2.513E-04	1.190E+00
681	69.64	34.34	49.9	-9.733E-08	-2.513E-04	1.190E+00
682	71.76	40	49.88	-9.733E-08	-2.513E-04	1.190E+00
683	69.21	47.49	49.87	-9.733E-08	-2.513E-04	1.190E+00
684	72.71	50	49.86	-9.733E-08	-2.513E-04	1.190E+00
685	73.33	39.36	49.85	-9.733E-08	-2.513E-04	1.190E+00
686	75	27.79	49.83	-9.733E-08	-2.513E-04	1.190E+00
687	75	16.21	49.82	-9.733E-08	-2.513E-04	1.190E+00
688	75	15.36	49.67	-9.733E-08	-2.513E-04	1.190E+00
689	76.24	26.93	49.6	-9.733E-08	-2.513E-04	1.190E+00
690	76.79	30	50.23	-9.733E-08	-2.513E-04	1.190E+00
691	76.79	30.08	50.78	-9.733E-08	-2.513E-04	1.190E+00
692	76.49	40	50.77	-9.733E-08	-2.513E-04	1.190E+00
693	75.58	40	50.76	-9.733E-08	-2.513E-04	1.190E+00
694	76.79	35.2	50.64	-9.733E-08	-2.513E-04	1.190E+00
695	77.93	30	50.14	-9.733E-08	-2.513E-04	1.190E+00
696	78.57	22.05	49.74	-9.733E-08	-2.513E-04	1.190E+00
697	76.87	(°)	50.07	-9.733E-08	-2.513E-04	1.190E+00
698	74.8	(°)	50.56	-9.733E-08	-2.513E-04	1.190E+00
699	72.74	(°)	50.73	-2.744E-06	1.973E-03	3.071E-01
700	72.95	(°)	50.76	-5.391E-06	4.198E-03	-5.755E-01
701	76.04	(°)	50.79	-8.038E-06	6.423E-03	-1.458E+00
702	75.46	(°)	50.82	-8.038E-06	6.423E-03	-1.458E+00
703	73.4	(°)	50.85	-8.038E-06	6.423E-03	-1.458E+00
704	71.33	(°)	50.88	-8.038E-06	6.423E-03	-1.458E+00
705	69.27	(°)	50.91	-8.038E-06	6.423E-03	-1.458E+00
706	67.86	6.31	50.94	-8.038E-06	6.423E-03	-1.458E+00

707	70.68	0	50.98	-8.038E-06	6.423E-03	-1.458E+00
708	67.11	27.36	51	-8.038E-06	6.423E-03	-1.458E+00
709	64.29	40	51.03	-8.038E-06	6.423E-03	-1.458E+00
710	64.29	40	51.04	-8.038E-06	6.423E-03	-1.458E+00
711	66.07	38.44	51.05	-8.038E-06	6.423E-03	-1.458E+00
712	66.07	30	51.19	-8.038E-06	6.423E-03	-1.458E+00
713	66.07	30	51.69	-8.038E-06	6.423E-03	-1.458E+00
714	66.07	36.28	52.35	-8.038E-06	6.423E-03	-1.458E+00
715	64.67	47.86	52.85	-8.038E-06	6.423E-03	-1.458E+00
716	60.92	59.43	53.06	-8.038E-06	6.423E-03	-1.458E+00
717	65.89	50	53.07	-8.038E-06	6.423E-03	-1.458E+00
718	64.75	50	53.06	-8.038E-06	6.423E-03	-1.458E+00
719	66.07	45.85	53.06	-8.038E-06	6.423E-03	-1.458E+00
720	65.04	57.18	53.05	-8.038E-06	6.423E-03	-1.458E+00
721	68.2	62.7	53.05	-8.038E-06	6.423E-03	-1.458E+00
722	72.81	60	53.05	-8.038E-06	6.423E-03	-1.458E+00
723	71.59	60	53.04	-8.038E-06	6.423E-03	-1.458E+00
724	74.64	60	53.03	-6.308E-06	4.994E-03	-7.637E-01
725	74.5	56.4	53.02	-4.577E-06	3.565E-03	-6.931E-02
726	76.79	50	53.24	-2.847E-06	2.136E-03	6.251E-01
727	77.99	50	53.73	-2.847E-06	2.136E-03	6.251E-01
728	77.09	50	53.98	-2.847E-06	2.136E-03	6.251E-01
729	76.79	40.11	53.98	-2.847E-06	2.136E-03	6.251E-01
730	78.83	61.47	53.98	-2.847E-06	2.136E-03	6.251E-01
731	79.27	63.92	53.98	-2.847E-06	2.136E-03	6.251E-01
732	77.61	50	53.97	-2.847E-06	2.136E-03	6.251E-01
733	77.46	50	53.95	-2.847E-06	2.136E-03	6.251E-01
734	78.17	42.24	53.95	-2.847E-06	2.136E-03	6.251E-01
735	78.57	49.34	53.94	-2.847E-06	2.136E-03	6.251E-01
736	76.79	50.91	53.94	-2.847E-06	2.136E-03	6.251E-01
737	76.79	67.45	53.94	-2.847E-06	2.136E-03	6.251E-01
738	76.79	81.88	54.15	-2.847E-06	2.136E-03	6.251E-01
739	77.79	70	54.65	-2.847E-06	2.136E-03	6.251E-01
740	79.86	77.21	54.92	-2.847E-06	2.136E-03	6.251E-01
741	81.93	88.78	54.9	-2.847E-06	2.136E-03	6.251E-01
742	80.42	89.65	54.89	-2.847E-06	2.136E-03	6.251E-01
743	82.14	80	54.97	-2.847E-06	2.136E-03	6.251E-01
744	82.77	80	55.44	-2.847E-06	2.136E-03	6.251E-01
745	83.93	80	55.82	-2.847E-06	2.136E-03	6.251E-01
746	83.93	80	55.8	-2.847E-06	2.136E-03	6.251E-01
747	83.93	80	55.79	-2.847E-06	2.136E-03	6.251E-01
748	83.93	80	55.78	-2.847E-06	2.136E-03	6.251E-01
749	83.93	81.37	55.76	-5.174E-06	4.059E-03	-2.026E-01
750	84.46	87.05	55.75	-7.501E-06	5.983E-03	-1.030E+00
751	85.71	57.4	55.74	-9.827E-06	7.906E-03	-1.858E+00
752	85.71	42.19	55.42	-9.827E-06	7.906E-03	-1.858E+00
753	85.71	42.33	54.91	-9.827E-06	7.906E-03	-1.858E+00
754	85.71	40	55.19	-9.827E-06	7.906E-03	-1.858E+00
755	85.71	38.37	55.64	-9.827E-06	7.906E-03	-1.858E+00
756	85.71	12.83	55.31	-9.827E-06	7.906E-03	-1.858E+00
757	85.71	(°)	55.36	-9.827E-06	7.906E-03	-1.858E+00
758	85.71	(°)	55.75	-9.827E-06	7.906E-03	-1.858E+00
759	85.71	(°)	55.78	-9.827E-06	7.906E-03	-1.858E+00
760	87.27	7.37	55.81	-9.827E-06	7.906E-03	-1.858E+00
761	89.33	19.74	55.85	-9.827E-06	7.906E-03	-1.858E+00
762	91.07	11.83	55.86	-9.827E-06	7.906E-03	-1.858E+00
763	91.07	26.81	55.84	-9.827E-06	7.906E-03	-1.858E+00
764	91.96	49.96	55.81	-9.827E-06	7.906E-03	-1.858E+00
765	92.86	60	55.78	-9.827E-06	7.906E-03	-1.858E+00
766	91.4	60	55.74	-9.827E-06	7.906E-03	-1.858E+00
767	92.8	60	56.19	-9.827E-06	7.906E-03	-1.858E+00
768	92.86	40	57.13	-9.827E-06	7.906E-03	-1.858E+00
769	92.86	25.75	57.59	-9.827E-06	7.906E-03	-1.858E+00
770	92.07	(°)	57.55	-9.827E-06	7.906E-03	-1.858E+00
771	90	(°)	57.52	-9.827E-06	7.906E-03	-1.858E+00
772	89.29	(°)	57.53	-9.827E-06	7.906E-03	-1.858E+00
773	90.92	44.88	57.58	-9.827E-06	7.906E-03	-1.858E+00
774	91.07	36.4	57.63	-1.014E-05	8.189E-03	-1.873E+00
775	91.07	(°)	57.64	-1.045E-05	8.472E-03	-1.887E+00
776	91.07	(°)	58.11	-1.077E-05	8.756E-03	-1.902E+00
777	90.1	(°)	58.52	-1.077E-05	8.756E-03	-1.902E+00
778	90.54	(°)	58.38	-1.077E-05	8.756E-03	-1.902E+00

779	89.54	(°)	58.24	-1.077E-05	8.756E-03	-1.902E+00
780	87.47	(°)	58.1	-1.077E-05	8.756E-03	-1.902E+00
781	85.71	(°)	57.96	-1.077E-05	8.756E-03	-1.902E+00
782	85.71	10	57.81	-1.077E-05	8.756E-03	-1.902E+00
783	85.71	0.23	57.67	-1.077E-05	8.756E-03	-1.902E+00
784	85.71	(°)	57.66	-1.077E-05	8.756E-03	-1.902E+00
785	85.71	(°)	57.89	-1.077E-05	8.756E-03	-1.902E+00
786	84	(°)	58.03	-1.077E-05	8.756E-03	-1.902E+00
787	69.64	(°)	57.99	-1.077E-05	8.756E-03	-1.902E+00
788	69.15	(°)	57.96	-1.077E-05	8.756E-03	-1.902E+00
789	63.99	28.96	57.93	-1.077E-05	8.756E-03	-1.902E+00
790	59.98	80	57.89	-1.077E-05	8.756E-03	-1.902E+00
791	59.38	87.48	57.85	-1.077E-05	8.756E-03	-1.902E+00
792	63.78	90	57.8	-1.077E-05	8.756E-03	-1.902E+00
793	66.19	90	57.72	-1.077E-05	8.756E-03	-1.902E+00
794	67.46	92.2	57.65	-1.077E-05	8.756E-03	-1.902E+00
795	66.74	100	57.57	-1.077E-05	8.756E-03	-1.902E+00
796	68.81	94.65	57.5	-1.077E-05	8.756E-03	-1.902E+00
797	70.88	83.08	57.8	-1.077E-05	8.756E-03	-1.902E+00
798	71.43	71.51	58.72	-1.077E-05	8.756E-03	-1.902E+00
799	71.44	69.93	59.25	-8.819E-06	7.137E-03	-1.079E+00
800	73.51	58.36	59.19	-6.873E-06	5.518E-03	-2.559E-01
801	75	50	59.16	-4.927E-06	3.899E-03	5.670E-01
802	75	59.58	59.15	-4.927E-06	3.899E-03	5.670E-01
803	75	76.36	59.15	-4.927E-06	3.899E-03	5.670E-01
804	75	80	59.14	-4.927E-06	3.899E-03	5.670E-01
805	75	70.49	59.14	-4.927E-06	3.899E-03	5.670E-01
806	73.21	80	59.62	-4.927E-06	3.899E-03	5.670E-01
807	72.74	82.66	59.93	-4.927E-06	3.899E-03	5.670E-01
808	71.43	90	59.42	-4.927E-06	3.899E-03	5.670E-01
809	69.36	90	59.07	-4.927E-06	3.899E-03	5.670E-01
810	66.54	75.24	59.05	-4.927E-06	3.899E-03	5.670E-01
811	69.27	78.96	59.03	-4.927E-06	3.899E-03	5.670E-01
812	73.12	80	59.02	-4.927E-06	3.899E-03	5.670E-01
813	71.8	80	59	-4.927E-06	3.899E-03	5.670E-01
814	73.21	83.68	58.99	-4.927E-06	3.899E-03	5.670E-01
815	74.15	79.5	58.97	-4.927E-06	3.899E-03	5.670E-01
816	75	70	58.96	-4.927E-06	3.899E-03	5.670E-01
817	75	61.6	58.95	-4.927E-06	3.899E-03	5.670E-01
818	75	50.03	58.94	-4.927E-06	3.899E-03	5.670E-01
819	76.79	60	58.93	-4.927E-06	3.899E-03	5.670E-01
820	76.79	60	58.93	-4.927E-06	3.899E-03	5.670E-01
821	76.79	69.39	59.38	-4.927E-06	3.899E-03	5.670E-01
822	79.03	73.73	59.87	-4.927E-06	3.899E-03	5.670E-01
823	78.96	70	59.91	-4.927E-06	3.899E-03	5.670E-01
824	78.57	70	59.9	-4.927E-06	3.899E-03	5.670E-01
825	83.93	70.99	59.89	-4.927E-06	3.899E-03	5.670E-01
826	84.38	80	59.88	-4.927E-06	3.899E-03	5.670E-01
827	84.97	80	59.88	-4.927E-06	3.899E-03	5.670E-01
828	84.95	80	59.87	-4.927E-06	3.899E-03	5.670E-01
829	84.41	80	59.86	-5.382E-06	4.139E-03	6.372E-01
830	83.93	80	59.85	-5.838E-06	4.378E-03	7.074E-01
831	83.93	77.89	59.84	-6.294E-06	4.618E-03	7.776E-01
832	83.93	31.99	60.25	-6.294E-06	4.618E-03	7.776E-01
833	83.93	43.57	60.73	-6.294E-06	4.618E-03	7.776E-01
834	83.93	60.28	60.8	-6.294E-06	4.618E-03	7.776E-01
835	83.93	63.29	60.81	-6.294E-06	4.618E-03	7.776E-01
836	83.93	76.57	60.81	-6.294E-06	4.618E-03	7.776E-01
837	83.93	89.86	60.81	-6.294E-06	4.618E-03	7.776E-01
838	84.19	90	60.8	-6.294E-06	4.618E-03	7.776E-01
839	87.32	87	60.79	-6.294E-06	4.618E-03	7.776E-01
840	91.88	80	60.78	-6.294E-06	4.618E-03	7.776E-01
841	92.86	73.85	60.77	-6.294E-06	4.618E-03	7.776E-01
842	92.86	62.28	60.34	-6.294E-06	4.618E-03	7.776E-01
843	92.86	69.29	59.34	-6.294E-06	4.618E-03	7.776E-01
844	94.64	70	58.76	-6.294E-06	4.618E-03	7.776E-01
845	94.64	62.7	58.76	-6.294E-06	4.618E-03	7.776E-01
846	94.64	40	58.75	-6.294E-06	4.618E-03	7.776E-01
847	93.64	40	58.75	-6.294E-06	4.618E-03	7.776E-01
848	92.86	32.85	58.57	-6.294E-06	4.618E-03	7.776E-01
849	92.86	30	58.08	-7.448E-06	5.557E-03	8.947E-02
850	92.86	0.3	57.77	-8.602E-06	6.495E-03	-5.987E-01

851	92.53	11.87	57.78	-9.756E-06	7.434E-03	-1.287E+00
852	89.84	13.12	57.8	-9.756E-06	7.434E-03	-1.287E+00
853	87.5	5.01	57.82	-9.756E-06	7.434E-03	-1.287E+00
854	86.32	10	57.84	-9.756E-06	7.434E-03	-1.287E+00
855	85.71	(°)	57.86	-9.756E-06	7.434E-03	-1.287E+00
856	85.71	(°)	57.88	-9.756E-06	7.434E-03	-1.287E+00
857	85.71	(°)	57.99	-9.756E-06	7.434E-03	-1.287E+00
858	85.21	(°)	58.19	-9.756E-06	7.434E-03	-1.287E+00
859	83.93	(°)	58.39	-9.756E-06	7.434E-03	-1.287E+00
860	83.93	(°)	58.59	-9.756E-06	7.434E-03	-1.287E+00
861	85.29	5.18	58.79	-9.756E-06	7.434E-03	-1.287E+00
862	87.35	(°)	59	-9.756E-06	7.434E-03	-1.287E+00
863	87.5	(°)	57.32	-9.756E-06	7.434E-03	-1.287E+00
864	87.5	(°)	58.15	-9.756E-06	7.434E-03	-1.287E+00
865	86.8	(°)	58.57	-9.756E-06	7.434E-03	-1.287E+00
866	85.71	6.35	58.99	-9.756E-06	7.434E-03	-1.287E+00
867	85.71	12.98	59.41	-3.252E-06	2.478E-03	-4.290E-01
868	85.71	10	59.38	3.252E-06	-2.478E-03	4.290E-01
869	85.65	10	58.9	9.756E-06	-7.434E-03	1.287E+00
870	82.14	10	58.42	9.756E-06	-7.434E-03	1.287E+00
871	82.14	10	57.46	9.756E-06	-7.434E-03	1.287E+00
872	83.02	14.89	55.85	9.756E-06	-7.434E-03	1.287E+00
873	83.93	13.54	54.38	9.756E-06	-7.434E-03	1.287E+00
874	81.06	42.12	53.19	9.756E-06	-7.434E-03	1.287E+00
875	78.64	40.4	52	9.756E-06	-7.434E-03	1.287E+00
876	76.99	30	50.8	9.756E-06	-7.434E-03	1.287E+00
877	78.57	32.75	49.59	9.756E-06	-7.434E-03	1.287E+00
878	77.8	44.32	48.39	9.756E-06	-7.434E-03	1.287E+00
879	75.73	50	47.07	9.756E-06	-7.434E-03	1.287E+00
880	73.67	50	45.71	9.756E-06	-7.434E-03	1.287E+00
881	73.21	50	44.46	9.756E-06	-7.434E-03	1.287E+00
882	73.32	40	43.27	9.756E-06	-7.434E-03	1.287E+00
883	74.22	35.64	42.1	9.756E-06	-7.434E-03	1.287E+00
884	71.43	20	40.89	9.756E-06	-7.434E-03	1.287E+00
885	75.23	51.95	39.61	9.756E-06	-7.434E-03	1.287E+00
886	77.34	66.21	38.22	9.756E-06	-7.434E-03	1.287E+00
887	75.28	60	36.96	9.756E-06	-7.434E-03	1.287E+00
888	73.21	9.96	36.06	9.756E-06	-7.434E-03	1.287E+00
889	70.85	1.61	35.23	9.756E-06	-7.434E-03	1.287E+00
890	67.29	19.56	34.02	9.756E-06	-7.434E-03	1.287E+00
891	65.22	40	32.37	9.756E-06	-7.434E-03	1.287E+00
892	63.15	8.35	30.81	9.756E-06	-7.434E-03	1.287E+00
893	61.09	(°)	29.57	9.756E-06	-7.434E-03	1.287E+00
894	42.1	8.95	28.26	9.756E-06	-7.434E-03	1.287E+00
895	31.96	10	25.94	9.756E-06	-7.434E-03	1.287E+00
896	29.42	7.38	23.56	9.756E-06	-7.434E-03	1.287E+00
897	26.04	(°)	22	9.756E-06	-7.434E-03	1.287E+00
898	14.71	(°)	19.21	9.756E-06	-7.434E-03	1.287E+00
899	1.9	(°)	16.51	9.756E-06	-7.434E-03	1.287E+00
900	0	0	12.12	9.756E-06	-7.434E-03	1.287E+00
901	0	0	7.07	9.756E-06	-7.434E-03	1.287E+00
902	0	0	2.6	9.756E-06	-7.434E-03	1.287E+00
903	0	0	0	9.756E-06	-7.434E-03	1.287E+00
904	0	0	0	1.390E-05	-1.206E-02	3.180E+00
905	0	0	0	1.805E-05	-1.669E-02	5.073E+00
906	0	0	0	2.219E-05	-2.131E-02	6.967E+00
926	0	0	0	2.219E-05	-2.131E-02	6.967E+00
927	0	3.67	0	2.219E-05	-2.131E-02	6.967E+00
928	0	47.69	0	2.219E-05	-2.131E-02	6.967E+00
929	2.78	59.41	0.33	2.219E-05	-2.131E-02	6.967E+00
930	8.12	84.54	1.67	2.219E-05	-2.131E-02	6.967E+00
931	13.95	80	2.83	2.219E-05	-2.131E-02	6.967E+00
932	29.9	80	4.02	2.219E-05	-2.131E-02	6.967E+00
933	33.87	79.29	5.64	2.219E-05	-2.131E-02	6.967E+00
934	27.86	38.25	7.39	2.219E-05	-2.131E-02	6.967E+00
935	19.63	26.67	8.83	2.219E-05	-2.131E-02	6.967E+00
936	26.79	15.1	9.15	2.219E-05	-2.131E-02	6.967E+00
937	19.85	16.47	9.7	2.219E-05	-2.131E-02	6.967E+00
938	17.51	28.05	11.37	2.219E-05	-2.131E-02	6.967E+00
939	17.86	20.38	13.04	2.219E-05	-2.131E-02	6.967E+00
940	16.37	(°)	14.74	2.219E-05	-2.131E-02	6.967E+00
941	5.85	(°)	16.41	2.219E-05	-2.131E-02	6.967E+00

942	14.13	(°)	16.85	2.219E-05	-2.131E-02	6.967E+00
943	21.1	(°)	16.09	2.219E-05	-2.131E-02	6.967E+00
944	15.63	(°)	15.23	2.219E-05	-2.131E-02	6.967E+00
945	12.67	62.52	14.22	2.219E-05	-2.131E-02	6.967E+00
946	14.86	69.36	13.02	2.219E-05	-2.131E-02	6.967E+00
947	24.79	60	12.47	2.219E-05	-2.131E-02	6.967E+00
948	33.06	63.79	13.05	2.219E-05	-2.131E-02	6.967E+00
949	42.29	75.36	14.26	2.219E-05	-2.131E-02	6.967E+00
950	48.9	80	15.09	2.219E-05	-2.131E-02	6.967E+00
951	51.52	80	15.42	2.219E-05	-2.131E-02	6.967E+00
952	48.24	79.92	15.96	2.219E-05	-2.131E-02	6.967E+00
953	51.79	65.03	16.58	2.219E-05	-2.131E-02	6.967E+00
954	52.37	43.23	17.61	2.219E-05	-2.131E-02	6.967E+00
955	56.14	50	18.33	2.219E-05	-2.131E-02	6.967E+00
956	62.35	50	18.65	2.219E-05	-2.131E-02	6.967E+00
957	64.29	42.05	19.67	2.219E-05	-2.131E-02	6.967E+00
958	67.69	40	20.47	2.219E-05	-2.131E-02	6.967E+00
959	75.2	42.2	20.57	2.219E-05	-2.131E-02	6.967E+00
960	74.88	41.28	20.68	2.219E-05	-2.131E-02	6.967E+00
961	71.92	(°)	21.56	2.219E-05	-2.131E-02	6.967E+00
962	71.88	(°)	23.19	2.219E-05	-2.131E-02	6.967E+00
963	69.64	(°)	23.64	7.398E-06	-7.105E-03	2.322E+00
964	71.24	(°)	22.75	-7.398E-06	7.105E-03	-2.322E+00
965	71.72	30.54	21.81	-2.219E-05	2.131E-02	-6.967E+00
966	76.41	42.12	20.79	-2.219E-05	2.131E-02	-6.967E+00
967	73.02	50	19.86	-2.219E-05	2.131E-02	-6.967E+00
968	69.64	50	19.18	-2.219E-05	2.131E-02	-6.967E+00
969	72.09	43.16	18.75	-2.219E-05	2.131E-02	-6.967E+00
970	82.23	73.65	18.43	-2.219E-05	2.131E-02	-6.967E+00
971	78.58	(°)	18.61	-2.219E-05	2.131E-02	-6.967E+00
972	75	(°)	19.11	-2.219E-05	2.131E-02	-6.967E+00
973	75	(°)	18.76	-2.219E-05	2.131E-02	-6.967E+00
974	72.47	(°)	17.68	-2.219E-05	2.131E-02	-6.967E+00
975	62.91	(°)	16.46	-2.219E-05	2.131E-02	-6.967E+00
976	58.93	13.57	15.06	-2.219E-05	2.131E-02	-6.967E+00
977	55.56	29.43	13.41	-2.219E-05	2.131E-02	-6.967E+00
978	57.14	20	11.91	-2.219E-05	2.131E-02	-6.967E+00
979	56.68	17.42	11.09	-2.219E-05	2.131E-02	-6.967E+00
980	53.88	10	10.9	-2.219E-05	2.131E-02	-6.967E+00
981	50.76	10	11.4	-2.219E-05	2.131E-02	-6.967E+00
982	50	(°)	12.38	-2.219E-05	2.131E-02	-6.967E+00
983	46.83	(°)	13.02	-2.219E-05	2.131E-02	-6.967E+00
984	35.63	10	12.3	-2.219E-05	2.131E-02	-6.967E+00
985	32.48	10	10.32	-2.219E-05	2.131E-02	-6.967E+00
986	26.79	10	9.7	-2.219E-05	2.131E-02	-6.967E+00
987	24.94	10	11.05	-2.219E-05	2.131E-02	-6.967E+00
988	23.21	16.74	11.88	-2.219E-05	2.131E-02	-6.967E+00
989	24.7	3.36	12.21	-2.219E-05	2.131E-02	-6.967E+00
990	25	(°)	13.29	-2.219E-05	2.131E-02	-6.967E+00
991	24.47	(°)	13.73	-2.219E-05	2.131E-02	-6.967E+00
992	18.71	(°)	12.77	-2.219E-05	2.131E-02	-6.967E+00
993	10.85	(°)	11.46	-2.219E-05	2.131E-02	-6.967E+00
994	3.4	(°)	9.84	-2.219E-05	2.131E-02	-6.967E+00
995	0	0	7.62	-2.219E-05	2.131E-02	-6.967E+00
996	0	0	3.57	-2.219E-05	2.131E-02	-6.967E+00
997	0	0.91	1.33	-2.219E-05	2.131E-02	-6.967E+00
998	0	7.52	0	-2.219E-05	2.131E-02	-6.967E+00
999	0	0	0	-2.219E-05	2.131E-02	-6.967E+00
1,000	0	0	0	-4.577E-06	5.686E-03	-3.784E+00
1,001	0	0	0	1.304E-05	-9.944E-03	-6.018E-01
1,002	0	0	0	3.066E-05	-2.557E-02	2.581E+00
1,030	0	0	0	3.066E-05	-2.557E-02	2.581E+00
1,031	1.58	(°)	0	3.066E-05	-2.557E-02	2.581E+00
1,032	1.43	(°)	0	3.066E-05	-2.557E-02	2.581E+00
1,033	0	0	0	3.066E-05	-2.557E-02	2.581E+00
1,034	0	0	0	3.066E-05	-2.557E-02	2.581E+00
1,035	1.91	9.28	0	3.066E-05	-2.557E-02	2.581E+00
1,036	2.75	0	0	3.066E-05	-2.557E-02	2.581E+00
1,037	0	0	0	3.066E-05	-2.557E-02	2.581E+00
1,048	0	0	0	3.066E-05	-2.557E-02	2.581E+00
1,049	0	5.51	0	3.066E-05	-2.557E-02	2.581E+00
1,050	0	11.34	0	3.066E-05	-2.557E-02	2.581E+00



1,051	0	0	0	3.066E-05	-2.557E-02	2.581E+00
1,059	0	0	0	3.066E-05	-2.557E-02	2.581E+00
1,060	0	0.21	0	3.066E-05	-2.557E-02	2.581E+00
1,061	0	30	0	3.066E-05	-2.557E-02	2.581E+00
1,062	0	26.78	0	3.066E-05	-2.557E-02	2.581E+00
1,063	0	20	0	3.066E-05	-2.557E-02	2.581E+00
1,064	0	20	0	3.066E-05	-2.557E-02	2.581E+00
1,065	0	4.12	0	3.066E-05	-2.557E-02	2.581E+00
1,066	0	0	0	3.066E-05	-2.557E-02	2.581E+00
1,085	0	0	0	3.066E-05	-2.557E-02	2.581E+00
1,086	0	20	0	3.066E-05	-2.557E-02	2.581E+00
1,087	0	20	0	3.066E-05	-2.557E-02	2.581E+00
1,088	0	11.73	0	3.066E-05	-2.557E-02	2.581E+00
1,089	0	0	0	3.066E-05	-2.557E-02	2.581E+00
1,115	0	0	0	3.066E-05	-2.557E-02	2.581E+00
1,116	0	73.41	0	3.066E-05	-2.557E-02	2.581E+00
1,117	0	90	0	3.066E-05	-2.557E-02	2.581E+00
1,118	27.95	81.3	2.83	3.066E-05	-2.557E-02	2.581E+00
1,119	36.74	90	5.87	3.066E-05	-2.557E-02	2.581E+00
1,120	39.29	90	8.67	3.066E-05	-2.557E-02	2.581E+00
1,121	41.44	90	11.47	3.066E-05	-2.557E-02	2.581E+00
1,122	45.57	82.41	14.26	3.066E-05	-2.557E-02	2.581E+00
1,123	59.52	80	16.91	3.066E-05	-2.557E-02	2.581E+00
1,124	66.99	90	18.33	3.066E-05	-2.557E-02	2.581E+00
1,125	80.22	90	19.35	3.066E-05	-2.557E-02	2.581E+00
1,126	86.41	93.88	21.55	3.066E-05	-2.557E-02	2.581E+00
1,127	86.53	50.94	24.84	3.066E-05	-2.557E-02	2.581E+00
1,128	84.46	17.02	26.81	3.066E-05	-2.557E-02	2.581E+00
1,129	88.54	28.6	28.36	2.397E-05	-2.025E-02	2.539E+00
1,130	89.29	39.83	30.31	1.729E-05	-1.494E-02	2.498E+00
1,131	89.29	30	30.82	1.060E-05	-9.616E-03	2.457E+00
1,132	89.29	26.69	30.86	1.060E-05	-9.616E-03	2.457E+00
1,133	90.16	20	31.82	1.060E-05	-9.616E-03	2.457E+00
1,134	89.92	20	33.33	1.060E-05	-9.616E-03	2.457E+00
1,135	89.29	36.06	34.2	1.060E-05	-9.616E-03	2.457E+00
1,136	85.86	40	33.82	1.060E-05	-9.616E-03	2.457E+00
1,137	85.51	30	33.51	1.060E-05	-9.616E-03	2.457E+00
1,138	84.42	32.75	33.87	1.060E-05	-9.616E-03	2.457E+00
1,139	86.48	35.68	34.7	1.060E-05	-9.616E-03	2.457E+00
1,140	88.55	30	36.14	1.060E-05	-9.616E-03	2.457E+00
1,141	89.29	44.93	37.6	1.060E-05	-9.616E-03	2.457E+00
1,142	90.9	50	38.09	1.060E-05	-9.616E-03	2.457E+00
1,143	77.27	( <sup>c</sup> )	38.13	3.535E-06	-3.205E-03	8.188E-01
1,144	56.75	( <sup>c</sup> )	38.05	-3.535E-06	3.205E-03	-8.188E-01
1,145	50	( <sup>c</sup> )	37.47	-1.060E-05	9.616E-03	-2.457E+00
1,146	41.07	( <sup>c</sup> )	36.69	-1.060E-05	9.616E-03	-2.457E+00
1,147	37.38	45.18	35.89	-1.060E-05	9.616E-03	-2.457E+00
1,148	34.21	78.47	35.06	-1.060E-05	9.616E-03	-2.457E+00
1,149	32.13	80	34.63	-1.060E-05	9.616E-03	-2.457E+00
1,150	27.71	80	34.13	-1.060E-05	9.616E-03	-2.457E+00
1,151	22.64	80	33.15	-1.060E-05	9.616E-03	-2.457E+00
1,152	20.58	60.97	32.12	-1.060E-05	9.616E-03	-2.457E+00
1,153	16.25	27.34	31.02	-1.060E-05	9.616E-03	-2.457E+00
1,154	11.46	43.71	29.82	-1.060E-05	9.616E-03	-2.457E+00
1,155	9.02	68.95	28.41	-1.060E-05	9.616E-03	-2.457E+00
1,156	3.38	68.95	26.91	-1.060E-05	9.616E-03	-2.457E+00
1,157	1.32	44.28	25.53	-1.060E-05	9.616E-03	-2.457E+00
1,158	0	0	24.21	-1.060E-05	9.616E-03	-2.457E+00
1,159	0	0	22.88	-1.060E-05	9.616E-03	-2.457E+00
1,160	0	0	18.4	-1.060E-05	9.616E-03	-2.457E+00
1,161	0	0	13.93	-1.060E-05	9.616E-03	-2.457E+00
1,162	0	0	9.45	-1.060E-05	9.616E-03	-2.457E+00
1,163	0	0	4.98	-1.060E-05	9.616E-03	-2.457E+00
1,164	0	0	0.5	-7.069E-06	6.411E-03	-1.638E+00
1,165	0	24.97	0	-3.535E-06	3.205E-03	-8.188E-01
1,166	0	17.16	0	0	0	0
1,167	0	6.2	0	0	0	0
1,168	0	10	0	0	0	0
1,169	0	10	0	0	0	0
1,170	0	0	0	0	0	0
1,199	0	0	0	0	0	0

<sup>a</sup>Closed throttle motoring.

(d) The following transient duty cycle applies for compression-ignition engines and powertrains when testing under § 1036.514:

**Table 3 of Appendix B—Transient Duty Cycle for Compression-Ignition Engines and Powertrains Under § 1036.514**

Record (seconds)	Engine testing		Vehicle speed (mi/hr)	Powertrain testing		
	Normalized revolutions per minute (percent)	Normalized torque (percent)		Road grade coefficients		
				<i>a</i>	<i>b</i>	<i>c</i>
1	0	0	0	0	0	0
2	0	0	0	-4.441E-06	-1.101E-03	-8.083E-02
3	0	0	0	-6.661E-06	-1.651E-03	-1.213E-01
69	0	0	0	-6.661E-06	-1.651E-03	-1.213E-01
70	3	5	0	-6.661E-06	-1.651E-03	-1.213E-01
71	7	10	0	-6.661E-06	-1.651E-03	-1.213E-01
72	15.1	16.5	2.81	-6.661E-06	-1.651E-03	-1.213E-01
73	28.3	10.4	3.37	-6.661E-06	-1.651E-03	-1.213E-01
74	46	11.1	4.13	-6.661E-06	-1.651E-03	-1.213E-01
75	66.5	12.3	5.01	-6.661E-06	-1.651E-03	-1.213E-01
76	37.6	1	4.76	-6.661E-06	-1.651E-03	-1.213E-01
77	54.6	20.7	5.82	-6.661E-06	-1.651E-03	-1.213E-01
78	76.6	15.9	7.07	-6.661E-06	-1.651E-03	-1.213E-01
79	47.9	2	6.8	-6.661E-06	-1.651E-03	-1.213E-01
80	64.7	36.4	8.13	-6.661E-06	-1.651E-03	-1.213E-01
81	77.4	29.6	9.59	-6.661E-06	-1.651E-03	-1.213E-01
82	28.2	2.9	9.11	-6.661E-06	-1.651E-03	-1.213E-01
83	48.4	54.9	11.38	-6.661E-06	-1.651E-03	-1.213E-01
84	72.1	17.7	14.2	-6.661E-06	-1.651E-03	-1.213E-01
85	82.5	10.7	15.43	-6.661E-06	-1.651E-03	-1.213E-01
86	60.2	1.1	16.12	-6.661E-06	-1.651E-03	-1.213E-01
87	64.4	( <sup>a</sup> )	16.88	-6.661E-06	-1.651E-03	-1.213E-01
88	67.8	( <sup>a</sup> )	17.38	-6.661E-06	-1.651E-03	-1.213E-01
89	62.7	12	17.72	-6.661E-06	-1.651E-03	-1.213E-01
90	47	28.9	18.17	-6.661E-06	-1.651E-03	-1.213E-01
91	52.3	( <sup>a</sup> )	19.23	-6.661E-06	-1.651E-03	-1.213E-01
92	54.5	( <sup>a</sup> )	19.66	-6.661E-06	-1.651E-03	-1.213E-01
93	54.7	( <sup>a</sup> )	19.7	-6.661E-06	-1.651E-03	-1.213E-01
94	53.6	( <sup>a</sup> )	19.49	-6.661E-06	-1.651E-03	-1.213E-01
95	50.4	( <sup>a</sup> )	18.89	-6.661E-06	-1.651E-03	-1.213E-01
96	46	( <sup>a</sup> )	18.06	-6.661E-06	-1.651E-03	-1.213E-01
97	44.1	( <sup>a</sup> )	17.69	-6.661E-06	-1.651E-03	-1.213E-01
98	42.5	( <sup>a</sup> )	17.39	-6.661E-06	-1.651E-03	-1.213E-01
99	42.4	( <sup>a</sup> )	17.38	-6.661E-06	-1.651E-03	-1.213E-01
100	43	( <sup>a</sup> )	17.5	-6.661E-06	-1.651E-03	-1.213E-01
101	42.5	( <sup>a</sup> )	17.39	-6.661E-06	-1.651E-03	-1.213E-01
102	41.4	( <sup>a</sup> )	17.18	-6.661E-06	-1.651E-03	-1.213E-01
103	41.6	( <sup>a</sup> )	17.21	-6.661E-06	-1.651E-03	-1.213E-01
104	42.1	( <sup>a</sup> )	17.31	-2.220E-06	-5.503E-04	-4.042E-02
105	41.4	( <sup>a</sup> )	17.18	2.220E-06	5.503E-04	4.042E-02
106	40.6	( <sup>a</sup> )	17.06	6.661E-06	1.651E-03	1.213E-01
107	38.2	( <sup>a</sup> )	16.57	6.661E-06	1.651E-03	1.213E-01
108	35.4	0.8	16.04	6.661E-06	1.651E-03	1.213E-01
109	34	2.8	15.78	6.661E-06	1.651E-03	1.213E-01
110	33	4.5	15.59	6.661E-06	1.651E-03	1.213E-01
111	32.3	5.3	15.45	6.661E-06	1.651E-03	1.213E-01
112	31.5	0	15.31	6.661E-06	1.651E-03	1.213E-01
113	28.9	( <sup>a</sup> )	14.85	6.661E-06	1.651E-03	1.213E-01
114	28.8	( <sup>a</sup> )	14.84	6.661E-06	1.651E-03	1.213E-01
115	24.9	( <sup>a</sup> )	14.1	6.661E-06	1.651E-03	1.213E-01
116	19.1	( <sup>a</sup> )	13.06	6.661E-06	1.651E-03	1.213E-01
117	29.8	( <sup>a</sup> )	11.8	6.661E-06	1.651E-03	1.213E-01
118	20.6	( <sup>a</sup> )	10.43	6.661E-06	1.651E-03	1.213E-01
119	14.7	( <sup>a</sup> )	9.55	6.661E-06	1.651E-03	1.213E-01
120	19.7	16.8	9.1	6.661E-06	1.651E-03	1.213E-01
121	21.8	( <sup>a</sup> )	8.39	6.661E-06	1.651E-03	1.213E-01
122	15.2	( <sup>a</sup> )	7.62	6.661E-06	1.651E-03	1.213E-01
123	24.8	10.6	6.59	6.661E-06	1.651E-03	1.213E-01
124	20.5	9.5	5.05	6.661E-06	1.651E-03	1.213E-01
125	19.7	15.6	4.15	6.661E-06	1.651E-03	1.213E-01
126	8.5	( <sup>a</sup> )	3.29	6.661E-06	1.651E-03	1.213E-01

127	0	0	2.77	6.661E-06	1.651E-03	1.213E-01
128	0.5	5.4	2.69	6.661E-06	1.651E-03	1.213E-01
129	0	0	2.45	6.661E-06	1.651E-03	1.213E-01
130	0.5	5.7	2.08	6.661E-06	1.651E-03	1.213E-01
131	1.7	9.8	1.69	6.661E-06	1.651E-03	1.213E-01
132	6.7	14.6	1.64	2.220E-06	5.503E-04	4.042E-02
133	6.5	12	1.83	-2.220E-06	-5.503E-04	-4.042E-02
134	6.5	9.8	2.02	-6.661E-06	-1.651E-03	-1.213E-01
135	6.6	8.6	2.14	-6.661E-06	-1.651E-03	-1.213E-01
136	6	8.1	2.21	-6.661E-06	-1.651E-03	-1.213E-01
137	4.5	7.3	2.21	-6.661E-06	-1.651E-03	-1.213E-01
138	3.4	8.2	2.22	-6.661E-06	-1.651E-03	-1.213E-01
139	8	17	2.44	-6.661E-06	-1.651E-03	-1.213E-01
140	17.4	8	2.91	-6.661E-06	-1.651E-03	-1.213E-01
141	28.3	6.2	3.38	-6.661E-06	-1.651E-03	-1.213E-01
142	35.4	9.6	3.68	-6.661E-06	-1.651E-03	-1.213E-01
143	51	9.7	4.35	-6.661E-06	-1.651E-03	-1.213E-01
144	62	10.6	4.82	-6.661E-06	-1.651E-03	-1.213E-01
145	32.4	1	4.49	-6.661E-06	-1.651E-03	-1.213E-01
146	58.1	24.4	6.01	-6.661E-06	-1.651E-03	-1.213E-01
147	89.1	27.9	7.71	-6.661E-06	-1.651E-03	-1.213E-01
148	32.4	3	7.32	-6.661E-06	-1.651E-03	-1.213E-01
149	38.6	17.1	8.08	-6.661E-06	-1.651E-03	-1.213E-01
150	48.9	19.8	9.02	-6.661E-06	-1.651E-03	-1.213E-01
151	61.4	18.7	10.16	-6.661E-06	-1.651E-03	-1.213E-01
152	70.7	14.8	11.03	-6.661E-06	-1.651E-03	-1.213E-01
153	45.7	0.8	10.91	-6.661E-06	-1.651E-03	-1.213E-01
154	49	20.7	11.51	-6.661E-06	-1.651E-03	-1.213E-01
155	57.5	23.4	12.49	-6.661E-06	-1.651E-03	-1.213E-01
156	66.7	22.1	13.56	-6.661E-06	-1.651E-03	-1.213E-01
157	48.7	5.8	13.8	-6.661E-06	-1.651E-03	-1.213E-01
158	44.5	14.3	13.91	-6.661E-06	-1.651E-03	-1.213E-01
159	45	6.9	14	-6.661E-06	-1.651E-03	-1.213E-01
160	44.3	1.5	13.91	-6.661E-06	-1.651E-03	-1.213E-01
161	46.4	19.2	14.19	-6.661E-06	-1.651E-03	-1.213E-01
162	48.3	6.9	14.48	-2.220E-06	-5.503E-04	-4.042E-02
163	48.2	5.8	14.47	2.220E-06	5.503E-04	4.042E-02
164	47.6	5.8	14.38	6.661E-06	1.651E-03	1.213E-01
165	46.6	4	14.24	6.661E-06	1.651E-03	1.213E-01
166	45.1	3.6	14.02	6.661E-06	1.651E-03	1.213E-01
167	44	2.9	13.86	6.661E-06	1.651E-03	1.213E-01
168	42.4	3.4	13.63	6.661E-06	1.651E-03	1.213E-01
169	41.7	1	13.52	6.661E-06	1.651E-03	1.213E-01
170	37.9	(°)	12.97	6.661E-06	1.651E-03	1.213E-01
171	32.7	(°)	12.22	6.661E-06	1.651E-03	1.213E-01
172	20.8	(°)	10.49	6.661E-06	1.651E-03	1.213E-01
173	18.8	13.7	8	6.661E-06	1.651E-03	1.213E-01
174	16.3	3.5	5.87	6.661E-06	1.651E-03	1.213E-01
175	14.1	5.3	4.27	6.661E-06	1.651E-03	1.213E-01
176	6.7	1.3	2.95	6.661E-06	1.651E-03	1.213E-01
177	0.1	5.9	1.76	6.661E-06	1.651E-03	1.213E-01
178	0	0	0.96	2.220E-06	5.503E-04	4.042E-02
179	0	0	0	-2.220E-06	-5.503E-04	-4.042E-02
180	0	0	0	-6.661E-06	-1.651E-03	-1.213E-01
181	0	0	0	-6.661E-06	-1.651E-03	-1.213E-01
182	1.2	6.3	0	-6.661E-06	-1.651E-03	-1.213E-01
183	2	9.9	0.14	-6.661E-06	-1.651E-03	-1.213E-01
184	5.1	12	0.51	-6.661E-06	-1.651E-03	-1.213E-01
185	4.6	8.7	0.72	-6.661E-06	-1.651E-03	-1.213E-01
186	0	0	0.84	-6.661E-06	-1.651E-03	-1.213E-01
187	0	0	0.93	-6.661E-06	-1.651E-03	-1.213E-01
188	0	0	0.71	-6.661E-06	-1.651E-03	-1.213E-01
189	0	0	0	-6.661E-06	-1.651E-03	-1.213E-01
199	0	0	0	-6.661E-06	-1.651E-03	-1.213E-01
200	0	0	0	-7.610E-07	-4.944E-03	1.232E+00
201	0	0	0	5.139E-06	-8.238E-03	2.586E+00
202	0	0	0	1.104E-05	-1.153E-02	3.939E+00
206	0	0	0	1.104E-05	-1.153E-02	3.939E+00
207	1.1	9.2	0.02	1.104E-05	-1.153E-02	3.939E+00
208	5.9	22	0.55	1.104E-05	-1.153E-02	3.939E+00
209	6.7	24.1	1.47	1.104E-05	-1.153E-02	3.939E+00
210	7	18.6	2.39	1.104E-05	-1.153E-02	3.939E+00

211	14.8	11.2	2.79	1.104E-05	-1.153E-02	3.939E+00
212	24.9	10.8	3.23	1.104E-05	-1.153E-02	3.939E+00
213	37.7	8.2	3.78	1.104E-05	-1.153E-02	3.939E+00
214	50.4	7.7	4.33	1.104E-05	-1.153E-02	3.939E+00
215	62.3	8.3	4.84	1.104E-05	-1.153E-02	3.939E+00
216	30.7	4.7	4.37	1.104E-05	-1.153E-02	3.939E+00
217	34.2	19.4	4.69	1.104E-05	-1.153E-02	3.939E+00
218	52.4	12.2	5.72	1.104E-05	-1.153E-02	3.939E+00
219	63.4	7.7	6.35	3.680E-06	-3.844E-03	1.313E+00
220	46.8	0.5	6.78	-3.680E-06	3.844E-03	-1.313E+00
221	41.8	2.7	6.57	-1.104E-05	1.153E-02	-3.939E+00
222	38.8	3.8	6.35	-1.104E-05	1.153E-02	-3.939E+00
223	36.3	4.7	6.17	-1.104E-05	1.153E-02	-3.939E+00
224	36.1	3.5	6.16	-1.104E-05	1.153E-02	-3.939E+00
225	35.4	1.6	6.11	-1.104E-05	1.153E-02	-3.939E+00
226	34.9	( <sup>c</sup> )	6.08	-1.104E-05	1.153E-02	-3.939E+00
227	29.9	( <sup>c</sup> )	5.72	-1.104E-05	1.153E-02	-3.939E+00
228	24.6	( <sup>c</sup> )	5.34	-1.104E-05	1.153E-02	-3.939E+00
229	17.9	( <sup>c</sup> )	4.87	-1.104E-05	1.153E-02	-3.939E+00
230	17.3	16.4	4.41	-1.104E-05	1.153E-02	-3.939E+00
231	22	( <sup>c</sup> )	4.05	-1.104E-05	1.153E-02	-3.939E+00
232	14.1	( <sup>c</sup> )	3.6	-1.104E-05	1.153E-02	-3.939E+00
233	5.4	1.4	3.26	-1.104E-05	1.153E-02	-3.939E+00
234	0.1	5.8	2.63	-1.104E-05	1.153E-02	-3.939E+00
235	0	0	2.18	-1.104E-05	1.153E-02	-3.939E+00
236	0	0	1.93	-1.104E-05	1.153E-02	-3.939E+00
237	0	0	1.6	-1.104E-05	1.153E-02	-3.939E+00
238	0	0	1.23	-3.680E-06	3.844E-03	-1.313E+00
239	0	0	0	3.680E-06	-3.844E-03	1.313E+00
240	0	0	0	1.104E-05	-1.153E-02	3.939E+00
249	0	0	0	1.104E-05	-1.153E-02	3.939E+00
250	1	5.3	0.19	1.104E-05	-1.153E-02	3.939E+00
251	1.1	9.9	0.83	1.104E-05	-1.153E-02	3.939E+00
252	3.4	9.1	1.57	1.104E-05	-1.153E-02	3.939E+00
253	1.1	7.6	2.11	1.104E-05	-1.153E-02	3.939E+00
254	2.8	9.5	2.28	1.104E-05	-1.153E-02	3.939E+00
255	7.7	11.8	2.49	1.104E-05	-1.153E-02	3.939E+00
256	11.9	14.4	2.66	1.104E-05	-1.153E-02	3.939E+00
257	19.1	14.4	2.98	1.104E-05	-1.153E-02	3.939E+00
258	34.6	10.2	3.64	1.104E-05	-1.153E-02	3.939E+00
259	48	9.5	4.22	1.104E-05	-1.153E-02	3.939E+00
260	57.2	10.1	4.62	1.104E-05	-1.153E-02	3.939E+00
261	52	12.7	4.84	1.104E-05	-1.153E-02	3.939E+00
262	40.4	23.7	5.03	1.104E-05	-1.153E-02	3.939E+00
263	69.3	13.6	6.67	1.104E-05	-1.153E-02	3.939E+00
264	58.9	7.7	7.26	1.104E-05	-1.153E-02	3.939E+00
265	59.1	17.7	7.77	1.104E-05	-1.153E-02	3.939E+00
266	67.1	6.2	8.37	3.680E-06	-3.844E-03	1.313E+00
267	43.5	2.9	8.25	-3.680E-06	3.844E-03	-1.313E+00
268	35.8	( <sup>c</sup> )	7.87	-1.104E-05	1.153E-02	-3.939E+00
269	24.1	( <sup>c</sup> )	6.81	-1.104E-05	1.153E-02	-3.939E+00
270	14	12.1	5.29	-1.104E-05	1.153E-02	-3.939E+00
271	18.6	9.1	3.71	-1.104E-05	1.153E-02	-3.939E+00
272	0	0	2.81	-1.104E-05	1.153E-02	-3.939E+00
273	0	0	2.43	-1.104E-05	1.153E-02	-3.939E+00
274	0	0	1.88	-1.104E-05	1.153E-02	-3.939E+00
275	0	0	1.27	-1.104E-05	1.153E-02	-3.939E+00
276	0	0	0	-1.104E-05	1.153E-02	-3.939E+00
299	0	0	0	-1.104E-05	1.153E-02	-3.939E+00
300	0	0	0	-5.060E-06	5.253E-03	-2.462E+00
301	0	0	0	9.196E-07	-1.025E-03	-9.843E-01
302	0	0	0	6.899E-06	-7.304E-03	4.932E-01
314	0	0	0	6.899E-06	-7.304E-03	4.932E-01
315	0.9	9	0.08	6.899E-06	-7.304E-03	4.932E-01
316	7.2	32.1	0.9	6.899E-06	-7.304E-03	4.932E-01
317	8.2	21.3	2.5	6.899E-06	-7.304E-03	4.932E-01
318	19.5	20.4	2.98	6.899E-06	-7.304E-03	4.932E-01
319	35.5	11	3.68	6.899E-06	-7.304E-03	4.932E-01
320	54.3	10.6	4.49	6.899E-06	-7.304E-03	4.932E-01
321	59.1	13.7	4.93	6.899E-06	-7.304E-03	4.932E-01
322	28	5.9	4.13	6.899E-06	-7.304E-03	4.932E-01
323	35	17.6	4.75	6.899E-06	-7.304E-03	4.932E-01

324	50.2	9.8	5.61	6.899E-06	-7.304E-03	4.932E-01
325	62.3	5.7	6.29	6.899E-06	-7.304E-03	4.932E-01
326	52.2	3.7	6.99	6.899E-06	-7.304E-03	4.932E-01
327	47.5	(°)	6.98	6.899E-06	-7.304E-03	4.932E-01
328	43.5	(°)	6.7	6.899E-06	-7.304E-03	4.932E-01
329	39.8	3.7	6.42	6.899E-06	-7.304E-03	4.932E-01
330	44.2	7.2	6.73	6.899E-06	-7.304E-03	4.932E-01
331	54.1	7.2	7.43	6.899E-06	-7.304E-03	4.932E-01
332	60.4	10.3	7.88	6.899E-06	-7.304E-03	4.932E-01
333	70.3	13.2	8.51	6.899E-06	-7.304E-03	4.932E-01
334	41.7	2.3	8.39	6.899E-06	-7.304E-03	4.932E-01
335	57.1	18.5	9.77	6.899E-06	-7.304E-03	4.932E-01
336	74.6	21.3	11.37	6.899E-06	-7.304E-03	4.932E-01
337	60.4	9.2	11.8	6.899E-06	-7.304E-03	4.932E-01
338	56	33.9	12.3	6.899E-06	-7.304E-03	4.932E-01
339	72.4	35.4	14.2	6.899E-06	-7.304E-03	4.932E-01
340	86.3	23.8	15.85	6.899E-06	-7.304E-03	4.932E-01
341	37	0.5	15.94	6.899E-06	-7.304E-03	4.932E-01
342	38.1	32.8	16.49	6.899E-06	-7.304E-03	4.932E-01
343	44.6	28.9	17.72	6.899E-06	-7.304E-03	4.932E-01
344	49.2	17.2	18.61	6.899E-06	-7.304E-03	4.932E-01
345	50.2	0.1	18.82	2.300E-06	-2.435E-03	1.644E-01
346	48.5	(°)	18.52	-2.300E-06	2.435E-03	-1.644E-01
347	46.7	(°)	18.17	-6.899E-06	7.304E-03	-4.932E-01
348	43.9	(°)	17.66	-6.899E-06	7.304E-03	-4.932E-01
349	41.2	(°)	17.14	-6.899E-06	7.304E-03	-4.932E-01
350	38	(°)	16.55	-6.899E-06	7.304E-03	-4.932E-01
351	34	(°)	15.8	-6.899E-06	7.304E-03	-4.932E-01
352	28.8	(°)	14.83	-6.899E-06	7.304E-03	-4.932E-01
353	21.2	(°)	13.42	-6.899E-06	7.304E-03	-4.932E-01
354	31.1	5.3	11.61	-6.899E-06	7.304E-03	-4.932E-01
355	18.6	(°)	10.13	-6.899E-06	7.304E-03	-4.932E-01
356	13	(°)	9.29	-6.899E-06	7.304E-03	-4.932E-01
357	23.6	12.3	8.6	-6.899E-06	7.304E-03	-4.932E-01
358	14.2	(°)	7.51	-6.899E-06	7.304E-03	-4.932E-01
359	14.2	5.5	5.49	-6.899E-06	7.304E-03	-4.932E-01
360	19.1	12.4	3.82	-6.899E-06	7.304E-03	-4.932E-01
361	0	0	2.45	-6.899E-06	7.304E-03	-4.932E-01
362	0.1	5.6	1.45	-6.899E-06	7.304E-03	-4.932E-01
363	0	0	0.71	-6.899E-06	7.304E-03	-4.932E-01
364	0	0	0	-6.899E-06	7.304E-03	-4.932E-01
399	0	0	0	-6.899E-06	7.304E-03	-4.932E-01
400	0	0	0	-2.724E-06	2.689E-03	2.988E-01
401	0	0	0	1.450E-06	-1.927E-03	1.091E+00
402	0	0	0	5.625E-06	-6.542E-03	1.883E+00
421	0	0	0	5.625E-06	-6.542E-03	1.883E+00
422	0.6	9.9	0.03	5.625E-06	-6.542E-03	1.883E+00
423	5	14	0.21	5.625E-06	-6.542E-03	1.883E+00
424	5.1	12.1	0.57	5.625E-06	-6.542E-03	1.883E+00
425	1.7	7.9	0.71	5.625E-06	-6.542E-03	1.883E+00
426	0.1	5.8	0.6	5.625E-06	-6.542E-03	1.883E+00
427	0	0	0	5.625E-06	-6.542E-03	1.883E+00
435	0	0	0	5.625E-06	-6.542E-03	1.883E+00
436	4.4	15.4	0.06	5.625E-06	-6.542E-03	1.883E+00
437	6	20.4	0.92	5.625E-06	-6.542E-03	1.883E+00
438	6	14.1	1.52	5.625E-06	-6.542E-03	1.883E+00
439	6	10.3	1.84	5.625E-06	-6.542E-03	1.883E+00
440	4.4	8.7	2.03	5.625E-06	-6.542E-03	1.883E+00
441	2.5	9.1	2.09	5.625E-06	-6.542E-03	1.883E+00
442	7.5	15.1	2.24	5.625E-06	-6.542E-03	1.883E+00
443	12	13.2	2.68	5.625E-06	-6.542E-03	1.883E+00
444	24.5	12.2	3.21	5.625E-06	-6.542E-03	1.883E+00
445	45.3	9.5	4.1	5.625E-06	-6.542E-03	1.883E+00
446	68.4	11.4	5.09	5.625E-06	-6.542E-03	1.883E+00
447	45.7	1.5	5.35	5.625E-06	-6.542E-03	1.883E+00
448	72.7	23	6.84	5.625E-06	-6.542E-03	1.883E+00
449	64.8	9.8	7.54	5.625E-06	-6.542E-03	1.883E+00
450	66.2	29.8	8.25	5.625E-06	-6.542E-03	1.883E+00
451	86.5	23.4	9.88	5.625E-06	-6.542E-03	1.883E+00
452	36.8	2.3	10.12	5.625E-06	-6.542E-03	1.883E+00
453	43.3	21.8	10.84	5.625E-06	-6.542E-03	1.883E+00
454	51.4	24.5	11.78	5.625E-06	-6.542E-03	1.883E+00

455	58.2	21.2	12.58	5.625E-06	-6.542E-03	1.883E+00
456	60.8	16.9	12.9	5.625E-06	-6.542E-03	1.883E+00
457	34.8	0.7	12.15	5.625E-06	-6.542E-03	1.883E+00
458	34.4	31.3	12.41	5.625E-06	-6.542E-03	1.883E+00
459	36.8	2.8	12.8	5.625E-06	-6.542E-03	1.883E+00
460	36	(°)	12.7	5.625E-06	-6.542E-03	1.883E+00
461	35.9	(°)	12.7	5.625E-06	-6.542E-03	1.883E+00
462	31.1	(°)	11.97	5.625E-06	-6.542E-03	1.883E+00
463	25	5.7	11.05	5.625E-06	-6.542E-03	1.883E+00
464	24.2	0.4	10.94	5.625E-06	-6.542E-03	1.883E+00
465	22.1	3.9	10.64	5.625E-06	-6.542E-03	1.883E+00
466	22.4	30.1	10.65	5.625E-06	-6.542E-03	1.883E+00
467	28.8	20.2	11.59	1.875E-06	-2.181E-03	6.276E-01
468	30.6	1.6	11.89	-1.875E-06	2.181E-03	-6.276E-01
469	27.9	(°)	11.5	-5.625E-06	6.542E-03	-1.883E+00
470	21.3	(°)	10.54	-5.625E-06	6.542E-03	-1.883E+00
471	13.9	(°)	9.43	-5.625E-06	6.542E-03	-1.883E+00
472	25.3	11.7	8.58	-5.625E-06	6.542E-03	-1.883E+00
473	17.8	(°)	7.91	-5.625E-06	6.542E-03	-1.883E+00
474	12.1	1.4	7.29	-5.625E-06	6.542E-03	-1.883E+00
475	24.1	(°)	6.8	-5.625E-06	6.542E-03	-1.883E+00
476	16.4	(°)	6.09	-5.625E-06	6.542E-03	-1.883E+00
477	21.6	16.5	5.65	-5.625E-06	6.542E-03	-1.883E+00
478	26.4	(°)	5.48	-5.625E-06	6.542E-03	-1.883E+00
479	16.2	(°)	4.74	-5.625E-06	6.542E-03	-1.883E+00
480	24.6	10.5	4.03	-5.625E-06	6.542E-03	-1.883E+00
481	8.2	1.1	3.27	-5.625E-06	6.542E-03	-1.883E+00
482	0	0	2.33	-5.625E-06	6.542E-03	-1.883E+00
483	0	0	1.15	-5.625E-06	6.542E-03	-1.883E+00
484	0	0	0.43	-5.625E-06	6.542E-03	-1.883E+00
485	0	0	0	-5.625E-06	6.542E-03	-1.883E+00
499	0	0	0	-5.625E-06	6.542E-03	-1.883E+00
500	0	0	0	-1.425E-06	1.947E-03	-4.329E-01
501	0	0	0	2.774E-06	-2.648E-03	1.017E+00
502	0	0	0	6.974E-06	-7.244E-03	2.467E+00
511	0	0	0	6.974E-06	-7.244E-03	2.467E+00
512	7.5	45.3	0.58	6.974E-06	-7.244E-03	2.467E+00
513	6.5	32.7	1.79	6.974E-06	-7.244E-03	2.467E+00
514	7.6	23.8	2.49	6.974E-06	-7.244E-03	2.467E+00
515	12.7	8.8	2.71	6.974E-06	-7.244E-03	2.467E+00
516	18.8	14.4	2.96	6.974E-06	-7.244E-03	2.467E+00
517	30.4	12.7	3.47	6.974E-06	-7.244E-03	2.467E+00
518	44	10.6	4.05	6.974E-06	-7.244E-03	2.467E+00
519	53.2	8.3	4.46	6.974E-06	-7.244E-03	2.467E+00
520	57.7	10	4.65	6.974E-06	-7.244E-03	2.467E+00
521	48.5	11.5	4.82	6.974E-06	-7.244E-03	2.467E+00
522	33.7	25.7	4.67	6.974E-06	-7.244E-03	2.467E+00
523	49.9	16	5.59	6.974E-06	-7.244E-03	2.467E+00
524	68.1	20.4	6.6	6.974E-06	-7.244E-03	2.467E+00
525	50.4	5.3	6.85	6.974E-06	-7.244E-03	2.467E+00
526	51.1	21.9	7.21	6.974E-06	-7.244E-03	2.467E+00
527	65	22.8	8.2	6.974E-06	-7.244E-03	2.467E+00
528	78.1	19.5	9.02	6.974E-06	-7.244E-03	2.467E+00
529	46.8	2.9	8.85	6.974E-06	-7.244E-03	2.467E+00
530	51.1	19.3	9.24	6.974E-06	-7.244E-03	2.467E+00
531	59.7	26.7	10.01	6.974E-06	-7.244E-03	2.467E+00
532	68.8	23.9	10.86	6.974E-06	-7.244E-03	2.467E+00
533	45	0.5	10.83	6.974E-06	-7.244E-03	2.467E+00
534	46.8	44.3	11.24	6.974E-06	-7.244E-03	2.467E+00
535	55.7	25	12.3	6.974E-06	-7.244E-03	2.467E+00
536	58.9	11.6	12.68	6.974E-06	-7.244E-03	2.467E+00
537	45.1	8.5	12.61	6.974E-06	-7.244E-03	2.467E+00
538	35.7	39.3	12.6	6.974E-06	-7.244E-03	2.467E+00
539	43.2	34.4	13.7	6.974E-06	-7.244E-03	2.467E+00
540	46.2	16.8	14.18	2.325E-06	-2.415E-03	8.223E-01
541	46.7	9.6	14.25	-2.325E-06	2.415E-03	-8.223E-01
542	45.6	(°)	14.1	-6.974E-06	7.244E-03	-2.467E+00
543	42.7	(°)	13.67	-6.974E-06	7.244E-03	-2.467E+00
544	38.4	(°)	13.04	-6.974E-06	7.244E-03	-2.467E+00
545	33.4	(°)	12.3	-6.974E-06	7.244E-03	-2.467E+00
546	28	(°)	11.51	-6.974E-06	7.244E-03	-2.467E+00
547	23.9	(°)	10.9	-6.974E-06	7.244E-03	-2.467E+00

548	18.9	(°)	10.18	-6.974E-06	7.244E-03	-2.467E+00
549	12.9	8.6	8.96	-6.974E-06	7.244E-03	-2.467E+00
550	15.4	(°)	7.54	-6.974E-06	7.244E-03	-2.467E+00
551	25.2	8.4	6.62	-6.974E-06	7.244E-03	-2.467E+00
552	11.1	2.8	5.48	-6.974E-06	7.244E-03	-2.467E+00
553	15.6	6.4	3.51	-6.974E-06	7.244E-03	-2.467E+00
554	0.3	13.3	2.71	-2.325E-06	2.415E-03	-8.223E-01
555	3.8	31.8	3.01	2.325E-06	-2.415E-03	8.223E-01
556	16.6	25.5	3.73	6.974E-06	-7.244E-03	2.467E+00
557	25.4	25.7	4.22	6.974E-06	-7.244E-03	2.467E+00
558	48.8	26.5	5.52	6.974E-06	-7.244E-03	2.467E+00
559	77.9	30.8	7.14	6.974E-06	-7.244E-03	2.467E+00
560	55.5	3.1	7.32	6.974E-06	-7.244E-03	2.467E+00
561	61	36.7	7.9	6.974E-06	-7.244E-03	2.467E+00
562	78.8	26.1	9.19	6.974E-06	-7.244E-03	2.467E+00
563	65.7	26	9.75	6.974E-06	-7.244E-03	2.467E+00
564	31.5	17.9	9.49	6.974E-06	-7.244E-03	2.467E+00
565	43.2	45.2	10.82	6.974E-06	-7.244E-03	2.467E+00
566	48.7	15.9	11.49	6.974E-06	-7.244E-03	2.467E+00
567	49.3	10.9	11.57	6.974E-06	-7.244E-03	2.467E+00
568	50.1	12.6	11.66	6.974E-06	-7.244E-03	2.467E+00
569	56.6	37.8	12.39	6.974E-06	-7.244E-03	2.467E+00
570	61.9	18.7	13.03	6.974E-06	-7.244E-03	2.467E+00
571	64.6	12.8	13.17	6.974E-06	-7.244E-03	2.467E+00
572	37.2	2.8	12.85	6.974E-06	-7.244E-03	2.467E+00
573	44.1	64.1	13.82	6.974E-06	-7.244E-03	2.467E+00
574	53.1	39.7	15.16	6.974E-06	-7.244E-03	2.467E+00
575	56.8	23.5	15.73	6.974E-06	-7.244E-03	2.467E+00
576	59.2	24.4	16.07	6.974E-06	-7.244E-03	2.467E+00
577	43.3	7.9	16.09	6.974E-06	-7.244E-03	2.467E+00
578	35.4	41.4	16.01	6.974E-06	-7.244E-03	2.467E+00
579	37.7	21.3	16.47	6.974E-06	-7.244E-03	2.467E+00
580	37.9	17.9	16.49	6.974E-06	-7.244E-03	2.467E+00
581	38.4	17.3	16.59	2.325E-06	-2.415E-03	8.223E-01
582	38.8	13.3	16.67	-2.325E-06	2.415E-03	-8.223E-01
583	37.4	10.8	16.41	-6.974E-06	7.244E-03	-2.467E+00
584	36.6	11.5	16.26	-6.974E-06	7.244E-03	-2.467E+00
585	34.8	6.5	15.92	-6.974E-06	7.244E-03	-2.467E+00
586	33	(°)	15.59	-6.974E-06	7.244E-03	-2.467E+00
587	29.9	(°)	15.04	-6.974E-06	7.244E-03	-2.467E+00
588	24	(°)	13.92	-6.974E-06	7.244E-03	-2.467E+00
589	29.3	13.3	12.46	-6.974E-06	7.244E-03	-2.467E+00
590	20.2	(°)	10.38	-6.974E-06	7.244E-03	-2.467E+00
591	17	14.9	8.45	-6.974E-06	7.244E-03	-2.467E+00
592	15.4	8.8	5.03	-6.974E-06	7.244E-03	-2.467E+00
593	2.5	1.3	2.58	-6.974E-06	7.244E-03	-2.467E+00
594	0.1	5.7	1.52	-6.974E-06	7.244E-03	-2.467E+00
595	0	0	1.09	-6.974E-06	7.244E-03	-2.467E+00
596	0	0	0.71	-2.325E-06	2.415E-03	-8.223E-01
597	0	0	0	2.325E-06	-2.415E-03	8.223E-01
598	0	0	0	6.974E-06	-7.244E-03	2.467E+00
599	6.4	30.8	0.13	6.974E-06	-7.244E-03	2.467E+00
600	6.8	38.6	1.14	6.974E-06	-7.244E-03	2.467E+00
601	6.7	31.6	2.17	6.974E-06	-7.244E-03	2.467E+00
602	12.7	18.1	2.71	6.974E-06	-7.244E-03	2.467E+00
603	25.1	8.8	3.25	6.974E-06	-7.244E-03	2.467E+00
604	31.3	14	3.51	6.974E-06	-7.244E-03	2.467E+00
605	48.5	8.2	4.25	6.974E-06	-7.244E-03	2.467E+00
606	57.3	7.4	4.63	6.974E-06	-7.244E-03	2.467E+00
607	49.5	15	4.48	6.974E-06	-7.244E-03	2.467E+00
608	16.2	6.7	3.48	6.974E-06	-7.244E-03	2.467E+00
609	29.3	45.7	4.41	6.974E-06	-7.244E-03	2.467E+00
610	69.5	40.4	6.66	6.974E-06	-7.244E-03	2.467E+00
611	70.3	25.8	7.73	6.974E-06	-7.244E-03	2.467E+00
612	35.7	13.9	7.84	6.974E-06	-7.244E-03	2.467E+00
613	38	4.9	8.05	6.974E-06	-7.244E-03	2.467E+00
614	37.8	4.4	8.04	6.974E-06	-7.244E-03	2.467E+00
615	37.5	4.3	8.01	6.974E-06	-7.244E-03	2.467E+00
616	37.3	4.3	7.99	6.974E-06	-7.244E-03	2.467E+00
617	37	4.4	7.96	6.974E-06	-7.244E-03	2.467E+00
618	36.7	4.4	7.94	6.974E-06	-7.244E-03	2.467E+00
619	36.5	4.5	7.92	6.974E-06	-7.244E-03	2.467E+00

620	36.9	12.3	7.95	6.974E-06	-7.244E-03	2.467E+00
621	44.6	20.6	8.65	6.974E-06	-7.244E-03	2.467E+00
622	51.4	10.4	9.28	6.974E-06	-7.244E-03	2.467E+00
623	53.7	(°)	9.49	6.974E-06	-7.244E-03	2.467E+00
624	53.5	(°)	9.48	6.974E-06	-7.244E-03	2.467E+00
625	54.2	16.7	9.52	6.974E-06	-7.244E-03	2.467E+00
626	62.2	18.4	10.26	6.974E-06	-7.244E-03	2.467E+00
627	65.7	8.9	10.78	6.974E-06	-7.244E-03	2.467E+00
628	43.8	(°)	10.94	6.974E-06	-7.244E-03	2.467E+00
629	42.4	1.5	10.77	6.974E-06	-7.244E-03	2.467E+00
630	41.8	4.6	10.7	6.974E-06	-7.244E-03	2.467E+00
631	41.6	5.1	10.67	6.974E-06	-7.244E-03	2.467E+00
632	41.4	5.1	10.66	6.974E-06	-7.244E-03	2.467E+00
633	41.3	5.2	10.65	6.974E-06	-7.244E-03	2.467E+00
634	41.2	5.2	10.63	6.974E-06	-7.244E-03	2.467E+00
635	41.1	5.2	10.62	6.974E-06	-7.244E-03	2.467E+00
636	41	5.2	10.61	6.974E-06	-7.244E-03	2.467E+00
637	41	5.3	10.6	6.974E-06	-7.244E-03	2.467E+00
638	40.9	5.3	10.59	6.974E-06	-7.244E-03	2.467E+00
639	40.8	5.3	10.58	6.974E-06	-7.244E-03	2.467E+00
640	40.7	5.3	10.58	6.974E-06	-7.244E-03	2.467E+00
641	42.1	13.3	10.73	6.974E-06	-7.244E-03	2.467E+00
642	45.4	13.6	11.11	6.974E-06	-7.244E-03	2.467E+00
643	50.5	9.9	11.71	6.974E-06	-7.244E-03	2.467E+00
644	53.2	5.7	12.03	6.974E-06	-7.244E-03	2.467E+00
645	54.6	(°)	12.2	6.974E-06	-7.244E-03	2.467E+00
646	53.9	0.3	12.12	6.974E-06	-7.244E-03	2.467E+00
647	53.3	4.7	12.04	6.974E-06	-7.244E-03	2.467E+00
648	53.1	5.3	12.02	6.974E-06	-7.244E-03	2.467E+00
649	53.1	5.4	12.01	4.837E-06	-5.146E-03	1.740E+00
650	53	5.4	12.01	2.700E-06	-3.048E-03	1.013E+00
651	53	5.4	12	5.632E-07	-9.497E-04	2.854E-01
652	52.9	5.4	12	5.632E-07	-9.497E-04	2.854E-01
653	52.9	5.4	12	5.632E-07	-9.497E-04	2.854E-01
654	52.9	5.4	11.99	5.632E-07	-9.497E-04	2.854E-01
655	52.8	5.4	11.99	5.632E-07	-9.497E-04	2.854E-01
656	52.8	5.4	11.98	5.632E-07	-9.497E-04	2.854E-01
657	52.8	5.4	11.98	5.632E-07	-9.497E-04	2.854E-01
658	52.8	5.4	11.98	5.632E-07	-9.497E-04	2.854E-01
659	52.7	5.4	11.97	5.632E-07	-9.497E-04	2.854E-01
660	55.2	16.3	12.25	5.632E-07	-9.497E-04	2.854E-01
661	58.7	16.1	12.65	5.632E-07	-9.497E-04	2.854E-01
662	54	10.8	12.89	5.632E-07	-9.497E-04	2.854E-01
663	38.1	35.5	12.97	5.632E-07	-9.497E-04	2.854E-01
664	44.3	23.7	13.88	5.632E-07	-9.497E-04	2.854E-01
665	46.3	1.7	14.19	5.632E-07	-9.497E-04	2.854E-01
666	46.4	(°)	14.22	5.632E-07	-9.497E-04	2.854E-01
667	45.8	7.8	14.11	5.632E-07	-9.497E-04	2.854E-01
668	50.4	34.7	14.77	5.632E-07	-9.497E-04	2.854E-01
669	54.7	15.2	15.43	5.632E-07	-9.497E-04	2.854E-01
670	57.6	(°)	15.88	5.632E-07	-9.497E-04	2.854E-01
671	54.1	(°)	15.37	5.632E-07	-9.497E-04	2.854E-01
672	52.1	(°)	15.06	5.632E-07	-9.497E-04	2.854E-01
673	52	(°)	15.04	5.632E-07	-9.497E-04	2.854E-01
674	51.3	5.7	14.94	5.632E-07	-9.497E-04	2.854E-01
675	51.3	6.8	14.93	5.632E-07	-9.497E-04	2.854E-01
676	51.6	11.2	14.97	5.632E-07	-9.497E-04	2.854E-01
677	54.2	11.5	15.35	5.632E-07	-9.497E-04	2.854E-01
678	54.7	16.5	15.43	5.632E-07	-9.497E-04	2.854E-01
679	54.4	22.6	15.38	5.632E-07	-9.497E-04	2.854E-01
680	55.3	8.6	15.52	5.632E-07	-9.497E-04	2.854E-01
681	55.8	1.3	15.6	5.632E-07	-9.497E-04	2.854E-01
682	55.5	4.3	15.56	5.632E-07	-9.497E-04	2.854E-01
683	55.3	6.3	15.53	5.632E-07	-9.497E-04	2.854E-01
684	55.3	6.5	15.52	5.632E-07	-9.497E-04	2.854E-01
685	55.3	6.5	15.52	5.632E-07	-9.497E-04	2.854E-01
686	55.3	6.5	15.52	5.632E-07	-9.497E-04	2.854E-01
687	55.3	6.5	15.51	5.632E-07	-9.497E-04	2.854E-01
688	55.2	4.8	15.51	5.632E-07	-9.497E-04	2.854E-01
689	54.4	2.7	15.39	5.632E-07	-9.497E-04	2.854E-01
690	55.2	(°)	15.52	5.632E-07	-9.497E-04	2.854E-01
691	54.2	13.3	15.36	5.632E-07	-9.497E-04	2.854E-01



692	54.1	11.8	15.34	5.632E-07	-9.497E-04	2.854E-01
693	54.7	5.3	15.43	5.632E-07	-9.497E-04	2.854E-01
694	55.4	(°)	15.54	5.632E-07	-9.497E-04	2.854E-01
695	54.9	1.9	15.46	5.632E-07	-9.497E-04	2.854E-01
696	54.5	6.2	15.4	5.632E-07	-9.497E-04	2.854E-01
697	54.5	7.2	15.41	5.632E-07	-9.497E-04	2.854E-01
698	54.5	6.3	15.41	5.632E-07	-9.497E-04	2.854E-01
699	54	(°)	15.33	4.087E-07	-8.219E-04	3.495E-01
700	54.8	(°)	15.46	2.542E-07	-6.940E-04	4.136E-01
701	54.1	(°)	15.36	9.973E-08	-5.661E-04	4.778E-01
702	53.2	6.7	15.21	9.973E-08	-5.661E-04	4.778E-01
703	53.5	5.8	15.25	9.973E-08	-5.661E-04	4.778E-01
704	53	(°)	15.19	9.973E-08	-5.661E-04	4.778E-01
705	50.9	8.6	14.87	9.973E-08	-5.661E-04	4.778E-01
706	50.7	11.7	14.84	9.973E-08	-5.661E-04	4.778E-01
707	51.1	7.8	14.9	9.973E-08	-5.661E-04	4.778E-01
708	51.2	6.6	14.92	9.973E-08	-5.661E-04	4.778E-01
709	51.2	6.5	14.92	9.973E-08	-5.661E-04	4.778E-01
710	51.2	6.5	14.92	9.973E-08	-5.661E-04	4.778E-01
711	51.2	6.5	14.92	9.973E-08	-5.661E-04	4.778E-01
712	51.3	6.5	14.92	9.973E-08	-5.661E-04	4.778E-01
713	51.3	6.5	14.92	9.973E-08	-5.661E-04	4.778E-01
714	51.3	6.5	14.93	9.973E-08	-5.661E-04	4.778E-01
732	51.3	6.5	14.93	9.973E-08	-5.661E-04	4.778E-01
733	51.3	6.5	14.94	9.973E-08	-5.661E-04	4.778E-01
734	51.4	10.5	14.95	9.973E-08	-5.661E-04	4.778E-01
735	53.1	11.2	15.19	9.973E-08	-5.661E-04	4.778E-01
736	52.9	5.3	15.17	9.973E-08	-5.661E-04	4.778E-01
737	53.8	2.9	15.3	9.973E-08	-5.661E-04	4.778E-01
738	55.5	(°)	15.56	9.973E-08	-5.661E-04	4.778E-01
739	55.1	2	15.5	9.973E-08	-5.661E-04	4.778E-01
740	55.7	6.8	15.58	9.973E-08	-5.661E-04	4.778E-01
741	55.9	5.3	15.61	9.973E-08	-5.661E-04	4.778E-01
742	54.1	18	15.33	9.973E-08	-5.661E-04	4.778E-01
743	53.9	14.8	15.3	9.973E-08	-5.661E-04	4.778E-01
744	55	9.5	15.47	9.973E-08	-5.661E-04	4.778E-01
745	55.4	1.9	15.54	9.973E-08	-5.661E-04	4.778E-01
746	55.7	8.4	15.58	9.973E-08	-5.661E-04	4.778E-01
747	57.4	(°)	15.85	9.973E-08	-5.661E-04	4.778E-01
748	56.7	(°)	15.77	9.973E-08	-5.661E-04	4.778E-01
749	32.2	(°)	15.36	9.973E-08	-5.661E-04	4.778E-01
750	30.2	25.4	15.05	9.973E-08	-5.661E-04	4.778E-01
751	28.9	43.8	14.8	9.973E-08	-5.661E-04	4.778E-01
752	29.6	37.9	14.93	9.973E-08	-5.661E-04	4.778E-01
753	30.5	13.4	15.11	3.324E-08	-1.887E-04	1.593E-01
754	30.6	(°)	15.14	-3.324E-08	1.887E-04	-1.593E-01
755	29.2	(°)	14.88	-9.973E-08	5.661E-04	-4.778E-01
756	28.7	(°)	14.79	-9.973E-08	5.661E-04	-4.778E-01
757	28.2	(°)	14.69	-9.973E-08	5.661E-04	-4.778E-01
758	27.7	8.5	14.6	-9.973E-08	5.661E-04	-4.778E-01
759	27.5	(°)	14.55	-9.973E-08	5.661E-04	-4.778E-01
760	24.9	(°)	14.09	-9.973E-08	5.661E-04	-4.778E-01
761	23.1	(°)	13.76	-9.973E-08	5.661E-04	-4.778E-01
762	21	8.9	12.81	-9.973E-08	5.661E-04	-4.778E-01
763	34.4	(°)	12.32	-9.973E-08	5.661E-04	-4.778E-01
764	30.1	(°)	11.83	-9.973E-08	5.661E-04	-4.778E-01
765	22.8	(°)	10.76	-9.973E-08	5.661E-04	-4.778E-01
766	13.2	(°)	9.35	-9.973E-08	5.661E-04	-4.778E-01
767	17.9	7.1	7.87	-9.973E-08	5.661E-04	-4.778E-01
768	21.7	10.3	6.32	-9.973E-08	5.661E-04	-4.778E-01
769	15.3	(°)	4.47	-9.973E-08	5.661E-04	-4.778E-01
770	0.9	(°)	2.49	-9.973E-08	5.661E-04	-4.778E-01
771	0.1	5.6	1.67	-9.973E-08	5.661E-04	-4.778E-01
772	0	0	1.55	-9.973E-08	5.661E-04	-4.778E-01
773	0	0	1.46	-9.973E-08	5.661E-04	-4.778E-01
774	0	0	0.71	-9.973E-08	5.661E-04	-4.778E-01
775	0	0	0	-9.973E-08	5.661E-04	-4.778E-01
799	0	0	0	-9.973E-08	5.661E-04	-4.778E-01
800	0	0	0	3.522E-06	-3.252E-03	6.821E-01
801	0	0	0	7.144E-06	-7.070E-03	1.842E+00
802	0	0	0	1.077E-05	-1.089E-02	3.002E+00
810	0	0	0	1.077E-05	-1.089E-02	3.002E+00

811	7.7	34.4	1.28	1.077E-05	-1.089E-02	3.002E+00
812	16.2	15.7	2.87	1.077E-05	-1.089E-02	3.002E+00
813	37.9	5.1	3.79	1.077E-05	-1.089E-02	3.002E+00
814	51.4	10.8	4.37	1.077E-05	-1.089E-02	3.002E+00
815	71.1	18.9	5.19	1.077E-05	-1.089E-02	3.002E+00
816	49.8	(°)	5.6	1.077E-05	-1.089E-02	3.002E+00
817	65.6	18.1	6.47	1.077E-05	-1.089E-02	3.002E+00
818	43.5	4.8	6.4	1.077E-05	-1.089E-02	3.002E+00
819	47.4	35.6	6.93	1.077E-05	-1.089E-02	3.002E+00
820	73	32.8	8.77	1.077E-05	-1.089E-02	3.002E+00
821	76.2	29	9.82	1.077E-05	-1.089E-02	3.002E+00
822	33.1	6.8	9.69	1.077E-05	-1.089E-02	3.002E+00
823	44.9	51	11.01	1.077E-05	-1.089E-02	3.002E+00
824	60.1	44.1	12.8	1.077E-05	-1.089E-02	3.002E+00
825	67	22.5	13.62	1.077E-05	-1.089E-02	3.002E+00
826	72.5	28.6	14.25	1.077E-05	-1.089E-02	3.002E+00
827	46	2.8	13.95	1.077E-05	-1.089E-02	3.002E+00
828	51	60.5	14.84	1.077E-05	-1.089E-02	3.002E+00
829	63	33.5	16.62	1.077E-05	-1.089E-02	3.002E+00
830	65.5	25.2	17	1.077E-05	-1.089E-02	3.002E+00
831	57.8	12.7	17.13	1.077E-05	-1.089E-02	3.002E+00
832	40.4	36	16.96	1.077E-05	-1.089E-02	3.002E+00
833	43.6	24.7	17.56	1.077E-05	-1.089E-02	3.002E+00
834	44.1	21.8	17.66	3.588E-06	-3.630E-03	1.001E+00
835	45	10.9	17.84	-3.588E-06	3.630E-03	-1.001E+00
836	44.3	(°)	17.71	-1.077E-05	1.089E-02	-3.002E+00
837	42	(°)	17.28	-1.077E-05	1.089E-02	-3.002E+00
838	38.5	(°)	16.63	-1.077E-05	1.089E-02	-3.002E+00
839	35.3	(°)	16.03	-1.077E-05	1.089E-02	-3.002E+00
840	31.3	(°)	15.29	-1.077E-05	1.089E-02	-3.002E+00
841	24.9	(°)	14.1	-1.077E-05	1.089E-02	-3.002E+00
842	29.1	12.7	12.28	-1.077E-05	1.089E-02	-3.002E+00
843	20.4	(°)	10.41	-1.077E-05	1.089E-02	-3.002E+00
844	14.7	12.9	8.82	-1.077E-05	1.089E-02	-3.002E+00
845	14.7	(°)	7.57	-1.077E-05	1.089E-02	-3.002E+00
846	17.2	6.5	5.93	-1.077E-05	1.089E-02	-3.002E+00
847	16.7	12.3	3.77	-1.077E-05	1.089E-02	-3.002E+00
848	0	0	1.51	-1.077E-05	1.089E-02	-3.002E+00
849	0	0	0	-1.077E-05	1.089E-02	-3.002E+00
864	0	0	0	-1.077E-05	1.089E-02	-3.002E+00
865	0	0	0	-3.199E-06	3.169E-03	-1.698E+00
866	0	0	0	4.367E-06	-4.551E-03	-3.934E-01
867	0	0	0	1.193E-05	-1.227E-02	9.108E-01
869	0	0	0	1.193E-05	-1.227E-02	9.108E-01
870	3	5	0	1.193E-05	-1.227E-02	9.108E-01
871	7	10	0	1.193E-05	-1.227E-02	9.108E-01
872	58.6	22.6	5.59	1.193E-05	-1.227E-02	9.108E-01
873	84.8	19.9	6.92	1.193E-05	-1.227E-02	9.108E-01
874	46.7	3.3	6.66	1.193E-05	-1.227E-02	9.108E-01
875	51.2	10.4	7.09	1.193E-05	-1.227E-02	9.108E-01
876	56.5	10.6	7.46	1.193E-05	-1.227E-02	9.108E-01
877	70.3	14.4	8.4	1.193E-05	-1.227E-02	9.108E-01
878	53.2	10.4	8.86	1.193E-05	-1.227E-02	9.108E-01
879	50.4	34.3	9.51	9.979E-06	-1.043E-02	9.264E-01
880	81.5	54.8	12.38	8.023E-06	-8.594E-03	9.420E-01
881	91.3	5.4	13.38	6.068E-06	-6.755E-03	9.576E-01
882	63.6	10.3	13.29	6.068E-06	-6.755E-03	9.576E-01
883	57.9	37.8	13.65	6.068E-06	-6.755E-03	9.576E-01
884	80.1	61.2	16.37	6.068E-06	-6.755E-03	9.576E-01
885	89.5	24	17.62	6.068E-06	-6.755E-03	9.576E-01
886	60.8	7.4	17.9	6.068E-06	-6.755E-03	9.576E-01
887	57.2	41.9	18.28	6.068E-06	-6.755E-03	9.576E-01
888	65.4	8.4	19.71	6.068E-06	-6.755E-03	9.576E-01
889	65.6	5.5	19.75	5.713E-06	-6.392E-03	4.768E-01
890	35.9	0.3	19.56	5.358E-06	-6.028E-03	-3.992E-03
891	35.4	31.2	19.87	5.004E-06	-5.665E-03	-4.848E-01
892	37.3	19	20.32	5.004E-06	-5.665E-03	-4.848E-01
893	40.5	38	21	5.004E-06	-5.665E-03	-4.848E-01
894	46.4	56.4	22.32	5.004E-06	-5.665E-03	-4.848E-01
895	52.5	39.6	23.74	5.004E-06	-5.665E-03	-4.848E-01
896	54.6	7.8	24.26	5.004E-06	-5.665E-03	-4.848E-01
897	53.3	(°)	23.98	5.004E-06	-5.665E-03	-4.848E-01

898	51.2	(°)	23.51	5.004E-06	-5.665E-03	-4.848E-01
899	49.3	(°)	23.08	3.154E-06	-3.810E-03	-3.535E-01
900	47.4	(°)	22.66	1.304E-06	-1.954E-03	-2.222E-01
901	46	6.4	22.31	-5.462E-07	-9.930E-05	-9.097E-02
902	45.9	7.6	22.29	-5.462E-07	-9.930E-05	-9.097E-02
903	46.4	18.3	22.38	-5.462E-07	-9.930E-05	-9.097E-02
904	48.1	23.5	22.75	-5.462E-07	-9.930E-05	-9.097E-02
905	50	22.5	23.2	-5.462E-07	-9.930E-05	-9.097E-02
906	50.5	8.6	23.34	-5.462E-07	-9.930E-05	-9.097E-02
907	48.9	(°)	22.99	-5.462E-07	-9.930E-05	-9.097E-02
908	48.2	11	22.8	-5.462E-07	-9.930E-05	-9.097E-02
909	47.5	3.6	22.66	9.609E-07	-1.656E-03	1.853E-01
910	48.3	14.9	22.82	2.468E-06	-3.213E-03	4.616E-01
911	48.7	13	22.92	3.975E-06	-4.769E-03	7.379E-01
912	47.8	(°)	22.74	3.975E-06	-4.769E-03	7.379E-01
913	47.8	14.5	22.71	3.975E-06	-4.769E-03	7.379E-01
914	48.3	10.1	22.82	3.975E-06	-4.769E-03	7.379E-01
915	48.3	6.4	22.84	3.975E-06	-4.769E-03	7.379E-01
916	48.2	7	22.8	3.975E-06	-4.769E-03	7.379E-01
917	48.3	12.5	22.83	3.975E-06	-4.769E-03	7.379E-01
918	48.1	6.6	22.79	3.975E-06	-4.769E-03	7.379E-01
919	48.2	12.1	22.79	3.975E-06	-4.769E-03	7.379E-01
920	49.2	17.9	23.02	1.325E-06	-1.590E-03	2.460E-01
921	50.7	11.7	23.36	-1.325E-06	1.590E-03	-2.460E-01
922	49.4	(°)	23.1	-3.975E-06	4.769E-03	-7.379E-01
923	47.2	(°)	22.61	-3.975E-06	4.769E-03	-7.379E-01
924	44.8	(°)	22.06	-3.975E-06	4.769E-03	-7.379E-01
925	42.1	(°)	21.45	-3.975E-06	4.769E-03	-7.379E-01
926	39.1	(°)	20.76	-3.975E-06	4.769E-03	-7.379E-01
927	36.2	(°)	20.11	-3.975E-06	4.769E-03	-7.379E-01
928	33.5	(°)	19.48	-3.975E-06	4.769E-03	-7.379E-01
929	29.8	(°)	18.65	-3.975E-06	4.769E-03	-7.379E-01
930	25.1	(°)	17.59	-3.975E-06	4.769E-03	-7.379E-01
931	20.4	(°)	16.52	-3.975E-06	4.769E-03	-7.379E-01
932	23.8	13.5	15.18	-3.975E-06	4.769E-03	-7.379E-01
933	29.8	1.8	13.26	-3.975E-06	4.769E-03	-7.379E-01
934	15.6	(°)	11.39	-3.975E-06	4.769E-03	-7.379E-01
935	19.4	14.3	9.71	-3.975E-06	4.769E-03	-7.379E-01
936	16.1	(°)	8.52	-3.975E-06	4.769E-03	-7.379E-01
937	16.3	13.1	6.98	-3.975E-06	4.769E-03	-7.379E-01
938	17.8	11.5	4.9	-3.975E-06	4.769E-03	-7.379E-01
939	8.6	1.8	2.92	-3.975E-06	4.769E-03	-7.379E-01
940	0	0	2.39	-3.975E-06	4.769E-03	-7.379E-01
941	0	0	2.44	-3.975E-06	4.769E-03	-7.379E-01
942	0	0	2.37	-3.975E-06	4.769E-03	-7.379E-01
943	1	5	1.67	-3.975E-06	4.769E-03	-7.379E-01
944	5	8.7	1.17	-3.975E-06	4.769E-03	-7.379E-01
945	5.4	7.6	1.34	-3.975E-06	4.769E-03	-7.379E-01
946	0	0	1.28	-3.975E-06	4.769E-03	-7.379E-01
947	0	0	0.56	-1.325E-06	1.590E-03	-2.460E-01
948	0	0	0	1.325E-06	-1.590E-03	2.460E-01
949	0	0	0	3.975E-06	-4.769E-03	7.379E-01
952	0	0	0	3.975E-06	-4.769E-03	7.379E-01
953	5.4	16.3	0.27	3.975E-06	-4.769E-03	7.379E-01
954	7.2	26	1.4	3.975E-06	-4.769E-03	7.379E-01
955	27.1	23	2.96	3.975E-06	-4.769E-03	7.379E-01
956	64.4	18	4.35	3.975E-06	-4.769E-03	7.379E-01
957	44.8	3.7	4.75	3.975E-06	-4.769E-03	7.379E-01
958	60.6	28.7	5.67	3.975E-06	-4.769E-03	7.379E-01
959	92.5	23.9	7.29	3.975E-06	-4.769E-03	7.379E-01
960	53	1.3	7.23	3.975E-06	-4.769E-03	7.379E-01
961	85.2	41.6	9.37	3.975E-06	-4.769E-03	7.379E-01
962	56.3	0.4	9.93	3.975E-06	-4.769E-03	7.379E-01
963	67.8	48.8	11.11	3.975E-06	-4.769E-03	7.379E-01
964	101.7	55.3	13.96	3.975E-06	-4.769E-03	7.379E-01
965	31.9	2.4	13.82	3.975E-06	-4.769E-03	7.379E-01
966	37.3	57.2	14.93	3.975E-06	-4.769E-03	7.379E-01
967	54.7	82.5	17.81	3.975E-06	-4.769E-03	7.379E-01
968	64.3	12.2	19.52	3.975E-06	-4.769E-03	7.379E-01
969	65.1	8.7	19.67	3.461E-06	-4.200E-03	7.130E-01
970	36.8	1	19.69	2.947E-06	-3.630E-03	6.882E-01
971	35.5	20.2	19.9	2.433E-06	-3.060E-03	6.633E-01

972	36.9	14.6	20.23	2.433E-06	-3.060E-03	6.633E-01
973	38.2	14.8	20.52	2.433E-06	-3.060E-03	6.633E-01
974	38.9	8	20.69	8.109E-07	-1.020E-03	2.211E-01
975	39	7.7	20.7	-8.109E-07	1.020E-03	-2.211E-01
976	37.5	(°)	20.38	-2.433E-06	3.060E-03	-6.633E-01
977	35.6	(°)	19.95	-2.433E-06	3.060E-03	-6.633E-01
978	33.1	(°)	19.4	-2.433E-06	3.060E-03	-6.633E-01
979	30	(°)	18.69	-2.433E-06	3.060E-03	-6.633E-01
980	26.2	(°)	17.83	-2.433E-06	3.060E-03	-6.633E-01
981	21.9	(°)	16.86	-2.433E-06	3.060E-03	-6.633E-01
982	18.1	(°)	15.98	-2.433E-06	3.060E-03	-6.633E-01
983	40.7	16.1	15.23	-2.433E-06	3.060E-03	-6.633E-01
984	36	(°)	14.81	-2.433E-06	3.060E-03	-6.633E-01
985	33.7	(°)	14.4	-2.433E-06	3.060E-03	-6.633E-01
986	32	(°)	14.12	-2.433E-06	3.060E-03	-6.633E-01
987	29.3	(°)	13.67	-2.433E-06	3.060E-03	-6.633E-01
988	27	(°)	13.29	-2.433E-06	3.060E-03	-6.633E-01
989	24.6	(°)	12.89	-2.433E-06	3.060E-03	-6.633E-01
990	21.8	(°)	12.41	-2.433E-06	3.060E-03	-6.633E-01
991	18.2	(°)	11.82	-2.433E-06	3.060E-03	-6.633E-01
992	9.9	6.7	9.97	-2.433E-06	3.060E-03	-6.633E-01
993	16	2.1	8.01	-2.433E-06	3.060E-03	-6.633E-01
994	13.4	4	5.89	-2.433E-06	3.060E-03	-6.633E-01
995	11.3	5.7	3.93	-2.433E-06	3.060E-03	-6.633E-01
996	0	0	2.5	-2.433E-06	3.060E-03	-6.633E-01
997	0.3	3.9	2.18	-2.433E-06	3.060E-03	-6.633E-01
998	0.2	3.5	1.91	-2.433E-06	3.060E-03	-6.633E-01
999	0	0	2.01	-2.433E-06	3.060E-03	-6.633E-01
1000	0	0	2.13	-2.433E-06	3.060E-03	-6.633E-01
1001	0	0	2.04	-2.433E-06	3.060E-03	-6.633E-01
1002	0	0	0.61	-2.433E-06	3.060E-03	-6.633E-01
1003	0	0	0	-2.433E-06	3.060E-03	-6.633E-01
1014	0	0	0	-2.433E-06	3.060E-03	-6.633E-01
1015	0	0	0	-1.410E-06	1.623E-03	-4.817E-01
1016	0	0	0	-3.875E-07	1.855E-04	-3.001E-01
1017	1	7.6	0.01	6.352E-07	-1.252E-03	-1.186E-01
1018	7.8	34.2	0.94	6.352E-07	-1.252E-03	-1.186E-01
1019	27.5	19.7	2.99	6.352E-07	-1.252E-03	-1.186E-01
1020	67.8	18.4	4.47	6.352E-07	-1.252E-03	-1.186E-01
1021	39.9	5.8	4.45	6.352E-07	-1.252E-03	-1.186E-01
1022	39.1	27.8	4.59	6.352E-07	-1.252E-03	-1.186E-01
1023	90.5	36.7	7.17	6.352E-07	-1.252E-03	-1.186E-01
1024	55.7	1.3	7.32	6.352E-07	-1.252E-03	-1.186E-01
1025	81.4	46.8	9.1	6.352E-07	-1.252E-03	-1.186E-01
1026	56.6	2.7	9.86	6.352E-07	-1.252E-03	-1.186E-01
1027	62.2	36.5	10.61	6.352E-07	-1.252E-03	-1.186E-01
1028	81	44.1	12.35	6.352E-07	-1.252E-03	-1.186E-01
1029	64.2	11	13.32	6.352E-07	-1.252E-03	-1.186E-01
1030	56.2	37.2	13.44	6.352E-07	-1.252E-03	-1.186E-01
1031	77.1	77.9	15.98	6.352E-07	-1.252E-03	-1.186E-01
1032	103.6	47.7	18.47	6.352E-07	-1.252E-03	-1.186E-01
1033	56.1	2.9	18.15	6.352E-07	-1.252E-03	-1.186E-01
1034	65	62.1	19.55	6.352E-07	-1.252E-03	-1.186E-01
1035	72.1	27.2	20.81	6.352E-07	-1.252E-03	-1.186E-01
1036	75	19.5	21.31	6.352E-07	-1.252E-03	-1.186E-01
1037	42.6	1.6	21.12	6.352E-07	-1.252E-03	-1.186E-01
1038	43.4	47.9	21.65	6.352E-07	-1.252E-03	-1.186E-01
1039	47.3	26.8	22.57	6.352E-07	-1.252E-03	-1.186E-01
1040	49	21.4	22.98	6.352E-07	-1.252E-03	-1.186E-01
1041	50.5	23.2	23.32	6.352E-07	-1.252E-03	-1.186E-01
1042	51.9	20.3	23.63	6.352E-07	-1.252E-03	-1.186E-01
1043	53.2	19.4	23.92	6.352E-07	-1.252E-03	-1.186E-01
1044	54.1	14.5	24.14	6.352E-07	-1.252E-03	-1.186E-01
1045	54	6.5	24.13	6.352E-07	-1.252E-03	-1.186E-01
1046	54.9	26.4	24.3	6.352E-07	-1.252E-03	-1.186E-01
1047	58	38	24.99	6.352E-07	-1.252E-03	-1.186E-01
1048	60.7	25.2	25.63	6.352E-07	-1.252E-03	-1.186E-01
1049	32.4	(°)	25.39	6.352E-07	-1.252E-03	-1.186E-01
1050	29.8	7.6	25.06	6.352E-07	-1.252E-03	-1.186E-01
1051	28.4	(°)	24.66	6.352E-07	-1.252E-03	-1.186E-01
1052	26.2	(°)	23.99	6.352E-07	-1.252E-03	-1.186E-01
1053	25.2	14.1	23.63	6.352E-07	-1.252E-03	-1.186E-01

1054	26.9	47.6	24.13	6.352E-07	-1.252E-03	-1.186E-01
1055	30.5	70.4	25.2	6.352E-07	-1.252E-03	-1.186E-01
1056	32.1	12.2	25.77	6.352E-07	-1.252E-03	-1.186E-01
1057	32.6	26.7	25.89	6.352E-07	-1.252E-03	-1.186E-01
1058	34.5	44	26.46	6.352E-07	-1.252E-03	-1.186E-01
1059	36.5	34.5	27.06	6.352E-07	-1.252E-03	-1.186E-01
1060	37.7	26.5	27.46	6.352E-07	-1.252E-03	-1.186E-01
1061	38.6	23.3	27.72	6.352E-07	-1.252E-03	-1.186E-01
1062	39.3	20.6	27.95	6.352E-07	-1.252E-03	-1.186E-01
1063	39.6	19.9	28.03	6.352E-07	-1.252E-03	-1.186E-01
1064	40.1	23.2	28.19	6.352E-07	-1.252E-03	-1.186E-01
1065	40.7	25.2	28.38	6.352E-07	-1.252E-03	-1.186E-01
1066	41.6	27.3	28.64	6.352E-07	-1.252E-03	-1.186E-01
1067	42.4	23.5	28.9	6.352E-07	-1.252E-03	-1.186E-01
1068	42.9	22.5	29.04	6.352E-07	-1.252E-03	-1.186E-01
1069	43.2	15.8	29.14	6.352E-07	-1.252E-03	-1.186E-01
1070	43.1	15.6	29.13	6.352E-07	-1.252E-03	-1.186E-01
1071	43.2	17.1	29.17	6.352E-07	-1.252E-03	-1.186E-01
1072	43.2	13.8	29.17	6.352E-07	-1.252E-03	-1.186E-01
1073	43.2	14.7	29.15	6.352E-07	-1.252E-03	-1.186E-01
1074	43	22.7	29.09	6.352E-07	-1.252E-03	-1.186E-01
1075	43.8	24.6	29.31	6.352E-07	-1.252E-03	-1.186E-01
1076	44.2	13.7	29.46	6.352E-07	-1.252E-03	-1.186E-01
1077	44	6.9	29.39	6.352E-07	-1.252E-03	-1.186E-01
1078	42.9	( <sup>e</sup> )	29.08	6.352E-07	-1.252E-03	-1.186E-01
1079	41.4	2.9	28.62	6.352E-07	-1.252E-03	-1.186E-01
1080	41	14	28.48	6.352E-07	-1.252E-03	-1.186E-01
1081	41.1	17.7	28.5	6.352E-07	-1.252E-03	-1.186E-01
1082	41.7	15	28.69	6.352E-07	-1.252E-03	-1.186E-01
1083	42.4	19.8	28.91	6.352E-07	-1.252E-03	-1.186E-01
1084	43.5	17.4	29.24	6.352E-07	-1.252E-03	-1.186E-01
1085	44	10.8	29.41	6.352E-07	-1.252E-03	-1.186E-01
1086	44.3	10	29.51	6.352E-07	-1.252E-03	-1.186E-01
1087	44.5	6.5	29.55	6.352E-07	-1.252E-03	-1.186E-01
1088	44.1	0.4	29.46	6.352E-07	-1.252E-03	-1.186E-01
1089	43.4	1.2	29.24	6.352E-07	-1.252E-03	-1.186E-01
1090	43.2	7.3	29.17	6.352E-07	-1.252E-03	-1.186E-01
1091	43.1	4.7	29.14	6.352E-07	-1.252E-03	-1.186E-01
1092	42.8	4.7	29.04	6.352E-07	-1.252E-03	-1.186E-01
1093	42.6	5.8	28.97	6.352E-07	-1.252E-03	-1.186E-01
1094	42.6	9.8	28.97	6.352E-07	-1.252E-03	-1.186E-01
1095	42.9	13.4	29.06	6.352E-07	-1.252E-03	-1.186E-01
1096	43.4	19	29.22	6.352E-07	-1.252E-03	-1.186E-01
1097	44.2	15	29.47	6.352E-07	-1.252E-03	-1.186E-01
1098	44.6	11.5	29.59	6.352E-07	-1.252E-03	-1.186E-01
1099	44.8	5.5	29.66	3.896E-07	-1.022E-03	-3.475E-01
1100	44.1	( <sup>e</sup> )	29.47	1.440E-07	-7.913E-04	-5.765E-01
1101	43.1	( <sup>e</sup> )	29.15	-1.016E-07	-5.610E-04	-8.055E-01
1102	42.8	10.3	29.03	-1.016E-07	-5.610E-04	-8.055E-01
1103	43	0.7	29.1	-1.016E-07	-5.610E-04	-8.055E-01
1104	42	( <sup>e</sup> )	28.82	-1.016E-07	-5.610E-04	-8.055E-01
1105	41.3	( <sup>e</sup> )	28.60	-1.016E-07	-5.610E-04	-8.055E-01
1106	40.7	( <sup>e</sup> )	28.41	-1.016E-07	-5.610E-04	-8.055E-01
1107	40	1.3	28.19	-1.016E-07	-5.610E-04	-8.055E-01
1108	39.6	6.1	28.07	-1.016E-07	-5.610E-04	-8.055E-01
1109	39.4	2.4	28.01	-1.016E-07	-5.610E-04	-8.055E-01
1110	38.8	( <sup>e</sup> )	27.84	-1.016E-07	-5.610E-04	-8.055E-01
1111	38.1	0.1	27.62	-1.016E-07	-5.610E-04	-8.055E-01
1112	37.4	( <sup>e</sup> )	27.4	-1.016E-07	-5.610E-04	-8.055E-01
1113	36.1	( <sup>e</sup> )	27.01	-1.016E-07	-5.610E-04	-8.055E-01
1114	35	( <sup>e</sup> )	26.68	-1.016E-07	-5.610E-04	-8.055E-01
1115	34	( <sup>e</sup> )	26.35	-1.016E-07	-5.610E-04	-8.055E-01
1116	32.7	( <sup>e</sup> )	25.98	-1.016E-07	-5.610E-04	-8.055E-01
1117	31	( <sup>e</sup> )	25.46	-1.016E-07	-5.610E-04	-8.055E-01
1118	29.8	0.8	25.05	-1.016E-07	-5.610E-04	-8.055E-01
1119	30	8.2	25.12	-1.016E-07	-5.610E-04	-8.055E-01
1120	29.8	1.2	25.07	-1.016E-07	-5.610E-04	-8.055E-01
1121	29.1	( <sup>e</sup> )	24.86	-1.016E-07	-5.610E-04	-8.055E-01
1122	28	( <sup>e</sup> )	24.51	-1.016E-07	-5.610E-04	-8.055E-01
1123	26.8	( <sup>e</sup> )	24.15	-1.016E-07	-5.610E-04	-8.055E-01
1124	25.7	( <sup>e</sup> )	23.82	-1.016E-07	-5.610E-04	-8.055E-01
1125	24	( <sup>e</sup> )	23.3	-1.016E-07	-5.610E-04	-8.055E-01

1126	22.3	(°)	22.79	-1.016E-07	-5.610E-04	-8.055E-01
1127	21.1	(°)	22.39	-1.016E-07	-5.610E-04	-8.055E-01
1128	21	21.6	22.35	-1.016E-07	-5.610E-04	-8.055E-01
1129	22.6	36.9	22.82	-1.016E-07	-5.610E-04	-8.055E-01
1130	24.9	37.1	23.52	-1.016E-07	-5.610E-04	-8.055E-01
1131	26.9	30.8	24.15	-1.016E-07	-5.610E-04	-8.055E-01
1132	28.5	29.6	24.65	-1.016E-07	-5.610E-04	-8.055E-01
1133	29.8	23.4	25.04	-1.016E-07	-5.610E-04	-8.055E-01
1134	30.7	21.9	25.31	-1.016E-07	-5.610E-04	-8.055E-01
1135	31.8	20.3	25.65	-3.387E-08	-1.870E-04	-2.685E-01
1136	32.2	(°)	25.81	3.387E-08	1.870E-04	2.685E-01
1137	30.6	(°)	25.35	1.016E-07	5.610E-04	8.055E-01
1138	27.7	(°)	24.45	1.016E-07	5.610E-04	8.055E-01
1139	24.8	(°)	23.57	1.016E-07	5.610E-04	8.055E-01
1140	22.1	(°)	22.73	1.016E-07	5.610E-04	8.055E-01
1141	20.1	(°)	22.1	1.016E-07	5.610E-04	8.055E-01
1142	18.5	(°)	21.62	1.016E-07	5.610E-04	8.055E-01
1143	21.2	11.1	20.87	1.016E-07	5.610E-04	8.055E-01
1144	36.3	(°)	20.12	1.016E-07	5.610E-04	8.055E-01
1145	33.4	(°)	19.46	1.016E-07	5.610E-04	8.055E-01
1146	30.7	(°)	18.86	1.016E-07	5.610E-04	8.055E-01
1147	27.9	(°)	18.21	1.016E-07	5.610E-04	8.055E-01
1148	24.4	(°)	17.42	1.016E-07	5.610E-04	8.055E-01
1149	21.2	(°)	16.68	1.016E-07	5.610E-04	8.055E-01
1150	17.9	(°)	15.94	1.016E-07	5.610E-04	8.055E-01
1151	38.8	9.1	14.61	1.016E-07	5.610E-04	8.055E-01
1152	20.3	(°)	12.21	1.016E-07	5.610E-04	8.055E-01
1153	15.9	12.7	8.78	1.016E-07	5.610E-04	8.055E-01
1154	12.6	(°)	4.16	1.016E-07	5.610E-04	8.055E-01
1155	0	0	1.53	3.387E-08	1.870E-04	2.685E-01
1156	0	0	0.05	-3.387E-08	-1.870E-04	-2.685E-01
1157	0	0	0	-1.016E-07	-5.610E-04	-8.055E-01
1163	0	0	0	-1.016E-07	-5.610E-04	-8.055E-01
1164	0	0	0	1.960E-06	-2.704E-03	-3.877E-01
1165	2	7.7	0	4.021E-06	-4.848E-03	3.015E-02
1166	8.3	40.4	1.67	6.082E-06	-6.991E-03	4.480E-01
1167	34.3	17.6	3.22	6.082E-06	-6.991E-03	4.480E-01
1168	65.7	16.8	4.4	6.082E-06	-6.991E-03	4.480E-01
1169	35.6	5.8	4.25	6.082E-06	-6.991E-03	4.480E-01
1170	13.2	5.7	3.18	6.082E-06	-6.991E-03	4.480E-01
1171	0	0	2.29	6.082E-06	-6.991E-03	4.480E-01
1172	0	0	1.95	6.082E-06	-6.991E-03	4.480E-01
1173	57.3	38.8	4.02	6.082E-06	-6.991E-03	4.480E-01
1174	59.1	9.7	5.22	6.082E-06	-6.991E-03	4.480E-01
1175	63.4	29.7	5.81	6.082E-06	-6.991E-03	4.480E-01
1176	76	29.9	7.71	6.082E-06	-6.991E-03	4.480E-01
1177	24	4.9	6.89	6.082E-06	-6.991E-03	4.480E-01
1178	42.7	53.3	8.77	6.082E-06	-6.991E-03	4.480E-01
1179	81.2	36.8	12.38	6.082E-06	-6.991E-03	4.480E-01
1180	85.8	(°)	12.88	6.082E-06	-6.991E-03	4.480E-01
1181	50.4	(°)	12.56	6.082E-06	-6.991E-03	4.480E-01
1182	45.6	9.1	12.17	6.082E-06	-6.991E-03	4.480E-01
1183	57.4	46.7	13.57	6.082E-06	-6.991E-03	4.480E-01
1184	77.6	53.7	16.08	6.082E-06	-6.991E-03	4.480E-01
1185	89.2	19.2	17.59	6.082E-06	-6.991E-03	4.480E-01
1186	69.4	15.3	17.8	6.082E-06	-6.991E-03	4.480E-01
1187	56.2	36.1	18.12	6.082E-06	-6.991E-03	4.480E-01
1188	67.1	29.4	19.96	6.082E-06	-6.991E-03	4.480E-01
1189	72.5	36.6	20.86	6.082E-06	-6.991E-03	4.480E-01
1190	45.1	5.9	20.96	6.082E-06	-6.991E-03	4.480E-01
1191	41.1	43.2	21.15	6.082E-06	-6.991E-03	4.480E-01
1192	48.2	57.4	22.73	6.082E-06	-6.991E-03	4.480E-01
1193	53.6	36.3	24	6.082E-06	-6.991E-03	4.480E-01
1194	56.9	28.7	24.76	6.082E-06	-6.991E-03	4.480E-01
1195	58.6	15.2	25.16	6.082E-06	-6.991E-03	4.480E-01
1196	34	4.8	25.14	6.082E-06	-6.991E-03	4.480E-01
1197	28.5	(°)	24.67	6.082E-06	-6.991E-03	4.480E-01
1198	28.6	16.6	24.68	6.082E-06	-6.991E-03	4.480E-01
1199	28.3	2.3	24.6	5.416E-06	-6.524E-03	4.641E-01
1200	29	25.8	24.79	4.750E-06	-6.058E-03	4.802E-01
1201	29.5	20.8	24.95	4.084E-06	-5.591E-03	4.963E-01
1202	30.3	31.8	25.18	4.084E-06	-5.591E-03	4.963E-01

1203	31.7	29.4	25.6	4.084E-06	-5.591E-03	4.963E-01
1204	32.7	26.6	25.94	4.084E-06	-5.591E-03	4.963E-01
1205	33.8	20.6	26.27	4.084E-06	-5.591E-03	4.963E-01
1206	34.1	14.2	26.38	4.084E-06	-5.591E-03	4.963E-01
1207	34.3	8.5	26.45	4.084E-06	-5.591E-03	4.963E-01
1208	34.2	7.6	26.41	4.084E-06	-5.591E-03	4.963E-01
1209	34.2	15.7	26.41	4.084E-06	-5.591E-03	4.963E-01
1210	34.9	17	26.6	4.084E-06	-5.591E-03	4.963E-01
1211	35.2	14.2	26.7	4.084E-06	-5.591E-03	4.963E-01
1212	35.2	13.2	26.7	4.084E-06	-5.591E-03	4.963E-01
1213	35.2	7.2	26.72	1.361E-06	-1.864E-03	1.654E-01
1214	34.9	(°)	26.62	-1.361E-06	1.864E-03	-1.654E-01
1215	33.8	(°)	26.32	-4.084E-06	5.591E-03	-4.963E-01
1216	31.6	(°)	25.65	-4.084E-06	5.591E-03	-4.963E-01
1217	29.2	(°)	24.9	-4.084E-06	5.591E-03	-4.963E-01
1218	26.7	(°)	24.15	-4.084E-06	5.591E-03	-4.963E-01
1219	24.4	(°)	23.44	-4.084E-06	5.591E-03	-4.963E-01
1220	22.1	(°)	22.74	-4.084E-06	5.591E-03	-4.963E-01
1221	20	(°)	22.07	-4.084E-06	5.591E-03	-4.963E-01
1222	17.8	(°)	21.41	-4.084E-06	5.591E-03	-4.963E-01
1223	36.2	16.7	20.77	-4.084E-06	5.591E-03	-4.963E-01
1224	36.2	(°)	20.11	-4.084E-06	5.591E-03	-4.963E-01
1225	32.5	(°)	19.26	-4.084E-06	5.591E-03	-4.963E-01
1226	28.3	(°)	18.3	-4.084E-06	5.591E-03	-4.963E-01
1227	22.2	(°)	16.94	-4.084E-06	5.591E-03	-4.963E-01
1228	25.2	13.9	14.9	-4.084E-06	5.591E-03	-4.963E-01
1229	25.8	2	12.71	-4.084E-06	5.591E-03	-4.963E-01
1230	14.1	(°)	11.12	-4.084E-06	5.591E-03	-4.963E-01
1231	10.6	7.4	10.12	-4.084E-06	5.591E-03	-4.963E-01
1232	20.8	0.2	8.74	-4.084E-06	5.591E-03	-4.963E-01
1233	12.3	(°)	8.03	-4.084E-06	5.591E-03	-4.963E-01
1234	10.5	3.1	7.8	-4.084E-06	5.591E-03	-4.963E-01
1235	12.8	9.3	7.68	-4.084E-06	5.591E-03	-4.963E-01
1236	29.4	3.1	7.48	-1.361E-06	1.864E-03	-1.654E-01
1237	37.4	23.4	8.32	1.361E-06	-1.864E-03	1.654E-01
1238	53.5	32.7	9.8	4.084E-06	-5.591E-03	4.963E-01
1239	77.8	51.3	12.04	4.084E-06	-5.591E-03	4.963E-01
1240	80.8	31	13.87	4.084E-06	-5.591E-03	4.963E-01
1241	29.1	2.8	13.62	4.084E-06	-5.591E-03	4.963E-01
1242	38.6	63.7	15.13	4.084E-06	-5.591E-03	4.963E-01
1243	56.9	37.5	18.23	1.361E-06	-1.864E-03	1.654E-01
1244	58.8	(°)	18.63	-1.361E-06	1.864E-03	-1.654E-01
1245	55.1	(°)	18.02	-4.084E-06	5.591E-03	-4.963E-01
1246	51.3	(°)	17.37	-4.084E-06	5.591E-03	-4.963E-01
1247	47.4	(°)	16.71	-4.084E-06	5.591E-03	-4.963E-01
1248	43.4	(°)	16.04	-4.084E-06	5.591E-03	-4.963E-01
1249	38.5	(°)	15.23	-4.084E-06	5.591E-03	-4.963E-01
1250	30.4	(°)	13.88	-4.084E-06	5.591E-03	-4.963E-01
1251	19.7	(°)	12.09	-4.084E-06	5.591E-03	-4.963E-01
1252	11.8	(°)	10.75	-4.084E-06	5.591E-03	-4.963E-01
1253	29.1	16.9	10.16	-1.361E-06	1.864E-03	-1.654E-01
1254	29.1	4.3	10.12	1.361E-06	-1.864E-03	1.654E-01
1255	34.4	24.4	10.75	4.084E-06	-5.591E-03	4.963E-01
1256	46.4	34.7	12.22	4.084E-06	-5.591E-03	4.963E-01
1257	61.2	45.4	14.05	4.084E-06	-5.591E-03	4.963E-01
1258	79.1	53.2	16.27	4.084E-06	-5.591E-03	4.963E-01
1259	95.4	38.8	17.96	4.084E-06	-5.591E-03	4.963E-01
1260	54.9	2.5	17.77	4.084E-06	-5.591E-03	4.963E-01
1261	56.1	5.8	18.16	4.084E-06	-5.591E-03	4.963E-01
1262	55.1	0.8	18	4.084E-06	-5.591E-03	4.963E-01
1263	53.7	0.4	17.76	4.084E-06	-5.591E-03	4.963E-01
1264	52.2	0.1	17.51	1.361E-06	-1.864E-03	1.654E-01
1265	51.4	4.3	17.37	-1.361E-06	1.864E-03	-1.654E-01
1266	48.8	(°)	16.94	-4.084E-06	5.591E-03	-4.963E-01
1267	44.2	(°)	16.19	-4.084E-06	5.591E-03	-4.963E-01
1268	35.3	(°)	14.72	-4.084E-06	5.591E-03	-4.963E-01
1269	23.4	(°)	12.72	-4.084E-06	5.591E-03	-4.963E-01
1270	11.3	(°)	10.68	-4.084E-06	5.591E-03	-4.963E-01
1271	24.3	5.9	9.21	-4.084E-06	5.591E-03	-4.963E-01
1272	10.1	(°)	7.77	-4.084E-06	5.591E-03	-4.963E-01
1273	20	1.1	6.54	-4.084E-06	5.591E-03	-4.963E-01
1274	17.9	11.7	4.66	-4.084E-06	5.591E-03	-4.963E-01

1275	6.3	0.7	2.8	-1.361E-06	1.864E-03	-1.654E-01
1276	9.6	23.3	3.12	1.361E-06	-1.864E-03	1.654E-01
1277	33.1	16.3	4.31	4.084E-06	-5.591E-03	4.963E-01
1278	58.7	18.9	5.6	4.084E-06	-5.591E-03	4.963E-01
1279	87.6	26.5	6.99	4.084E-06	-5.591E-03	4.963E-01
1280	48.5	1.8	6.84	4.084E-06	-5.591E-03	4.963E-01
1281	74.4	41.3	8.63	4.084E-06	-5.591E-03	4.963E-01
1282	64.1	12.5	9.83	4.084E-06	-5.591E-03	4.963E-01
1283	57.1	34.6	10.14	4.084E-06	-5.591E-03	4.963E-01
1284	91	78.4	13.22	4.084E-06	-5.591E-03	4.963E-01
1285	38.6	8.5	13.95	4.084E-06	-5.591E-03	4.963E-01
1286	32.8	40	14.2	4.084E-06	-5.591E-03	4.963E-01
1287	47	74.3	16.52	4.084E-06	-5.591E-03	4.963E-01
1288	64.2	53.9	19.43	4.084E-06	-5.591E-03	4.963E-01
1289	70.4	21.4	20.54	4.084E-06	-5.591E-03	4.963E-01
1290	71.9	7.4	20.81	4.084E-06	-5.591E-03	4.963E-01
1291	39.8	2.4	20.61	4.084E-06	-5.591E-03	4.963E-01
1292	39.6	32	20.81	4.084E-06	-5.591E-03	4.963E-01
1293	42.7	24	21.52	4.084E-06	-5.591E-03	4.963E-01
1294	44.6	20.6	21.98	4.084E-06	-5.591E-03	4.963E-01
1295	47.3	31.6	22.58	4.084E-06	-5.591E-03	4.963E-01
1296	49.9	22.2	23.18	4.084E-06	-5.591E-03	4.963E-01
1297	50.7	9.1	23.38	4.084E-06	-5.591E-03	4.963E-01
1298	50.1	0.8	23.24	4.084E-06	-5.591E-03	4.963E-01
1299	49.4	4.5	23.08	4.084E-06	-5.591E-03	4.963E-01
1300	48	(°)	22.79	1.361E-06	-1.864E-03	1.654E-01
1301	46.9	1.9	22.53	-1.361E-06	1.864E-03	-1.654E-01
1302	45.9	0	22.29	-4.084E-06	5.591E-03	-4.963E-01
1303	44.2	(°)	21.93	-4.084E-06	5.591E-03	-4.963E-01
1304	42.2	(°)	21.47	-4.084E-06	5.591E-03	-4.963E-01
1305	39.1	(°)	20.77	-4.084E-06	5.591E-03	-4.963E-01
1306	33.2	(°)	19.45	-4.084E-06	5.591E-03	-4.963E-01
1307	25.5	(°)	17.72	-4.084E-06	5.591E-03	-4.963E-01
1308	16	3.5	15.24	-4.084E-06	5.591E-03	-4.963E-01
1309	27.1	(°)	12.8	-4.084E-06	5.591E-03	-4.963E-01
1310	8.7	(°)	10.26	-4.084E-06	5.591E-03	-4.963E-01
1311	11.4	5.9	7.19	-4.084E-06	5.591E-03	-4.963E-01
1312	13.8	6.7	5.46	-4.084E-06	5.591E-03	-4.963E-01
1313	14.3	(°)	4.52	-4.084E-06	5.591E-03	-4.963E-01
1314	30	14.9	4.17	-1.361E-06	1.864E-03	-1.654E-01
1315	27.8	0.3	4.06	1.361E-06	-1.864E-03	1.654E-01
1316	41.8	16.8	4.74	4.084E-06	-5.591E-03	4.963E-01
1317	68.8	20.7	6.11	4.084E-06	-5.591E-03	4.963E-01
1318	65.3	16.6	6.88	4.084E-06	-5.591E-03	4.963E-01
1319	50.9	30.1	7.04	4.084E-06	-5.591E-03	4.963E-01
1320	71.4	14.2	8.48	4.084E-06	-5.591E-03	4.963E-01
1321	65.7	16.8	8.79	4.084E-06	-5.591E-03	4.963E-01
1322	41.5	12.7	8.72	4.084E-06	-5.591E-03	4.963E-01
1323	45.3	9	9.08	1.361E-06	-1.864E-03	1.654E-01
1324	47	(°)	9.26	-1.361E-06	1.864E-03	-1.654E-01
1325	41.1	(°)	8.71	-4.084E-06	5.591E-03	-4.963E-01
1326	34.1	(°)	8.06	-4.084E-06	5.591E-03	-4.963E-01
1327	23.5	(°)	7.08	-4.084E-06	5.591E-03	-4.963E-01
1328	8.1	1.2	5.51	-4.084E-06	5.591E-03	-4.963E-01
1329	19.1	9.4	3.49	-4.084E-06	5.591E-03	-4.963E-01
1330	0	0	2.56	-4.084E-06	5.591E-03	-4.963E-01
1331	0.9	7.7	2.34	-1.361E-06	1.864E-03	-1.654E-01
1332	0.7	3.4	2.53	1.361E-06	-1.864E-03	1.654E-01
1333	0	0	2.45	4.084E-06	-5.591E-03	4.963E-01
1334	7.5	17.5	3.02	4.084E-06	-5.591E-03	4.963E-01
1335	22.4	12	3.77	4.084E-06	-5.591E-03	4.963E-01
1336	36	10.8	4.46	4.084E-06	-5.591E-03	4.963E-01
1337	48.2	6.5	5.09	1.361E-06	-1.864E-03	1.654E-01
1338	48	0.2	5.09	-1.361E-06	1.864E-03	-1.654E-01
1339	39.2	(°)	4.65	-4.084E-06	5.591E-03	-4.963E-01
1340	27.4	(°)	4.05	-4.084E-06	5.591E-03	-4.963E-01
1341	15.9	(°)	3.46	-4.084E-06	5.591E-03	-4.963E-01
1342	2	0.2	2.89	-4.084E-06	5.591E-03	-4.963E-01
1343	0.1	3.8	1.88	-4.084E-06	5.591E-03	-4.963E-01
1344	0	0	1.24	-4.084E-06	5.591E-03	-4.963E-01
1345	0	0	0	-4.084E-06	5.591E-03	-4.963E-01
1349	0	0	0	-4.084E-06	5.591E-03	-4.963E-01



1350	0	0	0	2.872E-07	7.170E-04	1.226E-01
1351	0	0	0	4.658E-06	-4.157E-03	7.415E-01
1352	1.1	6.8	0.02	9.029E-06	-9.032E-03	1.360E+00
1353	6.1	21.6	0.65	9.029E-06	-9.032E-03	1.360E+00
1354	6.4	18.5	1.96	9.029E-06	-9.032E-03	1.360E+00
1355	17.4	10.1	2.61	9.029E-06	-9.032E-03	1.360E+00
1356	30.9	7.8	3.11	9.029E-06	-9.032E-03	1.360E+00
1357	44.5	8.4	3.62	9.029E-06	-9.032E-03	1.360E+00
1358	61.1	10.5	4.24	9.029E-06	-9.032E-03	1.360E+00
1359	35.1	0.4	4.33	9.029E-06	-9.032E-03	1.360E+00
1360	52.5	23.7	5.27	9.029E-06	-9.032E-03	1.360E+00
1361	83.5	20.9	6.86	9.029E-06	-9.032E-03	1.360E+00
1362	50.3	0.8	6.89	9.029E-06	-9.032E-03	1.360E+00
1363	68	37.5	8.2	9.029E-06	-9.032E-03	1.360E+00
1364	85.5	25.2	9.88	9.029E-06	-9.032E-03	1.360E+00
1365	52.7	8.2	9.77	9.029E-06	-9.032E-03	1.360E+00
1366	73.4	39.6	11.65	9.029E-06	-9.032E-03	1.360E+00
1367	89.5	27.4	13.24	9.029E-06	-9.032E-03	1.360E+00
1368	53	6	13.1	9.029E-06	-9.032E-03	1.360E+00
1369	63.6	11.9	14.41	9.029E-06	-9.032E-03	1.360E+00
1370	65.6	12.2	14.65	7.296E-06	-7.440E-03	1.057E+00
1371	37.4	1	14.67	5.562E-06	-5.849E-03	7.534E-01
1372	38.7	40	15.19	3.829E-06	-4.257E-03	4.499E-01
1373	45.5	24.5	16.35	3.829E-06	-4.257E-03	4.499E-01
1374	49	17.2	16.95	3.829E-06	-4.257E-03	4.499E-01
1375	51.4	13.6	17.35	3.829E-06	-4.257E-03	4.499E-01
1376	52.5	7.2	17.56	3.829E-06	-4.257E-03	4.499E-01
1377	51.4	(°)	17.38	3.829E-06	-4.257E-03	4.499E-01
1378	48.9	(°)	16.96	3.829E-06	-4.257E-03	4.499E-01
1379	45.8	(°)	16.44	3.829E-06	-4.257E-03	4.499E-01
1380	42.4	(°)	15.88	3.829E-06	-4.257E-03	4.499E-01
1381	38.5	(°)	15.23	3.829E-06	-4.257E-03	4.499E-01
1382	38.6	11.6	15.22	3.829E-06	-4.257E-03	4.499E-01
1383	39.9	6.5	15.44	1.276E-06	-1.419E-03	1.500E-01
1384	39.3	2	15.34	-1.276E-06	1.419E-03	-1.500E-01
1385	37.9	(°)	15.12	-3.829E-06	4.257E-03	-4.499E-01
1386	35.1	(°)	14.65	-3.829E-06	4.257E-03	-4.499E-01
1387	32.2	(°)	14.16	-3.829E-06	4.257E-03	-4.499E-01
1388	27.3	(°)	13.35	-3.829E-06	4.257E-03	-4.499E-01
1389	18.7	(°)	11.92	-3.829E-06	4.257E-03	-4.499E-01
1390	10.4	8.1	9.91	-3.829E-06	4.257E-03	-4.499E-01
1391	14.8	4.6	7.88	-3.829E-06	4.257E-03	-4.499E-01
1392	13.2	3.6	5.88	-3.829E-06	4.257E-03	-4.499E-01
1393	13.6	8.9	3.69	-3.829E-06	4.257E-03	-4.499E-01
1394	0	0	2.44	-5.773E-06	6.214E-03	-9.832E-01
1395	0	0	2.26	-7.717E-06	8.171E-03	-1.516E+00
1396	0.5	9.5	2.01	-3.221E-06	3.376E-03	-6.833E-01
1397	5.4	7.1	1.94	3.221E-06	-3.376E-03	6.833E-01
1398	8.2	9	2.27	9.662E-06	-1.013E-02	2.050E+00
1399	21.2	10.3	2.74	9.662E-06	-1.013E-02	2.050E+00
1400	43.7	13.1	3.58	9.662E-06	-1.013E-02	2.050E+00
1401	68.2	16.2	4.51	9.662E-06	-1.013E-02	2.050E+00
1402	35.2	2	4.36	9.662E-06	-1.013E-02	2.050E+00
1403	67.5	31.5	6.02	9.662E-06	-1.013E-02	2.050E+00
1404	78.2	22.2	7.27	9.662E-06	-1.013E-02	2.050E+00
1405	54	18.5	7.27	9.662E-06	-1.013E-02	2.050E+00
1406	89.3	35.3	9.67	9.662E-06	-1.013E-02	2.050E+00
1407	54.6	0.9	9.76	9.662E-06	-1.013E-02	2.050E+00
1408	64.4	29.5	10.83	9.662E-06	-1.013E-02	2.050E+00
1409	77.2	23.7	12.04	9.662E-06	-1.013E-02	2.050E+00
1410	49	2.1	12.27	9.662E-06	-1.013E-02	2.050E+00
1411	52.1	40.4	12.93	9.662E-06	-1.013E-02	2.050E+00
1412	63.3	18.4	14.36	9.662E-06	-1.013E-02	2.050E+00
1413	62.3	(°)	14.27	9.662E-06	-1.013E-02	2.050E+00
1414	29.7	(°)	13.64	9.662E-06	-1.013E-02	2.050E+00
1415	24.2	(°)	12.82	9.662E-06	-1.013E-02	2.050E+00
1416	18.8	(°)	11.92	9.662E-06	-1.013E-02	2.050E+00
1417	14.1	(°)	11.12	9.662E-06	-1.013E-02	2.050E+00
1418	10.5	(°)	10.5	8.531E-06	-9.269E-03	1.714E+00
1419	11.3	25.6	10.63	7.400E-06	-8.410E-03	1.379E+00
1420	14.9	15.2	11.24	6.269E-06	-7.552E-03	1.044E+00
1421	12.8	(°)	10.9	6.269E-06	-7.552E-03	1.044E+00

1422	25	9.3	9.25	6.269E-06	-7.552E-03	1.044E+00
1423	18.6	9.1	8.81	6.269E-06	-7.552E-03	1.044E+00
1424	24.5	24.4	9.52	6.269E-06	-7.552E-03	1.044E+00
1425	32.7	24.2	10.54	6.269E-06	-7.552E-03	1.044E+00
1426	41.1	24.4	11.59	6.269E-06	-7.552E-03	1.044E+00
1427	50	26	12.69	6.269E-06	-7.552E-03	1.044E+00
1428	58.6	18.7	13.77	6.269E-06	-7.552E-03	1.044E+00
1429	64	25.5	14.44	6.269E-06	-7.552E-03	1.044E+00
1430	37.7	1.4	14.67	6.269E-06	-7.552E-03	1.044E+00
1431	38.4	30.5	15.15	2.090E-06	-2.517E-03	3.478E-01
1432	39.3	(°)	15.34	-2.090E-06	2.517E-03	-3.478E-01
1433	36.4	(°)	14.86	-6.269E-06	7.552E-03	-1.044E+00
1434	33.4	(°)	14.36	-6.269E-06	7.552E-03	-1.044E+00
1435	29.7	(°)	13.74	-6.269E-06	7.552E-03	-1.044E+00
1436	25.8	(°)	13.08	-6.269E-06	7.552E-03	-1.044E+00
1437	21.3	(°)	12.34	-6.269E-06	7.552E-03	-1.044E+00
1438	17.5	(°)	11.69	-6.269E-06	7.552E-03	-1.044E+00
1439	15.1	1.2	11.28	-6.269E-06	7.552E-03	-1.044E+00
1440	14.3	2.3	11.14	-6.269E-06	7.552E-03	-1.044E+00
1441	12.6	(°)	10.86	-6.269E-06	7.552E-03	-1.044E+00
1442	9.9	(°)	10.42	-6.269E-06	7.552E-03	-1.044E+00
1443	27.4	13.6	9.89	-6.269E-06	7.552E-03	-1.044E+00
1444	23	(°)	9.37	-6.269E-06	7.552E-03	-1.044E+00
1445	20.8	3.5	9.09	-6.269E-06	7.552E-03	-1.044E+00
1446	20.5	5.3	9.05	-6.269E-06	7.552E-03	-1.044E+00
1447	18.5	(°)	8.8	-6.269E-06	7.552E-03	-1.044E+00
1448	11.9	(°)	8	-6.269E-06	7.552E-03	-1.044E+00
1449	22.4	6.1	6.71	-6.269E-06	7.552E-03	-1.044E+00
1450	10	8.7	5.21	-6.269E-06	7.552E-03	-1.044E+00
1451	6.7	0.6	2.72	-6.269E-06	7.552E-03	-1.044E+00
1452	0	0	0.95	-6.269E-06	7.552E-03	-1.044E+00
1453	0	0	0	-6.269E-06	7.552E-03	-1.044E+00
1454	0	0	0	-6.269E-06	7.552E-03	-1.044E+00
1455	0	0	0	-1.593E-06	2.190E-03	-8.036E-01
1456	0	0	0	3.083E-06	-3.171E-03	-5.636E-01
1457	0	0	0	7.759E-06	-8.533E-03	-3.236E-01
1518	0	0	0	7.759E-06	-8.533E-03	-3.236E-01
1519	5.1	15	0.14	7.759E-06	-8.533E-03	-3.236E-01
1520	7	25.8	1.71	7.759E-06	-8.533E-03	-3.236E-01
1521	18.1	9.5	2.64	7.759E-06	-8.533E-03	-3.236E-01
1522	28.4	7.1	3.02	7.759E-06	-8.533E-03	-3.236E-01
1523	44.9	9.8	3.64	7.759E-06	-8.533E-03	-3.236E-01
1524	57.8	6.7	4.13	7.759E-06	-8.533E-03	-3.236E-01
1525	33.6	4.5	4.17	7.759E-06	-8.533E-03	-3.236E-01
1526	37.9	12.1	4.56	7.759E-06	-8.533E-03	-3.236E-01
1527	48.5	6.2	5.11	2.586E-06	-2.844E-03	-1.079E-01
1528	49.9	1.3	5.19	-2.586E-06	2.844E-03	1.079E-01
1529	42.5	(°)	4.82	-7.759E-06	8.533E-03	3.236E-01
1530	30.4	(°)	4.2	-7.759E-06	8.533E-03	3.236E-01
1531	18.7	(°)	3.61	-7.759E-06	8.533E-03	3.236E-01
1532	4	0.9	2.85	-7.759E-06	8.533E-03	3.236E-01
1533	0.1	3.9	1.94	-7.759E-06	8.533E-03	3.236E-01
1534	0	0	1.16	-2.586E-06	2.844E-03	1.079E-01
1535	0	0	0	2.586E-06	-2.844E-03	-1.079E-01
1536	0	0	0	7.759E-06	-8.533E-03	-3.236E-01
1560	0	0	0	7.759E-06	-8.533E-03	-3.236E-01
1561	3	5	0	7.759E-06	-8.533E-03	-3.236E-01
1562	7	10	0	7.759E-06	-8.533E-03	-3.236E-01
1563	4.7	8.1	0.62	7.759E-06	-8.533E-03	-3.236E-01
1564	2	6.4	1.04	7.759E-06	-8.533E-03	-3.236E-01
1565	6.2	11.6	1.54	7.759E-06	-8.533E-03	-3.236E-01
1566	8.6	8.9	2.49	7.759E-06	-8.533E-03	-3.236E-01
1567	20.7	5.2	2.98	7.759E-06	-8.533E-03	-3.236E-01
1568	28	1.9	3.28	2.586E-06	-2.844E-03	-1.079E-01
1569	25.6	(°)	3.19	-2.586E-06	2.844E-03	1.079E-01
1570	14.9	(°)	2.75	-7.759E-06	8.533E-03	3.236E-01
1571	0	0	1.3	-2.586E-06	2.844E-03	1.079E-01
1572	0	0	0	2.586E-06	-2.844E-03	-1.079E-01
1573	1.2	6.5	0.05	7.759E-06	-8.533E-03	-3.236E-01
1574	6.8	23.2	1.12	7.759E-06	-8.533E-03	-3.236E-01
1575	16.6	14.1	2.81	7.759E-06	-8.533E-03	-3.236E-01
1576	52.5	14.5	4.24	7.759E-06	-8.533E-03	-3.236E-01

1577	76.9	22.6	5.6	7.759E-06	-8.533E-03	-3.236E-01
1578	52.1	12.3	5.96	7.759E-06	-8.533E-03	-3.236E-01
1579	94.5	27.6	8.32	7.759E-06	-8.533E-03	-3.236E-01
1580	56.4	1	8.63	7.759E-06	-8.533E-03	-3.236E-01
1581	66	5.3	9.37	2.586E-06	-2.844E-03	-1.079E-01
1582	49.2	6.7	9.62	-2.586E-06	2.844E-03	1.079E-01
1583	31.3	( <sup>e</sup> )	9.11	-7.759E-06	8.533E-03	3.236E-01
1584	22.1	( <sup>e</sup> )	8.11	-7.759E-06	8.533E-03	3.236E-01
1585	12.1	( <sup>e</sup> )	7.01	-7.759E-06	8.533E-03	3.236E-01
1586	27.3	8.2	6.04	-7.759E-06	8.533E-03	3.236E-01
1587	16	( <sup>e</sup> )	5.42	-2.586E-06	2.844E-03	1.079E-01
1588	17.4	10.5	5.5	2.586E-06	-2.844E-03	-1.079E-01
1589	33.7	15.4	6.79	7.759E-06	-8.533E-03	-3.236E-01
1590	43.6	( <sup>e</sup> )	7.61	7.759E-06	-8.533E-03	-3.236E-01
1591	37.7	( <sup>e</sup> )	7.15	7.759E-06	-8.533E-03	-3.236E-01
1592	34.8	6.5	6.89	7.759E-06	-8.533E-03	-3.236E-01
1593	60.7	30.4	8.88	7.759E-06	-8.533E-03	-3.236E-01
1594	90.6	21.4	11.28	7.759E-06	-8.533E-03	-3.236E-01
1595	54.9	( <sup>e</sup> )	11.48	7.759E-06	-8.533E-03	-3.236E-01
1596	48.4	( <sup>e</sup> )	10.97	7.759E-06	-8.533E-03	-3.236E-01
1597	56.5	19.6	11.78	7.759E-06	-8.533E-03	-3.236E-01
1598	72	21.8	13.47	7.759E-06	-8.533E-03	-3.236E-01
1599	85.8	26.9	14.92	7.759E-06	-8.533E-03	-3.236E-01
1600	32.2	2.2	15.21	7.759E-06	-8.533E-03	-3.236E-01
1601	42.2	31.8	17.03	7.759E-06	-8.533E-03	-3.236E-01
1602	46.5	1.9	17.89	7.759E-06	-8.533E-03	-3.236E-01
1603	57.8	21.7	19.09	2.586E-06	-2.844E-03	-1.079E-01
1604	37.1	4.8	19.37	-2.586E-06	2.844E-03	1.079E-01
1605	36.7	( <sup>e</sup> )	19.31	-7.759E-06	8.533E-03	3.236E-01
1606	32.8	( <sup>e</sup> )	18.5	-7.759E-06	8.533E-03	3.236E-01
1607	27.8	( <sup>e</sup> )	17.4	-7.759E-06	8.533E-03	3.236E-01
1608	22.8	( <sup>e</sup> )	16.33	-7.759E-06	8.533E-03	3.236E-01
1609	16.5	( <sup>e</sup> )	14.97	-7.759E-06	8.533E-03	3.236E-01
1610	10.3	7.6	12.74	-7.759E-06	8.533E-03	3.236E-01
1611	12.8	6.4	10.27	-7.759E-06	8.533E-03	3.236E-01
1612	30.4	11.4	8.67	-7.759E-06	8.533E-03	3.236E-01
1613	12.4	( <sup>e</sup> )	7.07	-7.992E-06	8.661E-03	1.236E+00
1614	0	0	4.45	-8.224E-06	8.788E-03	2.148E+00
1615	1.1	1.4	3.71	-2.819E-06	2.972E-03	1.020E+00
1616	43.1	4.2	5.47	2.819E-06	-2.972E-03	-1.020E+00
1617	54.9	6.5	6.15	8.457E-06	-8.916E-03	-3.061E+00
1618	74.6	17.4	7.24	8.457E-06	-8.916E-03	-3.061E+00
1619	52.3	1.4	8.08	8.457E-06	-8.916E-03	-3.061E+00
1620	67.1	23.5	9.41	8.457E-06	-8.916E-03	-3.061E+00
1621	79.1	1.9	10.43	2.819E-06	-2.972E-03	-1.020E+00
1622	46.4	( <sup>e</sup> )	10.52	-2.819E-06	2.972E-03	1.020E+00
1623	39	( <sup>e</sup> )	9.95	-8.457E-06	8.916E-03	3.061E+00
1624	28.8	( <sup>e</sup> )	8.85	-8.457E-06	8.916E-03	3.061E+00
1625	16.6	( <sup>e</sup> )	7.52	-8.457E-06	8.916E-03	3.061E+00
1626	20.1	14.2	6.17	-8.457E-06	8.916E-03	3.061E+00
1627	15.4	( <sup>e</sup> )	5.37	-2.819E-06	2.972E-03	1.020E+00
1628	17.1	10.6	5.48	2.819E-06	-2.972E-03	-1.020E+00
1629	40.8	26.5	7.31	8.457E-06	-8.916E-03	-3.061E+00
1630	69.8	18.3	9.64	8.457E-06	-8.916E-03	-3.061E+00
1631	85.7	13.1	10.91	8.457E-06	-8.916E-03	-3.061E+00
1632	51.9	1.7	11.25	8.457E-06	-8.916E-03	-3.061E+00
1633	72.1	42.7	13.42	8.457E-06	-8.916E-03	-3.061E+00
1634	84.4	29.2	15.77	8.457E-06	-8.916E-03	-3.061E+00
1635	35.6	( <sup>e</sup> )	15.91	8.457E-06	-8.916E-03	-3.061E+00
1636	40.5	30.3	16.73	8.457E-06	-8.916E-03	-3.061E+00
1637	52.7	44.5	18.91	8.457E-06	-8.916E-03	-3.061E+00
1638	65.4	19.1	21.27	2.819E-06	-2.972E-03	-1.020E+00
1639	67.1	( <sup>e</sup> )	21.64	-2.819E-06	2.972E-03	1.020E+00
1640	34	( <sup>e</sup> )	21.56	-8.457E-06	8.916E-03	3.061E+00
1641	31.3	( <sup>e</sup> )	21.28	-8.457E-06	8.916E-03	3.061E+00
1642	29.3	( <sup>e</sup> )	20.79	-8.457E-06	8.916E-03	3.061E+00
1643	25.4	( <sup>e</sup> )	19.83	-8.457E-06	8.916E-03	3.061E+00
1644	19.9	( <sup>e</sup> )	18.43	-8.457E-06	8.916E-03	3.061E+00
1645	23	5.7	16.06	-8.457E-06	8.916E-03	3.061E+00
1646	8.9	5.7	12.52	-8.457E-06	8.916E-03	3.061E+00
1647	12.4	7.5	8.98	-8.457E-06	8.916E-03	3.061E+00
1648	16.5	2.7	7.22	-8.457E-06	8.916E-03	3.061E+00

1649	25	10.8	5.92	-8.457E-06	8.916E-03	3.061E+00
1650	16.3	4.1	5.43	-2.819E-06	2.972E-03	1.020E+00
1651	41.5	28.9	7.37	2.819E-06	-2.972E-03	-1.020E+00
1652	82.3	43.6	10.55	8.457E-06	-8.916E-03	-3.061E+00
1653	56.9	0.2	11.66	8.457E-06	-8.916E-03	-3.061E+00
1654	70.1	45.2	13.2	8.457E-06	-8.916E-03	-3.061E+00
1655	72.7	29.1	15.78	8.457E-06	-8.916E-03	-3.061E+00
1656	36.9	16.9	16.11	8.457E-06	-8.916E-03	-3.061E+00
1657	42.7	(°)	17.2	2.819E-06	-2.972E-03	-1.020E+00
1658	41.3	(°)	16.96	-2.819E-06	2.972E-03	1.020E+00
1659	37.7	(°)	16.32	-8.457E-06	8.916E-03	3.061E+00
1660	34.5	(°)	15.73	-8.457E-06	8.916E-03	3.061E+00
1661	27	(°)	14.41	-8.457E-06	8.916E-03	3.061E+00
1662	15	(°)	12.23	-8.457E-06	8.916E-03	3.061E+00
1663	11.6	0.1	9.56	-8.457E-06	8.916E-03	3.061E+00
1664	10	(°)	6.48	-8.457E-06	8.916E-03	3.061E+00
1665	15.6	9.8	3.7	-8.457E-06	8.916E-03	3.061E+00
1666	0	0	0.19	-8.457E-06	8.916E-03	3.061E+00
1667	0	0	0	-8.457E-06	8.916E-03	3.061E+00
1668	0	0	0	1.191E-06	-1.811E-04	2.220E+00
1669	0	0	0	1.084E-05	-9.278E-03	1.379E+00
1670	0	0	0	2.049E-05	-1.837E-02	5.378E-01
1678	0	0	0	2.049E-05	-1.837E-02	5.378E-01
1679	1.4	7.2	0.05	2.049E-05	-1.837E-02	5.378E-01
1680	6.6	22.6	0.85	2.049E-05	-1.837E-02	5.378E-01
1681	16.2	15.4	2.8	2.049E-05	-1.837E-02	5.378E-01
1682	59.1	19.5	4.49	2.049E-05	-1.837E-02	5.378E-01
1683	67.4	17.1	5.91	2.049E-05	-1.837E-02	5.378E-01
1684	62.3	17.7	6.54	2.049E-05	-1.837E-02	5.378E-01
1685	77.8	11.5	7.55	2.049E-05	-1.837E-02	5.378E-01
1686	41.8	(°)	7.48	2.049E-05	-1.837E-02	5.378E-01
1687	35.9	(°)	7	2.049E-05	-1.837E-02	5.378E-01
1688	39.3	0.2	7.27	6.829E-06	-6.125E-03	1.793E-01
1689	34.3	(°)	6.88	-6.829E-06	6.125E-03	-1.793E-01
1690	9.5	3.5	4.95	-6.829E-06	6.125E-03	-1.793E-01
1691	0	0	0	6.829E-06	-6.125E-03	1.793E-01
1692	0	0	0	2.049E-05	-1.837E-02	5.378E-01
1693	0	0	0	2.049E-05	-1.837E-02	5.378E-01
1694	0.5	6.5	0.15	2.049E-05	-1.837E-02	5.378E-01
1695	3.6	6.9	0.57	2.049E-05	-1.837E-02	5.378E-01
1696	5.4	9.3	1.14	2.049E-05	-1.837E-02	5.378E-01
1697	5.5	6.2	1.71	2.049E-05	-1.837E-02	5.378E-01
1698	3.1	3.5	2.03	2.049E-05	-1.837E-02	5.378E-01
1699	0	0	2.12	2.049E-05	-1.837E-02	5.378E-01
1700	0	0	1.59	2.049E-05	-1.837E-02	5.378E-01
1701	0	0	0	2.049E-05	-1.837E-02	5.378E-01
1702	3.1	7.4	0.27	2.049E-05	-1.837E-02	5.378E-01
1703	6.8	20.3	1.79	2.049E-05	-1.837E-02	5.378E-01
1704	24.6	12.8	3.14	2.049E-05	-1.837E-02	5.378E-01
1705	64.5	18.2	4.72	2.049E-05	-1.837E-02	5.378E-01
1706	53.8	7.7	5.69	2.049E-05	-1.837E-02	5.378E-01
1707	66.6	27.9	6.75	2.049E-05	-1.837E-02	5.378E-01
1708	72.2	18.5	8.42	2.049E-05	-1.837E-02	5.378E-01
1709	63.5	31.1	9.1	2.049E-05	-1.837E-02	5.378E-01
1710	94.7	29.7	11.46	2.049E-05	-1.837E-02	5.378E-01
1711	55.9	2.1	11.77	2.049E-05	-1.837E-02	5.378E-01
1712	82.9	60.8	14.55	2.049E-05	-1.837E-02	5.378E-01
1713	39.6	4.9	15.87	6.829E-06	-6.125E-03	1.793E-01
1714	38.7	4.2	16.46	-6.829E-06	6.125E-03	-1.793E-01
1715	37.4	(°)	16.26	-2.049E-05	1.837E-02	-5.378E-01
1716	32.9	(°)	15.46	-2.049E-05	1.837E-02	-5.378E-01
1717	27.7	(°)	14.51	-2.049E-05	1.837E-02	-5.378E-01
1718	23.1	(°)	13.67	-2.049E-05	1.837E-02	-5.378E-01
1719	17.1	(°)	12.6	-2.049E-05	1.837E-02	-5.378E-01
1720	9.1	6.4	10.02	-1.891E-05	1.685E-02	4.276E-01
1721	10.6	3	6.37	-6.829E-06	6.125E-03	-1.793E-01
1722	37.5	15.4	7.09	5.248E-06	-4.601E-03	-7.862E-01
1723	73.5	38.4	9.87	1.574E-05	-1.380E-02	-2.358E+00
1724	87.7	20.1	11.51	1.574E-05	-1.380E-02	-2.358E+00
1725	56.6	5.6	11.83	1.574E-05	-1.380E-02	-2.358E+00
1726	85.3	41.3	14.86	1.574E-05	-1.380E-02	-2.358E+00
1727	41.9	7.1	15.88	1.574E-05	-1.380E-02	-2.358E+00

1728	40.7	38.8	16.75	1.574E-05	-1.380E-02	-2.358E+00
1729	51.4	13	18.75	1.574E-05	-1.380E-02	-2.358E+00
1730	51.6	(°)	18.82	1.574E-05	-1.380E-02	-2.358E+00
1731	33.9	(°)	18.77	1.574E-05	-1.380E-02	-2.358E+00
1732	34	(°)	18.71	1.574E-05	-1.380E-02	-2.358E+00
1733	35	1.8	18.92	1.574E-05	-1.380E-02	-2.358E+00
1734	35.6	(°)	19.07	5.248E-06	-4.601E-03	-7.862E-01
1735	33.9	(°)	18.71	-5.248E-06	4.601E-03	7.862E-01
1736	30.3	(°)	17.95	-1.574E-05	1.380E-02	2.358E+00
1737	25.8	(°)	16.97	-1.574E-05	1.380E-02	2.358E+00
1738	21	(°)	15.93	-1.574E-05	1.380E-02	2.358E+00
1739	16.3	(°)	14.9	-1.574E-05	1.380E-02	2.358E+00
1740	11.5	(°)	13.86	-1.574E-05	1.380E-02	2.358E+00
1741	18.5	5.5	12.45	-1.722E-05	1.520E-02	1.428E+00
1742	12.4	8.2	10.28	-1.870E-05	1.660E-02	4.983E-01
1743	24.2	7.3	7.92	-2.018E-05	1.800E-02	-4.318E-01
1744	17	6.9	5.23	-2.018E-05	1.800E-02	-4.318E-01
1745	21.2	11.5	4.36	-6.726E-06	6.000E-03	-1.439E-01
1746	52.4	26	5.94	6.726E-06	-6.000E-03	1.439E-01
1747	89.6	29.8	8.35	2.018E-05	-1.800E-02	4.318E-01
1748	57.8	11.2	8.7	2.018E-05	-1.800E-02	4.318E-01
1749	97.7	41.2	11.46	2.018E-05	-1.800E-02	4.318E-01
1750	55.9	(°)	11.77	2.018E-05	-1.800E-02	4.318E-01
1751	80.7	31.1	14.39	2.018E-05	-1.800E-02	4.318E-01
1752	71.6	28.9	15.8	2.018E-05	-1.800E-02	4.318E-01
1753	37	17	16.13	2.018E-05	-1.800E-02	4.318E-01
1754	41.1	7.7	16.88	2.018E-05	-1.800E-02	4.318E-01
1755	44.3	7.3	17.47	2.018E-05	-1.800E-02	4.318E-01
1756	46.7	(°)	17.93	2.018E-05	-1.800E-02	4.318E-01
1757	30.6	(°)	17.61	2.018E-05	-1.800E-02	4.318E-01
1758	24.8	(°)	16.74	2.018E-05	-1.800E-02	4.318E-01
1759	21.2	(°)	15.93	2.018E-05	-1.800E-02	4.318E-01
1760	21.2	4.1	15.91	2.018E-05	-1.800E-02	4.318E-01
1761	23.4	2.4	16.39	6.726E-06	-6.000E-03	1.439E-01
1762	23.4	(°)	16.42	-6.726E-06	6.000E-03	-1.439E-01
1763	19.7	(°)	15.63	-2.018E-05	1.800E-02	-4.318E-01
1764	13.8	(°)	14.36	-2.018E-05	1.800E-02	-4.318E-01
1765	12.6	9.7	12.98	-2.018E-05	1.800E-02	-4.318E-01
1766	12.5	(°)	11.75	-2.018E-05	1.800E-02	-4.318E-01
1767	15.5	10.3	10.96	-2.018E-05	1.800E-02	-4.318E-01
1768	12.4	(°)	9.99	-2.018E-05	1.800E-02	-4.318E-01
1769	23.1	7.5	7.76	-2.018E-05	1.800E-02	-4.318E-01
1770	20.1	7.4	5.51	-2.018E-05	1.800E-02	-4.318E-01
1771	17.8	5.9	3.84	-6.726E-06	6.000E-03	-1.439E-01
1772	0	0	2.83	-3.978E-06	4.119E-04	-8.900E-02
1773	0.3	4.2	2.6	-1.229E-06	-5.176E-03	-3.405E-02
1774	4.6	13.8	3.25	-1.193E-05	1.236E-03	-2.670E-01
1775	30.1	18.8	4.69	-1.193E-05	1.236E-03	-2.670E-01
1776	65.5	20.4	6.71	-1.193E-05	1.236E-03	-2.670E-01
1777	82.3	18	8.02	-1.193E-05	1.236E-03	-2.670E-01
1778	49	(°)	8.05	-1.193E-05	1.236E-03	-2.670E-01
1779	42.4	(°)	7.53	-1.193E-05	1.236E-03	-2.670E-01
1780	34.8	(°)	6.92	-1.193E-05	1.236E-03	-2.670E-01
1781	29.4	(°)	6.48	-1.193E-05	1.236E-03	-2.670E-01
1782	25.5	(°)	6.17	-1.193E-05	1.236E-03	-2.670E-01
1783	22.5	(°)	5.93	-1.193E-05	1.236E-03	-2.670E-01
1784	18.6	(°)	5.63	-1.193E-05	1.236E-03	-2.670E-01
1785	13.6	(°)	5.22	-1.193E-05	1.236E-03	-2.670E-01
1786	12	9.3	4.97	-1.193E-05	1.236E-03	-2.670E-01
1787	41.9	(°)	5.43	-1.193E-05	1.236E-03	-2.670E-01
1788	35.6	(°)	5.06	-1.193E-05	1.236E-03	-2.670E-01
1789	37.1	2	5.14	-1.193E-05	1.236E-03	-2.670E-01
1790	39.1	0.7	5.25	-1.193E-05	1.236E-03	-2.670E-01
1791	41.4	2	5.38	-1.193E-05	1.236E-03	-2.670E-01
1792	42.3	(°)	5.44	-1.193E-05	1.236E-03	-2.670E-01
1793	39	(°)	5.26	-1.193E-05	1.236E-03	-2.670E-01
1794	36.5	0.4	5.1	-1.193E-05	1.236E-03	-2.670E-01
1795	40.6	4.2	5.33	-1.193E-05	1.236E-03	-2.670E-01
1796	49.4	4.5	5.84	-1.193E-05	1.236E-03	-2.670E-01
1797	55	1	6.17	-1.193E-05	1.236E-03	-2.670E-01
1798	53	(°)	6.06	-1.193E-05	1.236E-03	-2.670E-01
1799	48.6	(°)	5.81	-1.193E-05	1.236E-03	-2.670E-01

1800	49.8	3.9	5.86	-1.193E-05	1.236E-03	-2.670E-01
1801	60.1	4.3	6.45	-1.193E-05	1.236E-03	-2.670E-01
1802	59.2	12.8	6.71	-3.978E-06	4.119E-04	-8.900E-02
1803	35.1	(°)	6.94	3.978E-06	-4.119E-04	8.900E-02
1804	29.4	(°)	6.49	1.193E-05	-1.236E-03	2.670E-01
1805	23.2	(°)	5.99	1.193E-05	-1.236E-03	2.670E-01
1806	13.8	(°)	5.25	1.193E-05	-1.236E-03	2.670E-01
1807	20.3	7.8	3.96	1.193E-05	-1.236E-03	2.670E-01
1808	0	0	3.07	1.193E-05	-1.236E-03	2.670E-01
1809	0	0	2.21	1.193E-05	-1.236E-03	2.670E-01
1810	0	0	0.78	3.978E-06	-4.119E-04	8.900E-02
1811	7.1	19.8	1.71	-3.978E-06	4.119E-04	-8.900E-02
1812	19.5	10.8	2.93	-1.193E-05	1.236E-03	-2.670E-01
1813	43.5	8.5	3.89	-1.193E-05	1.236E-03	-2.670E-01
1814	61.5	5.7	4.64	-1.193E-05	1.236E-03	-2.670E-01
1815	39.7	5.8	4.98	-1.193E-05	1.236E-03	-2.670E-01
1816	33.9	(°)	4.96	-1.193E-05	1.236E-03	-2.670E-01
1817	33	1.1	4.9	-1.193E-05	1.236E-03	-2.670E-01
1818	37.8	3.2	5.17	-1.193E-05	1.236E-03	-2.670E-01
1819	36.2	(°)	5.1	-1.193E-05	1.236E-03	-2.670E-01
1820	36.4	2.4	5.09	-1.193E-05	1.236E-03	-2.670E-01
1821	44	5.4	5.52	-1.193E-05	1.236E-03	-2.670E-01
1822	49	0.9	5.82	-1.193E-05	1.236E-03	-2.670E-01
1823	52.2	2.6	6.01	-1.193E-05	1.236E-03	-2.670E-01
1824	55.4	1.1	6.19	-1.193E-05	1.236E-03	-2.670E-01
1825	58.4	2.2	6.36	-1.193E-05	1.236E-03	-2.670E-01
1826	66.4	9.6	6.81	-1.193E-05	1.236E-03	-2.670E-01
1827	37.6	1.9	7.12	-1.193E-05	1.236E-03	-2.670E-01
1828	37.6	(°)	7.12	-1.193E-05	1.236E-03	-2.670E-01
1829	39.3	1.9	7.26	-1.193E-05	1.236E-03	-2.670E-01
1830	42.6	2.4	7.52	-1.193E-05	1.236E-03	-2.670E-01
1831	44.4	0.2	7.66	-1.193E-05	1.236E-03	-2.670E-01
1832	45.7	0.9	7.77	-1.193E-05	1.236E-03	-2.670E-01
1833	48	1	7.95	-3.978E-06	4.119E-04	-8.900E-02
1834	45	(°)	7.73	3.978E-06	-4.119E-04	8.900E-02
1835	38.7	(°)	7.23	1.193E-05	-1.236E-03	2.670E-01
1836	32.8	(°)	6.76	1.193E-05	-1.236E-03	2.670E-01
1837	25.6	(°)	6.2	1.193E-05	-1.236E-03	2.670E-01
1838	4.9	0.8	4.18	3.978E-06	-4.119E-04	8.900E-02
1839	0.1	3.9	0	-3.978E-06	4.119E-04	-8.900E-02
1840	0	0	0	-1.193E-05	1.236E-03	-2.670E-01
1852	0	0	0	-1.193E-05	1.236E-03	-2.670E-01
1853	1	6.7	0.15	-1.193E-05	1.236E-03	-2.670E-01
1854	6.8	21.9	1.3	-1.193E-05	1.236E-03	-2.670E-01
1855	17.1	11.1	2.83	-1.193E-05	1.236E-03	-2.670E-01
1856	35	5.6	3.56	-1.193E-05	1.236E-03	-2.670E-01
1857	35.7	(°)	3.61	-1.193E-05	1.236E-03	-2.670E-01
1858	21.8	(°)	3.05	-1.193E-05	1.236E-03	-2.670E-01
1859	0	0	1.16	-1.193E-05	1.236E-03	-2.670E-01
1860	0	0	0	-1.193E-05	1.236E-03	-2.670E-01
1865	0	0	0	-1.193E-05	1.236E-03	-2.670E-01
1866	2.5	6.8	0.17	-1.193E-05	1.236E-03	-2.670E-01
1867	5.6	12.3	1.42	-1.193E-05	1.236E-03	-2.670E-01
1868	4.4	4.8	1.97	-1.193E-05	1.236E-03	-2.670E-01
1869	0	0	1.94	-1.193E-05	1.236E-03	-2.670E-01
1870	0	0	0.16	-1.193E-05	1.236E-03	-2.670E-01
1871	0	0	0	-1.193E-05	1.236E-03	-2.670E-01
1872	1.6	6.5	0.17	-1.193E-05	1.236E-03	-2.670E-01
1873	5.1	9.6	1.08	-1.193E-05	1.236E-03	-2.670E-01
1874	3.4	5.8	1.54	-1.193E-05	1.236E-03	-2.670E-01
1875	0	0	1.56	-1.193E-05	1.236E-03	-2.670E-01
1876	0	0	0	-1.193E-05	1.236E-03	-2.670E-01
1878	0	0	0	-1.193E-05	1.236E-03	-2.670E-01
1879	1.3	6.6	0.18	-1.193E-05	1.236E-03	-2.670E-01
1880	4.8	7.7	0.88	-1.193E-05	1.236E-03	-2.670E-01
1881	0.8	5.4	1.29	-1.193E-05	1.236E-03	-2.670E-01
1882	0	0	1.67	-1.193E-05	1.236E-03	-2.670E-01
1883	0.3	4.4	2.01	-1.193E-05	1.236E-03	-2.670E-01
1884	0	0	2.09	-1.193E-05	1.236E-03	-2.670E-01
1885	0	0	2.14	-1.193E-05	1.236E-03	-2.670E-01
1886	0	0	2.12	-1.193E-05	1.236E-03	-2.670E-01
1887	0	0	1.9	-1.193E-05	1.236E-03	-2.670E-01

1888	0	0	0.4	-1.193E-05	1.236E-03	-2.670E-01
1889	0	0	0	-1.193E-05	1.236E-03	-2.670E-01
1899	0	0	0	-1.193E-05	1.236E-03	-2.670E-01
1900	0	0	0	-7.980E-06	-5.261E-04	6.348E-01
1901	0	0	0	-4.026E-06	-2.288E-03	1.537E+00
1902	0	0	0	-7.340E-08	-4.050E-03	2.438E+00
2135	0	0	0	-7.340E-08	-4.050E-03	2.438E+00
2136	51.7	18.5	4.1	-7.340E-08	-4.050E-03	2.438E+00
2137	10.6	6.5	3.04	-7.340E-08	-4.050E-03	2.438E+00
2138	0	0	2.62	-7.340E-08	-4.050E-03	2.438E+00
2139	18.6	7.7	3.59	-7.340E-08	-4.050E-03	2.438E+00
2140	6.2	0.7	2.95	-7.340E-08	-4.050E-03	2.438E+00
2141	0	0	0	-7.340E-08	-4.050E-03	2.438E+00
2167	0	0	0	-7.340E-08	-4.050E-03	2.438E+00
2168	7.1	34.5	0.61	-7.340E-08	-4.050E-03	2.438E+00
2169	10.6	19.6	2.34	-7.340E-08	-4.050E-03	2.438E+00
2170	29.3	11.2	3.07	-7.340E-08	-4.050E-03	2.438E+00
2171	41.5	3.5	3.52	-7.340E-08	-4.050E-03	2.438E+00
2172	37	(°)	3.36	-7.340E-08	-4.050E-03	2.438E+00
2173	22.1	(°)	2.8	-7.340E-08	-4.050E-03	2.438E+00
2174	2.6	0.5	1.82	-7.340E-08	-4.050E-03	2.438E+00
2175	0.1	2.5	0	-7.340E-08	-4.050E-03	2.438E+00
2176	8.3	41.2	1.26	-7.340E-08	-4.050E-03	2.438E+00
2177	27	19.8	2.97	-7.340E-08	-4.050E-03	2.438E+00
2178	48.7	11.1	3.78	-7.340E-08	-4.050E-03	2.438E+00
2179	61.9	9.8	4.28	-7.340E-08	-4.050E-03	2.438E+00
2180	30.5	2.3	4.11	-7.340E-08	-4.050E-03	2.438E+00
2181	25.4	(°)	3.95	-7.340E-08	-4.050E-03	2.438E+00
2182	5.8	0.5	2.82	-7.340E-08	-4.050E-03	2.438E+00
2183	0	0	0	-7.340E-08	-4.050E-03	2.438E+00
2192	0	0	0	-7.340E-08	-4.050E-03	2.438E+00
2193	0.9	7.1	0.05	-7.340E-08	-4.050E-03	2.438E+00
2194	8.1	40.6	1.58	-7.340E-08	-4.050E-03	2.438E+00
2195	27.4	18.8	2.99	-7.340E-08	-4.050E-03	2.438E+00
2196	46.8	10	3.71	-7.340E-08	-4.050E-03	2.438E+00
2197	54.8	2	4.02	-7.340E-08	-4.050E-03	2.438E+00
2198	54.2	1.2	4	-7.340E-08	-4.050E-03	2.438E+00
2199	50.7	2.7	3.87	-7.340E-08	-4.050E-03	2.438E+00
2200	50.4	4.4	3.85	-7.340E-08	-4.050E-03	2.438E+00
2201	53.4	4	3.97	-7.340E-08	-4.050E-03	2.438E+00
2202	56.1	3.1	4.07	-7.340E-08	-4.050E-03	2.438E+00
2203	34.8	6.4	4.13	-7.340E-08	-4.050E-03	2.438E+00
2204	31.5	2.3	4.25	-7.340E-08	-4.050E-03	2.438E+00
2205	32.1	2.4	4.28	-7.340E-08	-4.050E-03	2.438E+00
2206	31.4	2.7	4.24	-7.340E-08	-4.050E-03	2.438E+00
2207	31.4	2.4	4.24	-7.340E-08	-4.050E-03	2.438E+00
2208	32.5	2.3	4.3	-7.340E-08	-4.050E-03	2.438E+00
2209	31.8	1.5	4.27	-7.340E-08	-4.050E-03	2.438E+00
2210	29.8	(°)	4.17	-7.340E-08	-4.050E-03	2.438E+00
2211	21.4	(°)	3.74	-7.340E-08	-4.050E-03	2.438E+00
2212	8.8	0.5	3.11	-7.340E-08	-4.050E-03	2.438E+00
2213	0	0	0	-7.340E-08	-4.050E-03	2.438E+00
2222	0	0	0	-7.340E-08	-4.050E-03	2.438E+00
2223	3.6	10.8	0.05	-7.340E-08	-4.050E-03	2.438E+00
2224	6.7	25.7	1.52	-7.340E-08	-4.050E-03	2.438E+00
2225	14.1	13.6	2.48	-7.340E-08	-4.050E-03	2.438E+00
2226	27.4	8	3	-7.340E-08	-4.050E-03	2.438E+00
2227	44	10.3	3.6	-7.340E-08	-4.050E-03	2.438E+00
2228	59	7.6	4.17	-7.340E-08	-4.050E-03	2.438E+00
2229	33.4	1.8	4.21	-7.340E-08	-4.050E-03	2.438E+00
2230	39.5	11.1	4.64	-7.340E-08	-4.050E-03	2.438E+00
2231	47.5	4.3	5.06	-7.340E-08	-4.050E-03	2.438E+00
2232	43.9	(°)	4.89	-7.340E-08	-4.050E-03	2.438E+00
2233	33.7	(°)	4.37	-7.340E-08	-4.050E-03	2.438E+00
2234	21.6	(°)	3.76	-7.340E-08	-4.050E-03	2.438E+00
2235	10.3	(°)	3.18	-7.340E-08	-4.050E-03	2.438E+00
2236	0	0	2.52	-7.340E-08	-4.050E-03	2.438E+00
2237	0	0	0.23	-7.340E-08	-4.050E-03	2.438E+00
2238	0	0	0	-7.340E-08	-4.050E-03	2.438E+00
2239	0	0	0	-7.340E-08	-4.050E-03	2.438E+00
2240	0	0	0	2.707E-06	-6.116E-03	2.089E+00
2241	0	0	0	5.488E-06	-8.182E-03	1.740E+00

2242	0	0	0	8.269E-06	-1.025E-02	1.390E+00
2298	0	0	0	8.269E-06	-1.025E-02	1.390E+00
2299	2.1	7.2	0	8.269E-06	-1.025E-02	1.390E+00
2300	8.7	49.6	1.87	8.269E-06	-1.025E-02	1.390E+00
2301	51.5	35.1	3.84	8.269E-06	-1.025E-02	1.390E+00
2302	68.4	21.2	5.23	8.269E-06	-1.025E-02	1.390E+00
2303	72.7	25.8	6.26	8.269E-06	-1.025E-02	1.390E+00
2304	57.9	7.7	7.16	8.269E-06	-1.025E-02	1.390E+00
2305	58.4	36.2	7.53	8.269E-06	-1.025E-02	1.390E+00
2306	106.4	37.8	10.52	8.269E-06	-1.025E-02	1.390E+00
2307	32.6	2.2	10.28	8.269E-06	-1.025E-02	1.390E+00
2308	42.1	98.8	11.65	8.269E-06	-1.025E-02	1.390E+00
2309	64.9	21	14.54	2.756E-06	-3.416E-03	4.635E-01
2310	65	0.2	14.6	-2.756E-06	3.416E-03	-4.635E-01
2311	36.2	(°)	14.29	-8.269E-06	1.025E-02	-1.390E+00
2312	29.8	(°)	13.76	-8.269E-06	1.025E-02	-1.390E+00
2313	25.8	(°)	13.08	-8.269E-06	1.025E-02	-1.390E+00
2314	22.5	(°)	12.52	-8.269E-06	1.025E-02	-1.390E+00
2315	19.3	(°)	11.99	-8.269E-06	1.025E-02	-1.390E+00
2316	17	(°)	11.6	-8.269E-06	1.025E-02	-1.390E+00
2317	15.4	4.1	11.32	-8.269E-06	1.025E-02	-1.390E+00
2318	14.4	1.5	11.15	-8.269E-06	1.025E-02	-1.390E+00
2319	12.9	(°)	10.91	-8.269E-06	1.025E-02	-1.390E+00
2320	11.6	8.8	10.11	-8.269E-06	1.025E-02	-1.390E+00
2321	24.3	1.8	9.3	-8.269E-06	1.025E-02	-1.390E+00
2322	18.2	(°)	8.77	-8.269E-06	1.025E-02	-1.390E+00
2323	14.3	(°)	8.28	-8.269E-06	1.025E-02	-1.390E+00
2324	9.9	(°)	7.75	-8.269E-06	1.025E-02	-1.390E+00
2325	10.9	3	5.41	-8.269E-06	1.025E-02	-1.390E+00
2326	5.6	0.7	2.62	-8.269E-06	1.025E-02	-1.390E+00
2327	0	0	1.42	-8.269E-06	1.025E-02	-1.390E+00
2328	3.4	7	1.3	-2.756E-06	3.416E-03	-4.635E-01
2329	6.3	10.9	2.04	2.756E-06	-3.416E-03	4.635E-01
2330	6.2	3.5	2.17	8.269E-06	-1.025E-02	1.390E+00
2331	0	0	1.97	8.269E-06	-1.025E-02	1.390E+00
2332	0	0	1.16	8.269E-06	-1.025E-02	1.390E+00
2333	8.7	36.1	1.99	8.269E-06	-1.025E-02	1.390E+00
2334	47.4	34.5	3.7	8.269E-06	-1.025E-02	1.390E+00
2335	74.6	30.1	4.78	8.269E-06	-1.025E-02	1.390E+00
2336	38.3	1.3	4.59	8.269E-06	-1.025E-02	1.390E+00
2337	88.1	38	7.02	8.269E-06	-1.025E-02	1.390E+00
2338	50.5	0.8	6.88	8.269E-06	-1.025E-02	1.390E+00
2339	68.9	46.4	8.24	8.269E-06	-1.025E-02	1.390E+00
2340	69.6	16.4	9.79	8.269E-06	-1.025E-02	1.390E+00
2341	55.1	35.9	9.94	8.269E-06	-1.025E-02	1.390E+00
2342	83.9	29.4	12.63	8.269E-06	-1.025E-02	1.390E+00
2343	87.2	12.3	12.98	8.269E-06	-1.025E-02	1.390E+00
2344	58.8	6.3	13.3	8.269E-06	-1.025E-02	1.390E+00
2345	59.1	52.5	13.78	8.269E-06	-1.025E-02	1.390E+00
2346	85.8	67.1	17.03	8.269E-06	-1.025E-02	1.390E+00
2347	67.4	11.5	18.36	8.269E-06	-1.025E-02	1.390E+00
2348	56.8	47.6	18.22	8.269E-06	-1.025E-02	1.390E+00
2349	69.9	76.1	20.33	8.269E-06	-1.025E-02	1.390E+00
2350	86.8	76.3	23.13	8.269E-06	-1.025E-02	1.390E+00
2351	49.1	0.6	22.57	8.269E-06	-1.025E-02	1.390E+00
2352	45.4	64.4	22.1	8.269E-06	-1.025E-02	1.390E+00
2353	51.4	80.2	23.4	8.269E-06	-1.025E-02	1.390E+00
2354	60.2	89.5	25.38	8.269E-06	-1.025E-02	1.390E+00
2355	69.5	87.4	27.47	8.269E-06	-1.025E-02	1.390E+00
2356	77.8	85.8	29.37	8.269E-06	-1.025E-02	1.390E+00
2357	48.5	7.2	29.12	8.269E-06	-1.025E-02	1.390E+00
2358	40.2	50.8	28.2	8.269E-06	-1.025E-02	1.390E+00
2359	42	78.2	28.69	8.269E-06	-1.025E-02	1.390E+00
2360	45.9	91.3	29.83	8.269E-06	-1.025E-02	1.390E+00
2361	50.4	95.9	31.2	8.269E-06	-1.025E-02	1.390E+00
2362	50.7	6.9	31.45	8.269E-06	-1.025E-02	1.390E+00
2363	48.4	11.9	30.75	2.756E-06	-3.416E-03	4.635E-01
2364	49.2	(°)	31.06	-2.756E-06	3.416E-03	-4.635E-01
2365	45.8	(°)	30.05	-8.269E-06	1.025E-02	-1.390E+00
2366	44.2	(°)	29.49	-8.269E-06	1.025E-02	-1.390E+00
2367	41.5	(°)	28.7	-8.269E-06	1.025E-02	-1.390E+00
2368	38.7	(°)	27.84	-8.269E-06	1.025E-02	-1.390E+00



2369	36.4	(°)	27.12	-8.269E-06	1.025E-02	-1.390E+00
2370	34.2	(°)	26.47	-8.269E-06	1.025E-02	-1.390E+00
2371	33.2	(°)	26.14	-8.269E-06	1.025E-02	-1.390E+00
2372	31.5	(°)	25.6	-8.269E-06	1.025E-02	-1.390E+00
2373	30.4	(°)	25.27	-8.269E-06	1.025E-02	-1.390E+00
2374	29.3	13.2	24.91	-8.269E-06	1.025E-02	-1.390E+00
2375	28.7	(°)	24.76	-8.269E-06	1.025E-02	-1.390E+00
2376	23.6	(°)	23.24	-8.269E-06	1.025E-02	-1.390E+00
2377	16.8	3.9	20.72	-8.269E-06	1.025E-02	-1.390E+00
2378	36	(°)	20.05	-8.269E-06	1.025E-02	-1.390E+00
2379	36.6	(°)	20.21	-8.269E-06	1.025E-02	-1.390E+00
2380	32.9	(°)	19.43	-8.269E-06	1.025E-02	-1.390E+00
2381	26.9	(°)	18.01	-8.269E-06	1.025E-02	-1.390E+00
2382	26.4	(°)	17.88	-8.269E-06	1.025E-02	-1.390E+00
2383	25.6	(°)	17.73	-8.269E-06	1.025E-02	-1.390E+00
2384	18.1	(°)	16.06	-8.269E-06	1.025E-02	-1.390E+00
2385	33	5.8	13.87	-8.269E-06	1.025E-02	-1.390E+00
2386	19.4	(°)	12.07	-8.269E-06	1.025E-02	-1.390E+00
2387	9.8	4.3	10.05	-8.269E-06	1.025E-02	-1.390E+00
2388	20.7	1.1	8.91	-8.269E-06	1.025E-02	-1.390E+00
2389	18.7	(°)	8.83	-8.269E-06	1.025E-02	-1.390E+00
2390	13.9	(°)	8.25	-8.269E-06	1.025E-02	-1.390E+00
2391	12.8	(°)	8.1	-2.756E-06	3.416E-03	-4.635E-01
2392	14.2	(°)	8.27	2.756E-06	-3.416E-03	4.635E-01
2393	16.4	4.2	8.54	8.269E-06	-1.025E-02	1.390E+00
2394	21.4	9.2	9.15	8.269E-06	-1.025E-02	1.390E+00
2395	23.7	4.3	9.45	8.269E-06	-1.025E-02	1.390E+00
2396	24.9	5.7	9.59	8.269E-06	-1.025E-02	1.390E+00
2397	27.2	6.4	9.87	8.269E-06	-1.025E-02	1.390E+00
2398	29.1	10.6	10.11	8.269E-06	-1.025E-02	1.390E+00
2399	34.4	19.3	10.75	8.269E-06	-1.025E-02	1.390E+00
2400	44.5	25.5	12	8.269E-06	-1.025E-02	1.390E+00
2401	55.9	22	13.43	8.269E-06	-1.025E-02	1.390E+00
2402	58	4.2	13.72	8.269E-06	-1.025E-02	1.390E+00
2403	50.3	14.9	13.98	8.269E-06	-1.025E-02	1.390E+00
2404	31.4	31.9	13.97	8.269E-06	-1.025E-02	1.390E+00
2405	38.9	18.9	15.25	8.269E-06	-1.025E-02	1.390E+00
2406	39.4	(°)	15.36	8.269E-06	-1.025E-02	1.390E+00
2407	36.4	(°)	14.87	8.269E-06	-1.025E-02	1.390E+00
2408	31.3	(°)	14.03	8.269E-06	-1.025E-02	1.390E+00
2409	24.5	(°)	12.87	8.269E-06	-1.025E-02	1.390E+00
2410	18.6	(°)	11.89	8.269E-06	-1.025E-02	1.390E+00
2411	14.9	(°)	11.27	8.269E-06	-1.025E-02	1.390E+00
2412	8.9	(°)	10.3	8.269E-06	-1.025E-02	1.390E+00
2413	33	6	10.6	8.269E-06	-1.025E-02	1.390E+00
2414	36.4	28.9	11.01	8.269E-06	-1.025E-02	1.390E+00
2415	45.1	24.4	12.08	8.269E-06	-1.025E-02	1.390E+00
2416	50.9	12.1	12.82	8.269E-06	-1.025E-02	1.390E+00
2417	54.2	6.3	13.24	8.269E-06	-1.025E-02	1.390E+00
2418	53.3	(°)	13.14	8.269E-06	-1.025E-02	1.390E+00
2419	52.5	3.6	13.04	8.269E-06	-1.025E-02	1.390E+00
2420	53.9	6.8	13.2	8.269E-06	-1.025E-02	1.390E+00
2421	54.2	7.5	13.24	8.269E-06	-1.025E-02	1.390E+00
2422	53	6	13.09	8.269E-06	-1.025E-02	1.390E+00
2423	54.2	7.9	13.24	8.269E-06	-1.025E-02	1.390E+00
2424	57.8	8.1	13.69	8.269E-06	-1.025E-02	1.390E+00
2425	61.4	14	14.12	8.269E-06	-1.025E-02	1.390E+00
2426	34.1	1	14.14	8.269E-06	-1.025E-02	1.390E+00
2427	38.7	56.4	15.16	8.269E-06	-1.025E-02	1.390E+00
2428	57.6	68.8	18.28	8.269E-06	-1.025E-02	1.390E+00
2429	68.9	33.9	20.25	4.866E-06	-6.427E-03	5.912E-01
2430	79.9	55.8	22.04	1.464E-06	-2.605E-03	-2.080E-01
2431	72.1	21.5	23.5	-1.939E-06	1.217E-03	-1.007E+00
2432	51.1	43.7	23.42	-1.939E-06	1.217E-03	-1.007E+00
2433	59.3	80.6	25.21	-1.939E-06	1.217E-03	-1.007E+00
2434	71.3	82	27.89	-1.939E-06	1.217E-03	-1.007E+00
2435	78.4	27.2	29.63	-1.939E-06	1.217E-03	-1.007E+00
2436	45.9	2.1	29.47	-1.939E-06	1.217E-03	-1.007E+00
2437	46.3	70.5	30.03	-1.939E-06	1.217E-03	-1.007E+00
2438	52.4	83.4	31.83	-1.939E-06	1.217E-03	-1.007E+00
2439	59.1	50.7	33.93	-1.939E-06	1.217E-03	-1.007E+00
2440	59.6	21.4	34.17	-1.939E-06	1.217E-03	-1.007E+00

2441	61.4	19	34.46	-1.939E-06	1.217E-03	-1.007E+00
2442	30.4	2.9	34.14	-1.939E-06	1.217E-03	-1.007E+00
2443	31	36.2	34.54	-1.939E-06	1.217E-03	-1.007E+00
2444	31.7	30.6	34.83	-1.939E-06	1.217E-03	-1.007E+00
2445	32.1	13	35.01	-1.939E-06	1.217E-03	-1.007E+00
2446	32.1	22	35	-1.939E-06	1.217E-03	-1.007E+00
2447	31.8	(°)	34.93	-1.939E-06	1.217E-03	-1.007E+00
2448	31.2	17.8	34.64	-1.939E-06	1.217E-03	-1.007E+00
2449	30.8	(°)	34.51	-1.939E-06	1.217E-03	-1.007E+00
2450	29.5	(°)	33.99	-1.939E-06	1.217E-03	-1.007E+00
2451	28.4	(°)	33.51	-1.939E-06	1.217E-03	-1.007E+00
2452	28.4	28.8	33.46	-1.939E-06	1.217E-03	-1.007E+00
2453	29.1	23.2	33.77	-1.939E-06	1.217E-03	-1.007E+00
2454	29.8	21.1	34.07	-1.939E-06	1.217E-03	-1.007E+00
2455	30.6	19.6	34.4	-1.939E-06	1.217E-03	-1.007E+00
2456	31.6	15	34.8	-1.939E-06	1.217E-03	-1.007E+00
2457	32.4	7.4	35.18	-1.939E-06	1.217E-03	-1.007E+00
2458	33.4	7.3	35.58	-1.939E-06	1.217E-03	-1.007E+00
2459	34.2	(°)	35.94	-1.939E-06	1.217E-03	-1.007E+00
2460	35	(°)	36.27	-1.939E-06	1.217E-03	-1.007E+00
2461	35.8	(°)	36.6	-1.939E-06	1.217E-03	-1.007E+00
2462	36	(°)	36.71	-1.939E-06	1.217E-03	-1.007E+00
2463	35.9	(°)	36.64	-1.939E-06	1.217E-03	-1.007E+00
2464	35.6	(°)	36.51	-1.939E-06	1.217E-03	-1.007E+00
2465	34.9	(°)	36.22	-1.939E-06	1.217E-03	-1.007E+00
2466	34	(°)	35.86	-1.939E-06	1.217E-03	-1.007E+00
2467	33.3	16.5	35.53	-1.939E-06	1.217E-03	-1.007E+00
2468	33.2	14.2	35.51	-1.939E-06	1.217E-03	-1.007E+00
2469	33.6	38.9	35.61	-1.939E-06	1.217E-03	-1.007E+00
2470	34.4	47.8	35.93	-1.939E-06	1.217E-03	-1.007E+00
2471	34.9	38.6	36.15	-1.939E-06	1.217E-03	-1.007E+00
2472	34.8	40.6	36.09	-1.939E-06	1.217E-03	-1.007E+00
2473	34.7	45.1	36.05	-1.939E-06	1.217E-03	-1.007E+00
2474	34.3	38.1	35.92	-1.939E-06	1.217E-03	-1.007E+00
2475	34.4	60.8	35.91	-1.939E-06	1.217E-03	-1.007E+00
2476	33.6	(°)	35.69	-1.939E-06	1.217E-03	-1.007E+00
2477	30.3	1	34.29	-1.939E-06	1.217E-03	-1.007E+00
2478	28.4	(°)	33.5	-1.939E-06	1.217E-03	-1.007E+00
2479	26.7	11.3	32.79	-1.939E-06	1.217E-03	-1.007E+00
2480	26.4	37.8	32.61	-1.939E-06	1.217E-03	-1.007E+00
2481	27.2	60.2	32.93	-1.939E-06	1.217E-03	-1.007E+00
2482	30	78.9	34.07	-1.939E-06	1.217E-03	-1.007E+00
2483	32	65.3	34.93	-1.939E-06	1.217E-03	-1.007E+00
2484	33.1	11.8	35.46	-1.939E-06	1.217E-03	-1.007E+00
2485	33.4	25.9	35.55	-1.939E-06	1.217E-03	-1.007E+00
2486	34.1	31	35.85	-1.939E-06	1.217E-03	-1.007E+00
2487	34.2	0.5	35.92	-1.939E-06	1.217E-03	-1.007E+00
2488	34.9	47.5	36.12	-1.939E-06	1.217E-03	-1.007E+00
2489	36.9	39.9	37	-1.939E-06	1.217E-03	-1.007E+00
2490	38.1	44.3	37.5	-1.939E-06	1.217E-03	-1.007E+00
2491	40.2	62.9	38.31	-1.939E-06	1.217E-03	-1.007E+00
2492	42.4	52.1	39.27	-1.939E-06	1.217E-03	-1.007E+00
2493	42.9	4.8	39.53	-1.939E-06	1.217E-03	-1.007E+00
2494	42.5	12.5	39.36	-1.939E-06	1.217E-03	-1.007E+00
2495	42.5	17	39.34	-1.939E-06	1.217E-03	-1.007E+00
2496	42.7	28	39.43	-1.939E-06	1.217E-03	-1.007E+00
2497	42.8	15	39.5	-1.939E-06	1.217E-03	-1.007E+00
2498	42.9	17.8	39.51	-1.939E-06	1.217E-03	-1.007E+00
2499	43	21.5	39.57	-1.939E-06	1.217E-03	-1.007E+00
2500	43.2	20	39.64	-1.939E-06	1.217E-03	-1.007E+00
2501	43.5	24.6	39.76	-1.939E-06	1.217E-03	-1.007E+00
2502	44.2	31.9	40.02	-1.939E-06	1.217E-03	-1.007E+00
2503	44.1	4.6	40.03	-1.939E-06	1.217E-03	-1.007E+00
2504	44	24.5	39.98	-1.939E-06	1.217E-03	-1.007E+00
2505	44	8.7	39.99	-1.939E-06	1.217E-03	-1.007E+00
2506	43.4	4.4	39.75	-1.939E-06	1.217E-03	-1.007E+00
2507	43.1	14	39.6	-1.939E-06	1.217E-03	-1.007E+00
2508	42.6	4.2	39.43	-1.939E-06	1.217E-03	-1.007E+00
2509	41.7	(°)	39.05	-1.939E-06	1.217E-03	-1.007E+00
2510	41.2	13.6	38.82	-1.939E-06	1.217E-03	-1.007E+00
2511	40.8	6.5	38.69	-1.939E-06	1.217E-03	-1.007E+00
2512	40.7	20.3	38.62	-1.939E-06	1.217E-03	-1.007E+00

2513	39.8	(°)	38.3	-1.939E-06	1.217E-03	-1.007E+00
2514	39	14.7	37.92	-1.939E-06	1.217E-03	-1.007E+00
2515	39.3	24.9	37.99	-1.939E-06	1.217E-03	-1.007E+00
2516	38.9	(°)	37.87	-1.939E-06	1.217E-03	-1.007E+00
2517	38.5	15.5	37.69	-1.939E-06	1.217E-03	-1.007E+00
2518	38	(°)	37.49	-1.939E-06	1.217E-03	-1.007E+00
2519	37.3	7	37.22	-1.939E-06	1.217E-03	-1.007E+00
2520	36.4	(°)	36.84	-1.939E-06	1.217E-03	-1.007E+00
2521	35.3	(°)	36.4	-1.939E-06	1.217E-03	-1.007E+00
2522	34.1	(°)	35.89	-1.939E-06	1.217E-03	-1.007E+00
2523	32.8	(°)	35.34	-1.939E-06	1.217E-03	-1.007E+00
2524	30.7	(°)	34.5	-1.939E-06	1.217E-03	-1.007E+00
2525	28.9	(°)	33.74	-1.939E-06	1.217E-03	-1.007E+00
2526	27.8	(°)	33.25	-1.939E-06	1.217E-03	-1.007E+00
2527	26.7	(°)	32.79	-1.939E-06	1.217E-03	-1.007E+00
2528	26.4	20	32.65	-1.939E-06	1.217E-03	-1.007E+00
2529	26.8	24.1	32.81	-1.939E-06	1.217E-03	-1.007E+00
2530	27.1	15.6	32.94	-1.939E-06	1.217E-03	-1.007E+00
2531	27.6	29.9	33.13	-1.939E-06	1.217E-03	-1.007E+00
2532	28.3	31.9	33.43	-1.939E-06	1.217E-03	-1.007E+00
2533	28.6	14.2	33.58	-1.939E-06	1.217E-03	-1.007E+00
2534	29.3	37.8	33.83	-1.939E-06	1.217E-03	-1.007E+00
2535	30.6	43.6	34.36	-1.939E-06	1.217E-03	-1.007E+00
2536	31.9	34.4	34.91	-1.939E-06	1.217E-03	-1.007E+00
2537	31.6	0.9	34.86	-1.939E-06	1.217E-03	-1.007E+00
2538	32.1	38.6	35	-1.939E-06	1.217E-03	-1.007E+00
2539	32.6	0.8	35.28	-1.939E-06	1.217E-03	-1.007E+00
2540	32	(°)	35.02	-1.939E-06	1.217E-03	-1.007E+00
2541	32	20	34.99	-1.939E-06	1.217E-03	-1.007E+00
2542	32.1	2.5	35.06	-1.939E-06	1.217E-03	-1.007E+00
2543	31.3	(°)	34.72	-1.939E-06	1.217E-03	-1.007E+00
2544	30.3	(°)	34.3	-1.939E-06	1.217E-03	-1.007E+00
2545	29.5	(°)	34.06	-1.939E-06	1.217E-03	-1.007E+00
2546	27.9	(°)	33.4	-1.939E-06	1.217E-03	-1.007E+00
2547	26.1	(°)	32.58	-1.939E-06	1.217E-03	-1.007E+00
2548	24.8	(°)	32.04	-1.939E-06	1.217E-03	-1.007E+00
2549	23.1	39.1	31.24	-1.939E-06	1.217E-03	-1.007E+00
2550	22.3	56.9	30.88	-1.939E-06	1.217E-03	-1.007E+00
2551	24.3	68.3	31.7	-1.939E-06	1.217E-03	-1.007E+00
2552	25.9	40.5	32.4	-1.939E-06	1.217E-03	-1.007E+00
2553	26.8	24.7	32.8	-1.939E-06	1.217E-03	-1.007E+00
2554	27.5	38.9	33.07	-1.939E-06	1.217E-03	-1.007E+00
2555	28.3	44.5	33.4	-1.939E-06	1.217E-03	-1.007E+00
2556	29	26	33.71	-1.939E-06	1.217E-03	-1.007E+00
2557	29.3	28.1	33.82	-1.939E-06	1.217E-03	-1.007E+00
2558	29.8	33.5	34.06	-1.939E-06	1.217E-03	-1.007E+00
2559	30.4	16.3	34.31	-1.939E-06	1.217E-03	-1.007E+00
2560	30.5	17.6	34.34	-1.939E-06	1.217E-03	-1.007E+00
2561	30.4	9.3	34.34	-1.939E-06	1.217E-03	-1.007E+00
2562	30	1	34.16	-1.939E-06	1.217E-03	-1.007E+00
2563	29.1	(°)	33.82	-1.939E-06	1.217E-03	-1.007E+00
2564	28.4	11.9	33.48	-1.939E-06	1.217E-03	-1.007E+00
2565	28.1	(°)	33.38	-1.939E-06	1.217E-03	-1.007E+00
2566	28.1	30.8	33.33	-1.939E-06	1.217E-03	-1.007E+00
2567	29.1	37.6	33.75	-1.939E-06	1.217E-03	-1.007E+00
2568	30.3	40.6	34.26	-1.939E-06	1.217E-03	-1.007E+00
2569	31.5	24.7	34.77	-1.939E-06	1.217E-03	-1.007E+00
2570	32.4	37.8	35.1	-1.939E-06	1.217E-03	-1.007E+00
2571	33.7	44.2	35.63	-1.939E-06	1.217E-03	-1.007E+00
2572	35.1	37.5	36.22	-1.939E-06	1.217E-03	-1.007E+00
2573	36.2	38.5	36.7	-1.939E-06	1.217E-03	-1.007E+00
2574	36.2	(°)	36.77	-1.939E-06	1.217E-03	-1.007E+00
2575	36.2	31	36.7	-1.939E-06	1.217E-03	-1.007E+00
2576	36.8	24.9	36.96	-1.939E-06	1.217E-03	-1.007E+00
2577	37.4	26.1	37.21	-1.939E-06	1.217E-03	-1.007E+00
2578	37.8	25.3	37.4	-1.939E-06	1.217E-03	-1.007E+00
2579	38	15.1	37.48	-1.939E-06	1.217E-03	-1.007E+00
2580	38.1	20.9	37.5	-1.939E-06	1.217E-03	-1.007E+00
2581	38.2	18.4	37.56	-1.939E-06	1.217E-03	-1.007E+00
2582	37.7	(°)	37.37	-1.939E-06	1.217E-03	-1.007E+00
2583	37.7	29.6	37.34	-1.939E-06	1.217E-03	-1.007E+00
2584	38.4	21.6	37.63	-1.939E-06	1.217E-03	-1.007E+00

2585	38.7	19.5	37.75	-1.939E-06	1.217E-03	-1.007E+00
2586	39.2	28.1	37.96	-1.939E-06	1.217E-03	-1.007E+00
2587	39.8	27.4	38.21	-1.939E-06	1.217E-03	-1.007E+00
2588	40.2	21.7	38.41	-1.939E-06	1.217E-03	-1.007E+00
2589	40.4	21.5	38.48	-1.939E-06	1.217E-03	-1.007E+00
2590	40.9	32.8	38.66	-1.939E-06	1.217E-03	-1.007E+00
2591	41.7	44.7	38.99	-1.939E-06	1.217E-03	-1.007E+00
2592	41.5	( <sup>e</sup> )	38.97	-1.939E-06	1.217E-03	-1.007E+00
2593	41	29.5	38.69	-1.939E-06	1.217E-03	-1.007E+00
2594	40.4	12.9	38.48	-1.939E-06	1.217E-03	-1.007E+00
2595	39.7	22.7	38.17	-1.939E-06	1.217E-03	-1.007E+00
2596	39.3	22.7	38	-1.939E-06	1.217E-03	-1.007E+00
2597	38.8	21.6	37.81	-1.939E-06	1.217E-03	-1.007E+00
2598	38.5	34.9	37.67	-1.939E-06	1.217E-03	-1.007E+00
2599	38.4	21.9	37.65	-2.270E-06	1.516E-03	-9.082E-01
2600	38.6	31.5	37.73	-2.601E-06	1.815E-03	-8.092E-01
2601	39.1	10.7	37.96	-2.932E-06	2.115E-03	-7.102E-01
2602	39	9.8	37.89	-2.932E-06	2.115E-03	-7.102E-01
2603	38.9	4.6	37.88	-2.932E-06	2.115E-03	-7.102E-01
2604	40	37.2	38.27	-2.932E-06	2.115E-03	-7.102E-01
2605	40.2	( <sup>e</sup> )	38.45	-2.932E-06	2.115E-03	-7.102E-01
2606	41	41.4	38.69	-2.932E-06	2.115E-03	-7.102E-01
2607	42.9	36	39.48	-2.932E-06	2.115E-03	-7.102E-01
2608	42.5	( <sup>e</sup> )	39.39	-2.932E-06	2.115E-03	-7.102E-01
2609	41.2	( <sup>e</sup> )	38.87	-2.932E-06	2.115E-03	-7.102E-01
2610	40.9	23.2	38.69	-2.932E-06	2.115E-03	-7.102E-01
2611	40.9	8.6	38.71	-2.932E-06	2.115E-03	-7.102E-01
2612	40.4	7.5	38.49	-2.932E-06	2.115E-03	-7.102E-01
2613	40.2	13.8	38.42	-2.932E-06	2.115E-03	-7.102E-01
2614	40.4	23.4	38.48	-2.932E-06	2.115E-03	-7.102E-01
2615	40.9	31.8	38.65	-2.932E-06	2.115E-03	-7.102E-01
2616	41.1	21.4	38.77	-2.932E-06	2.115E-03	-7.102E-01
2617	41.8	39	39.02	-2.932E-06	2.115E-03	-7.102E-01
2618	43.1	38.6	39.58	-2.932E-06	2.115E-03	-7.102E-01
2619	43.1	5.1	39.63	-2.932E-06	2.115E-03	-7.102E-01
2620	43.6	42.2	39.79	-2.932E-06	2.115E-03	-7.102E-01
2621	44.9	40.6	40.32	-2.932E-06	2.115E-03	-7.102E-01
2622	44.2	( <sup>e</sup> )	40.09	-2.932E-06	2.115E-03	-7.102E-01
2623	42.8	( <sup>e</sup> )	39.52	-2.932E-06	2.115E-03	-7.102E-01
2624	42.2	29.3	39.22	-2.932E-06	2.115E-03	-7.102E-01
2625	41.8	13.5	39.06	-2.932E-06	2.115E-03	-7.102E-01
2626	41.4	30.6	38.86	-2.932E-06	2.115E-03	-7.102E-01
2627	41.2	15.3	38.8	-2.932E-06	2.115E-03	-7.102E-01
2628	40.8	26.4	38.62	-2.932E-06	2.115E-03	-7.102E-01
2629	40.3	21.9	38.44	-2.932E-06	2.115E-03	-7.102E-01
2630	40.2	30.7	38.39	-2.932E-06	2.115E-03	-7.102E-01
2631	40.2	28.1	38.4	-2.932E-06	2.115E-03	-7.102E-01
2632	40	26.8	38.31	-2.932E-06	2.115E-03	-7.102E-01
2633	40.2	36	38.38	-2.932E-06	2.115E-03	-7.102E-01
2634	40.4	30.7	38.46	-2.932E-06	2.115E-03	-7.102E-01
2635	40.7	38.9	38.58	-2.932E-06	2.115E-03	-7.102E-01
2636	41.2	36.4	38.79	-2.932E-06	2.115E-03	-7.102E-01
2637	41.5	36.5	38.93	-2.932E-06	2.115E-03	-7.102E-01
2638	41.8	35.6	39.02	-2.932E-06	2.115E-03	-7.102E-01
2639	42	35.8	39.1	-2.932E-06	2.115E-03	-7.102E-01
2640	41.6	13.2	38.99	-2.932E-06	2.115E-03	-7.102E-01
2641	41	22.6	38.73	-2.932E-06	2.115E-03	-7.102E-01
2642	41.2	36.5	38.77	-2.932E-06	2.115E-03	-7.102E-01
2643	41.4	29.7	38.88	-2.932E-06	2.115E-03	-7.102E-01
2644	41.5	21.1	38.92	-2.932E-06	2.115E-03	-7.102E-01
2645	41.4	21.8	38.91	-2.932E-06	2.115E-03	-7.102E-01
2646	41.5	20.2	38.92	-2.932E-06	2.115E-03	-7.102E-01
2647	41.6	24	38.96	-2.932E-06	2.115E-03	-7.102E-01
2648	41.7	21.9	39.03	-2.932E-06	2.115E-03	-7.102E-01
2649	41.9	25.3	39.07	-2.932E-06	2.115E-03	-7.102E-01
2650	41	( <sup>e</sup> )	38.79	-2.932E-06	2.115E-03	-7.102E-01
2651	40.9	36.6	38.67	-2.932E-06	2.115E-03	-7.102E-01
2652	41.2	14.7	38.82	-2.932E-06	2.115E-03	-7.102E-01
2653	41.5	32.6	38.9	-2.932E-06	2.115E-03	-7.102E-01
2654	41.8	21.5	39.05	-2.932E-06	2.115E-03	-7.102E-01
2655	41.8	24.1	39.07	-2.932E-06	2.115E-03	-7.102E-01
2656	42	26.5	39.13	-2.932E-06	2.115E-03	-7.102E-01

2657	42	16.9	39.15	-2.932E-06	2.115E-03	-7.102E-01
2658	41.6	18.7	38.98	-2.932E-06	2.115E-03	-7.102E-01
2659	41.6	33.4	38.93	-2.932E-06	2.115E-03	-7.102E-01
2660	42	42.5	39.1	-2.932E-06	2.115E-03	-7.102E-01
2661	43.5	72	39.66	-2.932E-06	2.115E-03	-7.102E-01
2662	45.9	51.3	40.71	-2.932E-06	2.115E-03	-7.102E-01
2663	45.4	(°)	40.61	-2.932E-06	2.115E-03	-7.102E-01
2664	46.1	46.3	40.8	-2.932E-06	2.115E-03	-7.102E-01
2665	47.1	(°)	41.32	-2.932E-06	2.115E-03	-7.102E-01
2666	46.7	9.4	41.11	-2.932E-06	2.115E-03	-7.102E-01
2667	45.7	(°)	40.74	-2.932E-06	2.115E-03	-7.102E-01
2668	44.4	0.1	40.2	-2.932E-06	2.115E-03	-7.102E-01
2669	43.2	(°)	39.7	-2.932E-06	2.115E-03	-7.102E-01
2670	42.5	5.9	39.38	-2.932E-06	2.115E-03	-7.102E-01
2671	42.6	7	39.41	-2.932E-06	2.115E-03	-7.102E-01
2672	42.8	8.9	39.52	-2.932E-06	2.115E-03	-7.102E-01
2673	43.2	(°)	39.69	-2.932E-06	2.115E-03	-7.102E-01
2674	43.4	(°)	39.78	-2.932E-06	2.115E-03	-7.102E-01
2675	43.7	(°)	39.91	-2.932E-06	2.115E-03	-7.102E-01
2676	44.2	(°)	40.1	-2.932E-06	2.115E-03	-7.102E-01
2677	43.3	(°)	39.81	-2.932E-06	2.115E-03	-7.102E-01
2678	42	(°)	39.24	-2.932E-06	2.115E-03	-7.102E-01
2679	40.9	(°)	38.77	-2.932E-06	2.115E-03	-7.102E-01
2680	41	(°)	38.78	-9.772E-07	7.048E-04	-2.367E-01
2681	40.5	(°)	38.59	9.772E-07	-7.048E-04	2.367E-01
2682	39	(°)	37.99	2.932E-06	-2.115E-03	7.102E-01
2683	37.6	(°)	37.38	2.932E-06	-2.115E-03	7.102E-01
2684	36	(°)	36.67	2.932E-06	-2.115E-03	7.102E-01
2685	33.2	(°)	35.53	2.932E-06	-2.115E-03	7.102E-01
2686	32.2	(°)	35.18	2.932E-06	-2.115E-03	7.102E-01
2687	29.5	(°)	34.02	2.932E-06	-2.115E-03	7.102E-01
2688	27.2	(°)	33.01	2.932E-06	-2.115E-03	7.102E-01
2689	24.5	(°)	31.93	2.932E-06	-2.115E-03	7.102E-01
2690	21.5	(°)	30.64	2.932E-06	-2.115E-03	7.102E-01
2691	17.9	(°)	29.19	2.932E-06	-2.115E-03	7.102E-01
2692	37.6	9.6	26.34	2.932E-06	-2.115E-03	7.102E-01
2693	24.4	(°)	23.47	2.932E-06	-2.115E-03	7.102E-01
2694	19.8	(°)	22.01	2.932E-06	-2.115E-03	7.102E-01
2695	16.8	15.6	21.07	2.932E-06	-2.115E-03	7.102E-01
2696	38.2	4.6	20.04	2.932E-06	-2.115E-03	7.102E-01
2697	35.3	53.2	19.82	2.932E-06	-2.115E-03	7.102E-01
2698	34.8	(°)	19.79	2.932E-06	-2.115E-03	7.102E-01
2699	28	(°)	18.28	2.932E-06	-2.115E-03	7.102E-01
2700	18.9	(°)	16.18	2.932E-06	-2.115E-03	7.102E-01
2701	40.1	12.9	14.95	2.932E-06	-2.115E-03	7.102E-01
2702	28.6	(°)	13.58	2.932E-06	-2.115E-03	7.102E-01
2703	16.4	(°)	11.53	2.932E-06	-2.115E-03	7.102E-01
2704	10.4	(°)	10.49	2.932E-06	-2.115E-03	7.102E-01
2705	33.4	9.5	10.27	2.932E-06	-2.115E-03	7.102E-01
2706	28.5	3.5	10.04	2.932E-06	-2.115E-03	7.102E-01
2707	29.1	14.7	10.11	9.772E-07	-7.048E-04	2.367E-01
2708	36.1	19.7	10.96	-9.772E-07	7.048E-04	-2.367E-01
2709	43.7	21.1	11.91	-2.932E-06	2.115E-03	-7.102E-01
2710	51.1	14.7	12.84	-2.932E-06	2.115E-03	-7.102E-01
2711	55.9	21.4	13.43	-2.932E-06	2.115E-03	-7.102E-01
2712	66.5	34.1	14.71	-2.932E-06	2.115E-03	-7.102E-01
2713	68.3	19.9	15.86	-2.932E-06	2.115E-03	-7.102E-01
2714	40.6	23.4	15.53	-2.932E-06	2.115E-03	-7.102E-01
2715	53.5	75.5	17.59	-2.932E-06	2.115E-03	-7.102E-01
2716	63.9	17.2	19.44	-2.932E-06	2.115E-03	-7.102E-01
2717	64.5	11.6	19.56	-2.932E-06	2.115E-03	-7.102E-01
2718	36.4	2.4	19.47	-2.932E-06	2.115E-03	-7.102E-01
2719	34.5	50	19.63	-2.932E-06	2.115E-03	-7.102E-01
2720	39.1	24	20.72	-2.932E-06	2.115E-03	-7.102E-01
2721	41.7	26.3	21.3	-2.932E-06	2.115E-03	-7.102E-01
2722	43.6	20.8	21.75	-2.932E-06	2.115E-03	-7.102E-01
2723	45.5	28.8	22.16	-2.932E-06	2.115E-03	-7.102E-01
2724	47.5	27.2	22.62	-2.932E-06	2.115E-03	-7.102E-01
2725	47.6	20.8	22.65	-2.932E-06	2.115E-03	-7.102E-01
2726	48.4	30.2	22.8	-2.932E-06	2.115E-03	-7.102E-01
2727	48.3	20.1	22.8	-2.932E-06	2.115E-03	-7.102E-01
2728	50.2	(°)	23.3	-9.772E-07	7.048E-04	-2.367E-01

2729	49.6	(°)	23.19	9.772E-07	-7.048E-04	2.367E-01
2730	46.6	(°)	22.46	2.932E-06	-2.115E-03	7.102E-01
2731	44.7	(°)	22.03	2.932E-06	-2.115E-03	7.102E-01
2732	43.1	(°)	21.67	2.932E-06	-2.115E-03	7.102E-01
2733	41.2	(°)	21.23	2.932E-06	-2.115E-03	7.102E-01
2734	40.1	1.5	20.97	2.932E-06	-2.115E-03	7.102E-01
2735	39.5	(°)	20.86	2.932E-06	-2.115E-03	7.102E-01
2736	37.2	(°)	20.33	2.932E-06	-2.115E-03	7.102E-01
2737	34.7	(°)	19.76	2.932E-06	-2.115E-03	7.102E-01
2738	29.9	(°)	18.71	2.932E-06	-2.115E-03	7.102E-01
2739	21.9	(°)	16.9	2.932E-06	-2.115E-03	7.102E-01
2740	27.2	14.2	14.92	2.932E-06	-2.115E-03	7.102E-01
2741	29.7	0.3	13.71	2.932E-06	-2.115E-03	7.102E-01
2742	24.4	(°)	12.88	2.932E-06	-2.115E-03	7.102E-01
2743	10.1	(°)	10.5	2.932E-06	-2.115E-03	7.102E-01
2744	10.4	(°)	7.5	2.932E-06	-2.115E-03	7.102E-01
2745	16.1	11.8	5.02	2.932E-06	-2.115E-03	7.102E-01
2746	16.5	9.6	3.25	2.932E-06	-2.115E-03	7.102E-01
2747	0	0	0.16	2.932E-06	-2.115E-03	7.102E-01
2748	0	0	0	2.932E-06	-2.115E-03	7.102E-01
2749	0	0	0	2.932E-06	-2.115E-03	7.102E-01
2750	0	0	0	2.537E-06	-2.528E-03	-2.959E-02
2751	0	0	0	2.143E-06	-2.941E-03	-7.694E-01
2752	0	0	0	1.749E-06	-3.354E-03	-1.509E+00
2754	0	0	0	1.749E-06	-3.354E-03	-1.509E+00
2755	5.6	23	0.1	1.749E-06	-3.354E-03	-1.509E+00
2756	19.9	33.9	2.7	1.749E-06	-3.354E-03	-1.509E+00
2757	74.4	32.9	4.69	1.749E-06	-3.354E-03	-1.509E+00
2758	60.9	1	5.72	1.749E-06	-3.354E-03	-1.509E+00
2759	97.8	33.1	7.34	1.749E-06	-3.354E-03	-1.509E+00
2760	55.9	2.2	7.4	1.749E-06	-3.354E-03	-1.509E+00
2761	89.4	50.7	9.63	1.749E-06	-3.354E-03	-1.509E+00
2762	54.9	1.2	9.81	1.749E-06	-3.354E-03	-1.509E+00
2763	71.2	57.1	11.41	1.749E-06	-3.354E-03	-1.509E+00
2764	90.9	17.2	13.4	1.749E-06	-3.354E-03	-1.509E+00
2765	55.2	0.8	13.37	1.749E-06	-3.354E-03	-1.509E+00
2766	75	77.5	15.71	1.749E-06	-3.354E-03	-1.509E+00
2767	85.3	20.8	17.87	1.749E-06	-3.354E-03	-1.509E+00
2768	52.8	13.4	17.59	1.749E-06	-3.354E-03	-1.509E+00
2769	65.9	80.7	19.67	1.749E-06	-3.354E-03	-1.509E+00
2770	85.7	74.1	22.96	1.749E-06	-3.354E-03	-1.509E+00
2771	53.9	0.2	23.66	1.749E-06	-3.354E-03	-1.509E+00
2772	55.1	62.4	24.3	1.749E-06	-3.354E-03	-1.509E+00
2773	65.1	77	26.51	1.749E-06	-3.354E-03	-1.509E+00
2774	77.2	83	29.24	1.749E-06	-3.354E-03	-1.509E+00
2775	51.1	6.5	29.99	1.749E-06	-3.354E-03	-1.509E+00
2776	46.7	52.1	30.18	1.749E-06	-3.354E-03	-1.509E+00
2777	51.7	78.3	31.64	1.749E-06	-3.354E-03	-1.509E+00
2778	58.5	62.4	33.74	1.749E-06	-3.354E-03	-1.509E+00
2779	60.8	33.9	34.5	1.749E-06	-3.354E-03	-1.509E+00
2780	62	48.1	34.83	1.749E-06	-3.354E-03	-1.509E+00
2781	65.4	41.7	35.89	1.749E-06	-3.354E-03	-1.509E+00
2782	67.2	23.3	36.47	1.749E-06	-3.354E-03	-1.509E+00
2783	68.2	10.3	37	1.749E-06	-3.354E-03	-1.509E+00
2784	36.5	3.2	36.85	1.749E-06	-3.354E-03	-1.509E+00
2785	36	7.7	36.65	1.749E-06	-3.354E-03	-1.509E+00
2786	36	27.9	36.64	1.749E-06	-3.354E-03	-1.509E+00
2787	36.5	14.5	36.86	1.749E-06	-3.354E-03	-1.509E+00
2788	35.9	(°)	36.64	1.749E-06	-3.354E-03	-1.509E+00
2789	34.7	(°)	36.15	1.749E-06	-3.354E-03	-1.509E+00
2790	33.3	(°)	35.59	1.749E-06	-3.354E-03	-1.509E+00
2791	32	(°)	35.04	1.749E-06	-3.354E-03	-1.509E+00
2792	30.6	(°)	34.44	1.749E-06	-3.354E-03	-1.509E+00
2793	29.2	(°)	33.85	1.749E-06	-3.354E-03	-1.509E+00
2794	29.2	39.4	33.79	1.749E-06	-3.354E-03	-1.509E+00
2795	30	(°)	34.16	1.749E-06	-3.354E-03	-1.509E+00
2796	30	36.7	34.11	1.749E-06	-3.354E-03	-1.509E+00
2797	32.3	24.1	35.11	1.749E-06	-3.354E-03	-1.509E+00
2798	33.2	37.9	35.47	1.749E-06	-3.354E-03	-1.509E+00
2799	33.8	53.5	35.68	1.749E-06	-3.354E-03	-1.509E+00
2800	35.7	53.5	36.45	1.749E-06	-3.354E-03	-1.509E+00
2801	36.9	29	37.02	1.749E-06	-3.354E-03	-1.509E+00

2802	37.2	26.9	37.15	1.749E-06	-3.354E-03	-1.509E+00
2803	37.8	1.8	37.44	1.749E-06	-3.354E-03	-1.509E+00
2804	37.4	17.4	37.25	1.749E-06	-3.354E-03	-1.509E+00
2805	37.4	9.8	37.26	1.749E-06	-3.354E-03	-1.509E+00
2806	37.6	16.8	37.3	1.749E-06	-3.354E-03	-1.509E+00
2807	38.5	36.7	37.66	1.749E-06	-3.354E-03	-1.509E+00
2808	38.8	0.3	37.86	1.749E-06	-3.354E-03	-1.509E+00
2809	39.5	( <sup>e</sup> )	38.14	1.749E-06	-3.354E-03	-1.509E+00
2810	40.2	( <sup>e</sup> )	38.46	1.749E-06	-3.354E-03	-1.509E+00
2811	41.3	38.9	38.82	1.749E-06	-3.354E-03	-1.509E+00
2812	42	59.2	39.1	1.749E-06	-3.354E-03	-1.509E+00
2813	42.8	83.1	39.37	1.749E-06	-3.354E-03	-1.509E+00
2814	44.5	93.3	40.07	1.749E-06	-3.354E-03	-1.509E+00
2815	45.6	19.9	40.66	1.749E-06	-3.354E-03	-1.509E+00
2816	46.3	40.8	40.89	5.830E-07	-1.118E-03	-5.031E-01
2817	45.6	( <sup>e</sup> )	40.72	-5.830E-07	1.118E-03	5.031E-01
2818	43.7	( <sup>e</sup> )	39.89	-1.749E-06	3.354E-03	1.509E+00
2819	42.4	10.3	39.33	-1.749E-06	3.354E-03	1.509E+00
2820	41.8	20	39.06	-1.749E-06	3.354E-03	1.509E+00
2821	41.6	36.9	38.94	-1.749E-06	3.354E-03	1.509E+00
2822	41	30.8	38.71	-1.749E-06	3.354E-03	1.509E+00
2823	38.3	( <sup>e</sup> )	37.68	-1.749E-06	3.354E-03	1.509E+00
2824	35.1	( <sup>e</sup> )	36.3	-1.749E-06	3.354E-03	1.509E+00
2825	32.5	5	35.22	-1.749E-06	3.354E-03	1.509E+00
2826	31.5	( <sup>e</sup> )	34.89	-1.749E-06	3.354E-03	1.509E+00
2827	29.4	( <sup>e</sup> )	34.01	-1.749E-06	3.354E-03	1.509E+00
2828	27.3	17.8	33.02	-1.749E-06	3.354E-03	1.509E+00
2829	26	( <sup>e</sup> )	32.53	-1.749E-06	3.354E-03	1.509E+00
2830	24.1	( <sup>e</sup> )	31.76	-1.749E-06	3.354E-03	1.509E+00
2831	21.2	2.8	30.51	-1.749E-06	3.354E-03	1.509E+00
2832	18.8	18.7	29.5	-1.749E-06	3.354E-03	1.509E+00
2833	17.5	( <sup>e</sup> )	28.98	-1.749E-06	3.354E-03	1.509E+00
2834	37.4	20.4	28.34	-1.749E-06	3.354E-03	1.509E+00
2835	36.9	( <sup>e</sup> )	27.3	-1.749E-06	3.354E-03	1.509E+00
2836	31.3	( <sup>e</sup> )	25.61	-1.749E-06	3.354E-03	1.509E+00
2837	25.4	( <sup>e</sup> )	23.8	-1.749E-06	3.354E-03	1.509E+00
2838	22.2	( <sup>e</sup> )	22.76	-1.749E-06	3.354E-03	1.509E+00
2839	20.2	( <sup>e</sup> )	22.13	-1.749E-06	3.354E-03	1.509E+00
2840	17.8	( <sup>e</sup> )	21.41	-1.749E-06	3.354E-03	1.509E+00
2841	39.4	19.9	20.54	-1.749E-06	3.354E-03	1.509E+00
2842	30.1	( <sup>e</sup> )	18.82	-1.749E-06	3.354E-03	1.509E+00
2843	23.8	( <sup>e</sup> )	17.32	-1.749E-06	3.354E-03	1.509E+00
2844	18	0.7	15.96	-1.749E-06	3.354E-03	1.509E+00
2845	40.1	10.2	14.79	-1.749E-06	3.354E-03	1.509E+00
2846	30.6	20.8	13.86	-1.749E-06	3.354E-03	1.509E+00
2847	26.2	( <sup>e</sup> )	13.15	-1.749E-06	3.354E-03	1.509E+00
2848	22.5	( <sup>e</sup> )	12.52	-1.749E-06	3.354E-03	1.509E+00
2849	20.6	( <sup>e</sup> )	12.22	-1.749E-06	3.354E-03	1.509E+00
2850	18.4	( <sup>e</sup> )	11.84	-1.749E-06	3.354E-03	1.509E+00
2851	17.5	( <sup>e</sup> )	11.7	-5.830E-07	1.118E-03	5.031E-01
2852	19	( <sup>e</sup> )	11.94	5.830E-07	-1.118E-03	-5.031E-01
2853	21.8	3.9	12.39	1.749E-06	-3.354E-03	-1.509E+00
2854	28.5	24.2	13.5	1.749E-06	-3.354E-03	-1.509E+00
2855	36.5	10	14.85	1.749E-06	-3.354E-03	-1.509E+00
2856	44.9	26	16.23	1.749E-06	-3.354E-03	-1.509E+00
2857	56.8	27.8	18.22	1.749E-06	-3.354E-03	-1.509E+00
2858	61.9	( <sup>e</sup> )	19.16	1.749E-06	-3.354E-03	-1.509E+00
2859	55.5	13.5	19.76	1.749E-06	-3.354E-03	-1.509E+00
2860	38.2	( <sup>e</sup> )	20.55	1.749E-06	-3.354E-03	-1.509E+00
2861	40.9	( <sup>e</sup> )	21.16	1.749E-06	-3.354E-03	-1.509E+00
2862	43.5	( <sup>e</sup> )	21.76	1.749E-06	-3.354E-03	-1.509E+00
2863	44.3	( <sup>e</sup> )	21.97	1.749E-06	-3.354E-03	-1.509E+00
2864	41.6	( <sup>e</sup> )	21.39	1.749E-06	-3.354E-03	-1.509E+00
2865	39.5	( <sup>e</sup> )	20.87	1.749E-06	-3.354E-03	-1.509E+00
2866	37.3	( <sup>e</sup> )	20.39	1.749E-06	-3.354E-03	-1.509E+00
2867	37	( <sup>e</sup> )	20.28	1.749E-06	-3.354E-03	-1.509E+00
2868	37.4	( <sup>e</sup> )	20.38	1.749E-06	-3.354E-03	-1.509E+00
2869	37.7	( <sup>e</sup> )	20.44	1.749E-06	-3.354E-03	-1.509E+00
2870	38.8	( <sup>e</sup> )	20.69	1.749E-06	-3.354E-03	-1.509E+00
2871	39	( <sup>e</sup> )	20.75	1.749E-06	-3.354E-03	-1.509E+00
2872	38.5	( <sup>e</sup> )	20.63	1.749E-06	-3.354E-03	-1.509E+00
2873	38.5	( <sup>e</sup> )	20.63	1.749E-06	-3.354E-03	-1.509E+00

2874	38.7	(°)	20.67	1.749E-06	-3.354E-03	-1.509E+00
2875	38.6	(°)	20.64	1.749E-06	-3.354E-03	-1.509E+00
2876	41	7.9	21.18	1.749E-06	-3.354E-03	-1.509E+00
2877	41.1	(°)	21.21	1.749E-06	-3.354E-03	-1.509E+00
2878	42.5	18.9	21.5	1.749E-06	-3.354E-03	-1.509E+00
2879	46.9	37.1	22.46	1.749E-06	-3.354E-03	-1.509E+00
2880	54	59.6	24.02	1.749E-06	-3.354E-03	-1.509E+00
2881	59.1	32.2	25.23	1.749E-06	-3.354E-03	-1.509E+00
2882	64.1	48.6	26.33	1.749E-06	-3.354E-03	-1.509E+00
2883	71.8	61.2	28.08	1.749E-06	-3.354E-03	-1.509E+00
2884	88.5	48.4	30.11	1.749E-06	-3.354E-03	-1.509E+00
2885	46.5	2.9	29.79	1.749E-06	-3.354E-03	-1.509E+00
2886	47.6	80.3	30.43	1.749E-06	-3.354E-03	-1.509E+00
2887	53.5	84.4	32.17	1.749E-06	-3.354E-03	-1.509E+00
2888	60.7	91.2	34.34	1.749E-06	-3.354E-03	-1.509E+00
2889	68	89.5	36.57	1.749E-06	-3.354E-03	-1.509E+00
2890	83.8	30	38.16	1.749E-06	-3.354E-03	-1.509E+00
2891	38.8	3.1	37.86	1.749E-06	-3.354E-03	-1.509E+00
2892	40.5	84.5	38.44	1.749E-06	-3.354E-03	-1.509E+00
2893	43.8	87.5	39.75	1.749E-06	-3.354E-03	-1.509E+00
2894	47.6	94.8	41.35	1.749E-06	-3.354E-03	-1.509E+00
2895	51.6	97.2	43.01	1.749E-06	-3.354E-03	-1.509E+00
2896	55.2	89.3	44.52	1.749E-06	-3.354E-03	-1.509E+00
2897	57.4	71.7	45.47	1.749E-06	-3.354E-03	-1.509E+00
2898	59.1	71.9	46.15	1.749E-06	-3.354E-03	-1.509E+00
2899	61	85.6	46.91	8.186E-08	-1.400E-03	-1.640E+00
2900	62.4	77.7	47.54	-1.585E-06	5.535E-04	-1.771E+00
2901	63.3	66.2	47.93	-3.252E-06	2.507E-03	-1.901E+00
2902	63.7	57.5	48.09	-3.252E-06	2.507E-03	-1.901E+00
2903	64.8	12.5	48.73	-3.252E-06	2.507E-03	-1.901E+00
2904	36.2	0.2	48.99	-3.252E-06	2.507E-03	-1.901E+00
2905	36.1	40.1	48.91	-3.252E-06	2.507E-03	-1.901E+00
2906	36.4	53.8	49.02	-3.252E-06	2.507E-03	-1.901E+00
2907	37.2	62.7	49.46	-3.252E-06	2.507E-03	-1.901E+00
2908	38.3	67.1	50.09	-3.252E-06	2.507E-03	-1.901E+00
2909	39.6	51.8	50.81	-3.252E-06	2.507E-03	-1.901E+00
2910	40.1	54.1	51.09	-3.252E-06	2.507E-03	-1.901E+00
2911	40.1	34.6	51.12	-3.252E-06	2.507E-03	-1.901E+00
2912	39.8	40.2	50.96	-3.252E-06	2.507E-03	-1.901E+00
2913	40.8	56.1	51.48	-3.252E-06	2.507E-03	-1.901E+00
2914	40.3	37.3	51.21	-3.252E-06	2.507E-03	-1.901E+00
2915	40.6	45.8	51.36	-3.252E-06	2.507E-03	-1.901E+00
2916	40.6	(°)	51.47	-3.252E-06	2.507E-03	-1.901E+00
2917	40	11.8	51.13	-3.252E-06	2.507E-03	-1.901E+00
2918	40.1	18.5	51.14	-3.252E-06	2.507E-03	-1.901E+00
2919	39.2	25.2	50.64	-3.252E-06	2.507E-03	-1.901E+00
2920	38.8	40.6	50.38	-3.252E-06	2.507E-03	-1.901E+00
2921	39	38.4	50.51	-3.252E-06	2.507E-03	-1.901E+00
2922	39	40	50.51	-3.252E-06	2.507E-03	-1.901E+00
2923	38.6	71.7	50.24	-3.252E-06	2.507E-03	-1.901E+00
2924	38.9	89.2	50.37	-3.252E-06	2.507E-03	-1.901E+00
2925	40.1	18.1	51.15	-3.252E-06	2.507E-03	-1.901E+00
2926	40.5	(°)	51.42	-3.252E-06	2.507E-03	-1.901E+00
2927	40.5	(°)	51.4	-1.084E-06	8.357E-04	-6.338E-01
2928	40.1	(°)	51.2	1.084E-06	-8.357E-04	6.338E-01
2929	38.6	(°)	50.4	3.252E-06	-2.507E-03	1.901E+00
2930	36.9	(°)	49.46	3.252E-06	-2.507E-03	1.901E+00
2931	35.6	(°)	48.7	3.252E-06	-2.507E-03	1.901E+00
2932	34.3	(°)	47.97	3.252E-06	-2.507E-03	1.901E+00
2933	33.2	(°)	47.36	3.252E-06	-2.507E-03	1.901E+00
2934	32.4	7.6	46.87	3.252E-06	-2.507E-03	1.901E+00
2935	32.2	(°)	46.78	3.252E-06	-2.507E-03	1.901E+00
2936	31.3	30.2	46.25	3.252E-06	-2.507E-03	1.901E+00
2937	31.9	21.1	46.58	3.252E-06	-2.507E-03	1.901E+00
2938	31.2	8.6	46.21	3.252E-06	-2.507E-03	1.901E+00
2939	31.2	34.6	46.2	3.252E-06	-2.507E-03	1.901E+00
2940	31.4	5.8	46.33	3.252E-06	-2.507E-03	1.901E+00
2941	30.6	(°)	45.9	3.252E-06	-2.507E-03	1.901E+00
2942	29.8	(°)	45.44	3.252E-06	-2.507E-03	1.901E+00
2943	29.4	37.9	45.2	3.252E-06	-2.507E-03	1.901E+00
2944	30.2	66.9	45.55	3.252E-06	-2.507E-03	1.901E+00
2945	30.9	44.1	46.01	3.252E-06	-2.507E-03	1.901E+00



2946	31.1	35.5	46.15	3.252E-06	-2.507E-03	1.901E+00
2947	31.1	9.2	46.18	3.252E-06	-2.507E-03	1.901E+00
2948	30.4	20.2	45.75	3.252E-06	-2.507E-03	1.901E+00
2949	30.5	38.2	45.79	3.252E-06	-2.507E-03	1.901E+00
2950	31	51.1	46.04	3.252E-06	-2.507E-03	1.901E+00
2951	32.1	79.8	46.62	3.252E-06	-2.507E-03	1.901E+00
2952	32.8	30.1	47.1	3.252E-06	-2.507E-03	1.901E+00
2953	32.1	0.1	46.75	3.252E-06	-2.507E-03	1.901E+00
2954	31.2	(°)	46.21	3.252E-06	-2.507E-03	1.901E+00
2955	30.1	(°)	45.66	3.252E-06	-2.507E-03	1.901E+00
2956	29	(°)	45.04	3.252E-06	-2.507E-03	1.901E+00
2957	28.1	0.8	44.54	3.252E-06	-2.507E-03	1.901E+00
2958	28	19.9	44.41	3.252E-06	-2.507E-03	1.901E+00
2959	27.8	22	44.32	3.252E-06	-2.507E-03	1.901E+00
2960	27.4	(°)	44.13	3.252E-06	-2.507E-03	1.901E+00
2961	26.2	(°)	43.49	3.252E-06	-2.507E-03	1.901E+00
2962	25.3	(°)	42.96	3.252E-06	-2.507E-03	1.901E+00
2963	24.7	14.5	42.59	3.252E-06	-2.507E-03	1.901E+00
2964	24.4	34.1	42.43	3.252E-06	-2.507E-03	1.901E+00
2965	24.6	47.9	42.51	3.252E-06	-2.507E-03	1.901E+00
2966	25	59.8	42.68	3.252E-06	-2.507E-03	1.901E+00
2967	25	57.9	42.7	3.252E-06	-2.507E-03	1.901E+00
2968	24.6	66.1	42.5	3.252E-06	-2.507E-03	1.901E+00
2969	24	22.9	42.21	3.252E-06	-2.507E-03	1.901E+00
2970	21.8	40	40.98	3.252E-06	-2.507E-03	1.901E+00
2971	21.7	68.7	40.86	3.252E-06	-2.507E-03	1.901E+00
2972	22.8	(°)	41.59	3.252E-06	-2.507E-03	1.901E+00
2973	21.1	(°)	40.72	3.252E-06	-2.507E-03	1.901E+00
2974	18.3	(°)	39.16	3.252E-06	-2.507E-03	1.901E+00
2975	20.6	10.1	38.09	3.252E-06	-2.507E-03	1.901E+00
2976	40.2	3.7	37.78	1.084E-06	-8.357E-04	6.338E-01
2977	39.6	62.7	38.09	-1.084E-06	8.357E-04	-6.338E-01
2978	41.5	38.1	38.92	-3.252E-06	2.507E-03	-1.901E+00
2979	41.8	11.7	39.06	-3.252E-06	2.507E-03	-1.901E+00
2980	41.6	(°)	39.04	-3.252E-06	2.507E-03	-1.901E+00
2981	39.9	(°)	38.34	-3.252E-06	2.507E-03	-1.901E+00
2982	38.9	(°)	37.87	-3.252E-06	2.507E-03	-1.901E+00
2983	38.2	12.5	37.57	-3.252E-06	2.507E-03	-1.901E+00
2984	37.8	27	37.4	-3.252E-06	2.507E-03	-1.901E+00
2985	38.3	25.4	37.6	-3.252E-06	2.507E-03	-1.901E+00
2986	39	21	37.9	-3.252E-06	2.507E-03	-1.901E+00
2987	39.9	17.6	38.29	-3.252E-06	2.507E-03	-1.901E+00
2988	40.7	36.7	38.56	-3.252E-06	2.507E-03	-1.901E+00
2989	41.1	47.3	38.74	-3.252E-06	2.507E-03	-1.901E+00
2990	40.5	34.5	38.48	-3.252E-06	2.507E-03	-1.901E+00
2991	40.6	3.8	38.57	-3.252E-06	2.507E-03	-1.901E+00
2992	40.2	(°)	38.45	-3.252E-06	2.507E-03	-1.901E+00
2993	40	(°)	38.35	-3.252E-06	2.507E-03	-1.901E+00
2994	40.4	18.4	38.47	-3.252E-06	2.507E-03	-1.901E+00
2995	41.7	30.6	39	-3.252E-06	2.507E-03	-1.901E+00
2996	42.6	27.8	39.37	-3.252E-06	2.507E-03	-1.901E+00
2997	43.4	18.8	39.73	-3.252E-06	2.507E-03	-1.901E+00
2998	43.2	15.5	39.66	-3.252E-06	2.507E-03	-1.901E+00
2999	43.5	21.1	39.76	-2.595E-06	1.697E-03	-2.144E+00
3000	43.9	16.5	39.95	-1.937E-06	8.875E-04	-2.387E+00
3001	44.1	11	40.03	-1.279E-06	7.771E-05	-2.629E+00
3002	43.6	0.9	39.83	-1.279E-06	7.771E-05	-2.629E+00
3003	42.8	2.5	39.49	-1.279E-06	7.771E-05	-2.629E+00
3004	42.4	31.4	39.28	-1.279E-06	7.771E-05	-2.629E+00
3005	43.2	48.8	39.59	-1.279E-06	7.771E-05	-2.629E+00
3006	44.3	39.9	40.05	-1.279E-06	7.771E-05	-2.629E+00
3007	44.9	41.2	40.32	-1.279E-06	7.771E-05	-2.629E+00
3008	45.2	46.6	40.41	-1.279E-06	7.771E-05	-2.629E+00
3009	45.7	53.4	40.63	-1.279E-06	7.771E-05	-2.629E+00
3010	46.7	44.3	41.06	-1.279E-06	7.771E-05	-2.629E+00
3011	47.4	40.7	41.35	-1.279E-06	7.771E-05	-2.629E+00
3012	47.7	21.3	41.53	-1.279E-06	7.771E-05	-2.629E+00
3013	46.5	10.7	41.02	-1.279E-06	7.771E-05	-2.629E+00
3014	45.9	14	40.8	-1.279E-06	7.771E-05	-2.629E+00
3015	45.5	12.2	40.6	-1.279E-06	7.771E-05	-2.629E+00
3016	45.4	9.7	40.57	-1.279E-06	7.771E-05	-2.629E+00
3017	45	8.3	40.43	-1.279E-06	7.771E-05	-2.629E+00

3018	44.3	37.6	40.07	-1.279E-06	7.771E-05	-2.629E+00
3019	43.8	63.1	39.82	-1.279E-06	7.771E-05	-2.629E+00
3020	44.9	85.9	40.24	-1.279E-06	7.771E-05	-2.629E+00
3021	48.1	94.1	41.54	-1.279E-06	7.771E-05	-2.629E+00
3022	51	50.2	42.85	-1.279E-06	7.771E-05	-2.629E+00
3023	52.9	22.7	43.67	-1.279E-06	7.771E-05	-2.629E+00
3024	53.3	0.9	43.88	-1.279E-06	7.771E-05	-2.629E+00
3025	52.8	3.9	43.66	-1.279E-06	7.771E-05	-2.629E+00
3026	52.1	(°)	43.4	-1.279E-06	7.771E-05	-2.629E+00
3027	51.5	(°)	43.16	-1.279E-06	7.771E-05	-2.629E+00
3028	50.8	(°)	42.86	-1.279E-06	7.771E-05	-2.629E+00
3029	49.9	(°)	42.45	-1.279E-06	7.771E-05	-2.629E+00
3030	48.4	20.6	41.79	-1.279E-06	7.771E-05	-2.629E+00
3031	47.7	33.2	41.51	-1.279E-06	7.771E-05	-2.629E+00
3032	48.2	1.7	41.74	-1.279E-06	7.771E-05	-2.629E+00
3033	48.7	(°)	42.03	-1.279E-06	7.771E-05	-2.629E+00
3034	47.7	(°)	41.57	-1.279E-06	7.771E-05	-2.629E+00
3035	45.6	38.3	40.62	-1.279E-06	7.771E-05	-2.629E+00
3036	45.8	49.5	40.69	-1.279E-06	7.771E-05	-2.629E+00
3037	47	(°)	41.29	-1.279E-06	7.771E-05	-2.629E+00
3038	47.1	6.7	41.29	-1.279E-06	7.771E-05	-2.629E+00
3039	46.7	12.3	41.12	-1.279E-06	7.771E-05	-2.629E+00
3040	46.4	20.6	40.99	-1.279E-06	7.771E-05	-2.629E+00
3041	46.6	32.4	41.02	-1.279E-06	7.771E-05	-2.629E+00
3042	47.3	11.8	41.34	-1.279E-06	7.771E-05	-2.629E+00
3043	46.3	(°)	41	-1.279E-06	7.771E-05	-2.629E+00
3044	44.9	(°)	40.4	-1.279E-06	7.771E-05	-2.629E+00
3045	43.6	15.7	39.84	-1.279E-06	7.771E-05	-2.629E+00
3046	44	29.1	39.95	-1.279E-06	7.771E-05	-2.629E+00
3047	44.4	17.1	40.16	-1.279E-06	7.771E-05	-2.629E+00
3048	44.8	23	40.3	-1.279E-06	7.771E-05	-2.629E+00
3049	44.9	21.9	40.35	-1.279E-06	7.771E-05	-2.629E+00
3050	45.1	21.5	40.44	-1.279E-06	7.771E-05	-2.629E+00
3051	44.8	36.8	40.28	-1.279E-06	7.771E-05	-2.629E+00
3052	44.8	40	40.29	-1.279E-06	7.771E-05	-2.629E+00
3053	45.4	8.4	40.57	-1.279E-06	7.771E-05	-2.629E+00
3054	44.5	22.7	40.19	-1.279E-06	7.771E-05	-2.629E+00
3055	44	43	39.92	-1.279E-06	7.771E-05	-2.629E+00
3056	45.2	16.5	40.48	-1.279E-06	7.771E-05	-2.629E+00
3057	45.5	(°)	40.62	-1.279E-06	7.771E-05	-2.629E+00
3058	45	4	40.43	-4.265E-07	2.590E-05	-8.763E-01
3059	47	12.5	41.24	4.265E-07	-2.590E-05	8.763E-01
3060	45.8	(°)	40.82	1.279E-06	-7.771E-05	2.629E+00
3061	45.6	(°)	40.72	1.279E-06	-7.771E-05	2.629E+00
3062	45.2	(°)	40.56	1.279E-06	-7.771E-05	2.629E+00
3063	44.2	(°)	40.13	1.279E-06	-7.771E-05	2.629E+00
3064	42.6	(°)	39.45	1.279E-06	-7.771E-05	2.629E+00
3065	41.2	(°)	38.88	1.279E-06	-7.771E-05	2.629E+00
3066	39.6	(°)	38.22	1.279E-06	-7.771E-05	2.629E+00
3067	37.3	(°)	37.22	1.279E-06	-7.771E-05	2.629E+00
3068	35.6	(°)	36.53	1.279E-06	-7.771E-05	2.629E+00
3069	34.6	(°)	36.11	1.279E-06	-7.771E-05	2.629E+00
3070	33.4	(°)	35.63	1.279E-06	-7.771E-05	2.629E+00
3071	31.9	(°)	34.99	1.279E-06	-7.771E-05	2.629E+00
3072	29.8	(°)	34.12	1.279E-06	-7.771E-05	2.629E+00
3073	28.2	2.7	33.44	1.279E-06	-7.771E-05	2.629E+00
3074	28.7	25	33.59	1.279E-06	-7.771E-05	2.629E+00
3075	28	(°)	33.36	1.279E-06	-7.771E-05	2.629E+00
3076	27.2	(°)	33.07	1.279E-06	-7.771E-05	2.629E+00
3077	24.8	(°)	32.09	1.279E-06	-7.771E-05	2.629E+00
3078	21.8	(°)	30.8	1.279E-06	-7.771E-05	2.629E+00
3079	19.5	(°)	29.84	1.279E-06	-7.771E-05	2.629E+00
3080	17.4	(°)	28.96	1.279E-06	-7.771E-05	2.629E+00
3081	41.9	19.2	28.16	1.279E-06	-7.771E-05	2.629E+00
3082	38	(°)	27.61	1.279E-06	-7.771E-05	2.629E+00
3083	35.2	(°)	26.78	1.279E-06	-7.771E-05	2.629E+00
3084	31.2	(°)	25.54	1.279E-06	-7.771E-05	2.629E+00
3085	27.6	3	24.41	1.279E-06	-7.771E-05	2.629E+00
3086	29.3	42.9	24.87	1.279E-06	-7.771E-05	2.629E+00
3087	29.7	38.8	24.98	1.279E-06	-7.771E-05	2.629E+00
3088	27	(°)	24.23	1.279E-06	-7.771E-05	2.629E+00
3089	25.1	(°)	23.7	1.279E-06	-7.771E-05	2.629E+00

3090	20	(°)	22.18	1.279E-06	-7.771E-05	2.629E+00
3091	34.3	15.3	19.97	1.279E-06	-7.771E-05	2.629E+00
3092	25.8	(°)	17.8	1.279E-06	-7.771E-05	2.629E+00
3093	22.1	(°)	16.89	1.279E-06	-7.771E-05	2.629E+00
3094	20.7	(°)	16.57	1.279E-06	-7.771E-05	2.629E+00
3095	19	(°)	16.19	1.279E-06	-7.771E-05	2.629E+00
3096	34	17.2	15.05	1.279E-06	-7.771E-05	2.629E+00
3097	26.1	1.2	13.21	1.279E-06	-7.771E-05	2.629E+00
3098	11.7	7.9	8.67	1.279E-06	-7.771E-05	2.629E+00
3099	14.6	7.5	4.71	1.279E-06	-7.771E-05	2.629E+00
3100	2.1	0.3	2.23	1.279E-06	-7.771E-05	2.629E+00
3101	0.1	2.1	0.64	4.265E-07	-2.590E-05	8.763E-01
3102	0	0	0	-4.265E-07	2.590E-05	-8.763E-01
3103	0	0	0	-1.279E-06	7.771E-05	-2.629E+00
3124	0	0	0	-1.279E-06	7.771E-05	-2.629E+00
3125	0.6	10.4	0.19	-1.279E-06	7.771E-05	-2.629E+00
3126	7.6	32.5	1.28	-1.279E-06	7.771E-05	-2.629E+00
3127	14.8	14.4	2.8	-1.279E-06	7.771E-05	-2.629E+00
3128	33.9	8.5	3.61	-1.279E-06	7.771E-05	-2.629E+00
3129	57.6	11.5	4.62	-1.279E-06	7.771E-05	-2.629E+00
3130	66.3	12.2	5.82	-1.279E-06	7.771E-05	-2.629E+00
3131	71.7	30.5	6.74	-1.279E-06	7.771E-05	-2.629E+00
3132	44.1	5.8	8.12	-1.279E-06	7.771E-05	-2.629E+00
3133	53.4	37.5	9.38	-1.279E-06	7.771E-05	-2.629E+00
3134	106.1	78.9	13.44	-1.279E-06	7.771E-05	-2.629E+00
3135	43.8	1.9	13.76	-1.279E-06	7.771E-05	-2.629E+00
3136	60	59.6	16.08	-1.279E-06	7.771E-05	-2.629E+00
3137	90.4	70.2	20.49	-1.279E-06	7.771E-05	-2.629E+00
3138	62.1	1.8	20.87	-1.279E-06	7.771E-05	-2.629E+00
3139	71.3	61.6	22.66	-1.279E-06	7.771E-05	-2.629E+00
3140	85.2	26.5	25.16	-1.279E-06	7.771E-05	-2.629E+00
3141	54.6	20.2	25.48	-1.279E-06	7.771E-05	-2.629E+00
3142	64.1	71.4	27.67	-1.279E-06	7.771E-05	-2.629E+00
3143	76.1	46.3	30.65	-1.279E-06	7.771E-05	-2.629E+00
3144	51.8	0.8	31.12	-1.279E-06	7.771E-05	-2.629E+00
3145	50.9	(°)	31.4	-1.279E-06	7.771E-05	-2.629E+00
3146	51.3	(°)	31.52	-1.279E-06	7.771E-05	-2.629E+00
3147	51.6	(°)	31.63	-1.279E-06	7.771E-05	-2.629E+00
3148	51.9	(°)	31.73	-1.279E-06	7.771E-05	-2.629E+00
3149	51.9	(°)	31.71	-1.279E-06	7.771E-05	-2.629E+00
3150	51.4	(°)	31.57	-1.279E-06	7.771E-05	-2.629E+00
3151	50.2	(°)	31.23	-1.279E-06	7.771E-05	-2.629E+00
3152	48.6	(°)	30.73	-1.279E-06	7.771E-05	-2.629E+00
3153	47.3	(°)	30.3	-1.279E-06	7.771E-05	-2.629E+00
3154	47.1	(°)	30.21	-1.279E-06	7.771E-05	-2.629E+00
3155	47.9	4.9	30.46	-1.279E-06	7.771E-05	-2.629E+00
3156	49.6	14	30.96	-1.279E-06	7.771E-05	-2.629E+00
3157	52.5	26	31.86	-1.279E-06	7.771E-05	-2.629E+00
3158	54.8	14.1	32.6	-1.279E-06	7.771E-05	-2.629E+00
3159	56.1	5.8	33.02	-1.279E-06	7.771E-05	-2.629E+00
3160	57	3.4	33.28	-1.279E-06	7.771E-05	-2.629E+00
3161	57.9	5.5	33.57	-1.279E-06	7.771E-05	-2.629E+00
3162	58	7.5	33.87	-1.279E-06	7.771E-05	-2.629E+00
3163	34.6	(°)	33.8	-1.279E-06	7.771E-05	-2.629E+00
3164	34.3	(°)	33.67	-1.279E-06	7.771E-05	-2.629E+00
3165	34.2	20.5	33.61	-1.279E-06	7.771E-05	-2.629E+00
3166	34.8	25.1	33.83	-1.279E-06	7.771E-05	-2.629E+00
3167	35.3	24.8	34.04	-1.279E-06	7.771E-05	-2.629E+00
3168	36.1	30.5	34.35	-1.279E-06	7.771E-05	-2.629E+00
3169	37.2	32.4	34.77	-3.252E-07	-6.690E-04	-2.393E+00
3170	38.1	28.6	35.16	6.290E-07	-1.416E-03	-2.157E+00
3171	38.8	25.7	35.44	1.583E-06	-2.162E-03	-1.921E+00
3172	39.5	26.4	35.7	1.583E-06	-2.162E-03	-1.921E+00
3173	40.2	27	36	1.583E-06	-2.162E-03	-1.921E+00
3174	40.9	23.3	36.27	1.583E-06	-2.162E-03	-1.921E+00
3175	41.2	21.8	36.4	1.583E-06	-2.162E-03	-1.921E+00
3176	42	32.6	36.67	1.583E-06	-2.162E-03	-1.921E+00
3177	43.4	41.2	37.21	1.583E-06	-2.162E-03	-1.921E+00
3178	46.2	74.3	38.28	1.583E-06	-2.162E-03	-1.921E+00
3179	50.5	90.2	39.97	1.583E-06	-2.162E-03	-1.921E+00
3180	53.9	41.2	41.41	1.583E-06	-2.162E-03	-1.921E+00
3181	54.1	13.4	41.56	5.277E-07	-7.208E-04	-6.402E-01

3182	53.5	(°)	41.33	-5.277E-07	7.208E-04	6.402E-01
3183	51.9	(°)	40.72	-1.583E-06	2.162E-03	1.921E+00
3184	50.3	(°)	40.07	-1.583E-06	2.162E-03	1.921E+00
3185	48.4	(°)	39.34	-1.583E-06	2.162E-03	1.921E+00
3186	47	(°)	38.75	-1.583E-06	2.162E-03	1.921E+00
3187	46	(°)	38.34	-1.583E-06	2.162E-03	1.921E+00
3188	44.6	(°)	37.79	-1.583E-06	2.162E-03	1.921E+00
3189	42.5	(°)	37.02	-1.583E-06	2.162E-03	1.921E+00
3190	38.1	(°)	35.28	-1.583E-06	2.162E-03	1.921E+00
3191	35.1	(°)	34.03	-1.583E-06	2.162E-03	1.921E+00
3192	33	(°)	33.19	-1.583E-06	2.162E-03	1.921E+00
3193	31.5	(°)	32.55	-1.583E-06	2.162E-03	1.921E+00
3194	30.8	11.8	32.27	-1.583E-06	2.162E-03	1.921E+00
3195	30.8	15.6	32.23	-1.583E-06	2.162E-03	1.921E+00
3196	30.6	(°)	32.19	-1.583E-06	2.162E-03	1.921E+00
3197	28	(°)	31.26	-1.583E-06	2.162E-03	1.921E+00
3198	21.4	(°)	28.69	-1.583E-06	2.162E-03	1.921E+00
3199	33.8	6	25.33	-1.583E-06	2.162E-03	1.921E+00
3200	20.7	(°)	22.12	-1.583E-06	2.162E-03	1.921E+00
3201	32	8.3	19.64	-1.583E-06	2.162E-03	1.921E+00
3202	24	(°)	18.09	-1.583E-06	2.162E-03	1.921E+00
3203	19.9	(°)	17.06	-1.583E-06	2.162E-03	1.921E+00
3204	40.2	16.1	16.91	-1.583E-06	2.162E-03	1.921E+00
3205	43.3	26	17.48	-1.583E-06	2.162E-03	1.921E+00
3206	49.5	24.1	18.65	-1.583E-06	2.162E-03	1.921E+00
3207	52.6	16.2	19.24	-1.583E-06	2.162E-03	1.921E+00
3208	56.1	16.8	19.91	-1.583E-06	2.162E-03	1.921E+00
3209	57.4	1.5	20.18	-1.583E-06	2.162E-03	1.921E+00
3210	54.3	(°)	19.61	-1.583E-06	2.162E-03	1.921E+00
3211	51	(°)	18.99	-1.583E-06	2.162E-03	1.921E+00
3212	47.8	(°)	18.39	-1.583E-06	2.162E-03	1.921E+00
3213	44.7	(°)	17.8	-1.583E-06	2.162E-03	1.921E+00
3214	41	(°)	17.12	-1.583E-06	2.162E-03	1.921E+00
3215	37.3	(°)	16.42	-1.583E-06	2.162E-03	1.921E+00
3216	31.4	(°)	15.33	-1.583E-06	2.162E-03	1.921E+00
3217	20.8	(°)	13.35	-1.583E-06	2.162E-03	1.921E+00
3218	34.5	10.9	12.3	-1.583E-06	2.162E-03	1.921E+00
3219	29	(°)	11.67	-1.583E-06	2.162E-03	1.921E+00
3220	22.3	(°)	10.68	-1.583E-06	2.162E-03	1.921E+00
3221	13.8	(°)	9.44	-1.583E-06	2.162E-03	1.921E+00
3222	21.9	6.8	8.17	-1.583E-06	2.162E-03	1.921E+00
3223	16.8	6.7	7.78	-1.583E-06	2.162E-03	1.921E+00
3224	18.1	12.5	7.93	-1.583E-06	2.162E-03	1.921E+00
3225	19.5	9.6	8.1	-1.583E-06	2.162E-03	1.921E+00
3226	20.9	10.3	8.26	-1.583E-06	2.162E-03	1.921E+00
3227	21.1	4.8	8.28	-1.583E-06	2.162E-03	1.921E+00
3228	16.2	(°)	7.74	-1.583E-06	2.162E-03	1.921E+00
3229	19.6	9.3	6.1	-1.583E-06	2.162E-03	1.921E+00
3230	13.5	1.1	4.38	-1.583E-06	2.162E-03	1.921E+00
3231	18.2	(°)	3.83	-1.583E-06	2.162E-03	1.921E+00
3232	13.9	6.2	3.58	-5.277E-07	7.208E-04	6.402E-01
3233	20.5	14.6	3.94	5.277E-07	-7.208E-04	-6.402E-01
3234	33.4	9.2	4.66	1.583E-06	-2.162E-03	-1.921E+00
3235	43.5	8	5.23	1.583E-06	-2.162E-03	-1.921E+00
3236	54.4	8.7	5.84	1.583E-06	-2.162E-03	-1.921E+00
3237	66.2	9.2	6.5	1.583E-06	-2.162E-03	-1.921E+00
3238	43.1	1	6.49	1.583E-06	-2.162E-03	-1.921E+00
3239	54	16.4	7.41	1.583E-06	-2.162E-03	-1.921E+00
3240	69.3	13.6	8.51	1.583E-06	-2.162E-03	-1.921E+00
3241	65.5	13.2	8.99	1.583E-06	-2.162E-03	-1.921E+00
3242	50	26.4	9.1	1.583E-06	-2.162E-03	-1.921E+00
3243	62.2	8.9	10.26	1.583E-06	-2.162E-03	-1.921E+00
3244	60.4	4.5	10.19	1.583E-06	-2.162E-03	-1.921E+00
3245	33.7	(°)	9.77	1.583E-06	-2.162E-03	-1.921E+00
3246	27.5	(°)	9.05	1.583E-06	-2.162E-03	-1.921E+00
3247	16.4	(°)	7.78	1.583E-06	-2.162E-03	-1.921E+00
3248	23.9	6.8	6.52	1.583E-06	-2.162E-03	-1.921E+00
3249	13.5	(°)	5.82	2.099E-06	-3.681E-03	-1.983E+00
3250	21.9	1	4.99	2.615E-06	-5.199E-03	-2.046E+00
3251	15.2	8.3	4.66	3.131E-06	-6.718E-03	-2.109E+00
3252	24.2	16.5	5.29	3.131E-06	-6.718E-03	-2.109E+00
3253	35.3	10.4	6.09	3.131E-06	-6.718E-03	-2.109E+00

3254	41.6	5.6	6.54	3.131E-06	-6.718E-03	-2.109E+00
3255	39.6	(°)	6.41	3.131E-06	-6.718E-03	-2.109E+00
3256	37.9	3.5	6.29	3.131E-06	-6.718E-03	-2.109E+00
3257	40.2	5.7	6.44	3.131E-06	-6.718E-03	-2.109E+00
3258	43.8	5.7	6.7	3.131E-06	-6.718E-03	-2.109E+00
3259	47	5.1	6.93	3.131E-06	-6.718E-03	-2.109E+00
3260	51.7	7.4	7.26	3.131E-06	-6.718E-03	-2.109E+00
3261	60.2	10.7	7.86	3.131E-06	-6.718E-03	-2.109E+00
3262	69.7	10	8.54	3.131E-06	-6.718E-03	-2.109E+00
3263	45	0.1	8.49	3.131E-06	-6.718E-03	-2.109E+00
3264	37	(°)	7.97	3.131E-06	-6.718E-03	-2.109E+00
3265	29.3	(°)	7.28	3.131E-06	-6.718E-03	-2.109E+00
3266	20.4	(°)	6.46	3.131E-06	-6.718E-03	-2.109E+00
3267	12.8	(°)	5.76	3.131E-06	-6.718E-03	-2.109E+00
3268	30.2	4.2	5.62	3.131E-06	-6.718E-03	-2.109E+00
3269	45.6	23.4	6.79	3.131E-06	-6.718E-03	-2.109E+00
3270	66.8	15.6	8.32	1.044E-06	-2.239E-03	-7.030E-01
3271	77.2	13.6	9.08	-1.044E-06	2.239E-03	7.030E-01
3272	48.2	2.2	8.93	-3.131E-06	6.718E-03	2.109E+00
3273	41.3	(°)	8.38	-3.131E-06	6.718E-03	2.109E+00
3274	33.5	(°)	7.66	-3.131E-06	6.718E-03	2.109E+00
3275	26	(°)	6.97	-3.131E-06	6.718E-03	2.109E+00
3276	18.7	(°)	6.3	-3.131E-06	6.718E-03	2.109E+00
3277	12.2	0.2	5.74	-3.131E-06	6.718E-03	2.109E+00
3278	20.9	(°)	4.92	-3.131E-06	6.718E-03	2.109E+00
3279	12.8	6.5	3.34	-3.131E-06	6.718E-03	2.109E+00
3280	0	0	0.54	-1.044E-06	2.239E-03	7.030E-01
3281	0	0	0	1.044E-06	-2.239E-03	-7.030E-01
3282	0	0	0	3.131E-06	-6.718E-03	-2.109E+00
3556	0	0	0	3.131E-06	-6.718E-03	-2.109E+00
3557	0.6	11.9	0	3.131E-06	-6.718E-03	-2.109E+00
3558	6.5	28.8	0.49	3.131E-06	-6.718E-03	-2.109E+00
3559	7.2	27	2	3.131E-06	-6.718E-03	-2.109E+00
3560	15.7	15	2.83	3.131E-06	-6.718E-03	-2.109E+00
3561	34.4	12.3	3.62	3.131E-06	-6.718E-03	-2.109E+00
3562	64.6	16.7	4.91	3.131E-06	-6.718E-03	-2.109E+00
3563	50.3	4.6	5.41	3.131E-06	-6.718E-03	-2.109E+00
3564	65.3	30.7	6.38	3.131E-06	-6.718E-03	-2.109E+00
3565	47.8	14.2	7.69	3.131E-06	-6.718E-03	-2.109E+00
3566	38.7	32.5	8.06	3.131E-06	-6.718E-03	-2.109E+00
3567	84.4	74.8	12.11	3.131E-06	-6.718E-03	-2.109E+00
3568	42.8	4.5	13.12	3.131E-06	-6.718E-03	-2.109E+00
3569	44	39.1	13.79	1.044E-06	-2.239E-03	-7.030E-01
3570	45.5	(°)	14.11	-1.044E-06	2.239E-03	7.030E-01
3571	39.2	(°)	13.18	-3.131E-06	6.718E-03	2.109E+00
3572	30.6	(°)	11.93	-3.131E-06	6.718E-03	2.109E+00
3573	13.5	0.7	9.43	-3.131E-06	6.718E-03	2.109E+00
3574	14.7	7.9	5.1	-3.131E-06	6.718E-03	2.109E+00
3575	1.2	(°)	2.51	-3.131E-06	6.718E-03	2.109E+00
3576	0.1	5.8	1.8	-1.044E-06	2.239E-03	7.030E-01
3577	4.1	10.8	1.74	1.044E-06	-2.239E-03	-7.030E-01
3578	6.8	10.2	2.16	3.131E-06	-6.718E-03	-2.109E+00
3579	5.3	4.6	2.17	3.131E-06	-6.718E-03	-2.109E+00
3580	0.9	5.4	2	3.131E-06	-6.718E-03	-2.109E+00
3581	0.3	10.6	2.03	3.131E-06	-6.718E-03	-2.109E+00
3582	6.1	12.3	2.12	3.131E-06	-6.718E-03	-2.109E+00
3583	14.3	15.2	2.77	3.131E-06	-6.718E-03	-2.109E+00
3584	27.3	8.3	3.33	3.131E-06	-6.718E-03	-2.109E+00
3585	33.1	3.6	3.59	3.131E-06	-6.718E-03	-2.109E+00
3586	31.1	2.5	3.51	3.131E-06	-6.718E-03	-2.109E+00
3587	33.3	5.1	3.59	3.131E-06	-6.718E-03	-2.109E+00
3588	40.7	5.2	3.91	3.131E-06	-6.718E-03	-2.109E+00
3589	43.5	2.3	4.04	3.131E-06	-6.718E-03	-2.109E+00
3590	38.6	1.8	3.83	3.131E-06	-6.718E-03	-2.109E+00
3591	44.8	6.7	4.09	3.131E-06	-6.718E-03	-2.109E+00
3592	57.6	8.2	4.63	3.131E-06	-6.718E-03	-2.109E+00
3593	49.5	10.2	4.96	3.131E-06	-6.718E-03	-2.109E+00
3594	44.3	16.7	5.26	3.131E-06	-6.718E-03	-2.109E+00
3595	73.3	20.3	6.86	3.131E-06	-6.718E-03	-2.109E+00
3596	46.1	13	7.63	3.131E-06	-6.718E-03	-2.109E+00
3597	38.4	32.8	8.03	3.131E-06	-6.718E-03	-2.109E+00
3598	75	46	11.34	3.131E-06	-6.718E-03	-2.109E+00

3599	48.3	13.8	12.5	3.131E-06	-6.718E-03	-2.109E+00
3600	36.9	36.6	12.76	3.131E-06	-6.718E-03	-2.109E+00
3601	59.4	72.6	15.98	3.131E-06	-6.718E-03	-2.109E+00
3602	82.2	57.1	19.37	3.131E-06	-6.718E-03	-2.109E+00
3603	59.9	2.7	20.07	3.131E-06	-6.718E-03	-2.109E+00
3604	60.4	43.6	20.65	1.044E-06	-2.239E-03	-7.030E-01
3605	59.8	( <sup>e</sup> )	20.68	-1.044E-06	2.239E-03	7.030E-01
3606	47.9	( <sup>e</sup> )	18.48	-3.131E-06	6.718E-03	2.109E+00
3607	35.5	( <sup>e</sup> )	16.12	-3.131E-06	6.718E-03	2.109E+00
3608	26.5	( <sup>e</sup> )	14.4	-3.131E-06	6.718E-03	2.109E+00
3609	21.3	( <sup>e</sup> )	13.41	-3.131E-06	6.718E-03	2.109E+00
3610	33	7.2	11.79	-3.131E-06	6.718E-03	2.109E+00
3611	11.3	( <sup>e</sup> )	9.06	-3.131E-06	6.718E-03	2.109E+00
3612	19.5	12.5	6.43	-3.131E-06	6.718E-03	2.109E+00
3613	13.9	( <sup>e</sup> )	4.34	-3.131E-06	6.718E-03	2.109E+00
3614	0	0	2.11	-1.044E-06	2.239E-03	7.030E-01
3615	0	0	0	1.044E-06	-2.239E-03	-7.030E-01
3616	0	0	0	3.131E-06	-6.718E-03	-2.109E+00
3631	0	0	0	3.131E-06	-6.718E-03	-2.109E+00
3632	1.1	7.1	0	3.131E-06	-6.718E-03	-2.109E+00
3633	4.3	13.6	0.11	3.131E-06	-6.718E-03	-2.109E+00
3634	6.3	22.9	1.02	3.131E-06	-6.718E-03	-2.109E+00
3635	6.6	17	1.96	3.131E-06	-6.718E-03	-2.109E+00
3636	6.4	9.9	2.33	3.131E-06	-6.718E-03	-2.109E+00
3637	7.9	9.9	2.5	3.131E-06	-6.718E-03	-2.109E+00
3638	15.2	14	2.81	3.131E-06	-6.718E-03	-2.109E+00
3639	31.5	9.6	3.51	3.131E-06	-6.718E-03	-2.109E+00
3640	46.2	8.1	4.14	3.131E-06	-6.718E-03	-2.109E+00
3641	68.3	14.2	5.08	3.131E-06	-6.718E-03	-2.109E+00
3642	44.3	1.2	5.14	3.131E-06	-6.718E-03	-2.109E+00
3643	75.6	38.8	6.93	3.131E-06	-6.718E-03	-2.109E+00
3644	46	8.5	8.06	3.131E-06	-6.718E-03	-2.109E+00
3645	45	33.7	8.63	3.131E-06	-6.718E-03	-2.109E+00
3646	89.9	66.8	12.65	3.131E-06	-6.718E-03	-2.109E+00
3647	40.7	0.4	13.06	3.131E-06	-6.718E-03	-2.109E+00
3648	46	48	14.06	3.131E-06	-6.718E-03	-2.109E+00
3649	72.2	82.4	17.83	3.131E-06	-6.718E-03	-2.109E+00
3650	75.6	17.4	20.25	3.131E-06	-6.718E-03	-2.109E+00
3651	58.3	36	20.27	3.131E-06	-6.718E-03	-2.109E+00
3652	71.6	75	22.69	3.131E-06	-6.718E-03	-2.109E+00
3653	83.1	25.7	24.95	3.131E-06	-6.718E-03	-2.109E+00
3654	51.8	20.3	24.78	3.131E-06	-6.718E-03	-2.109E+00
3655	59.3	70.8	26.5	3.131E-06	-6.718E-03	-2.109E+00
3656	70.7	80.1	29.27	3.131E-06	-6.718E-03	-2.109E+00
3657	76.9	26.6	30.86	3.131E-06	-6.718E-03	-2.109E+00
3658	49.2	2.5	30.59	3.131E-06	-6.718E-03	-2.109E+00
3659	49.7	15.4	31	1.044E-06	-2.239E-03	-7.030E-01
3660	49.1	( <sup>e</sup> )	30.84	-1.044E-06	2.239E-03	7.030E-01
3661	47.5	( <sup>e</sup> )	30.33	-3.131E-06	6.718E-03	2.109E+00
3662	46.3	( <sup>e</sup> )	29.98	-3.131E-06	6.718E-03	2.109E+00
3663	44	( <sup>e</sup> )	29.27	-3.131E-06	6.718E-03	2.109E+00
3664	39.4	( <sup>e</sup> )	27.91	-3.131E-06	6.718E-03	2.109E+00
3665	33.2	( <sup>e</sup> )	25.96	-3.131E-06	6.718E-03	2.109E+00
3666	28.7	( <sup>e</sup> )	24.56	-3.131E-06	6.718E-03	2.109E+00
3667	23.1	( <sup>e</sup> )	22.84	-3.131E-06	6.718E-03	2.109E+00
3668	33.7	13.1	20.96	-3.131E-06	6.718E-03	2.109E+00
3669	30.5	( <sup>e</sup> )	19.66	-3.131E-06	6.718E-03	2.109E+00
3670	24.9	( <sup>e</sup> )	18.32	-3.131E-06	6.718E-03	2.109E+00
3671	28.2	13.5	15.79	-3.131E-06	6.718E-03	2.109E+00
3672	22.4	4.6	12.51	-3.131E-06	6.718E-03	2.109E+00
3673	16.2	2.1	9.73	-3.131E-06	6.718E-03	2.109E+00
3674	16.5	5.1	7.5	-3.131E-06	6.718E-03	2.109E+00
3675	14	7.2	5.34	-3.131E-06	6.718E-03	2.109E+00
3676	13.5	5.4	3.39	-3.131E-06	6.718E-03	2.109E+00
3677	0	0	2.14	-3.131E-06	6.718E-03	2.109E+00
3678	0	0	0.73	-1.044E-06	2.239E-03	7.030E-01
3679	0	0	0	1.044E-06	-2.239E-03	-7.030E-01
3680	0	0	0	3.131E-06	-6.718E-03	-2.109E+00
3681	0	0	0	3.131E-06	-6.718E-03	-2.109E+00
3682	6	24.4	0.26	3.131E-06	-6.718E-03	-2.109E+00
3683	7.7	33.4	2.05	3.131E-06	-6.718E-03	-2.109E+00
3684	25.5	15.4	3.24	3.131E-06	-6.718E-03	-2.109E+00

3685	50.1	13	4.29	3.131E-06	-6.718E-03	-2.109E+00
3686	77	16.7	5.45	3.131E-06	-6.718E-03	-2.109E+00
3687	45.5	1.1	5.36	3.131E-06	-6.718E-03	-2.109E+00
3688	96	52.9	7.76	3.131E-06	-6.718E-03	-2.109E+00
3689	34.5	2.6	7.59	3.131E-06	-6.718E-03	-2.109E+00
3690	59.4	53.3	9.89	3.131E-06	-6.718E-03	-2.109E+00
3691	89.5	33.2	13.3	3.131E-06	-6.718E-03	-2.109E+00
3692	39.2	2	13.14	3.131E-06	-6.718E-03	-2.109E+00
3693	56.1	63.8	15.5	3.131E-06	-6.718E-03	-2.109E+00
3694	83.3	70	19.5	3.131E-06	-6.718E-03	-2.109E+00
3695	59.2	0.3	20.13	3.131E-06	-6.718E-03	-2.109E+00
3696	61.6	50.6	20.86	3.131E-06	-6.718E-03	-2.109E+00
3697	77.6	83.9	23.79	3.131E-06	-6.718E-03	-2.109E+00
3698	57.3	6	24.88	3.131E-06	-6.718E-03	-2.109E+00
3699	53.5	43.8	25.15	3.131E-06	-6.718E-03	-2.109E+00
3700	62.9	79.6	27.36	3.131E-06	-6.718E-03	-2.109E+00
3701	75	95.3	30.28	3.131E-06	-6.718E-03	-2.109E+00
3702	53.6	4.6	31.04	3.131E-06	-6.718E-03	-2.109E+00
3703	50.6	46.1	31.22	3.131E-06	-6.718E-03	-2.109E+00
3704	56.4	79.9	32.96	3.131E-06	-6.718E-03	-2.109E+00
3705	64	93.9	35.29	3.131E-06	-6.718E-03	-2.109E+00
3706	69.6	37.6	37.14	3.131E-06	-6.718E-03	-2.109E+00
3707	70.6	21.5	37.49	3.131E-06	-6.718E-03	-2.109E+00
3708	68	11.4	37.47	3.131E-06	-6.718E-03	-2.109E+00
3709	43	12.2	37.14	3.131E-06	-6.718E-03	-2.109E+00
3710	44.5	29.6	37.67	3.131E-06	-6.718E-03	-2.109E+00
3711	44.4	10.1	37.68	1.044E-06	-2.239E-03	-7.030E-01
3712	44	7	37.52	-1.044E-06	2.239E-03	7.030E-01
3713	43.1	2	37.2	-3.131E-06	6.718E-03	2.109E+00
3714	42.3	1.1	36.88	-3.131E-06	6.718E-03	2.109E+00
3715	41.2	( <sup>o</sup> )	36.45	-3.131E-06	6.718E-03	2.109E+00
3716	40	( <sup>o</sup> )	35.98	-3.131E-06	6.718E-03	2.109E+00
3717	38.7	( <sup>o</sup> )	35.45	-3.131E-06	6.718E-03	2.109E+00
3718	37.5	( <sup>o</sup> )	34.98	-3.131E-06	6.718E-03	2.109E+00
3719	36	( <sup>o</sup> )	34.35	-3.131E-06	6.718E-03	2.109E+00
3720	34.9	( <sup>o</sup> )	33.94	-3.131E-06	6.718E-03	2.109E+00
3721	32.8	( <sup>o</sup> )	33.13	-3.131E-06	6.718E-03	2.109E+00
3722	29.5	( <sup>o</sup> )	31.82	-3.131E-06	6.718E-03	2.109E+00
3723	25.9	( <sup>o</sup> )	30.38	-3.131E-06	6.718E-03	2.109E+00
3724	22.6	( <sup>o</sup> )	29.06	-3.131E-06	6.718E-03	2.109E+00
3725	19.9	( <sup>o</sup> )	27.94	-3.131E-06	6.718E-03	2.109E+00
3726	37	7.2	27.13	-3.131E-06	6.718E-03	2.109E+00
3727	32.7	( <sup>o</sup> )	25.82	-3.131E-06	6.718E-03	2.109E+00
3728	25.5	( <sup>o</sup> )	23.6	-3.131E-06	6.718E-03	2.109E+00
3729	19.6	4.9	21.48	-3.131E-06	6.718E-03	2.109E+00
3730	31.1	( <sup>o</sup> )	19.84	-3.131E-06	6.718E-03	2.109E+00
3731	25.9	( <sup>o</sup> )	18.54	-3.131E-06	6.718E-03	2.109E+00
3732	22.1	( <sup>o</sup> )	17.61	-3.131E-06	6.718E-03	2.109E+00
3733	36.9	12.8	16.17	-3.131E-06	6.718E-03	2.109E+00
3734	23.5	( <sup>o</sup> )	13.88	-3.131E-06	6.718E-03	2.109E+00
3735	30.2	6.8	11.44	-3.131E-06	6.718E-03	2.109E+00
3736	15.8	( <sup>o</sup> )	9.74	-3.131E-06	6.718E-03	2.109E+00
3737	22.3	3.5	8.06	-3.131E-06	6.718E-03	2.109E+00
3738	19.3	15.3	6.77	-3.131E-06	6.718E-03	2.109E+00
3739	15.8	9.3	5.41	-3.131E-06	6.718E-03	2.109E+00
3740	16.9	8.5	4.04	-3.131E-06	6.718E-03	2.109E+00
3741	0	0	2.53	-3.131E-06	6.718E-03	2.109E+00
3742	0	0	1.29	-1.044E-06	2.239E-03	7.030E-01
3743	0	0	0	1.044E-06	-2.239E-03	-7.030E-01
3744	1.7	9.1	0.06	3.131E-06	-6.718E-03	-2.109E+00
3745	7.1	31.5	1.17	3.131E-06	-6.718E-03	-2.109E+00
3746	10.3	21.5	2.59	3.131E-06	-6.718E-03	-2.109E+00
3747	43	17.4	3.98	3.131E-06	-6.718E-03	-2.109E+00
3748	89.3	31.2	5.76	3.131E-06	-6.718E-03	-2.109E+00
3749	52.3	1.8	5.74	3.131E-06	-6.718E-03	-2.109E+00
3750	101.6	65.3	8.02	3.131E-06	-6.718E-03	-2.109E+00
3751	38	1.8	7.95	3.131E-06	-6.718E-03	-2.109E+00
3752	65.1	55.2	10.4	3.131E-06	-6.718E-03	-2.109E+00
3753	78.5	29.8	13.35	3.131E-06	-6.718E-03	-2.109E+00
3754	40.6	15.2	13.34	3.131E-06	-6.718E-03	-2.109E+00
3755	60.4	67.5	16.13	3.131E-06	-6.718E-03	-2.109E+00
3756	90	70.2	20.44	3.131E-06	-6.718E-03	-2.109E+00

3757	60.3	2.3	20.41	3.131E-06	-6.718E-03	-2.109E+00
3758	66.9	60.6	21.82	3.131E-06	-6.718E-03	-2.109E+00
3759	79.2	30	24.21	3.131E-06	-6.718E-03	-2.109E+00
3760	51.3	1.2	24.25	3.131E-06	-6.718E-03	-2.109E+00
3761	53.4	47.7	25.13	3.131E-06	-6.718E-03	-2.109E+00
3762	55.7	8.4	25.76	3.131E-06	-6.718E-03	-2.109E+00
3763	55.4	(°)	25.7	3.131E-06	-6.718E-03	-2.109E+00
3764	54.3	1.4	25.43	3.131E-06	-6.718E-03	-2.109E+00
3765	53.9	4.1	25.33	3.131E-06	-6.718E-03	-2.109E+00
3766	54.1	9.3	25.38	3.131E-06	-6.718E-03	-2.109E+00
3767	55.6	18.5	25.7	3.131E-06	-6.718E-03	-2.109E+00
3768	59.3	36.6	26.57	3.131E-06	-6.718E-03	-2.109E+00
3769	63.8	30.1	27.69	3.131E-06	-6.718E-03	-2.109E+00
3770	66.4	18.2	28.36	3.131E-06	-6.718E-03	-2.109E+00
3771	43.1	0.4	28.38	3.131E-06	-6.718E-03	-2.109E+00
3772	43	51.1	28.85	3.131E-06	-6.718E-03	-2.109E+00
3773	49.6	81	30.82	3.131E-06	-6.718E-03	-2.109E+00
3774	55.1	49	32.61	-4.060E-06	-1.596E-03	-2.202E+00
3775	58.9	44.6	33.79	-1.125E-05	3.526E-03	-2.294E+00
3776	62.5	46.7	34.91	-1.844E-05	8.648E-03	-2.387E+00
3777	64.9	25.7	35.71	-1.844E-05	8.648E-03	-2.387E+00
3778	65.7	13.7	35.98	-1.844E-05	8.648E-03	-2.387E+00
3779	41.7	0.4	35.85	-1.844E-05	8.648E-03	-2.387E+00
3780	40.5	31.8	36.07	-1.844E-05	8.648E-03	-2.387E+00
3781	41.2	21	36.4	-1.844E-05	8.648E-03	-2.387E+00
3782	41.2	7.1	36.43	-1.844E-05	8.648E-03	-2.387E+00
3783	41.2	11.4	36.39	-1.844E-05	8.648E-03	-2.387E+00
3784	41.6	20.9	36.54	-1.844E-05	8.648E-03	-2.387E+00
3785	42.2	21.1	36.79	-1.844E-05	8.648E-03	-2.387E+00
3786	42.8	19.8	37.01	-1.844E-05	8.648E-03	-2.387E+00
3787	43.8	30.5	37.39	-1.844E-05	8.648E-03	-2.387E+00
3788	44.4	17.7	37.66	-1.844E-05	8.648E-03	-2.387E+00
3789	45.2	27.6	37.98	-1.844E-05	8.648E-03	-2.387E+00
3790	45.7	16.6	38.18	-1.844E-05	8.648E-03	-2.387E+00
3791	46.7	31.9	38.56	-1.844E-05	8.648E-03	-2.387E+00
3792	47.7	27.1	38.96	-1.844E-05	8.648E-03	-2.387E+00
3793	49.1	37.5	39.52	-1.844E-05	8.648E-03	-2.387E+00
3794	50.8	40.8	40.19	-1.844E-05	8.648E-03	-2.387E+00
3795	52.7	45.9	40.94	-1.844E-05	8.648E-03	-2.387E+00
3796	54.7	44.6	41.74	-1.844E-05	8.648E-03	-2.387E+00
3797	56.7	46.3	42.52	-1.844E-05	8.648E-03	-2.387E+00
3798	58.9	52.6	43.37	-1.844E-05	8.648E-03	-2.387E+00
3799	60.1	16.2	43.94	-1.844E-05	8.648E-03	-2.387E+00
3800	58	(°)	43.21	-1.844E-05	8.648E-03	-2.387E+00
3801	34.9	(°)	42.38	-1.844E-05	8.648E-03	-2.387E+00
3802	32.8	3.8	41.99	-1.844E-05	8.648E-03	-2.387E+00
3803	32.2	(°)	41.68	-1.844E-05	8.648E-03	-2.387E+00
3804	31.2	(°)	41.2	-1.844E-05	8.648E-03	-2.387E+00
3805	29.8	(°)	40.52	-1.844E-05	8.648E-03	-2.387E+00
3806	28.7	(°)	39.92	-1.844E-05	8.648E-03	-2.387E+00
3807	27.3	(°)	39.25	-1.844E-05	8.648E-03	-2.387E+00
3808	25.7	(°)	38.45	-1.844E-05	8.648E-03	-2.387E+00
3809	24.9	(°)	37.98	-1.844E-05	8.648E-03	-2.387E+00
3810	23.7	(°)	37.42	-1.844E-05	8.648E-03	-2.387E+00
3811	22.7	(°)	36.9	-1.844E-05	8.648E-03	-2.387E+00
3812	21.9	(°)	36.47	-1.844E-05	8.648E-03	-2.387E+00
3813	20.7	(°)	35.88	-1.844E-05	8.648E-03	-2.387E+00
3814	19.4	(°)	35.48	-1.844E-05	8.648E-03	-2.387E+00
3815	38.2	1.1	35.24	-1.844E-05	8.648E-03	-2.387E+00
3816	38.1	22.8	35.17	-1.844E-05	8.648E-03	-2.387E+00
3817	39.7	39.3	35.76	-1.844E-05	8.648E-03	-2.387E+00
3818	41.4	29.7	36.43	-1.844E-05	8.648E-03	-2.387E+00
3819	41.8	14.7	36.65	-1.342E-05	6.645E-03	-2.027E+00
3820	41.9	12.7	36.69	-8.405E-06	4.643E-03	-1.667E+00
3821	42.2	21.3	36.77	-3.386E-06	2.640E-03	-1.307E+00
3822	43.4	31.2	37.26	-3.386E-06	2.640E-03	-1.307E+00
3823	44.2	21	37.59	-3.386E-06	2.640E-03	-1.307E+00
3824	44.7	18.6	37.78	-3.386E-06	2.640E-03	-1.307E+00
3825	45.1	17.6	37.96	-3.386E-06	2.640E-03	-1.307E+00
3826	45.4	16.8	38.05	-3.386E-06	2.640E-03	-1.307E+00
3827	45.9	18.5	38.25	-3.386E-06	2.640E-03	-1.307E+00
3828	46	13	38.32	-3.386E-06	2.640E-03	-1.307E+00



3829	46	14.4	38.33	-3.386E-06	2.640E-03	-1.307E+00
3830	46.4	10.9	38.46	-3.386E-06	2.640E-03	-1.307E+00
3831	45.5	(°)	38.15	-3.386E-06	2.640E-03	-1.307E+00
3832	44.4	(°)	37.72	-3.386E-06	2.640E-03	-1.307E+00
3833	42.8	(°)	37.08	-3.386E-06	2.640E-03	-1.307E+00
3834	41.1	(°)	36.43	-3.386E-06	2.640E-03	-1.307E+00
3835	39.2	(°)	35.66	-3.386E-06	2.640E-03	-1.307E+00
3836	38.1	(°)	35.2	-3.386E-06	2.640E-03	-1.307E+00
3837	37.9	10.9	35.1	-3.386E-06	2.640E-03	-1.307E+00
3838	37.9	12.9	35.1	-3.386E-06	2.640E-03	-1.307E+00
3839	38.3	17.9	35.22	-3.386E-06	2.640E-03	-1.307E+00
3840	38.7	8.5	35.4	-3.386E-06	2.640E-03	-1.307E+00
3841	37.6	(°)	35.02	-3.386E-06	2.640E-03	-1.307E+00
3842	37.6	14.5	34.95	-3.386E-06	2.640E-03	-1.307E+00
3843	37.5	8.5	34.93	-3.386E-06	2.640E-03	-1.307E+00
3844	37.4	7.6	34.88	-3.386E-06	2.640E-03	-1.307E+00
3845	36.9	5.2	34.72	-3.386E-06	2.640E-03	-1.307E+00
3846	36.9	13.2	34.69	-3.386E-06	2.640E-03	-1.307E+00
3847	37.2	13.9	34.8	-3.386E-06	2.640E-03	-1.307E+00
3848	37	6.9	34.75	-3.386E-06	2.640E-03	-1.307E+00
3849	36.8	2.4	34.65	-3.386E-06	2.640E-03	-1.307E+00
3850	35.8	(°)	34.27	-3.386E-06	2.640E-03	-1.307E+00
3851	35.2	3.1	34.02	-3.386E-06	2.640E-03	-1.307E+00
3852	34.6	2.3	33.78	-3.386E-06	2.640E-03	-1.307E+00
3853	34.4	10.4	33.7	-3.386E-06	2.640E-03	-1.307E+00
3854	34.5	10.5	33.71	-3.386E-06	2.640E-03	-1.307E+00
3855	34.3	6.5	33.64	-3.386E-06	2.640E-03	-1.307E+00
3856	34	4.6	33.52	-3.386E-06	2.640E-03	-1.307E+00
3857	33.5	6	33.34	-3.386E-06	2.640E-03	-1.307E+00
3858	33.8	20.3	33.42	-3.386E-06	2.640E-03	-1.307E+00
3859	34.7	28.4	33.77	-3.386E-06	2.640E-03	-1.307E+00
3860	35.8	31.3	34.24	-3.386E-06	2.640E-03	-1.307E+00
3861	37.2	29.8	34.76	-3.386E-06	2.640E-03	-1.307E+00
3862	37.8	18.2	35.05	-3.386E-06	2.640E-03	-1.307E+00
3863	38.1	14.9	35.16	-3.386E-06	2.640E-03	-1.307E+00
3864	38.4	11.4	35.28	-3.386E-06	2.640E-03	-1.307E+00
3865	37.6	(°)	35.01	-3.386E-06	2.640E-03	-1.307E+00
3866	37.1	1.7	34.79	-3.386E-06	2.640E-03	-1.307E+00
3867	36.2	(°)	34.42	-3.386E-06	2.640E-03	-1.307E+00
3868	35.2	(°)	34.03	-3.386E-06	2.640E-03	-1.307E+00
3869	34.4	(°)	33.69	-3.386E-06	2.640E-03	-1.307E+00
3870	34.1	10.8	33.59	-3.386E-06	2.640E-03	-1.307E+00
3871	34.3	14.3	33.65	-3.386E-06	2.640E-03	-1.307E+00
3872	34.5	13.3	33.72	-3.386E-06	2.640E-03	-1.307E+00
3873	34.6	12.7	33.78	-3.386E-06	2.640E-03	-1.307E+00
3874	34.7	12.1	33.8	-3.386E-06	2.640E-03	-1.307E+00
3875	34.9	19.8	33.88	-3.386E-06	2.640E-03	-1.307E+00
3876	36.2	30.9	34.36	-3.386E-06	2.640E-03	-1.307E+00
3877	36.6	15.7	34.57	-3.386E-06	2.640E-03	-1.307E+00
3878	37.1	13.5	34.77	-1.129E-06	8.799E-04	-4.358E-01
3879	36.2	(°)	34.44	1.129E-06	-8.799E-04	4.358E-01
3880	33.1	(°)	33.26	3.386E-06	-2.640E-03	1.307E+00
3881	29	(°)	31.65	3.386E-06	-2.640E-03	1.307E+00
3882	24.8	(°)	29.96	3.386E-06	-2.640E-03	1.307E+00
3883	21.1	(°)	28.47	3.386E-06	-2.640E-03	1.307E+00
3884	38.5	15.7	27.48	3.386E-06	-2.640E-03	1.307E+00
3885	35.8	(°)	26.73	3.386E-06	-2.640E-03	1.307E+00
3886	33.7	(°)	26.07	3.386E-06	-2.640E-03	1.307E+00
3887	30.7	(°)	25.15	3.386E-06	-2.640E-03	1.307E+00
3888	27.3	(°)	24.1	3.386E-06	-2.640E-03	1.307E+00
3889	26.6	13.3	23.83	3.386E-06	-2.640E-03	1.307E+00
3890	27.9	30.6	24.19	3.386E-06	-2.640E-03	1.307E+00
3891	30.7	41.6	25.07	3.386E-06	-2.640E-03	1.307E+00
3892	32.5	15.8	25.65	3.386E-06	-2.640E-03	1.307E+00
3893	31.9	(°)	25.51	3.386E-06	-2.640E-03	1.307E+00
3894	21.8	(°)	22.52	3.386E-06	-2.640E-03	1.307E+00
3895	25.6	4.2	17.98	3.386E-06	-2.640E-03	1.307E+00
3896	26.8	3.8	14.07	3.386E-06	-2.640E-03	1.307E+00
3897	20.2	2.5	10.09	3.386E-06	-2.640E-03	1.307E+00
3898	14.3	2.8	5.72	3.386E-06	-2.640E-03	1.307E+00
3899	11.3	6.7	3.24	3.386E-06	-2.640E-03	1.307E+00
3900	0	0	0.61	3.386E-06	-2.640E-03	1.307E+00

3901	0	0	0	3.386E-06	-2.640E-03	1.307E+00
3906	0	0	0	3.386E-06	-2.640E-03	1.307E+00
3907	0	0	0	6.559E-06	-6.283E-03	3.321E+00
3908	0	0	0	9.732E-06	-9.925E-03	5.334E+00
3909	0	0	0	1.291E-05	-1.357E-02	7.347E+00
3918	0	0	0	1.291E-05	-1.357E-02	7.347E+00
3919	3	5	0	1.291E-05	-1.357E-02	7.347E+00
3920	7	10	0	1.291E-05	-1.357E-02	7.347E+00
3921	6.7	32.8	0.66	1.291E-05	-1.357E-02	7.347E+00
3922	6.3	35	1.59	1.291E-05	-1.357E-02	7.347E+00
3923	5.8	25.2	2.33	1.291E-05	-1.357E-02	7.347E+00
3924	6.1	10.4	2.69	1.291E-05	-1.357E-02	7.347E+00
3925	0	0	2.52	1.291E-05	-1.357E-02	7.347E+00
3926	0.1	5.8	1.77	1.291E-05	-1.357E-02	7.347E+00
3927	0	0	0.66	1.291E-05	-1.357E-02	7.347E+00
3928	0	0	0	1.291E-05	-1.357E-02	7.347E+00
3929	0	0	0	1.291E-05	-1.357E-02	7.347E+00
3930	1.3	9.6	0	1.291E-05	-1.357E-02	7.347E+00
3931	6.3	36.6	0.32	1.291E-05	-1.357E-02	7.347E+00
3932	6.5	48.5	1.27	1.291E-05	-1.357E-02	7.347E+00
3933	5.9	38.4	2.24	1.291E-05	-1.357E-02	7.347E+00
3934	9.7	20.5	2.84	1.291E-05	-1.357E-02	7.347E+00
3935	17.5	14.9	3.17	1.291E-05	-1.357E-02	7.347E+00
3936	22.2	9	3.37	1.291E-05	-1.357E-02	7.347E+00
3937	22.6	4.6	3.39	1.291E-05	-1.357E-02	7.347E+00
3938	17.2	3.2	3.16	1.291E-05	-1.357E-02	7.347E+00
3939	10.7	(*)	2.89	1.291E-05	-1.357E-02	7.347E+00
3940	0	0	2.72	1.291E-05	-1.357E-02	7.347E+00
3941	0	0	2.11	1.291E-05	-1.357E-02	7.347E+00
3942	0	0	1.33	1.291E-05	-1.357E-02	7.347E+00
3943	0	0	0.85	1.291E-05	-1.357E-02	7.347E+00
3944	0	0	0.42	1.291E-05	-1.357E-02	7.347E+00
3945	0	0	0	1.291E-05	-1.357E-02	7.347E+00
4069	0	0	0	1.291E-05	-1.357E-02	7.347E+00
4070	1.2	9.5	0	1.291E-05	-1.357E-02	7.347E+00
4071	5.2	20.5	0.02	1.291E-05	-1.357E-02	7.347E+00
4072	5	20.8	0.43	1.291E-05	-1.357E-02	7.347E+00
4073	5.4	23.1	0.8	1.291E-05	-1.357E-02	7.347E+00
4074	5.1	18.1	1.22	1.291E-05	-1.357E-02	7.347E+00
4075	4.3	8.7	1.37	1.291E-05	-1.357E-02	7.347E+00
4076	0	0	1.34	1.291E-05	-1.357E-02	7.347E+00
4077	0	0	1.03	1.291E-05	-1.357E-02	7.347E+00
4078	0.8	6.4	0.65	1.291E-05	-1.357E-02	7.347E+00
4079	5.3	18.7	0.3	1.291E-05	-1.357E-02	7.347E+00
4080	4.8	19.6	0.26	1.291E-05	-1.357E-02	7.347E+00
4081	5.5	29.5	0.31	1.291E-05	-1.357E-02	7.347E+00
4082	6	38.2	0.92	1.291E-05	-1.357E-02	7.347E+00
4083	4.3	14.8	1.84	1.291E-05	-1.357E-02	7.347E+00
4084	4.3	8.7	1.92	1.291E-05	-1.357E-02	7.347E+00
4085	0.1	7.5	2.03	1.291E-05	-1.357E-02	7.347E+00
4086	0.1	5.9	2.46	1.291E-05	-1.357E-02	7.347E+00
4087	0.7	5.8	2.47	1.291E-05	-1.357E-02	7.347E+00
4088	0	0	2.68	1.291E-05	-1.357E-02	7.347E+00
4089	0	0	2.3	1.291E-05	-1.357E-02	7.347E+00
4090	0	0	1.2	1.291E-05	-1.357E-02	7.347E+00
4091	0	0	0.41	1.291E-05	-1.357E-02	7.347E+00
4092	0	0	0	1.291E-05	-1.357E-02	7.347E+00
4099	0	0	0	1.291E-05	-1.357E-02	7.347E+00
4100	0	0	0	1.174E-05	-1.229E-02	6.551E+00
4101	0	0	0	1.057E-05	-1.102E-02	5.754E+00
4102	0	0	0	9.395E-06	-9.748E-03	4.957E+00
4107	0	0	0	9.395E-06	-9.748E-03	4.957E+00
4108	0.9	5.4	0	9.395E-06	-9.748E-03	4.957E+00
4109	0.5	5.7	0	9.395E-06	-9.748E-03	4.957E+00
4110	0	0	0	9.395E-06	-9.748E-03	4.957E+00
4113	0	0	0	9.395E-06	-9.748E-03	4.957E+00
4114	0.3	10	0	9.395E-06	-9.748E-03	4.957E+00
4115	1.1	9.9	0	9.395E-06	-9.748E-03	4.957E+00
4116	1.6	9.7	0	9.395E-06	-9.748E-03	4.957E+00
4117	2.8	9.3	0	9.395E-06	-9.748E-03	4.957E+00
4118	2.3	9	0	9.395E-06	-9.748E-03	4.957E+00
4119	0.8	9.8	0	9.395E-06	-9.748E-03	4.957E+00

4120	1.4	9.6	0	9.395E-06	-9.748E-03	4.957E+00
4121	4.6	14	0.05	9.395E-06	-9.748E-03	4.957E+00
4122	4.5	13.1	0.2	9.395E-06	-9.748E-03	4.957E+00
4123	4.8	16	0.38	9.395E-06	-9.748E-03	4.957E+00
4124	5.1	18.8	0.54	9.395E-06	-9.748E-03	4.957E+00
4125	6	31.2	0.73	9.395E-06	-9.748E-03	4.957E+00
4126	7.1	52.5	1.23	9.395E-06	-9.748E-03	4.957E+00
4127	6	46	2.1	9.395E-06	-9.748E-03	4.957E+00
4128	9.5	25.5	2.83	9.395E-06	-9.748E-03	4.957E+00
4129	21.1	18.5	3.31	9.395E-06	-9.748E-03	4.957E+00
4130	32.1	12.2	3.78	9.395E-06	-9.748E-03	4.957E+00
4131	42	7.6	4.19	9.395E-06	-9.748E-03	4.957E+00
4132	48	9.1	4.44	9.395E-06	-9.748E-03	4.957E+00
4133	55.9	9.4	4.77	9.395E-06	-9.748E-03	4.957E+00
4134	33.8	14.3	4.64	9.395E-06	-9.748E-03	4.957E+00
4135	21.5	25	4.56	9.395E-06	-9.748E-03	4.957E+00
4136	24.7	9.1	4.75	9.395E-06	-9.748E-03	4.957E+00
4137	25.5	4.5	4.8	9.395E-06	-9.748E-03	4.957E+00
4138	28.7	9.9	4.98	9.395E-06	-9.748E-03	4.957E+00
4139	34.4	10.7	5.31	9.395E-06	-9.748E-03	4.957E+00
4140	40.5	4.7	5.65	9.395E-06	-9.748E-03	4.957E+00
4141	42.8	3.3	5.79	9.395E-06	-9.748E-03	4.957E+00
4142	43.4	0	5.82	9.395E-06	-9.748E-03	4.957E+00
4143	39.5	(°)	5.61	9.395E-06	-9.748E-03	4.957E+00
4144	34.1	(°)	5.3	9.395E-06	-9.748E-03	4.957E+00
4145	22	(°)	4.62	9.395E-06	-9.748E-03	4.957E+00
4146	0	0	2.84	9.395E-06	-9.748E-03	4.957E+00
4147	0	0	1.03	9.395E-06	-9.748E-03	4.957E+00
4148	0	0	0.44	9.395E-06	-9.748E-03	4.957E+00
4149	1.1	10.1	0.44	9.395E-06	-9.748E-03	4.957E+00
4150	7.2	38.5	1.04	9.395E-06	-9.748E-03	4.957E+00
4151	6.5	34.3	2.07	9.395E-06	-9.748E-03	4.957E+00
4152	6.2	18	2.69	9.395E-06	-9.748E-03	4.957E+00
4153	13.3	18.5	2.99	9.395E-06	-9.748E-03	4.957E+00
4154	21.3	13.1	3.32	9.395E-06	-9.748E-03	4.957E+00
4155	25.8	8.2	3.52	9.395E-06	-9.748E-03	4.957E+00
4156	27.2	6.2	3.57	9.395E-06	-9.748E-03	4.957E+00
4157	29.8	3	3.69	9.395E-06	-9.748E-03	4.957E+00
4158	29.7	3.6	3.68	9.395E-06	-9.748E-03	4.957E+00
4159	31.4	4.4	3.75	9.395E-06	-9.748E-03	4.957E+00
4160	31	5.6	3.73	9.395E-06	-9.748E-03	4.957E+00
4161	29.2	4.6	3.66	9.395E-06	-9.748E-03	4.957E+00
4162	27	5.2	3.57	9.395E-06	-9.748E-03	4.957E+00
4163	24	7.4	3.44	9.395E-06	-9.748E-03	4.957E+00
4164	22.2	8.8	3.37	9.395E-06	-9.748E-03	4.957E+00
4165	21.8	9	3.35	9.395E-06	-9.748E-03	4.957E+00
4166	23.2	8.6	3.41	9.395E-06	-9.748E-03	4.957E+00
4167	23.3	8.9	3.41	9.395E-06	-9.748E-03	4.957E+00
4168	21.2	6.4	3.33	9.395E-06	-9.748E-03	4.957E+00
4169	18.2	3.9	3.2	9.395E-06	-9.748E-03	4.957E+00
4170	13.7	7.6	3.01	9.395E-06	-9.748E-03	4.957E+00
4171	10.5	10.9	2.88	9.395E-06	-9.748E-03	4.957E+00
4172	9.9	7.9	2.85	9.395E-06	-9.748E-03	4.957E+00
4173	5.2	0.5	2.66	9.395E-06	-9.748E-03	4.957E+00
4174	0	0	2.19	9.395E-06	-9.748E-03	4.957E+00
4175	0	0	1.22	9.395E-06	-9.748E-03	4.957E+00
4176	0	0	0.53	9.395E-06	-9.748E-03	4.957E+00
4177	2.7	10	0.26	9.395E-06	-9.748E-03	4.957E+00
4178	5.1	19.6	0.04	9.395E-06	-9.748E-03	4.957E+00
4179	6.8	47.4	0.82	9.395E-06	-9.748E-03	4.957E+00
4180	6.2	45.8	1.96	9.395E-06	-9.748E-03	4.957E+00
4181	5.9	29.5	2.65	9.395E-06	-9.748E-03	4.957E+00
4182	10.2	15.6	2.86	9.395E-06	-9.748E-03	4.957E+00
4183	12.9	13.2	2.98	9.395E-06	-9.748E-03	4.957E+00
4184	13.8	17.7	3.01	9.395E-06	-9.748E-03	4.957E+00
4185	18.1	7.9	3.2	9.395E-06	-9.748E-03	4.957E+00
4186	17.3	3.6	3.16	9.395E-06	-9.748E-03	4.957E+00
4187	13.9	2.4	3.02	9.395E-06	-9.748E-03	4.957E+00
4188	12.6	0.6	2.97	9.395E-06	-9.748E-03	4.957E+00
4189	10.6	(°)	2.89	9.395E-06	-9.748E-03	4.957E+00
4190	8.1	4.3	2.77	9.395E-06	-9.748E-03	4.957E+00
4191	0	0	2.48	9.395E-06	-9.748E-03	4.957E+00

4192	0	0	1.81	9.395E-06	-9.748E-03	4.957E+00
4193	0	0	1.27	9.395E-06	-9.748E-03	4.957E+00
4194	0.8	8.7	1.01	9.395E-06	-9.748E-03	4.957E+00
4195	6.5	25	0.93	9.395E-06	-9.748E-03	4.957E+00
4196	6.3	28.5	1.41	9.395E-06	-9.748E-03	4.957E+00
4197	5.7	19.5	2	9.395E-06	-9.748E-03	4.957E+00
4198	5.4	10.8	2.3	9.395E-06	-9.748E-03	4.957E+00
4199	5.7	10.2	2.32	9.395E-06	-9.748E-03	4.957E+00
4200	6.6	16.4	2.4	9.395E-06	-9.748E-03	4.957E+00
4201	6.9	13.9	2.69	9.395E-06	-9.748E-03	4.957E+00
4202	0	0	2.58	9.395E-06	-9.748E-03	4.957E+00
4203	0	0	2.18	9.395E-06	-9.748E-03	4.957E+00
4204	0	0	1.79	9.395E-06	-9.748E-03	4.957E+00
4205	0	0	1.59	9.395E-06	-9.748E-03	4.957E+00
4206	0.2	5.8	1.44	9.395E-06	-9.748E-03	4.957E+00
4207	0.4	5.8	1.29	9.395E-06	-9.748E-03	4.957E+00
4208	0.7	10	1.24	9.395E-06	-9.748E-03	4.957E+00
4209	0.5	9.9	1.21	9.395E-06	-9.748E-03	4.957E+00
4210	0.1	5.9	1.01	9.395E-06	-9.748E-03	4.957E+00
4211	0	0	0.45	9.395E-06	-9.748E-03	4.957E+00
4212	0.6	8.4	0.07	9.395E-06	-9.748E-03	4.957E+00
4213	4.5	13.9	0	9.395E-06	-9.748E-03	4.957E+00
4214	4.9	19.7	0.06	9.395E-06	-9.748E-03	4.957E+00
4215	4.9	23.1	0.24	9.395E-06	-9.748E-03	4.957E+00
4216	4.7	22	0.44	9.395E-06	-9.748E-03	4.957E+00
4217	4.7	20.2	0.64	9.395E-06	-9.748E-03	4.957E+00
4218	4.4	15.3	0.78	9.395E-06	-9.748E-03	4.957E+00
4219	0	0	0.74	9.395E-06	-9.748E-03	4.957E+00
4220	1.3	9.9	0.72	9.395E-06	-9.748E-03	4.957E+00
4221	5.6	16.9	0.81	9.395E-06	-9.748E-03	4.957E+00
4222	5.3	14.9	1.05	9.395E-06	-9.748E-03	4.957E+00
4223	0.3	8.4	1.06	9.395E-06	-9.748E-03	4.957E+00
4224	0	0	1.04	9.395E-06	-9.748E-03	4.957E+00
4225	0.3	6.2	0.99	9.395E-06	-9.748E-03	4.957E+00
4226	0.1	5.8	0.88	9.395E-06	-9.748E-03	4.957E+00
4227	0	0	1.12	9.395E-06	-9.748E-03	4.957E+00
4228	0	0	1.03	9.395E-06	-9.748E-03	4.957E+00
4229	0	0	0.55	9.395E-06	-9.748E-03	4.957E+00
4230	0.6	8.3	0.01	9.395E-06	-9.748E-03	4.957E+00
4231	0	0	0	9.395E-06	-9.748E-03	4.957E+00
4249	0	0	0	9.395E-06	-9.748E-03	4.957E+00
4250	0	0	0	9.571E-06	-9.949E-03	4.821E+00
4251	0	0	0	9.747E-06	-1.015E-02	4.685E+00
4252	0	0	0	9.923E-06	-1.035E-02	4.549E+00
4871	0	0	0	9.923E-06	-1.035E-02	4.549E+00
4872	0.9	7.3	0	9.923E-06	-1.035E-02	4.549E+00
4873	0	0	0	9.923E-06	-1.035E-02	4.549E+00
4874	0	0	0	9.923E-06	-1.035E-02	4.549E+00
4875	1.1	6.6	0	9.923E-06	-1.035E-02	4.549E+00
4876	5.1	19.6	0	9.923E-06	-1.035E-02	4.549E+00
4877	6.3	42.9	0.4	9.923E-06	-1.035E-02	4.549E+00
4878	5.6	42.1	1.15	9.923E-06	-1.035E-02	4.549E+00
4879	5.1	28.9	1.82	9.923E-06	-1.035E-02	4.549E+00
4880	5.8	26.2	2.12	9.923E-06	-1.035E-02	4.549E+00
4881	6.1	23.6	2.56	9.923E-06	-1.035E-02	4.549E+00
4882	9.3	12.8	2.83	9.923E-06	-1.035E-02	4.549E+00
4883	12.1	12.2	2.94	9.923E-06	-1.035E-02	4.549E+00
4884	16.8	15.6	3.14	9.923E-06	-1.035E-02	4.549E+00
4885	26	16.1	3.52	9.923E-06	-1.035E-02	4.549E+00
4886	39.2	15.2	4.07	9.923E-06	-1.035E-02	4.549E+00
4887	55.7	15.4	4.76	9.923E-06	-1.035E-02	4.549E+00
4888	43.9	13.3	5.16	9.923E-06	-1.035E-02	4.549E+00
4889	36.9	23.2	5.44	9.923E-06	-1.035E-02	4.549E+00
4890	48	11.8	6.08	9.923E-06	-1.035E-02	4.549E+00
4891	55.2	13.7	6.49	9.923E-06	-1.035E-02	4.549E+00
4892	64.8	10.6	7.04	9.923E-06	-1.035E-02	4.549E+00
4893	33.1	0.7	7.06	9.923E-06	-1.035E-02	4.549E+00
4894	34.1	6.1	7.3	9.923E-06	-1.035E-02	4.549E+00
4895	32.1	(°)	7.15	9.923E-06	-1.035E-02	4.549E+00
4896	27.4	(°)	6.79	9.923E-06	-1.035E-02	4.549E+00
4897	18.5	(°)	6.08	9.923E-06	-1.035E-02	4.549E+00
4898	6.8	0.8	5.2	9.923E-06	-1.035E-02	4.549E+00

4899	0	0	4	9.923E-06	-1.035E-02	4.549E+00
4900	0	0	2.69	9.923E-06	-1.035E-02	4.549E+00
4901	0	0	1.3	9.923E-06	-1.035E-02	4.549E+00
4902	0	0	0.37	9.923E-06	-1.035E-02	4.549E+00
4903	0	0	0	9.923E-06	-1.035E-02	4.549E+00
4919	0	0	0	9.923E-06	-1.035E-02	4.549E+00
4920	0	0	0	9.399E-06	-9.777E-03	4.270E+00
4921	0	0	0	8.875E-06	-9.204E-03	3.992E+00
4922	0	0	0	8.351E-06	-8.632E-03	3.713E+00
5120	0	0	0	8.351E-06	-8.632E-03	3.713E+00
5121	1	7.5	0	8.351E-06	-8.632E-03	3.713E+00
5122	0	0	0	8.351E-06	-8.632E-03	3.713E+00
5123	0	0	0	8.351E-06	-8.632E-03	3.713E+00
5124	1.2	6.9	0	8.351E-06	-8.632E-03	3.713E+00
5125	5.9	28.2	0.07	8.351E-06	-8.632E-03	3.713E+00
5126	6	37.9	0.65	8.351E-06	-8.632E-03	3.713E+00
5127	5.7	36.4	1.29	8.351E-06	-8.632E-03	3.713E+00
5128	6.4	40.8	1.88	8.351E-06	-8.632E-03	3.713E+00
5129	7	44.4	2.48	8.351E-06	-8.632E-03	3.713E+00
5130	17.5	30.8	3.16	8.351E-06	-8.632E-03	3.713E+00
5131	33	16.5	3.81	8.351E-06	-8.632E-03	3.713E+00
5132	43.5	15.8	4.25	8.351E-06	-8.632E-03	3.713E+00
5133	54.5	11.2	4.71	8.351E-06	-8.632E-03	3.713E+00
5134	45.5	16.1	4.87	8.351E-06	-8.632E-03	3.713E+00
5135	23.1	31.7	4.65	8.351E-06	-8.632E-03	3.713E+00
5136	32.4	17.3	5.19	8.351E-06	-8.632E-03	3.713E+00
5137	40.6	6.3	5.66	8.351E-06	-8.632E-03	3.713E+00
5138	47.3	(°)	6.05	8.351E-06	-8.632E-03	3.713E+00
5139	50.3	(°)	6.22	8.351E-06	-8.632E-03	3.713E+00
5140	51	(°)	6.26	8.351E-06	-8.632E-03	3.713E+00
5141	48.1	(°)	6.1	8.351E-06	-8.632E-03	3.713E+00
5142	44.8	(°)	5.91	8.351E-06	-8.632E-03	3.713E+00
5143	40.4	(°)	5.66	8.351E-06	-8.632E-03	3.713E+00
5144	37.8	(°)	5.51	8.351E-06	-8.632E-03	3.713E+00
5145	36.4	(°)	5.42	8.351E-06	-8.632E-03	3.713E+00
5146	36.8	3.3	5.44	8.351E-06	-8.632E-03	3.713E+00
5147	41.2	2.4	5.7	8.351E-06	-8.632E-03	3.713E+00
5148	44.7	3.9	5.9	8.351E-06	-8.632E-03	3.713E+00
5149	50.1	5.6	6.21	8.351E-06	-8.632E-03	3.713E+00
5150	57.9	2.6	6.65	2.784E-06	-2.877E-03	1.238E+00
5151	57.9	12.3	6.84	-2.784E-06	2.877E-03	-1.238E+00
5152	24.4	(°)	6.54	-8.351E-06	8.632E-03	-3.713E+00
5153	16.9	1	5.94	-8.351E-06	8.632E-03	-3.713E+00
5154	10.7	0.7	5.45	-8.351E-06	8.632E-03	-3.713E+00
5155	28.2	16.1	4.74	-8.351E-06	8.632E-03	-3.713E+00
5156	5.3	1	3.66	-8.351E-06	8.632E-03	-3.713E+00
5157	0.1	6	2.44	-8.351E-06	8.632E-03	-3.713E+00
5158	0	0	1.55	-8.351E-06	8.632E-03	-3.713E+00
5159	0	0	1.16	-8.351E-06	8.632E-03	-3.713E+00
5160	0.4	5.8	0.82	-8.351E-06	8.632E-03	-3.713E+00
5161	1.4	9.5	0.52	-2.558E-06	2.662E-03	-1.372E+00
5162	6.2	28.4	0.59	3.235E-06	-3.307E-03	9.693E-01
5163	6.8	41	1.18	9.029E-06	-9.277E-03	3.311E+00
5164	5.7	34.4	2.06	9.029E-06	-9.277E-03	3.311E+00
5165	5.4	23.3	2.3	9.029E-06	-9.277E-03	3.311E+00
5166	5.9	22.2	2.34	9.029E-06	-9.277E-03	3.311E+00
5167	6.1	21.1	2.39	9.029E-06	-9.277E-03	3.311E+00
5168	6.2	19.5	2.45	9.029E-06	-9.277E-03	3.311E+00
5169	6.4	20.2	2.42	9.029E-06	-9.277E-03	3.311E+00
5170	6.9	29.3	2.28	9.029E-06	-9.277E-03	3.311E+00
5171	6	18.2	2.49	9.029E-06	-9.277E-03	3.311E+00
5172	6.7	26.6	2.37	9.029E-06	-9.277E-03	3.311E+00
5173	5.8	13.1	2.67	9.029E-06	-9.277E-03	3.311E+00
5174	7	10.2	2.73	9.029E-06	-9.277E-03	3.311E+00
5175	7.4	9.2	2.75	9.029E-06	-9.277E-03	3.311E+00
5176	7.5	9	2.75	9.029E-06	-9.277E-03	3.311E+00
5177	7.5	8.8	2.75	9.029E-06	-9.277E-03	3.311E+00
5178	7.5	8.8	2.75	9.029E-06	-9.277E-03	3.311E+00
5179	8.7	16.8	2.8	9.029E-06	-9.277E-03	3.311E+00
5180	20.1	20.7	3.27	9.029E-06	-9.277E-03	3.311E+00
5181	33.4	16	3.83	9.029E-06	-9.277E-03	3.311E+00
5182	49.7	13.4	4.51	9.029E-06	-9.277E-03	3.311E+00

5183	57.2	6.8	4.83	9.029E-06	-9.277E-03	3.311E+00
5184	26.8	1	4.73	9.029E-06	-9.277E-03	3.311E+00
5185	21.1	24.2	4.54	9.029E-06	-9.277E-03	3.311E+00
5186	25.4	14	4.79	9.029E-06	-9.277E-03	3.311E+00
5187	26.1	11.9	4.83	9.029E-06	-9.277E-03	3.311E+00
5188	28	7.4	4.94	9.029E-06	-9.277E-03	3.311E+00
5189	28.5	6	4.97	9.029E-06	-9.277E-03	3.311E+00
5190	28.5	5.7	4.97	9.029E-06	-9.277E-03	3.311E+00
5191	28.4	5.6	4.96	9.029E-06	-9.277E-03	3.311E+00
5192	28.2	5.6	4.95	9.029E-06	-9.277E-03	3.311E+00
5193	28.1	5.6	4.94	9.029E-06	-9.277E-03	3.311E+00
5194	27.9	5.7	4.94	9.029E-06	-9.277E-03	3.311E+00
5195	29.5	14.7	5.02	9.029E-06	-9.277E-03	3.311E+00
5196	40.8	21.2	5.66	9.029E-06	-9.277E-03	3.311E+00
5197	56.3	21.8	6.54	9.029E-06	-9.277E-03	3.311E+00
5198	68.3	13.8	7.24	9.029E-06	-9.277E-03	3.311E+00
5199	33.3	2.8	7.05	9.029E-06	-9.277E-03	3.311E+00
5200	42.1	40.5	7.9	9.029E-06	-9.277E-03	3.311E+00
5201	59.3	19.7	9.27	9.029E-06	-9.277E-03	3.311E+00
5202	67.3	9.5	9.92	9.029E-06	-9.277E-03	3.311E+00
5203	38.3	0.5	10.23	9.029E-06	-9.277E-03	3.311E+00
5204	42.7	37	10.89	9.029E-06	-9.277E-03	3.311E+00
5205	49.4	19.3	11.64	9.029E-06	-9.277E-03	3.311E+00
5206	56.8	10.7	12.44	9.029E-06	-9.277E-03	3.311E+00
5207	63.5	24.7	13.15	9.029E-06	-9.277E-03	3.311E+00
5208	42.4	13.5	13.24	9.029E-06	-9.277E-03	3.311E+00
5209	25.9	51.3	12.47	9.029E-06	-9.277E-03	3.311E+00
5210	30.8	72.4	13.18	9.029E-06	-9.277E-03	3.311E+00
5211	38.7	13.4	14.38	3.010E-06	-3.092E-03	1.104E+00
5212	38	(°)	14.3	-3.010E-06	3.092E-03	-1.104E+00
5213	31.1	(°)	13.3	-9.029E-06	9.277E-03	-3.311E+00
5214	18.8	(°)	11.48	-9.029E-06	9.277E-03	-3.311E+00
5215	9.7	17.8	9.06	-9.029E-06	9.277E-03	-3.311E+00
5216	2.1	0.2	6.13	-9.029E-06	9.277E-03	-3.311E+00
5217	0.1	5.8	3.32	-9.029E-06	9.277E-03	-3.311E+00
5218	0	0	1.29	-9.029E-06	9.277E-03	-3.311E+00
5219	0	0	0.34	-9.029E-06	9.277E-03	-3.311E+00
5220	0	0	0	-9.029E-06	9.277E-03	-3.311E+00
5249	0	0	0	-9.029E-06	9.277E-03	-3.311E+00
5250	0	0	0	-7.324E-07	8.211E-04	-3.593E-01
5251	0	0	0	7.564E-06	-7.634E-03	2.592E+00
5252	0	0	0	1.586E-05	-1.609E-02	5.543E+00
5282	0	0	0	1.586E-05	-1.609E-02	5.543E+00
5283	0.8	9.8	0	1.586E-05	-1.609E-02	5.543E+00
5284	6.6	37.6	0.49	1.586E-05	-1.609E-02	5.543E+00
5285	6.5	41.8	1.56	1.586E-05	-1.609E-02	5.543E+00
5286	5.7	27.5	2.36	1.586E-05	-1.609E-02	5.543E+00
5287	5.4	14.6	2.62	1.586E-05	-1.609E-02	5.543E+00
5288	4.3	4.8	2.35	1.586E-05	-1.609E-02	5.543E+00
5289	0	0	1.8	1.586E-05	-1.609E-02	5.543E+00
5290	0	0	0.99	1.586E-05	-1.609E-02	5.543E+00
5291	0	0	0.2	1.586E-05	-1.609E-02	5.543E+00
5292	1.8	9.6	0	1.586E-05	-1.609E-02	5.543E+00
5293	7.7	54.2	0.41	1.586E-05	-1.609E-02	5.543E+00
5294	7.2	74	2.08	1.586E-05	-1.609E-02	5.543E+00
5295	26.2	44	3.52	1.586E-05	-1.609E-02	5.543E+00
5296	56.6	26.2	4.78	1.586E-05	-1.609E-02	5.543E+00
5297	41.1	15.5	4.94	1.586E-05	-1.609E-02	5.543E+00
5298	15.7	3.7	4.03	1.586E-05	-1.609E-02	5.543E+00
5299	25.6	54.8	4.78	1.586E-05	-1.609E-02	5.543E+00
5300	58.4	41.3	6.64	1.586E-05	-1.609E-02	5.543E+00
5301	79.3	27.1	7.86	1.586E-05	-1.609E-02	5.543E+00
5302	45	0.8	7.98	1.586E-05	-1.609E-02	5.543E+00
5303	52.4	49	8.7	1.586E-05	-1.609E-02	5.543E+00
5304	84.7	84.8	11.22	1.586E-05	-1.609E-02	5.543E+00
5305	85.6	30.4	12.14	1.586E-05	-1.609E-02	5.543E+00
5306	47.3	2.8	11.42	1.586E-05	-1.609E-02	5.543E+00
5307	52.6	65.9	11.95	1.586E-05	-1.609E-02	5.543E+00
5308	67.5	87.5	13.53	1.586E-05	-1.609E-02	5.543E+00
5309	85.6	57.5	15.51	1.586E-05	-1.609E-02	5.543E+00
5310	92.5	52	16.26	1.586E-05	-1.609E-02	5.543E+00
5311	67.3	17.9	16.49	1.586E-05	-1.609E-02	5.543E+00

5312	50.8	39.2	16.16	1.586E-05	-1.609E-02	5.543E+00
5313	54.7	74.5	16.7	1.586E-05	-1.609E-02	5.543E+00
5314	61.2	90.7	17.65	1.586E-05	-1.609E-02	5.543E+00
5315	70.6	97	19.03	1.586E-05	-1.609E-02	5.543E+00
5316	82.2	95.2	20.76	1.586E-05	-1.609E-02	5.543E+00
5317	90.7	33.2	22.06	1.586E-05	-1.609E-02	5.543E+00
5318	53	2.5	22.66	1.586E-05	-1.609E-02	5.543E+00
5319	58.2	62	23.82	1.586E-05	-1.609E-02	5.543E+00
5320	64.7	43.3	25.15	1.586E-05	-1.609E-02	5.543E+00
5321	68.1	53.2	25.84	1.586E-05	-1.609E-02	5.543E+00
5322	70.3	80.1	26.27	1.586E-05	-1.609E-02	5.543E+00
5323	73.6	35	26.99	1.586E-05	-1.609E-02	5.543E+00
5324	74.1	26.3	27.09	1.586E-05	-1.609E-02	5.543E+00
5325	43.6	7.6	26.9	5.287E-06	-5.363E-03	1.848E+00
5326	37.1	12.3	26.76	-5.287E-06	5.363E-03	-1.848E+00
5327	35.9	8.2	26.41	-1.586E-05	1.609E-02	-5.543E+00
5328	34.1	(°)	25.95	-1.586E-05	1.609E-02	-5.543E+00
5329	30.2	(°)	24.87	-1.586E-05	1.609E-02	-5.543E+00
5330	23.3	(°)	23	-1.586E-05	1.609E-02	-5.543E+00
5331	14.2	(°)	20.44	-1.586E-05	1.609E-02	-5.543E+00
5332	30.7	1.7	17.84	-1.586E-05	1.609E-02	-5.543E+00
5333	19.7	(°)	16	-1.586E-05	1.609E-02	-5.543E+00
5334	15.1	12.6	15.03	-1.586E-05	1.609E-02	-5.543E+00
5335	43.1	5.7	14.64	-1.586E-05	1.609E-02	-5.543E+00
5336	39.2	(°)	14.48	-1.586E-05	1.609E-02	-5.543E+00
5337	35.7	(°)	13.98	-1.586E-05	1.609E-02	-5.543E+00
5338	30.1	(°)	13.14	-1.586E-05	1.609E-02	-5.543E+00
5339	24.4	(°)	12.28	-1.586E-05	1.609E-02	-5.543E+00
5340	21.6	(°)	11.86	-1.586E-05	1.609E-02	-5.543E+00
5341	21.3	(°)	11.81	-1.586E-05	1.609E-02	-5.543E+00
5342	20.1	4.4	11.62	-1.586E-05	1.609E-02	-5.543E+00
5343	20.1	10	11.63	-1.586E-05	1.609E-02	-5.543E+00
5344	20.4	6.1	11.67	-1.586E-05	1.609E-02	-5.543E+00
5345	19.1	(°)	11.48	-1.586E-05	1.609E-02	-5.543E+00
5346	16	(°)	11.03	-1.586E-05	1.609E-02	-5.543E+00
5347	12.8	(°)	10.54	-1.586E-05	1.609E-02	-5.543E+00
5348	9.4	(°)	10.04	-1.586E-05	1.609E-02	-5.543E+00
5349	8.4	(°)	9.9	-1.586E-05	1.609E-02	-5.543E+00
5350	8.2	(°)	9.88	-1.586E-05	1.609E-02	-5.543E+00
5351	32.6	20.1	9.63	-1.586E-05	1.609E-02	-5.543E+00
5352	27.9	(°)	9.32	-5.287E-06	5.363E-03	-1.848E+00
5353	26.6	20.9	9.18	5.287E-06	-5.363E-03	1.848E+00
5354	30.9	32	9.62	1.326E-05	-1.356E-02	4.569E+00
5355	33.2	21.5	9.89	1.065E-05	-1.104E-02	3.596E+00
5356	32.4	2.7	9.8	8.046E-06	-8.510E-03	2.622E+00
5357	34.7	19.6	10.04	8.046E-06	-8.510E-03	2.622E+00
5358	46.7	35.6	11.32	8.046E-06	-8.510E-03	2.622E+00
5359	61.8	44.7	12.94	8.046E-06	-8.510E-03	2.622E+00
5360	74.1	43.8	14.28	8.046E-06	-8.510E-03	2.622E+00
5361	79.1	27.1	14.83	8.046E-06	-8.510E-03	2.622E+00
5362	40	3	14.23	8.046E-06	-8.510E-03	2.622E+00
5363	38.7	58.8	14.35	8.046E-06	-8.510E-03	2.622E+00
5364	47	81.8	15.55	8.046E-06	-8.510E-03	2.622E+00
5365	59.3	92.7	17.36	8.046E-06	-8.510E-03	2.622E+00
5366	72.4	96.5	19.31	8.046E-06	-8.510E-03	2.622E+00
5367	80.9	50.4	20.61	8.046E-06	-8.510E-03	2.622E+00
5368	85.8	58	21.33	8.046E-06	-8.510E-03	2.622E+00
5369	47.8	0.5	21.32	8.046E-06	-8.510E-03	2.622E+00
5370	47.6	52.3	21.65	8.046E-06	-8.510E-03	2.622E+00
5371	52.8	81.7	22.7	8.046E-06	-8.510E-03	2.622E+00
5372	59.2	93.4	23.98	8.046E-06	-8.510E-03	2.622E+00
5373	65.5	98.3	25.28	8.046E-06	-8.510E-03	2.622E+00
5374	72.3	98.2	26.67	8.046E-06	-8.510E-03	2.622E+00
5375	75.3	21.6	27.33	8.046E-06	-8.510E-03	2.622E+00
5376	76.1	42.7	27.48	8.046E-06	-8.510E-03	2.622E+00
5377	40	1.5	27.03	8.046E-06	-8.510E-03	2.622E+00
5378	38.4	58.3	27.09	8.046E-06	-8.510E-03	2.622E+00
5379	40.8	83.1	27.75	8.046E-06	-8.510E-03	2.622E+00
5380	43.6	92.9	28.53	8.046E-06	-8.510E-03	2.622E+00
5381	46.7	96.7	29.38	8.046E-06	-8.510E-03	2.622E+00
5382	50.1	98.4	30.32	8.046E-06	-8.510E-03	2.622E+00
5383	53	99.3	31.15	8.046E-06	-8.510E-03	2.622E+00

5384	56.2	99	32.05	8.046E-06	-8.510E-03	2.622E+00
5385	59.9	58.3	33.11	8.046E-06	-8.510E-03	2.622E+00
5386	61.8	38.7	33.66	8.046E-06	-8.510E-03	2.622E+00
5387	62.9	41	33.95	8.046E-06	-8.510E-03	2.622E+00
5388	30.9	1.4	33.81	8.046E-06	-8.510E-03	2.622E+00
5389	29.2	64.2	33.85	8.046E-06	-8.510E-03	2.622E+00
5390	29.7	86	34.03	8.046E-06	-8.510E-03	2.622E+00
5391	30.5	93.5	34.31	8.046E-06	-8.510E-03	2.622E+00
5392	31.4	60	34.69	8.046E-06	-8.510E-03	2.622E+00
5393	31.8	34.9	34.86	8.046E-06	-8.510E-03	2.622E+00
5394	31.6	45.6	34.78	8.046E-06	-8.510E-03	2.622E+00
5395	31.8	45.8	34.83	2.682E-06	-2.837E-03	8.740E-01
5396	31.8	(°)	34.87	-2.682E-06	2.837E-03	-8.740E-01
5397	30.6	(°)	34.44	-8.046E-06	8.510E-03	-2.622E+00
5398	29.4	4.1	33.94	-8.046E-06	8.510E-03	-2.622E+00
5399	28.4	(°)	33.58	-8.046E-06	8.510E-03	-2.622E+00
5400	27.6	(°)	33.26	-8.046E-06	8.510E-03	-2.622E+00
5401	26.6	4.6	32.87	-8.046E-06	8.510E-03	-2.622E+00
5402	26	(°)	32.62	-8.046E-06	8.510E-03	-2.622E+00
5403	25	14.2	32.25	-8.046E-06	8.510E-03	-2.622E+00
5404	24.4	8.2	32.02	-8.046E-06	8.510E-03	-2.622E+00
5405	24.1	(°)	31.92	-8.046E-06	8.510E-03	-2.622E+00
5406	23.2	(°)	31.57	-8.046E-06	8.510E-03	-2.622E+00
5407	22.5	(°)	31.29	-8.046E-06	8.510E-03	-2.622E+00
5408	21.8	(°)	31	-8.046E-06	8.510E-03	-2.622E+00
5409	20.6	9.5	30.56	-8.046E-06	8.510E-03	-2.622E+00
5410	19.6	4.5	30.15	-8.046E-06	8.510E-03	-2.622E+00
5411	18.7	(°)	29.81	-8.046E-06	8.510E-03	-2.622E+00
5412	18	(°)	29.56	-8.046E-06	8.510E-03	-2.622E+00
5413	16.5	(°)	28.96	-8.046E-06	8.510E-03	-2.622E+00
5414	17.2	13.8	28.18	-8.046E-06	8.510E-03	-2.622E+00
5415	40.8	2.2	27.26	-8.046E-06	8.510E-03	-2.622E+00
5416	36.4	(°)	26.59	-8.046E-06	8.510E-03	-2.622E+00
5417	34.8	(°)	26.13	-8.046E-06	8.510E-03	-2.622E+00
5418	33.5	(°)	25.76	-8.046E-06	8.510E-03	-2.622E+00
5419	31.7	(°)	25.28	-8.046E-06	8.510E-03	-2.622E+00
5420	27.1	(°)	24	-8.046E-06	8.510E-03	-2.622E+00
5421	20	(°)	22.03	-8.046E-06	8.510E-03	-2.622E+00
5422	26.2	22.1	19.59	-8.046E-06	8.510E-03	-2.622E+00
5423	25.5	7.2	16.5	-8.046E-06	8.510E-03	-2.622E+00
5424	33.7	15.3	13.16	-8.046E-06	8.510E-03	-2.622E+00
5425	15.9	(°)	11.03	-8.046E-06	8.510E-03	-2.622E+00
5426	10.8	(°)	10.25	-8.046E-06	8.510E-03	-2.622E+00
5427	9.4	6.8	10.04	-2.682E-06	2.837E-03	-8.740E-01
5428	11	45	10.27	2.682E-06	-2.837E-03	8.740E-01
5429	15.6	61.7	10.94	8.046E-06	-8.510E-03	2.622E+00
5430	20.1	44.6	11.62	8.046E-06	-8.510E-03	2.622E+00
5431	23.1	47	12.06	8.046E-06	-8.510E-03	2.622E+00
5432	27	43	12.63	8.046E-06	-8.510E-03	2.622E+00
5433	31.6	43.2	13.3	8.046E-06	-8.510E-03	2.622E+00
5434	36.1	33	13.98	8.046E-06	-8.510E-03	2.622E+00
5435	38.7	21	14.38	8.046E-06	-8.510E-03	2.622E+00
5436	41.9	36.1	14.84	8.046E-06	-8.510E-03	2.622E+00
5437	47.2	48.6	15.6	8.046E-06	-8.510E-03	2.622E+00
5438	55.4	69.9	16.8	8.046E-06	-8.510E-03	2.622E+00
5439	65.4	71.9	18.28	8.046E-06	-8.510E-03	2.622E+00
5440	72.7	55	19.38	8.046E-06	-8.510E-03	2.622E+00
5441	76.7	33.4	19.99	8.046E-06	-8.510E-03	2.622E+00
5442	41.3	1.5	19.89	8.046E-06	-8.510E-03	2.622E+00
5443	39.1	49.6	19.92	8.046E-06	-8.510E-03	2.622E+00
5444	44	79.4	20.89	8.046E-06	-8.510E-03	2.622E+00
5445	50.2	58	22.17	8.046E-06	-8.510E-03	2.622E+00
5446	53.4	43.9	22.85	8.046E-06	-8.510E-03	2.622E+00
5447	56.3	52.2	23.42	8.046E-06	-8.510E-03	2.622E+00
5448	60.4	67.4	24.25	8.046E-06	-8.510E-03	2.622E+00
5449	64.7	61.3	25.14	8.046E-06	-8.510E-03	2.622E+00
5450	68	51.4	25.82	8.046E-06	-8.510E-03	2.622E+00
5451	70.9	50.6	26.43	8.046E-06	-8.510E-03	2.622E+00
5452	41	6.3	26.52	8.046E-06	-8.510E-03	2.622E+00
5453	36.5	46.3	26.57	8.046E-06	-8.510E-03	2.622E+00
5454	38	57.7	26.99	8.046E-06	-8.510E-03	2.622E+00
5455	39.9	59.5	27.49	8.046E-06	-8.510E-03	2.622E+00



5456	41.9	65.2	28.07	8.046E-06	-8.510E-03	2.622E+00
5457	44.4	77.2	28.74	8.046E-06	-8.510E-03	2.622E+00
5458	46.9	69.5	29.45	8.046E-06	-8.510E-03	2.622E+00
5459	48.7	48.9	29.97	8.046E-06	-8.510E-03	2.622E+00
5460	49.9	38.1	30.32	8.046E-06	-8.510E-03	2.622E+00
5461	50.3	19.6	30.43	8.046E-06	-8.510E-03	2.622E+00
5462	49.5	( <sup>a</sup> )	30.26	8.046E-06	-8.510E-03	2.622E+00
5463	48.2	( <sup>a</sup> )	29.88	2.682E-06	-2.837E-03	8.740E-01
5464	46.6	( <sup>a</sup> )	29.44	-2.682E-06	2.837E-03	-8.740E-01
5465	45.3	( <sup>a</sup> )	29.06	-8.046E-06	8.510E-03	-2.622E+00
5466	43.5	( <sup>a</sup> )	28.59	-8.046E-06	8.510E-03	-2.622E+00
5467	40.3	( <sup>a</sup> )	27.7	-8.046E-06	8.510E-03	-2.622E+00
5468	35.8	( <sup>a</sup> )	26.44	-8.046E-06	8.510E-03	-2.622E+00
5469	32.1	( <sup>a</sup> )	25.39	-8.046E-06	8.510E-03	-2.622E+00
5470	28.4	( <sup>a</sup> )	24.37	-8.046E-06	8.510E-03	-2.622E+00
5471	22.8	( <sup>a</sup> )	22.82	-8.046E-06	8.510E-03	-2.622E+00
5472	14.5	6.3	20.09	-8.046E-06	8.510E-03	-2.622E+00
5473	22.7	( <sup>a</sup> )	16.17	-8.046E-06	8.510E-03	-2.622E+00
5474	27.5	8.8	12.18	-8.046E-06	8.510E-03	-2.622E+00
5475	6.4	3.7	9.5	-8.046E-06	8.510E-03	-2.622E+00
5476	20.7	( <sup>a</sup> )	8.26	-8.046E-06	8.510E-03	-2.622E+00
5477	13.7	( <sup>a</sup> )	7.79	-8.046E-06	8.510E-03	-2.622E+00
5478	9.9	( <sup>a</sup> )	7.38	-8.046E-06	8.510E-03	-2.622E+00
5479	0	0	6.77	-8.046E-06	8.510E-03	-2.622E+00
5480	0	0	6.1	-8.046E-06	8.510E-03	-2.622E+00
5481	0	0	5.44	-8.046E-06	8.510E-03	-2.622E+00
5482	0	0	5.21	-8.046E-06	8.510E-03	-2.622E+00
5483	0.7	5.9	5.25	-8.046E-06	8.510E-03	-2.622E+00
5484	36.3	46.1	5.77	-8.046E-06	8.510E-03	-2.622E+00
5485	34.1	( <sup>a</sup> )	5.3	-8.046E-06	8.510E-03	-2.622E+00
5486	26.5	( <sup>a</sup> )	4.86	-8.046E-06	8.510E-03	-2.622E+00
5487	20.6	2.3	4.52	-8.046E-06	8.510E-03	-2.622E+00
5488	16	( <sup>a</sup> )	4.26	-8.046E-06	8.510E-03	-2.622E+00
5489	10.2	( <sup>a</sup> )	3.93	-8.046E-06	8.510E-03	-2.622E+00
5490	0	0	3.43	-8.046E-06	8.510E-03	-2.622E+00
5491	0	0	2.99	-8.046E-06	8.510E-03	-2.622E+00
5492	0	0	3.03	-8.046E-06	8.510E-03	-2.622E+00
5493	0	0	2.99	-8.046E-06	8.510E-03	-2.622E+00
5494	0	0	2.61	-8.046E-06	8.510E-03	-2.622E+00
5495	0	0	2.22	-8.046E-06	8.510E-03	-2.622E+00
5496	0	0	1.85	-8.046E-06	8.510E-03	-2.622E+00
5497	0	0	1.69	-8.046E-06	8.510E-03	-2.622E+00
5498	0	0	1.59	-8.046E-06	8.510E-03	-2.622E+00
5499	0	0	1.57	-8.046E-06	8.510E-03	-2.622E+00
5500	0	0	1.59	-8.046E-06	8.510E-03	-2.622E+00
5501	0	0	1.45	-8.046E-06	8.510E-03	-2.622E+00
5502	0	0	1.09	-8.046E-06	8.510E-03	-2.622E+00
5503	0	0	0.62	-8.046E-06	8.510E-03	-2.622E+00
5504	0	0	0.27	-8.046E-06	8.510E-03	-2.622E+00
5505	0	0	0	-8.046E-06	8.510E-03	-2.622E+00

<sup>a</sup>Closed throttle motoring.

**Appendix C of Part 1036—Default Engine Fuel Maps for § 1036.540**

GEM contains the default steady-state fuel maps in this appendix for performing cycle-average engine fuel mapping as described in

§ 1036.505(b)(2). Note that manufacturers have the option to replace these default values in GEM if they generate a steady-state fuel map as described in § 1036.535(b).

(a) Use the following default fuel map for compression-ignition engines that will be

installed in Tractors and Vocational Heavy HDV:

**Table 1 of Appendix C—Default Fuel Map for Compression-Ignition Engines Installed in Tractors and Vocational Heavy HDV**

Engine Speed (r/min)	Engine Torque (N·m)	Fuel Mass Rate (g/sec)
666.7	0	0.436
833.3	0	0.665
1000.0	0	0.94
1166.7	0	1.002
1333.3	0	1.17
1500.0	0	1.5
1666.7	0	1.899
1833.3	0	2.378
2000.0	0	2.93
2166.7	0	3.516
2333.3	0	4.093
2500.0	0	4.672
500.0	300	0.974
666.7	300	1.405
833.3	300	1.873
1000.0	300	2.324
1166.7	300	2.598
1333.3	300	2.904
1500.0	300	3.397
1666.7	300	3.994
1833.3	300	4.643
2000.0	300	5.372
2166.7	300	6.141
2333.3	300	7.553
2500.0	300	8.449
500.0	600	1.723
666.7	600	2.391
833.3	600	3.121
1000.0	600	3.756
1166.7	600	4.197
1333.3	600	4.776
1500.0	600	5.492
1666.7	600	6.277
1833.3	600	7.129
2000.0	600	8.069
2166.7	600	9.745
2333.3	600	11.213
2500.0	600	12.59
500.0	900	2.637
666.7	900	3.444
833.3	900	4.243
1000.0	900	4.997
1166.7	900	5.802
1333.3	900	6.702
1500.0	900	7.676
1666.7	900	8.7

1833.3	900	9.821
2000.0	900	11.08
2166.7	900	13.051
2333.3	900	15.002
2500.0	900	16.862
500.0	1200	3.833
666.7	1200	4.679
833.3	1200	5.535
1000.0	1200	6.519
1166.7	1200	7.603
1333.3	1200	8.735
1500.0	1200	9.948
1666.7	1200	11.226
1833.3	1200	12.622
2000.0	1200	14.228
2166.7	1200	16.488
2333.3	1200	18.921
2500.0	1200	21.263
500.0	1500	6.299
666.7	1500	6.768
833.3	1500	6.95
1000.0	1500	8.096
1166.7	1500	9.399
1333.3	1500	10.764
1500.0	1500	12.238
1666.7	1500	13.827
1833.3	1500	15.586
2000.0	1500	17.589
2166.7	1500	20.493
2333.3	1500	23.366
2500.0	1500	26.055
500.0	1800	9.413
666.7	1800	9.551
833.3	1800	8.926
1000.0	1800	9.745
1166.7	1800	11.26
1333.3	1800	12.819
1500.0	1800	14.547
1666.7	1800	16.485
1833.3	1800	18.697
2000.0	1800	21.535
2166.7	1800	24.981
2333.3	1800	28.404
2500.0	1800	31.768
500.0	2100	13.128
666.7	2100	12.936
833.3	2100	12.325
1000.0	2100	11.421
1166.7	2100	13.174

1333.3	2100	14.969
1500.0	2100	16.971
1666.7	2100	19.274
1833.3	2100	22.09
2000.0	2100	25.654
2166.7	2100	29.399
2333.3	2100	32.958
2500.0	2100	36.543
500.0	2400	17.446
666.7	2400	16.922
833.3	2400	15.981
1000.0	2400	14.622
1166.7	2400	15.079
1333.3	2400	17.165
1500.0	2400	19.583
1666.7	2400	22.408
1833.3	2400	25.635
2000.0	2400	29.22
2166.7	2400	33.168
2333.3	2400	37.233
2500.0	2400	41.075
500.0	2700	22.365
666.7	2700	21.511
833.3	2700	20.225
1000.0	2700	17.549
1166.7	2700	17.131
1333.3	2700	19.588
1500.0	2700	22.514
1666.7	2700	25.574
1833.3	2700	28.909
2000.0	2700	32.407
2166.7	2700	36.18
2333.3	2700	40.454
2500.0	2700	44.968
500.0	3000	27.476
666.7	3000	22.613
833.3	3000	19.804
1000.0	3000	17.266
1166.7	3000	19.197
1333.3	3000	22.109
1500.0	3000	25.288
1666.7	3000	28.44
1833.3	3000	31.801
2000.0	3000	35.405
2166.7	3000	39.152
2333.3	3000	42.912
2500.0	3000	47.512

(b) Use the following default fuel map for compression-ignition engines that will be installed in Vocational Light HDV and Vocational Medium HDV:

**Table 2 of Appendix C—Default Fuel Map for Compression-Ignition Engines Installed in Vocational Light HDV and Vocational Medium HDV**

Engine Speed (r/min)	Engine Torque (N·m)	Fuel Mass Rate (g/sec)
708.3	0	0.255
916.7	0	0.263
1125.0	0	0.342
1333.3	0	0.713
1541.7	0	0.885
1750.0	0	1.068
1958.3	0	1.27
2166.7	0	1.593
2375.0	0	1.822
2583.3	0	2.695
2791.7	0	4.016
3000.0	0	5.324
500.0	120	0.515
708.3	120	0.722
916.7	120	0.837
1125.0	120	1.097
1333.3	120	1.438
1541.7	120	1.676
1750.0	120	1.993
1958.3	120	2.35
2166.7	120	2.769
2375.0	120	3.306
2583.3	120	4.004
2791.7	120	4.78
3000.0	120	5.567
500.0	240	0.862
708.3	240	1.158
916.7	240	1.462
1125.0	240	1.85
1333.3	240	2.246
1541.7	240	2.603
1750.0	240	3.086
1958.3	240	3.516
2166.7	240	4.093
2375.0	240	4.726
2583.3	240	5.372
2791.7	240	6.064
3000.0	240	6.745
500.0	360	1.221
708.3	360	1.651
916.7	360	2.099
1125.0	360	2.62
1333.3	360	3.116
1541.7	360	3.604
1750.0	360	4.172
1958.3	360	4.754

2166.7	360	5.451
2375.0	360	6.16
2583.3	360	7.009
2791.7	360	8.007
3000.0	360	8.995
500.0	480	1.676
708.3	480	2.194
916.7	480	2.76
1125.0	480	3.408
1333.3	480	4.031
1541.7	480	4.649
1750.0	480	5.309
1958.3	480	6.052
2166.7	480	6.849
2375.0	480	7.681
2583.3	480	8.783
2791.7	480	10.073
3000.0	480	11.36
500.0	600	2.147
708.3	600	2.787
916.7	600	3.478
1125.0	600	4.227
1333.3	600	4.999
1541.7	600	5.737
1750.0	600	6.511
1958.3	600	7.357
2166.7	600	8.289
2375.0	600	9.295
2583.3	600	10.541
2791.7	600	11.914
3000.0	600	13.286
500.0	720	2.744
708.3	720	3.535
916.7	720	4.356
1125.0	720	5.102
1333.3	720	5.968
1541.7	720	6.826
1750.0	720	7.733
1958.3	720	8.703
2166.7	720	9.792
2375.0	720	10.984
2583.3	720	12.311
2791.7	720	13.697
3000.0	720	15.071
500.0	840	3.518
708.3	840	4.338
916.7	840	5.186
1125.0	840	6.063
1333.3	840	6.929

1541.7	840	7.883
1750.0	840	8.94
1958.3	840	10.093
2166.7	840	11.329
2375.0	840	12.613
2583.3	840	13.983
2791.7	840	15.419
3000.0	840	16.853
500.0	960	4.251
708.3	960	5.098
916.7	960	5.974
1125.0	960	6.917
1333.3	960	7.889
1541.7	960	8.913
1750.0	960	10.152
1958.3	960	11.482
2166.7	960	12.87
2375.0	960	14.195
2583.3	960	15.562
2791.7	960	16.995
3000.0	960	18.492
500.0	1080	4.978
708.3	1080	5.928
916.7	1080	6.877
1125.0	1080	7.827
1333.3	1080	8.838
1541.7	1080	9.91
1750.0	1080	11.347
1958.3	1080	12.85
2166.7	1080	14.398
2375.0	1080	15.745
2583.3	1080	17.051
2791.7	1080	18.477
3000.0	1080	19.971
500.0	1200	5.888
708.3	1200	6.837
916.7	1200	7.787
1125.0	1200	8.736
1333.3	1200	9.786
1541.7	1200	10.908
1750.0	1200	12.541
1958.3	1200	14.217
2166.7	1200	15.925
2375.0	1200	17.3
2583.3	1200	18.606
2791.7	1200	19.912
3000.0	1200	21.357

(c) Use the following default fuel map for all spark-ignition engines:

**Table 3 of Appendix C—Default Fuel Map for Spark-Ignition Engines**

Engine Speed (r/min)	Engine Torque (N·m)	Fuel Mass Rate (g/sec)
875	0	0.535
1250	0	0.734
1625	0	0.975
2000	0	1.238
2375	0	1.506
2750	0	1.772
3125	0	2.070
3500	0	2.394
3875	0	2.795
4250	0	3.312
4625	0	3.349
5000	0	3.761
500	65	0.458
875	65	0.759
1250	65	1.065
1625	65	1.430
2000	65	1.812
2375	65	2.220
2750	65	2.650
3125	65	3.114
3500	65	3.646
3875	65	4.225
4250	65	4.861
4625	65	5.328
5000	65	6.028
500	130	0.666
875	130	1.063
1250	130	1.497
1625	130	1.976
2000	130	2.469
2375	130	3.015
2750	130	3.590
3125	130	4.218
3500	130	4.900
3875	130	5.652
4250	130	6.484
4625	130	7.308
5000	130	8.294
500	195	0.856
875	195	1.377
1250	195	1.923
1625	195	2.496
2000	195	3.111
2375	195	3.759
2750	195	4.490
3125	195	5.269

3500	195	6.130
3875	195	7.124
4250	195	8.189
4625	195	9.288
5000	195	10.561
500	260	1.079
875	260	1.716
1250	260	2.373
1625	260	3.083
2000	260	3.832
2375	260	4.599
2750	260	5.443
3125	260	6.391
3500	260	7.444
3875	260	8.564
4250	260	9.821
4625	260	11.268
5000	260	12.828
500	325	1.354
875	325	2.060
1250	325	2.844
1625	325	3.696
2000	325	4.579
2375	325	5.466
2750	325	6.434
3125	325	7.542
3500	325	8.685
3875	325	9.768
4250	325	11.011
4625	325	13.249
5000	325	15.095
500	390	1.609
875	390	2.440
1250	390	3.317
1625	390	4.310
2000	390	5.342
2375	390	6.362
2750	390	7.489
3125	390	8.716
3500	390	9.865
3875	390	10.957
4250	390	12.405
4625	390	15.229
5000	390	17.363
500	455	2.245
875	455	2.969
1250	455	3.867
1625	455	4.992
2000	455	6.215

2375	455	7.415
2750	455	8.760
3125	455	10.175
3500	455	11.530
3875	455	12.889
4250	455	14.686
4625	455	17.243
5000	455	19.633
500	520	3.497
875	520	4.444
1250	520	5.084
1625	520	5.764
2000	520	7.205
2375	520	8.597
2750	520	10.135
3125	520	11.708
3500	520	12.962
3875	520	14.225
4250	520	15.647
4625	520	17.579
5000	520	20.031
500	585	5.179
875	585	5.962
1250	585	5.800
1625	585	6.341
2000	585	7.906
2375	585	9.452
2750	585	10.979
3125	585	13.019
3500	585	13.966
3875	585	15.661
4250	585	16.738
4625	585	17.935
5000	585	19.272
500	650	6.834
875	650	7.316
1250	650	5.632
1625	650	6.856
2000	650	8.471
2375	650	10.068
2750	650	11.671
3125	650	14.655
3500	650	14.804
3875	650	16.539
4250	650	18.415
4625	650	19.152
5000	650	20.330

**PART 1037—CONTROL OF EMISSIONS FROM NEW HEAVY-DUTY MOTOR VEHICLES**

■ 93. The authority citation for part 1037 continues to read as follows:

Authority: 42 U.S.C. 7401—7671q.

**Subpart A [Amended]**

■ 94. Amend § 1037.1 by revising paragraph (a) to read as follows:

**§ 1037.1 Applicability.**

(a) The regulations in this part 1037 apply for all new heavy-duty vehicles, except as provided in §§ 1037.5 and 1037.104. This includes electric vehicles, fuel cell vehicles, and vehicles

fueled by conventional and alternative fuels. This also includes certain trailers as described in §§ 1037.5, 1037.150, and 1037.801.

\* \* \* \* \*

■ 95. Amend § 1037.5 by revising paragraph (e) to read as follows:

**§ 1037.5 Excluded vehicles.**

\* \* \* \* \*

(e) Vehicles subject to the heavy-duty emission standards of 40 CFR part 86. See 40 CFR 86.1816 and 86.1819 for emission standards that apply for these vehicles. This exclusion generally applies for complete heavy-duty

vehicles at or below 14,000 pounds GVWR.

\* \* \* \* \*

■ 96. Amend § 1037.10 by revising paragraph (c) to read as follows:

**§ 1037.10 How is this part organized?**

\* \* \* \* \*

(c) Subpart C of this part describes how to apply for a certificate of conformity.

\* \* \* \* \*

■ 97. Revise § 1037.101 to read as follows:

**§ 1037.101 Overview of emission standards.**

This part specifies emission standards for certain vehicles and for certain pollutants. This part contains standards and other regulations applicable to the emission of the air pollutant defined as the aggregate group of six greenhouse gases: carbon dioxide, nitrous oxide, methane, hydrofluorocarbons, perfluorocarbons, and sulfur hexafluoride.

(a) You must show that vehicles meet the following emission standards:

(1) *Exhaust emissions of criteria pollutants.* Criteria pollutant standards for NO<sub>x</sub>, HC, PM, and CO apply as described in § 1037.102. These pollutants are sometimes described collectively as “criteria pollutants” because they are either criteria pollutants under the Clean Air Act or precursors to the criteria pollutants ozone and PM.

(2) *Exhaust emissions of greenhouse gases.* These pollutants are described collectively in this part as “greenhouse gas pollutants” because they are regulated primarily based on their impact on the climate. Emission standards apply as follows for greenhouse gas (GHG) emissions:

(i) CO<sub>2</sub>, CH<sub>4</sub>, and N<sub>2</sub>O emission standards apply as described in §§ 1037.105 through 1037.107.

(ii) Hydrofluorocarbon standards apply as described in § 1037.115(e). These pollutants are also “greenhouse gas pollutants” but are treated separately from exhaust greenhouse gas pollutants listed in paragraph (b)(2)(i) of this section.

(3) *Fuel evaporative and refueling emissions.* Requirements related to fuel evaporative and refueling emissions are described in § 1037.103.

(b) The regulated heavy-duty vehicles are addressed in different groups as follows:

(1) For criteria pollutants, vocational vehicles and tractors are regulated based on gross vehicle weight rating (GVWR), whether they are considered “spark-ignition” or “compression-ignition,” and whether they are first sold as complete or incomplete vehicles.

(2) For greenhouse gas pollutants, vehicles are regulated in the following groups:

(i) Tractors above 26,000 pounds GVWR.

(ii) Trailers.

(iii) Vocational vehicles.

(3) The greenhouse gas emission standards apply differently depending on the vehicle service class as described in § 1037.140. In addition, standards apply differently for vehicles with spark-ignition and compression-ignition

engines. References in this part 1037 to “spark-ignition” or “compression-ignition” generally relate to the application of standards under 40 CFR 1036.140. For example, a vehicle with an engine certified to spark-ignition standards under 40 CFR part 1036 is generally subject to requirements under this part 1037 that apply for spark-ignition vehicles. However, note that emission standards for Heavy HDE are considered to be compression-ignition standards for purposes of applying vehicle emission standards under this part. Also, for spark-ignition engines voluntarily certified as compression-ignition engines under 40 CFR part 1036, you must choose at certification whether your vehicles are subject to spark-ignition standards or compression-ignition standards.

(4) For evaporative and refueling emissions, vehicles are regulated based on the type of fuel they use. Vehicles fueled with volatile liquid fuels or gaseous fuels are subject to evaporative and refueling emission standards.

■ 98. Revise § 1037.102 to read as follows:

**§ 1037.102 Exhaust emission standards for NO<sub>x</sub>, HC, PM, and CO.**

(a) Engines installed in heavy-duty vehicles are subject to criteria pollutant standards for NO<sub>x</sub>, HC, PM, and CO under 40 CFR part 86 through model year 2026 and 40 CFR part 1036 for model years 2027 and later.

(b) Heavy-duty vehicles with no installed propulsion engine, such as electric vehicles, are subject to criteria pollutant standards under this part. The emission standards that apply are the same as the standards that apply for compression-ignition engines under 40 CFR 86.007–11 and 1036.104 for a given model year.

(1) You may state in the application for certification that vehicles with no installed propulsion engine comply with all the requirements of this part related to criteria emission standards instead of submitting test data. Tailpipe emissions of criteria pollutants from vehicles with no installed propulsion engine are deemed to be zero.

(2) Vehicles with no installed propulsion engines may not generate NO<sub>x</sub> credits.

■ 99. Amend § 1037.103 by:

■ a. Revising paragraph (b)(1);

■ b. Removing paragraph (b)(6); and

■ c. Revising paragraphs (f) and (g)(1) and (2).

The revisions read as follows:

**§ 1037.103 Evaporative and refueling emission standards.**

\* \* \* \* \*

(b) \* \* \*

(1) The refueling standards in 40 CFR 86.1813–17(b) and the related provisions in 40 CFR part 86, subpart S, apply to complete vehicles starting in model year 2022. Those standards and related provisions apply for incomplete vehicles starting in model year 2027, or as described in the alternate phase-in schedule described in 40 CFR 86.1813–17(b). If you do not certify all your incomplete heavy-duty vehicles above 14,000 pounds GVWR to the refueling standards in model year 2027, you must use the alternate phase-in schedule described in 40 CFR 86.1813–17(b).

\* \* \* \* \*

(f) *Useful life.* The evaporative and refueling emission standards of this section apply for the full useful life, expressed in service miles or calendar years, whichever comes first. The useful life values for the standards of this section are the same as the values described for evaporative emission standards in 40 CFR 86.1805.

(g) \* \* \*

(1) Auxiliary engines and associated fuel-system components must be installed when testing fully assembled vehicles. If the auxiliary engine draws fuel from a separate fuel tank, you must fill the extra fuel tank before the start of diurnal testing as described for the vehicle’s main fuel tank. Use good engineering judgment to ensure that any nonmetal portions of the fuel system related to the auxiliary engine have reached stabilized levels of permeation emissions. The auxiliary engine must not operate during the running loss test or any other portion of testing under this section.

(2) For testing with partially assembled vehicles, you may omit installation of auxiliary engines and associated fuel-system components as long as those components installed in the final configuration are certified to meet the applicable emission standards for Small SI equipment described in 40 CFR 1054.112 or for Large SI engines in 40 CFR 1048.105. For any fuel-system components that you do not install, your installation instructions must describe this certification requirement.

■ 100. Amend § 1037.105 by:

■ a. Revising paragraph (g)(2);

■ b. Amending paragraph (h)(1) by revising footnote a in Table 5; and

■ c. Revising paragraphs (h)(5) through (7).

The revisions read as follows:

**§ 1037.105 CO<sub>2</sub> emission standards for vocational vehicles.**

\* \* \* \* \*

(g) \* \* \*

(2) Class 8 hybrid vehicles with Light HDE or Medium HDE may be certified to compression-ignition standards for the Heavy HDV service class. You may

generate and use credits as allowed for the Heavy HDV service class.

(h) \* \* \*  
(1) \* \* \*

TABLE 5 OF § 1037.105—PHASE 2 CUSTOM CHASSIS STANDARDS  
[g/ton-mile]

Vehicle type <sup>a</sup>	Assigned vehicle service class	MY 2021–2026	MY 2027+
*	*	*	*

<sup>a</sup> Vehicle types are generally defined in § 1037.801. “Other bus” includes any bus that is not a school bus or a coach bus. A “mixed-use vehicle” is one that meets at least one of the criteria specified in § 1037.631(a)(1) or (2).

(5) Emergency vehicles are deemed to comply with the standards of this paragraph (h) if they use tires with TRRL at or below 8.4 N/kN (8.7 N/kN for model years 2021 through 2026).

(6) Concrete mixers and mixed-use vehicles are deemed to comply with the standards of this paragraph (h) if they use tires with TRRL at or below 7.1 N/kN (7.6 N/kN for model years 2021 through 2026).

(7) Motor homes are deemed to comply with the standards of this paragraph (h) if they have tires with TRRL at or below 6.0 N/kN (6.7 N/kN for model years 2021 through 2026) and automatic tire inflation systems or tire pressure monitoring systems with wheels on all axles.

■ 101. Amend § 1037.106 by revising paragraph (f)(1) to read as follows:

**§ 1037.106 Exhaust emission standards for tractors above 26,000 pounds GVWR.**

(f) \* \* \*

(1) You may optionally certify 4x2 tractors with Heavy HDE to the standards and useful life for Class 8 tractors, with no restriction on generating or using emission credits within the Class 8 averaging set.

■ 102. Amend § 1037.115 by revising paragraphs (a) and (e)(3) to read as follows:

**§ 1037.115 Other requirements.**

(a) *Adjustable parameters.* Vehicles that have adjustable parameters must meet all the requirements of this part for any adjustment in the practically adjustable range. We may require that you set adjustable parameters to any specification within the practically adjustable range during any testing. See 40 CFR 1068.50 for general provisions related to adjustable parameters. You must ensure safe vehicle operation throughout the practically adjustable

range of each adjustable parameter, including consideration of production tolerances. Note that adjustable roof fairings and trailer rear fairings are deemed not to be adjustable parameters.

(3) If air conditioning systems are designed such that a compliance demonstration under 40 CFR 86.1867–12(a) is impossible or impractical, you may ask to use alternative means to demonstrate that your air conditioning system achieves an equivalent level of control.

■ 103. Amend § 1037.120 by revising paragraph (c) to read as follows:

**§ 1037.120 Emission-related warranty requirements.**

(c) *Components covered.* The emission-related warranty covers tires, automatic tire inflation systems, tire pressure monitoring systems, vehicle speed limiters, idle-reduction systems, hybrid system components, and devices added to the vehicle to improve aerodynamic performance (not including standard components such as hoods or mirrors even if they have been optimized for aerodynamics) to the extent such emission-related components are included in your application for certification. The emission-related warranty also covers other added emission-related components to the extent they are included in your application for certification. The emission-related warranty covers all components whose failure would increase a vehicle’s emissions of air conditioning refrigerants (for vehicles subject to air conditioning leakage standards), and it covers all components whose failure would increase a vehicle’s evaporative and refueling emissions (for vehicles subject to evaporative and refueling emission standards). The emission-related warranty covers components that are part of your certified configuration even if another company

produces the component. Your emission-related warranty does not need to cover components whose failure would not increase a vehicle’s emissions of any regulated pollutant.

■ 104. Amend § 1037.125 by revising paragraphs (a) and (d) to read as follows:

**§ 1037.125 Maintenance instructions and allowable maintenance.**

(a) *Critical emission-related maintenance.* Critical emission-related maintenance includes any adjustment, cleaning, repair, or replacement of critical emission-related components. Critical emission-related maintenance may also include additional emission-related maintenance that you determine is critical if we approve it in advance. You may schedule critical emission-related maintenance on these components if you demonstrate that the maintenance is reasonably likely to be done at the recommended intervals on in-use vehicles. We will accept scheduled maintenance as reasonably likely to occur if you satisfy any of the following conditions:

(d) *Noncritical emission-related maintenance.* Subject to the provisions of this paragraph (d), you may schedule any amount of emission-related inspection or maintenance that is not covered by paragraph (a) of this section (that is, maintenance that is neither explicitly identified as critical emission-related maintenance, nor that we approve as critical emission-related maintenance). Noncritical emission-related maintenance generally includes maintenance on the components we specify in 40 CFR part 1068, appendix A, that is not covered in paragraph (a) of this section. You must state in the owners manual that these steps are not necessary to keep the emission-related warranty valid. If operators fail to do this maintenance, this does not allow you to disqualify those vehicles from in-use testing or deny a warranty claim. Do

not take these inspection or maintenance steps during service accumulation on your emission-data vehicles.

\* \* \* \* \*

■ 105. Amend § 1037.130 by revising paragraph (b)(3) to read as follows:

§ 1037.130 Assembly instructions for secondary vehicle manufacturers.

\* \* \* \* \*

(b) \* \* \*

(3) Describe the necessary steps for installing emission-related diagnostic systems.

\* \* \* \* \*

■ 106. Amend § 1037.135 by revising paragraph (c)(6) to read as follows:

§ 1037.135 Labeling.

\* \* \* \* \*

(c) \* \* \*

(6) Identify the emission control system. Use terms and abbreviations as described in appendix C to this part or other applicable conventions. Phase 2 tractors and Phase 2 vocational vehicles may omit this information.

\* \* \* \* \*

■ 107. Amend § 1037.140 by revising paragraph (g) to read as follows:

§ 1037.140 Classifying vehicles and determining vehicle parameters.

\* \* \* \* \*

(g) The standards and other provisions of this part apply to specific vehicle service classes for tractors and vocational vehicles as follows:

(1) Phase 1 and Phase 2 tractors are divided based on GVWR into Class 7 tractors and Class 8 tractors. Where provisions of this part apply to both tractors and vocational vehicles, Class 7 tractors are considered "Medium HDV" and Class 8 tractors are considered "Heavy HDV". This paragraph (g)(1) applies for hybrid and non-hybrid vehicles.

(2) Phase 1 vocational vehicles are divided based on GVWR. "Light HDV" includes Class 2b through Class 5 vehicles; "Medium HDV" includes Class 6 and Class 7 vehicles; and "Heavy HDV" includes Class 8 vehicles.

(3) Phase 2 vocational vehicles propelled by engines subject to the spark-ignition standards of 40 CFR part 1036 are divided as follows:

(i) Class 2b through Class 5 vehicles are considered "Light HDV".

(ii) Class 6 through Class 8 vehicles are considered "Medium HDV".

(4) Phase 2 vocational vehicles propelled by engines subject to the compression-ignition standards in 40 CFR part 1036 are divided as follows:

(i) Class 2b through Class 5 vehicles are considered "Light HDV".

(ii) Class 6 through 8 vehicles are considered "Heavy HDV" if the installed engine's primary intended service class is Heavy HDE (see 40 CFR 1036.140), except that Class 8 hybrid vehicles are considered "Heavy HDV" regardless of the engine's primary intended service class.

(iii) All other Class 6 through Class 8 vehicles are considered "Medium HDV".

(5) Heavy-duty vehicles with no installed propulsion engine, such as electric vehicles, are divided as follows:

(i) Class 2b through Class 5 vehicles are considered "Light HDV".

(ii) Class 6 and 7 vehicles are considered "Medium HDV".

(iii) Class 8 vehicles are considered "Heavy HDV".

(6) In certain circumstances, you may certify vehicles to standards that apply for a different vehicle service class. For example, see §§ 1037.105(g) and 1037.106(f). If you optionally certify vehicles to different standards, those vehicles are subject to all the regulatory requirements as if the standards were mandatory.

\* \* \* \* \*

■ 108. Amend § 1037.150 by revising paragraphs (f) and (y)(1) to read as follows:

§ 1037.150 Interim provisions.

\* \* \* \* \*

(f) Electric and hydrogen fuel cell vehicles. Tailpipe emissions of regulated GHG pollutants from electric vehicles and hydrogen fuel cell vehicles are deemed to be zero. No CO2-related emission testing is required for electric vehicles or hydrogen fuel cell vehicles. Use good engineering judgment to apply other requirements of this part to electric vehicles.

\* \* \* \* \*

(y) \* \* \*

(1) For vocational Light HDV and vocational Medium HDV, emission credits you generate in model years 2018 through 2021 may be used through model year 2027, instead of being limited to a five-year credit life as specified in § 1037.740(c). For Class 8 vocational vehicles with Medium HDE, we will approve your request to generate these credits in and use these credits for the Medium HDV averaging set if you show that these vehicles would qualify as Medium HDV under the Phase 2 program as described in § 1037.140(g)(4).

\* \* \* \* \*

■ 109. Amend § 1037.201 by revising paragraph (h) to read as follows:

§ 1037.201 General requirements for obtaining a certificate of conformity.

\* \* \* \* \*

(h) The certification and testing provisions of 40 CFR part 86, subpart S, apply instead of the provisions of this subpart relative to the evaporative and refueling emission standards specified in § 1037.103, except that § 1037.243 describes how to demonstrate compliance with evaporative and refueling emission standards. For vehicles that do not use an evaporative canister for controlling diurnal emissions, you may certify with respect to exhaust emissions and use the provisions of § 1037.622 to let a different company certify with respect to evaporative emissions.

\* \* \* \* \*

■ 110. Amend § 1037.205 by revising paragraphs (e) and (p), and adding paragraph (q) to read as follows:

§ 1037.205 What must I include in my application?

\* \* \* \* \*

(e) Describe any test equipment and procedures that you used, including any special or alternate test procedures you used (see § 1037.501). Include information describing the procedures you used to determine C<sub>dA</sub> values as specified in §§ 1037.525 through 1037.527. Describe which type of data you are using for engine fuel maps (see 40 CFR 1036.505). If your trailer certification relies on approved data from device manufacturers, identify the device and device manufacturer.

\* \* \* \* \*

(p) Where applicable, describe all adjustable operating parameters (see § 1037.115), including production tolerances. For any operating parameters that do not qualify as adjustable parameters, include a description supporting your conclusion (see 40 CFR 1068.50(c)). Include the following in your description of each adjustable parameter:

(1) The nominal or recommended setting.

(2) The intended practically adjustable range.

(3) The limits or stops used to establish adjustable ranges.

(4) Information showing why the limits, stops, or other means of inhibiting adjustment are effective in preventing adjustment of parameters on in-use engines to settings outside your intended practically adjustable ranges.

(q) Include the following information for electric vehicles and fuel cell vehicles to show they meet the standards of this part:

(1) You may attest that vehicles comply with the standards of § 1037.102 instead of submitting test data.

(2) For vehicles generating credits under § 1037.616, you may attest that the vehicle meets the durability requirements described in § 1037.102(b)(3) based on an engineering analysis of measured values and other information, consistent with good engineering judgment, instead of testing at the end of the useful life. Send us your test results for work produced over the FTP and initial useable battery energy or initial fuel cell voltage. Also send us your engineering analysis describing how you meet the durability requirements if we ask for it.

\* \* \* \* \*

■ 111. Amend § 1037.225 by revising the introductory text and paragraph (g) to read as follows:

**§ 1037.225 Amending applications for certification.**

Before we issue you a certificate of conformity, you may amend your application to include new or modified vehicle configurations, subject to the provisions of this section. After we have issued your certificate of conformity, you may send us an amended application any time before the end of the model year requesting that we include new or modified vehicle configurations within the scope of the certificate, subject to the provisions of this section. You must amend your application if any changes occur with respect to any information that is included or should be included in your application.

\* \* \* \* \*

(g) You may produce vehicles or modify in-use vehicles as described in your amended application for certification and consider those vehicles to be in a certified configuration. Modifying a new or in-use vehicle to be in a certified configuration does not violate the tampering prohibition of 40 CFR 1068.101(b)(1), as long as this does not involve changing to a certified configuration with a higher family emission limit. See § 1037.621(g) for special provisions that apply for

changing to a different certified configuration in certain circumstances.

■ 112. Amend § 1037.230 by revising paragraph (c) to read as follows:

**§ 1037.230 Vehicle families, sub-families, and configurations.**

\* \* \* \* \*

(c) Group vehicles into configurations consistent with the definition of “vehicle configuration” in § 1037.801. Note that vehicles with hardware or software differences that are related to measured or modeled emissions are considered to be different vehicle configurations even if they have the same modeling inputs and FEL. Note also, that you are not required to separately identify all configurations for certification. Note that you are not required to identify all possible configurations for certification; also, you are required to include in your final ABT report only those configurations you produced.

\* \* \* \* \*

■ 113. Amend § 1037.231 by revising paragraph (b)(1) to read as follows:

**§ 1037.231 Powertrain families.**

\* \* \* \* \*

(b) \* \* \*

(1) Engine family as specified in 40 CFR 1036.230.

\* \* \* \* \*

■ 114. Amend § 1037.243 by revising the section heading and paragraphs (a) and (b) to read as follows:

**§ 1037.243 Demonstrating compliance with evaporative and refueling emission standards.**

(a) For purposes of certification, your vehicle family is considered in compliance with the evaporative and refueling emission standards in subpart B of this part if you prepare an engineering analysis showing that your vehicles in the family will comply with applicable standards throughout the useful life, and there are no test results from an emission-data vehicle representing the family that exceed an emission standard.

(b) Your evaporative refueling emission family is deemed not to comply if your engineering analysis is not adequate to show that all the

vehicles in the family will comply with applicable emission standards throughout the useful life, or if a test result from an emission-data vehicle representing the family exceeds an emission standard.

\* \* \* \* \*

■ 115. Amend § 1037.250 by revising paragraph (a) to read as follows:

**§ 1037.250 Reporting and recordkeeping.**

(a) By September 30 following the end of the model year, send the Designated Compliance Officer a report including the total U.S.-directed production volume of vehicles you produced in each vehicle family during the model year (based on information available at the time of the report). Report by vehicle identification number and vehicle configuration and identify the subfamily identifier. Report uncertified vehicles sold to secondary vehicle manufacturers. We may waive the reporting requirements of this paragraph (a) for small manufacturers.

\* \* \* \* \*

■ 116. Amend § 1037.320 by revising paragraph (b) to read as follows and removing Table 1 to § 1037.320:

**§ 1037.320 Audit procedures for axles and transmissions.**

\* \* \* \* \*

(b) Run GEM with the define vehicles to determine whether the transmission or axle family passes the audit.

(1) For transmission audits, run GEM for each applicable vehicle configuration and GEM regulatory subcategory identified in 40 CFR 1036.540 and for each vehicle class as defined in § 1037.140(g) using the applicable default engine map in appendix C of 40 CFR part 1036, the cycle-average fuel map in Table 1 of this section, the torque curve in Table 2 of this section for both the engine full-load torque curve and parent engine full-load torque curve, the motoring torque curve in Table 3 of this section, the idle fuel map in Table 4 of this section. For transmission testing, use the test transmission’s gear ratios in place of the gear ratios defined in 40 CFR 1036.540. Table 1 through Table 4 follow:

TABLE 1 TO PARAGRAPH (b)(1) OF § 1037.320—TRANSIENT CYCLE-AVERAGE FUEL MAP BY VEHICLE CLASS

Light HDV and medium HDV—spark-ignition					Light HDV and medium HDV—compression-ignition					Heavy HDV				
Engine cycle work (kW-hr)	N/V (r/min)	Fuel mass (g)	Idle speed (r/min)	Idle torque (N·m)	Engine cycle work (kW-hr)	N/V (r/min)	Fuel mass (g)	Idle speed (r/min)	Idle torque (N·m)	Engine cycle work (kW-hr)	N/V (r/min)	Fuel mass (g)	Idle speed (r/min)	Idle torque (N·m)
3.5404	2.8739	1109.31	600.5	37.997	3.3057	2.3317	919.01	750.3	36.347	11.4255	2.3972	2579.58	600.7	89.658
3.6574	3.0198	1153.35	600.4	37.951	3.3822	2.5075	982.53	750.2	36.461	11.6112	2.2432	2591.08	601.2	90.428
3.8119	3.0370	1188.66	600.2	37.956	3.4917	2.5320	998.64	750.2	36.608	12.5052	2.1620	2763.28	602.4	92.014
4.0121	3.1983	1250.76	600.1	38.153	3.6087	2.6181	1036.34	750.2	36.734	17.7747	2.5195	3835.77	602.2	91.780



TABLE 1 TO PARAGRAPH (b)(1) OF § 1037.320—TRANSIENT CYCLE-AVERAGE FUEL MAP BY VEHICLE CLASS—Continued

Light HDV and medium HDV—spark-ignition					Light HDV and medium HDV—compression-ignition					Heavy HDV				
Engine cycle work (kW-hr)	N/V (r/min)	Fuel mass (g)	Idle speed (r/min)	Idle torque (N-m)	Engine cycle work (kW-hr)	N/V (r/min)	Fuel mass (g)	Idle speed (r/min)	Idle torque (N-m)	Engine cycle work (kW-hr)	N/V (r/min)	Fuel mass (g)	Idle speed (r/min)	Idle torque (N-m)
5.5567	3.1325	1585.32	604.6	56.535	5.2397	2.5050	1354.33	753.0	51.992	18.4901	2.4155	3994.29	603.5	93.724
5.6814	3.2956	1639.08	604.0	56.549	5.3153	2.7289	1417.20	751.9	51.488	20.1904	2.3800	4374.06	605.1	96.340
5.8720	3.3255	1686.14	602.5	56.234	5.4112	2.6689	1416.75	751.3	51.280	.....	.....	.....	.....	.....
6.1774	3.4848	1773.39	601.7	56.038	5.5590	2.7231	1450.67	751.0	51.254	.....	.....	.....	.....	.....

TABLE 2 TO PARAGRAPH (b)(1) OF § 1037.320—FULL-LOAD TORQUE CURVES BY VEHICLE CLASS

Light HDV and medium HDV—spark-ignition		Light HDV and medium HDV—compression-ignition		Heavy HDV	
Engine speed (r/min)	Engine torque (N-m)	Engine speed (r/min)	Engine torque (N-m)	Engine speed (r/min)	Engine torque (N-m)
600	433	750	470	600	1200
700	436	907	579	750	1320
800	445	1055	721	850	1490
900	473	1208	850	950	1700
1000	492	1358	876	1050	1950
1100	515	1507	866	1100	2090
1200	526	1660	870	1200	2100
1300	541	1809	868	1250	2100
1400	542	1954	869	1300	2093
1500	542	2105	878	1400	2092
1600	542	2258	850	1500	2085
1700	547	2405	800	1520	2075
1800	550	2556	734	1600	2010
1900	551	2600	0	1700	1910
2000	554	.....	.....	1800	1801
2100	553	.....	.....	1900	1640
2200	558	.....	.....	2000	1350
2300	558	.....	.....	2100	910
2400	566	.....	.....	2250	0
2500	571				
2600	572				
2700	581				
2800	586				
2900	587				
3000	590				
3100	591				
3200	589				
3300	585				
3400	584				
3500	582				
3600	573				
3700	562				
3800	555				
3900	544				
4000	534				
4100	517				
4200	473				
4291	442				
4500	150				

TABLE 3 TO PARAGRAPH (b)(1) OF § 1037.320—MOTORING TORQUE CURVES BY VEHICLE CLASS

Light HDV and medium HDV—spark-ignition		Light HDV and medium HDV—compression-ignition		Heavy HDV	
Engine speed (r/min)	Engine torque (N-m)	Engine speed (r/min)	Engine torque (N-m)	Engine speed (r/min)	Engine torque (N-m)
700	-41	750	-129	600	-98
800	-42	907	-129	750	-121
900	-43	1055	-130	850	-138
1000	-45	1208	-132	950	-155
1100	-48	1358	-135	1050	-174
1200	-49	1507	-138	1100	-184
1300	-50	1660	-143	1200	-204

TABLE 3 TO PARAGRAPH (b)(1) OF § 1037.320—MOTORING TORQUE CURVES BY VEHICLE CLASS—Continued

Light HDV and medium HDV—spark-ignition		Light HDV and medium HDV—compression-ignition		Heavy HDV	
Engine speed (r/min)	Engine torque (N·m)	Engine speed (r/min)	Engine torque (N·m)	Engine speed (r/min)	Engine torque (N·m)
1411	−51	1809	−148	1250	−214
1511	−52	1954	−155	1300	−225
1611	−53	2105	−162	1400	−247
1711	−56	2258	−170	1500	−270
1811	−56	2405	−179	1520	−275
1911	−57	2556	−189	1600	−294
2011	−57	.....	.....	1700	−319
2111	−58	.....	.....	1800	−345
2211	−60	.....	.....	1900	−372
2311	−65	.....	.....	2000	−400
2411	−81	.....	.....	2100	−429
2511	−85				
2611	−87				
2711	−88				
2811	−89				
2911	−91				
3011	−91				
3111	−96				
3211	−96				
3311	−97				
3411	−98				
3511	−99				
3611	−104				
3711	−105				
3811	−108				
3911	−108				
4011	−111				
4111	−111				
4211	−115				
4291	−112				

TABLE 4 TO PARAGRAPH (b)(1) OF § 1037.320—ENGINE IDLE FUEL MAPS BY VEHICLE CLASS

Light HDV and medium HDV—spark-ignition			Light HDV and medium HDV—compression-ignition			Heavy HDV		
Engine speed (r/min)	Engine torque (N·m)	Fuel mass rate (g/s)	Engine speed (r/min)	Engine torque (N·m)	Fuel mass rate (g/s)	Engine speed (r/min)	Engine torque (N·m)	Fuel mass rate (g/s)
600	0	0.4010	750	0	0.2595	600	0	0.3501
700	0	0.4725	850	0	0.2626	700	0	0.4745
600	100	0.6637	750	100	0.6931	600	100	0.6547
700	100	0.7524	850	100	0.7306	700	100	0.8304

(2) Follow the procedure in paragraph (b)(1) of this section for axle audits, but cover the range of tire sizes by using good engineering judgment to select three representative tire sizes for each axle ratio for each vehicle configuration instead of using the tire size determined in 40 CFR 1036.540.

(3) The GEM “Default FEL CO<sub>2</sub> Emissions” result for each vehicle configuration counts as a separate test for determining whether the family passes the audit. For vocational vehicles, use the GEM “Default FEL CO<sub>2</sub> Emissions” result for the Regional subcategory.

\* \* \* \* \*

■ 117. Amend § 1037.510 by revising paragraphs (a)(1)(i), (2), and (3) and (d) to read as follows:

**§ 1037.510 Duty-cycle exhaust testing.**

\* \* \* \* \*

(a) \* \* \*

(1) \* \* \*

(i) *Transient cycle.* The transient cycle is specified in appendix A of this part. Warm up the vehicle. Start the duty cycle within 30 seconds after concluding the preconditioning procedure. Start sampling emissions at the start of the duty cycle.

\* \* \* \* \*

(2) Perform cycle-average engine fuel mapping as described in 40 CFR 1036.540. For powertrain testing under § 1037.550 or § 1037.555, perform testing as described in this paragraph (a)(2) to generate GEM inputs for each simulated vehicle configuration, and

test runs representing different idle conditions. Perform testing as follows:

(i) *Transient cycle.* The transient cycle is specified in appendix A of this part.

(ii) *Highway cruise cycles.* The grade portion of the route corresponding to the 55 mi/hr and 65 mi/hr highway cruise cycles is specified in appendix D of this part. Maintain vehicle speed between −1.0 mi/hr and 3.0 mi/hr of the speed setpoint; this speed tolerance applies instead of the approach specified in 40 CFR 1066.425(b)(1) and (2).

(iii) *Drive idle.* Perform testing at a loaded idle condition for Phase 2 vocational vehicles. For engines with an adjustable warm idle speed setpoint, test at the minimum warm idle speed and the maximum warm idle speed;

otherwise simply test at the engine's warm idle speed. Warm up the powertrain as described in 40 CFR 1036.520(c)(1). Within 60 seconds after concluding the warm-up, linearly ramp the powertrain down to zero vehicle speed over 20 seconds. Apply the brake and keep the transmission in drive (or clutch depressed for manual transmission). Stabilize the powertrain for (60 ±1) seconds and then sample emissions for (30 ±1) seconds.

(iv) *Parked idle*. Perform testing at a no-load idle condition for Phase 2 vocational vehicles. For engines with an adjustable warm idle speed setpoint, test at the minimum warm idle speed and the maximum warm idle speed; otherwise simply test at the engine's warm idle speed. Warm up the powertrain as described in 40 CFR 1036.520(c)(1). Within 60 seconds after concluding the warm-up, linearly ramp the powertrain down to zero vehicle speed in 20 seconds. Put the transmission in park (or neutral for manual transmissions and apply the parking brake if applicable). Stabilize the powertrain for (180 ±1) seconds and then sample emissions for (600 ±1) seconds.

(3) Where applicable, perform testing on a chassis dynamometer as follows:

(i) *Transient cycle*. The transient cycle is specified in appendix A of this part. Warm up the vehicle by operating over one transient cycle. Within 60 seconds after concluding the warm up cycle, start emission sampling and operate the vehicle over the duty cycle.

(ii) *Highway cruise cycle*. The grade portion of the route corresponding to the 55 mi/hr and 65 mi/hr highway

cruise cycles is specified in appendix D of this part. Warm up the vehicle by operating it at the appropriate speed setpoint over the duty cycle. Within 60 seconds after concluding the preconditioning cycle, start emission sampling and operate the vehicle over the duty cycle, maintaining vehicle speed within ±1.0 mi/hr of the speed setpoint; this speed tolerance applies instead of the approach specified in 40 CFR 1066.425(b)(1) and (2).

(d) For highway cruise and transient testing, compare actual second-by-second vehicle speed with the speed specified in the test cycle and ensure any differences are consistent with the criteria as specified in § 1037.550(g)(1). If the speeds do not conform to these criteria, the test is not valid and must be repeated.

■ 118. Amend § 1037.520 by revising paragraphs (c)(2) and (3), (f), and (h)(1) to read as follows:

**§ 1037.520 Modeling CO<sub>2</sub> emissions to show compliance for vocational vehicles and tractors.**

(c) \* \* \*

(2) Measure tire rolling resistance in newton per kilonewton as specified in ISO 28580 (incorporated by reference in § 1037.810), except as specified in this paragraph (c). Use good engineering judgment to ensure that your test results are not biased low. You may ask us to identify a reference test laboratory to which you may correlate your test results. Prior to beginning the test

procedure in Section 7 of ISO 28580 for a new bias-ply tire, perform a break-in procedure by running the tire at the specified test speed, load, and pressure for (60 ±2) minutes.

(3) For each tire design tested, measure rolling resistance of at least three different tires of that specific design and size. Perform the test at least once for each tire. Calculate the arithmetic mean of these results to the nearest 0.1 N/kN and use this value or any higher value as your GEM input for TRRL. You must test at least one tire size for each tire model, and may use engineering analysis to determine the rolling resistance of other tire sizes of that model. Note that for tire sizes that you do not test, we will treat your analytically derived rolling resistances the same as test results, and we may perform our own testing to verify your values. We may require you to test a small sub-sample of untested tire sizes that we select.

(f) *Engine characteristics*. Enter information from the engine manufacturer to describe the installed engine and its operating parameters as described in 40 CFR 1036.505. Note that you do not need fuel consumption at idle for tractors.

(h) \* \* \*

(1) For engines with no adjustable warm idle speed, input vehicle idle speed as the manufacturer's declared warm idle speed. For engines with adjustable warm idle speed, input your vehicle idle speed as follows:

If your vehicle is a	And your engine is subject to	Your default vehicle idle speed is <sup>a</sup>
(i) Heavy HDV .....	compression-ignition or spark-ignition standards .....	600 r/min.
(ii) Medium HDV tractor .....	compression-ignition standards .....	700 r/min.
(iii) Light HDV or Medium HDV vocational vehicle .....	compression-ignition standards .....	750 r/min.
(iv) Light HDV or Medium HDV .....	spark-ignition standards .....	600 r/min.

<sup>a</sup> If the default idle speed is above or below the engine manufacturer's whole range of declared warm idle speeds, use the manufacturer's maximum or minimum declared warm idle speed, respectively, instead of the default value.

■ 119. Amend § 1037.534 by revising paragraph (d)(2) to read as follows:

**§ 1037.534 Constant-speed procedure for calculating drag area (C<sub>d</sub>A).**

(d) \* \* \*

(2) Perform testing as described in paragraph (d)(3) of this section over a sequence of test segments at constant vehicle speed as follows:

(i) (300 ±30) seconds in each direction at 10 mi/hr.

(ii) (450 ±30) seconds in each direction at 70 mi/hr.

(iii) (450 ±30) seconds in each direction at 50 mi/hr.

(iv) (450 ±30) seconds in each direction at 70 mi/hr.

(v) (450 ±30) seconds in each direction at 50 mi/hr.

(vi) (300 ±30) seconds in each direction at 10 mi/hr.

■ 120. Amend § 1037.540 by revising the introductory text and paragraphs (b)(3), (7), (8), and (f) to read as follows:

**§ 1037.540 Special procedures for testing vehicles with hybrid power take-off.**

This section describes optional procedures for quantifying the reduction in greenhouse gas emissions for vehicles as a result of running power take-off (PTO) devices with a hybrid energy delivery system. See § 1037.550 for powertrain testing requirements that apply for drivetrain hybrid systems. The procedures are written to test the PTO by ensuring that the engine produces all of the energy with no net change in stored energy (charge-sustaining), and

for plug-in hybrid vehicles, also allowing for drawing down the stored energy (charge-depleting). The full charge-sustaining test for the hybrid vehicle is from a fully charged rechargeable energy storage system (RESS) to a depleted RESS and then back to a fully charged RESS. You must include all hardware for the PTO system. You may ask us to modify the provisions of this section to allow testing hybrid vehicles other than battery electric hybrids, consistent with good engineering judgment. For plug-in hybrids, use a utility factor to properly weight charge-sustaining and charge-depleting operation as described in paragraph (f)(3) of this section.

(b) \* \* \*  
 (3) Denormalize the PTO duty cycle in appendix B of this part using the following equation:

$$p_{refi} = p_i \cdot (\bar{p}_{max} - \bar{p}_{min}) + \bar{p}_{min}$$

Eq. 1037.540-1

Where:

$p_{refi}$  = the reference pressure at each point  $i$  in the PTO cycle.

$p_i$  = the normalized pressure at each point  $i$  in the PTO cycle (relative to  $\bar{p}_{max}$ ).

$\bar{p}_{max}$  = the mean maximum pressure measured in paragraph (b)(2) of this section.

$$m_{fuelPTOplug-in} = \sum_{i=1}^N [m_{fuelPTOCDi} \cdot (UF_{DCDi} - UF_{DCDi-1})] + \sum_{j=1}^M [m_{fuelPTOCSj}] \cdot \frac{(1 - UF_{RCD})}{M}$$

Eq. 1037.540-3

Where:

$i$  = an indexing variable that represents one test interval.

$N$  = total number of charge-depleting test intervals.

$m_{fuelPTOCD}$  = total mass of fuel per ton-mile in the charge-depleting portion of the test for each test interval,  $i$ , starting from  $i = 1$ .

$UF_{DCDi}$  = utility factor fraction at time  $t_{CDi}$  as determined in paragraph (f)(3)(i) of this section for each test interval,  $i$ , starting from  $i = 1$ .

$j$  = an indexing variable that represents one test interval.

$M$  = total number of charge-sustaining test intervals.

$m_{fuelPTOCS}$  = total mass of fuel per ton-mile in the charge-sustaining portion of the test for each test interval,  $j$ , starting from  $j = 1$ .

$UF_{RCD}$  = utility factor fraction at the full charge-depleting time,  $t_{CD}$ , as determined by interpolating the approved utility factor curve.  $t_{CD}$  is the sum of the time over  $N$  charge-depleting test intervals.

(4) Calculate the difference between the conventional PTO emissions result

$\bar{p}_{min}$  = the mean minimum pressure measured in paragraph (b)(2) of this section.

\* \* \* \* \*

(7) Depending on the number of circuits the PTO system has, operate the vehicle over one or concurrently over both of the denormalized PTO duty cycles in appendix B of this part. Measure emissions during operation over each duty cycle using the provisions of 40 CFR part 1066.

(8) Measured pressures must meet the cycle-validation specifications in the following table for each test run over the duty cycle:

TABLE 1 TO PARAGRAPH (b)(8) OF § 1037.540—STATISTICAL CRITERIA FOR VALIDATING EACH TEST RUN OVER THE DUTY CYCLE

Parameter <sup>a</sup>	Pressure
Slope, $a_1$ .....	$0.950 \leq a_1 \leq 1.030$ .
Absolute value of intercept, $ a_0 $ .	$\leq 2.0\%$ of maximum mapped pressure.
Standard error of the estimate, $SEE$ .	$\leq 10\%$ of maximum mapped pressure.
Coefficient of determination, $r^2$ .	$\geq 0.970$ .

<sup>a</sup> Determine values for specified parameters as described in 40 CFR 1065.514(e) by comparing measured values to denormalized pressure values from the duty cycle in appendix B of this part.

\* \* \* \* \*

(f) For Phase 2, calculate the delta PTO fuel results for input into GEM during vehicle certification as follows:

(1) Determine fuel consumption by calculating the mass of fuel for each test in grams,  $m_{fuelPTO}$ , without rounding, as described in 40 CFR 1036.540(d)(12) for both the conventional vehicle and the charge-sustaining and charge-depleting portions of the test for the hybrid vehicle as applicable.

(2) Divide the fuel mass by the applicable distance determined in paragraph (d)(4) of this section and the appropriate standard payload as defined in § 1037.801 to determine the fuel-consumption rate in g/ton-mile.

(3) For plug-in hybrid electric vehicles calculate the utility factor weighted fuel-consumption rate in g/ton-mile, as follows:

(i) Determine the utility factor fraction for the PTO system from the table in appendix E of this part using interpolation based on the total time of the charge-depleting portion of the test as determined in paragraphs (c)(6) and (d)(3) of this section.

(ii) Weight the emissions from the charge-sustaining and charge-depleting portions of the test to determine the utility factor-weighted fuel mass,  $m_{fuelUF[cycle]plug-in}$ , using the following equation:

and the hybrid PTO emissions result for input into GEM.

\* \* \* \* \*

■ 121. Revise § 1037.550 to read as follows:

**§ 1037.550 Powertrain testing.**

This section describes the procedure to measure fuel consumption and create engine fuel maps by testing a powertrain that includes an engine coupled with a transmission, drive axle, and hybrid components or any assembly with one or more of those hardware elements. Engine fuel maps are part of demonstrating compliance with Phase 2 vehicle standards under this part; the powertrain test procedure in this section is one option for generating this fuel-mapping information as described in 40 CFR 1036.505. Additionally, this powertrain test procedure is one option for certifying hybrids to the engine standards in 40 CFR 1036.108.

(a) *General test provisions.* The following provisions apply broadly for testing under this section:

(1) Measure NO<sub>x</sub> emissions as described in paragraph (k) of this section. Include these measured NO<sub>x</sub> values any time you report to us your greenhouse gas emissions or fuel consumption values from testing under this section.

(2) The procedures of 40 CFR part 1065 apply for testing in this section except as specified. This section uses engine parameters and variables that are consistent with 40 CFR part 1065.

(3) Powertrain testing depends on models to calculate certain parameters. You can use the detailed equations in this section to create your own models, or use the GEM HIL model contained within GEM Phase 2, Version 4.0 (incorporated by reference in § 1037.810) to simulate vehicle hardware elements as follows:

(i) Create driveline and vehicle models that calculate the angular speed

setpoint for the test cell dynamometer,  $f_{\text{ref,dyno}}$ , based on the torque measurement location. Use the detailed equations in paragraph (f) of this section, the GEM HIL model's driveline and vehicle submodels, or a combination of the equations and the submodels. You may use the GEM HIL model's transmission submodel in paragraph (f) of this section to simulate a transmission only if testing hybrid engines.

(ii) Create a driver model or use the GEM HIL model's driver submodel to simulate a human driver modulating the throttle and brake pedals to follow the test cycle as closely as possible.

(iii) Create a cycle-interpolation model or use the GEM HIL model's cycle submodel to interpolate the duty-cycles and feed the driver model the duty-cycle reference vehicle speed for each point in the duty-cycle.

(4) The powertrain test procedure in this section is designed to simulate operation of different vehicle configurations over specific duty cycles. See paragraphs (h) and (j) of this section.

(5) For each test run, record engine speed and torque as defined in 40 CFR 1065.915(d)(5) with a minimum sampling frequency of 1 Hz. These engine speed and torque values represent a duty cycle that can be used for separate testing with an engine mounted on an engine dynamometer under § 1037.551, such as for a selective enforcement audit as described in § 1037.301.

(6) For hybrid powertrains with no plug-in capability, correct for the net energy change of the energy storage device as described in 40 CFR 1066.501. For plug-in hybrid electric powertrains, follow 40 CFR 1066.501 to determine End-of-Test for charge-depleting operation. You must get our approval in advance for your utility factor curve; we will approve it if you can show that you created it, using good engineering judgment, from sufficient in-use data of vehicles in the same application as the vehicles in which the plug-in hybrid electric powertrain will be installed. You may use methodologies described in SAE J2841 (incorporated by reference in § 1037.810) to develop the utility factor curve.

(7) The provisions related to carbon balance error verification in 40 CFR 1036.543 apply for all testing in this section. These procedures are optional if you are only performing direct or indirect fuel-flow measurement, but we will perform carbon balance error verification for all testing under this section.

(8) Do not apply accessory loads when conducting a powertrain test to generate inputs to GEM if torque is measured at the axle input shaft or wheel hubs.

(9) If you test a powertrain over the duty cycle specified in 40 CFR 1036.514, control and apply the electrical accessory loads using one of the following systems:

(i) An alternator with dynamic electrical load control.

(ii) A load bank connected directly to the powertrain's electrical system.

(b) *Test configuration.* Select a powertrain for testing as described in § 1037.235 or 40 CFR 1036.235 as applicable. Set up the engine according to 40 CFR 1065.110 and 40 CFR 1065.405(b). Set the engine's idle speed to idle speed defined in § 1037.520(h)(1).

(1) The default test configuration consists of a powertrain with all components upstream of the axle. This involves connecting the powertrain's output shaft directly to the dynamometer or to a gear box with a fixed gear ratio and measuring torque at the axle input shaft. You may instead set up the dynamometer to connect at the wheel hubs and measure torque at that location. The preceding sentence may apply if your powertrain configuration requires it, such as for hybrid powertrains or if you want to represent the axle performance with powertrain test results.

(2) For testing hybrid engines, connect the engine's crankshaft directly to the dynamometer and measure torque at that location.

(c) *Powertrain temperatures during testing.* Cool the powertrain during testing so temperatures for oil, coolant, block, head, transmission, battery, and power electronics are within the manufacturer's expected ranges for normal operation. You may use electronic control module outputs to comply with this paragraph (c). You may use auxiliary coolers and fans.

(d) *Engine break in.* Break in the engine according to 40 CFR 1065.405, the axle assembly according to § 1037.560, and the transmission according to § 1037.565. You may instead break in the powertrain as a complete system using the engine break in procedure in 40 CFR 1065.405.

(e) *Dynamometer setup.* Set the dynamometer to operate in speed-control mode (or torque-control mode for hybrid engine testing at idle, including idle portions of transient duty cycles). Record data as described in 40 CFR 1065.202. Command and control the dynamometer speed at a minimum of 5 Hz, or 10 Hz for testing engine hybrids. Run the vehicle model to

calculate the dynamometer setpoints at a rate of at least 100 Hz. If the dynamometer's command frequency is less than the vehicle model dynamometer setpoint frequency, subsample the calculated setpoints for commanding the dynamometer setpoints.

(f) *Driveline and vehicle model.* Use the GEM HIL model's driveline and vehicle submodels or the equations in this paragraph (f) to calculate the dynamometer speed setpoint,  $f_{\text{ref,dyno}}$ , based on the torque measurement location. For all powertrains, configure GEM with the accessory load set to zero. For hybrid engines, configure GEM with the applicable accessory load as specified in 40 CFR 1036.505 and 1036.514. For all powertrains and hybrid engines, configure GEM with the tire slip model disabled.

(1) *Driveline model with a transmission in hardware.* For testing with torque measurement at the axle input shaft or wheel hubs, calculate,  $f_{\text{ref,dyno}}$ , using the GEM HIL model's driveline submodel or the following equation:

$$f_{\text{nrefi,dyno}} = \frac{k_{a[\text{speed}]} \cdot v_{\text{refi}}}{2 \cdot \pi \cdot r_{[\text{speed}]}}$$

Eq. 1037.550-1

Where:

$k_{a[\text{speed}]}$  = drive axle ratio as determined in paragraph (h) of this section. Set  $k_{a[\text{speed}]}$  equal to 1.0 if torque is measured at the wheel hubs.

$v_{\text{refi}}$  = simulated vehicle reference speed as calculated in paragraph (f)(3) of this section.

$r_{[\text{speed}]}$  = tire radius as determined in paragraph (h) of this section.

(2) *Driveline model with a simulated transmission.* For testing with the torque measurement at the engine's crankshaft,  $f_{\text{ref,dyno}}$  is the dynamometer target speed from the GEM HIL model's transmission submodel. You may request our approval to change the transmission submodel, as long as the changes do not affect the gear selection logic. Before testing, initialize the transmission model with the engine's measured torque curve and the applicable steady-state fuel map from the GEM HIL model. You may request our approval to input your own steady-state fuel map. For example, this request for approval could include using a fuel map that represents the combined performance of the engine and hybrid components. Configure the torque converter to simulate neutral idle when using this procedure to generate engine fuel maps in 40 CFR 1036.505 or to perform the Supplemental Emission Test (SET) testing under 40 CFR

1036.510. You may change engine commanded torque at idle to better represent CITT for transient testing under 40 CFR 1036.512. You may change the simulated engine inertia to match the inertia of the engine under test. We will evaluate your requests under this paragraph (f)(2) based on your demonstration that that the adjusted testing better represents in-use operation.

(i) The transmission submodel needs the following model inputs:

(A) Torque measured at the engine's crankshaft.

(B) Engine estimated torque determined from the electronic control

module or by converting the instantaneous operator demand to an instantaneous torque in N-m.

(C) Dynamometer mode when idling (speed-control or torque-control).

(D) Measured engine speed when idling.

(E) Transmission output angular speed,  $f_{ni,transmission}$ , calculated as follows:

$$f_{ni,transmission} = \frac{k_a[speed] \cdot v_{refi}}{2 \cdot \pi \cdot r_{[speed]}}$$

Eq. 1037.550-2

Where:

$k_a[speed]$  = drive axle ratio as determined in paragraph (h) of this section.

$v_{refi}$  = simulated vehicle reference speed as calculated in paragraph (f)(3) of this section.

$r_{[speed]}$  = tire radius as determined in paragraph (h) of this section.

(ii) The transmission submodel generates the following model outputs:

(A) Dynamometer target speed.

(B) Dynamometer idle load.

(C) Transmission engine load limit.

(D) Engine speed target.

(3) *Vehicle model*. Calculate the simulated vehicle reference speed,  $v_{refi}$ , using the GEM HIL model's vehicle submodel or the equations in this paragraph (f)(3):

$$v_{refi} = \left( \frac{k_a \cdot T_{i-1}}{r} \cdot (Eff_{axle}) - \left( M \cdot g \cdot C_{rr} \cdot \cos(\text{atan}(G_{i-1})) + \frac{\rho \cdot C_d A}{2} \cdot v_{ref,i-1}^2 \right) - F_{brake,i-1} - F_{grade,i-1} \right) \cdot \frac{\Delta t_{i-1}}{M + M_{rotating}} + v_{ref,i-1}$$

Eq. 1037.550-3

Where:

$i$  = a time-based counter corresponding to each measurement during the sampling period. Let  $v_{ref1} = 0$ ; start calculations at  $i = 2$ . A 10-minute sampling period will generally involve 60,000 measurements.

$T$  = instantaneous measured torque at the axle input, measured at the wheel hubs, or simulated by the GEM HIL model's transmission submodel.

$Eff_{axle}$  = axle efficiency. Use  $Eff_{axle} = 0.955$  for  $T \geq 0$ , and use  $Eff_{axle} = 1/0.955$  for  $T < 0$ .

Use  $Eff_{axle} = 1.0$  if torque is measured at the wheel hubs.

$M$  = vehicle mass for a vehicle class as determined in paragraph (h) of this section.

$g$  = gravitational constant = 9.80665 m/s<sup>2</sup>.

$C_{rr}$  = coefficient of rolling resistance for a vehicle class as determined in paragraph (h) of this section.

$G_{i-1}$  = the percent grade interpolated at distance,  $D_{i-1}$ , from the duty cycle in

appendix D to this part corresponding to measurement  $i-1$ .

$$D_{i-1} = \sum_{i=1}^N (v_{ref,i-1} \cdot \Delta t_{i-1})$$

Eq. 1037.550-4

$\rho$  = air density at reference conditions. Use  $\rho = 1.1845$  kg/m<sup>3</sup>.

$C_d A$  = drag area for a vehicle class as determined in paragraph (h) of this section.

$F_{brake,i-1}$  = instantaneous braking force applied by the driver model.

$F_{grade,i-1} = M \cdot g \cdot \sin(\text{atan}(G_{i-1}))$

Eq. 1037.550-5

$\Delta t$  = the time interval between measurements. For example, at 100 Hz,  $\Delta t = 0.0100$  seconds.

$M_{rotating}$  = inertial mass of rotating components. Let  $M_{rotating} = 340$  kg for vocational Light HDV or vocational Medium HDV. See paragraph (h) of this section for tractors and for vocational Heavy HDV.

(4) *Example*. The following example illustrates a calculation of  $f_{nref,dyno}$  using paragraph (f)(1) of this section where torque is measured at the axle input shaft. This example is for a vocational Light HDV or vocational Medium HDV with 6 speed automatic transmission at B speed (Test 4 in Table 1 to paragraph (h)(2)(ii) of this section).

$k_{aB} = 4.0$

$r_B = 0.399$  m

$T_{999} = 500.0$  N-m

$C_{rr} = 7.7$  N/kN =  $7.7 \cdot 10^{-3}$  N/N

$M = 11408$  kg

$C_d A = 5.4$  m<sup>2</sup>

$G_{999} = 0.39\% = 0.0039$

$$D_{999} = \sum_{i=0}^{998} (19.99 \cdot 0.01 + 20.0 \cdot 0.01 + \dots + v_{ref,998} \cdot \Delta t_{998}) = 1792 \text{ m}$$

$F_{brake,999} = 0$  N

$v_{ref,999} = 20.0$  m/s

$\Delta t = 0.0100$  s

$M_{rotating} = 340$  kg

$$v_{ref1000} = \left( \frac{4.0 \cdot 500.0}{0.399} \cdot (0.955) - \left( 11408 \cdot 9.80665 \cdot 7.7 \cdot 10^{-3} \cdot \cos(\text{atan}(0.0039)) + \frac{1.1845 \cdot 5.4}{2} \cdot 20.0^2 \right) - 0 - 436.5 \right) \cdot \frac{0.0100}{11408 + 340} + 20.0 v_{ref1000}$$

$$v_{ref1000} = 20.00189 \text{ m/s}$$

$$f_{\text{href1000,dyno}} = \frac{4.0 \cdot 20.00189}{2 \cdot 3.14 \cdot 0.399}$$

$$f_{\text{href1000,dyno}} = 31.93 \text{ r/s} = 1915.8 \text{ r/min}$$

(g) *Driver model.* Use the GEM HIL model's driver submodel or design a driver model to simulate a human driver modulating the throttle and brake pedals. In either case, tune the model to follow the test cycle as closely as possible meeting the following specifications:

- (1) The driver model must meet the following speed requirements:
  - (i) For operation over the highway cruise cycles, the speed requirements described in 40 CFR 1066.425(b) and (c).
  - (ii) For operation over the transient cycle specified in appendix A of this

part, the SET as defined 40 CFR 1036.510, the Federal Test Procedure (FTP) as defined in 40 CFR 1036.512, and the Low Load Cycle (LLC) as defined in 40 CFR 1036.514, the speed requirements described in 40 CFR 1066.425(b) and (c).

- (iii) The exceptions in 40 CFR 1066.425(b)(4) apply to the highway cruise cycles, the transient cycle specified in appendix A of this part, SET, FTP, and LLC.
- (iv) If the speeds do not conform to these criteria, the test is not valid and must be repeated.

(2) Send a brake signal when operator demand is zero and vehicle speed is greater than the reference vehicle speed from the test cycle. Include a delay before changing the brake signal to prevent dithering, consistent with good engineering judgment.

- (3) Allow braking only if operator demand is zero.
- (4) Compensate for the distance driven over the duty cycle over the course of the test. Use the following equation to perform the compensation in real time to determine your time in the cycle:

$$t_{\text{cycle}i} = \sum_{i=1}^N \left( \left( \frac{v_{\text{vehicle},i-1}}{v_{\text{cycle},i-1}} \right) \cdot \Delta t_{i-1} \right)$$

Eq. 1037.550-6

Where:

$v_{\text{vehicle}}$  = measured vehicle speed.  
 $v_{\text{cycle}}$  = reference speed from the test cycle.  
 If  $v_{\text{cycle},i-1} < 1.0 \text{ m/s}$ , set  $v_{\text{cycle},i-1} = v_{\text{vehicle},i-1}$ .

(h) *Vehicle configurations to evaluate for generating fuel maps as defined in 40 CFR 1036.505.* Configure the driveline and vehicle models from paragraph (f) of this section in the test cell to test the powertrain. Simulate multiple vehicle configurations that represent the range of intended vehicle applications using one of the following options:

- (1) For known vehicle configurations, use at least three equally spaced axle ratios or tire sizes and three different road loads (nine configurations), or at least four equally spaced axle ratios or

tire sizes and two different road loads (eight configurations). Select axle ratios to represent the full range of expected vehicle installations. Select axle ratios and tire sizes such that the ratio of engine speed to vehicle speed covers the range of ratios of minimum and maximum engine speed to vehicle speed when the transmission is in top gear for the vehicles in which the powertrain will be installed. Note that you do not have to use the same axle ratios and tire sizes for each GEM regulatory subcategory. You may determine appropriate  $C_{rr}$ ,  $C_{dA}$ , and mass values to cover the range of intended vehicle applications or you may use the  $C_{rr}$ ,  $C_{dA}$ , and mass values specified in paragraph (h)(2) of this section.

(2) If vehicle configurations are not known, determine the vehicle model inputs for a set of vehicle configurations as described in 40 CFR 1036.540(c)(3) with the following exceptions:

- (i) In the equations of 40 CFR 1036.540(c)(3)(i),  $k_{\text{topgear}}$  is the actual top gear ratio of the powertrain instead of the transmission gear ratio in the highest available gear given in Table 1 in 40 CFR 1036.540.
- (ii) Test at least eight different vehicle configurations for powertrains that will be installed in Spark-ignition HDE, vocational Light HDV, and vocational Medium HDV using the following table instead of Table 2 in 40 CFR 1036.540:

Table 1 to Paragraph (h)(2)(ii) of § 1037.550—Vehicle Configurations for Testing Spark-ignition HDE, Light HDE, and Medium HDE

Parameter	1	2	3	4	5	6	7	8
$C_{rr}$ (N/kN)	6.2	7.7	6.2	7.7	6.2	7.7	6.2	7.7
$C_dA$	3.4	5.4	3.4	5.4	3.4	5.4	3.4	5.4
CI engine speed for $\frac{f_{ntire}}{v_{vehicle}}$ and $k_a$	$f_{nrefA}$	$f_{nrefA}$	$f_{nrefB}$	$f_{nrefB}$	$f_{nrefC}$	$f_{nrefC}$	$f_{ntest}$	$f_{ntest}$
SI engine speed for $\frac{f_{ntire}}{v_{vehicle}}$ and $k_a$	$f_{nrefD}$	$f_{nrefD}$	$f_{nrefA}$	$f_{nrefA}$	$f_{nrefB}$	$f_{nrefB}$	$f_{nrefC}$	$f_{nrefC}$
$M$ (kg)	7,257	11,408	7,257	11,408	7,257	11,408	7,257	11,408
$M_{rotating}$ (kg)	340	340	340	340	340	340	340	340
Drive axle configuration <sup>a</sup>	4x2	4x2	4x2	4x2	4x2	4x2	4x2	4x2
GEM regulatory subcategory <sup>a</sup>	LHD	MHD	LHD	MHD	LHD	MHD	LHD	MHD

<sup>a</sup>Drive axle configuration and GEM regulatory subcategory are not used if using the equations in paragraph (f)(3) of this section.

(iii) Select and test vehicle configurations as described in 40 CFR 1036.540(c)(3)(iii) for powertrains that

will be installed in vocational Heavy HDV and tractors using the following

tables instead of Table 3 and Table 4 in 40 CFR 1036.540:



Table 2 to Paragraph (h)(2)(iii) of § 1037.550—Vehicle Configurations for Testing General Purpose Tractors and Vocational Heavy HDV

Parameter	1	2	3	4	5	6	7	8	9
kN)	6.9	6.9	6.9	6.9	6.9	6.9	6.9	6.9	6.9
	5.4	4.7	4.0	5.4	4.7	4.0	5.4	4.7	4.0
speed for $\frac{f_{ntire}}{v_{vehicle}}$	$f_{nrefD}$	$f_{nrefD}$	$f_{nrefD}$	$f_{nrefB}$	$f_{nrefB}$	$f_{nrefB}$	$f_{ntest}$	$f_{ntest}$	$f_{ntest}$
	1,978	5,515	9,051	1,978	5,515	9,051	1,978	5,515	9,051
$m_e$ (kg)	1,021	794	794	1,021	794	794	1,021	794	794
axle configuration <sup>a</sup>	6x4	6x4	4x2	6x4	6x4	4x2	6x4	6x4	4x2
regulatory category <sup>a</sup>	SC_HR	DC_MR	DC_MR	SC_HR	DC_MR	DC_MR	SC_HR	DC_MR	DC_MR
weight reduction	0	3,275	5,147	0	3,275	5,147	0	3,275	5,147

axle configuration and GEM regulatory subcategory are not used if using the equations in paragraph (f)(3) of this section.

Table 3 to Paragraph (h)(2)(iii) of § 1037.550—Vehicle Configurations for Testing Heavy HDE Installed in Heavy-Haul Tractors

Parameter	1	2	3	4	5	6
$C_{rr}$ (N/kN)	6.9	6.9	6.9	6.9	6.9	6.9
$C_dA$	5.0	5.4	5.0	5.4	5.0	5.4
Engine speed for $\frac{f_{ntire}}{v_{vehicle}}$ and $k_a$	$f_{nrefD}$	$f_{nrefD}$	$f_{nrefB}$	$f_{nrefB}$	$f_{ntest}$	$f_{ntest}$
$M$ (kg)	53,751	31,978	53,751	31,978	53,751	31,978
$M_{rotating}$ (kg)	1,021	1,021	1,021	1,021	1,021	1,021
Drive axle configuration <sup>a</sup>	6x4	6x4	6x4	6x4	6x4	6x4
GEM regulatory subcategory <sup>a</sup>	C8_HH	C8_SC_HR	C8_HH	C8_SC_HR	C8_HH	C8_SC_HR

<sup>a</sup>Drive axle configuration and GEM regulatory subcategory are not used if using the equations in paragraph (f)(3) of this section.

(3) For hybrid powertrain systems where the transmission will be simulated, use the transmission parameters defined in 40 CFR 1036.540(c)(2) to determine transmission type and gear ratio. Use a fixed transmission efficiency of 0.95. The GEM HIL transmission model uses a transmission parameter file for each test that includes the transmission type, gear ratios, lockup gear, torque limit per gear from 40 CFR 1036.540(c)(2), and the values from 40 CFR 1036.505(b)(4) and (c).

(i) [Reserved]

(j) *Duty cycles to evaluate.* Operate the powertrain over each of the duty cycles specified in § 1037.510(a)(2), and for each applicable vehicle configuration from paragraph (h) of this section. Determine cycle-average powertrain fuel maps by testing the powertrain using

the procedures in 40 CFR 1036.540(d) with the following exceptions:

(1) Understand “engine” to mean “powertrain”.

(2) Warm up the powertrain as described in 40 CFR 1036.520(c)(1).

(3) Within 90 seconds after concluding the warm-up, start the transition to the preconditioning cycle as described in paragraph (j)(5) of this section.

(4) For plug-in hybrid engines, precondition the battery and then complete all back-to-back tests for each vehicle configuration according to 40 CFR 1066.501 before moving to the next vehicle configuration.

(5) If the preceding duty cycle does not end at 0 mi/hr, transition between duty cycles by decelerating at a rate of 2 mi/hr/s at 0% grade until the vehicle reaches zero speed. Shut off the powertrain. Prepare the powertrain and test cell for the next duty-cycle.

(6) Start the next duty-cycle within 60 to 180 seconds after shutting off the powertrain.

(i) To start the next duty-cycle, for hybrid powertrains, key on the vehicle and then start the duty-cycle. For conventional powertrains key on the vehicle, start the engine, wait for the engine to stabilize at idle speed, and then start the duty-cycle.

(ii) If the duty-cycle does not start at 0 mi/hr, transition to the next duty cycle by accelerating at a target rate of 1 mi/hr/s at 0% grade. Stabilize for 10 seconds at the initial duty cycle conditions and start the duty-cycle.

(7) Calculate cycle work using GEM or the speed and torque from the driveline and vehicle models from paragraph (f) of this section to determine the sequence of duty cycles.

(8) Calculate the mass of fuel consumed for idle duty cycles as

described in paragraph (n) of this section.

(k) *Measuring NO<sub>x</sub> emissions.* Measure NO<sub>x</sub> emissions for each sampling period in grams. You may perform these measurements using a NO<sub>x</sub> emission-measurement system that meets the requirements of 40 CFR part 1065, subpart J. If a system malfunction prevents you from measuring NO<sub>x</sub> emissions during a test under this section but the test otherwise gives valid results, you may consider this a valid test and omit the NO<sub>x</sub> emission measurements; however, we may require you to repeat the test if we determine that you inappropriately voided the test with respect to NO<sub>x</sub> emission measurement.

(l) [Reserved]

(m) *Measured output speed validation.* For each test point, validate the measured output speed with the corresponding reference values. If the range of reference speed is less than 10 percent of the mean reference speed, you need to meet only the standard error of the estimate in Table 1 of this section. You may delete points when

the vehicle is stopped. If your speed measurement is not at the location of  $f_{nref}$ , correct your measured speed using the constant speed ratio between the two locations. Apply cycle-validation criteria for each separate transient or highway cruise cycle based on the following parameters:

TABLE 4 TO PARAGRAPH (m) OF § 1037.550—STATISTICAL CRITERIA FOR VALIDATING DUTY CYCLES

Parameter <sup>a</sup>	Speed control
Slope, $a_1$	$0.990 \leq a_1 \leq 1.010$ .
Absolute value of intercept, $ a_0 $ .	$\leq 2.0\%$ of maximum $f_{nref}$ speed.
Standard error of the estimate, <i>SEE</i> .	$\leq 2.0\%$ of maximum $f_{nref}$ speed.
Coefficient of determination, $r^2$ .	$\geq 0.990$ .

<sup>a</sup> Determine values for specified parameters as described in 40 CFR 1065.514(e) by comparing measured and reference values for  $f_{nref,dyno}$ .

(n) *Fuel consumption at idle.* Record measurements using direct and/or indirect measurement of fuel flow. Determine the fuel-consumption rates at idle for the applicable duty cycles described in § 1037.510(a)(2) as follows:

(1) *Direct fuel flow measurement.* Determine the corresponding mean values for mean idle fuel mass flow rate,  $\bar{m}_{fuelidle}$ , for each duty cycle, as applicable. Use of redundant direct fuel-flow measurements require our advance approval.

(2) *Indirect fuel flow measurement.* Record speed and torque and measure emissions and other inputs needed to run the chemical balance in 40 CFR 1065.655(c). Determine the corresponding mean values for each duty cycle. Use of redundant indirect fuel-flow measurements require our advance approval. Measure background concentration as described in 40 CFR 1036.535(b)(4)(ii). We recommend setting the CVS flow rate as low as possible to minimize background, but without introducing errors related to insufficient mixing or other operational considerations. Note that for this testing 40 CFR 1065.140(e) does not apply, including the minimum dilution ratio of 2:1 in the primary dilution stage. Calculate the idle fuel mass flow rate for each duty cycle,  $\bar{m}_{fuelidle}$ , for each set of vehicle settings, as follows:

$$\bar{m}_{fuelidle} = \frac{M_C}{w_{Cmeas}} \cdot \left( \bar{n}_{exh} \cdot \frac{\bar{x}_{Ccombdry}}{1 + \bar{x}_{H_2Oexhdry}} - \frac{\bar{m}_{CO_2DEF}}{M_{CO_2}} \right)$$

Eq. 1037.550-7

Where:

$M_C$  = molar mass of carbon.

$w_{Cmeas}$  = carbon mass fraction of fuel (or mixture of test fuels) as determined in 40 CFR 1065.655(d), except that you may not use the default properties in Table 2 of 40 CFR 1065.655 to determine  $\alpha$ ,  $\beta$ , and  $w_C$  for liquid fuels.

$\bar{n}_{exh}$  = the mean raw exhaust molar flow rate from which you measured emissions according to 40 CFR 1065.655.

$\bar{x}_{Ccombdry}$  = the mean concentration of carbon from fuel and any injected fluids in the exhaust per mole of dry exhaust.

$\bar{x}_{H_2Oexhdry}$  = the mean concentration of H<sub>2</sub>O in exhaust per mole of dry exhaust.

$\bar{m}_{CO_2DEF}$  = the mean CO<sub>2</sub> mass emission rate resulting from diesel exhaust fluid decomposition over the duty cycle as determined in 40 CFR 1036.535(b)(9). If your engine does not use diesel exhaust fluid, or if you choose not to perform this correction, set  $\bar{m}_{CO_2DEF}$  equal to 0.

$M_{CO_2}$  = molar mass of carbon dioxide.

*Example:*

$M_C = 12.0107$  g/mol

$w_{Cmeas} = 0.867$

$\bar{n}_{exh} = 25.534$  mol/s

$\bar{x}_{Ccombdry} = 2.805 \cdot 10^{-3}$  mol/mol

$\bar{x}_{H_2Oexhdry} = 3.53 \cdot 10^{-2}$  mol/mol

$\bar{m}_{CO_2DEF} = 0.0726$  g/s

$M_{CO_2} = 44.0095$

$$\bar{m}_{fuelidle} = \frac{12.0107}{0.867} \cdot \left( 25.534 \cdot \frac{2.805 \cdot 10^{-3}}{1 + 3.53 \cdot 10^{-2}} - \frac{0.0726}{44.0095} \right)$$

$\bar{m}_{fuelidle} = 0.405$  g/s = 1458.6 g/hr

(o) *Create GEM inputs.* Use the results of powertrain testing to determine GEM inputs for the different simulated vehicle configurations as follows:

(1) Correct the measured or calculated fuel masses,  $m_{fuel[cycle]}$ , and mean idle fuel mass flow rates,  $\bar{m}_{fuelidle}$ , if applicable, for each test result to a mass-specific net energy content of a reference fuel as described in 40 CFR 1036.535(e), replacing  $\bar{m}_{fuel}$  with  $m_{fuel[cycle]}$  where applicable in Eq. 1036.535-4.

(2) Declare fuel masses,  $m_{fuel[cycle]}$  and  $\bar{m}_{fuelidle}$ . Determine  $m_{fuel[cycle]}$  using the calculated fuel mass consumption values described in 40 CFR 1036.540(d)(12). In addition, declare mean fuel mass flow rate for each applicable idle duty cycle,  $\bar{m}_{fuelidle}$ . These declared values may not be lower than any corresponding measured values determined in this section. If you use both direct and indirect measurement of fuel flow, determine the corresponding declared values as

described in 40 CFR 1036.535(g)(2) and (3). These declared values, which serve as emission standards, collectively represent the powertrain fuel map for certification.

(3) For engines designed for plug-in hybrid electric vehicles, the mass of fuel for each cycle,  $m_{fuel[cycle]}$ , is the utility factor-weighted fuel mass,  $m_{fuelUF[cycle]}$ . This is determined by calculating  $m_{fuel}$  for the full charge-depleting and charge-sustaining portions of the test and

weighting the results, using the following equation:

$$m_{\text{fuelUF[cycle]}} = \sum_{i=1}^N [m_{\text{fuel[cycle]CDi}} \cdot (UF_{\text{DCDi}} - UF_{\text{DCDi-1}})] + \sum_{j=1}^M [m_{\text{fuel[cycle]CSj}}] \cdot \frac{(1 - UF_{\text{RCD}})}{M}$$

Eq. 1037.550-8

Where:

*i* = an indexing variable that represents one test interval.

*N* = total number of charge-depleting test intervals.

$m_{\text{fuel[cycle]CDi}}$  = total mass of fuel in the charge-depleting portion of the test for each test interval, *i*, starting from *i* = 1, including the test interval(s) from the transition phase.

$UF_{\text{DCDi}}$  = utility factor fraction at distance  $D_{\text{CDi}}$  from Eq. 1037.505-9 as determined by interpolating the approved utility factor curve for each test interval, *i*, starting from *i* = 1. Let  $UF_{\text{DCD0}} = 0$

*j* = an indexing variable that represents one test interval.

*M* = total number of charge-sustaining test intervals.

$m_{\text{fuel[cycle]CSj}}$  = total mass of fuel over the charge-sustaining portion of the test for each test interval, *j*, starting from *j* = 1.

$UF_{\text{RCD}}$  = utility factor fraction at the full charge-depleting distance,  $R_{\text{CD}}$ , as determined by interpolating the approved utility factor curve.  $R_{\text{CD}}$  is the cumulative distance driven over *N* charge-depleting test intervals.

$$D_{\text{CDi}} = \sum_{k=1}^Q (v_k \cdot \Delta t)$$

Eq. 1037.550-9

Where:

*k* = an indexing variable that represents one recorded velocity value.

*Q* = total number of measurements over the test interval.

*v* = vehicle velocity at each time step, *k*, starting from *k* = 1. For tests completed under this section, *v* is the vehicle velocity as determined by Eq. 1037.550-1. Note that this should include charge-depleting test intervals that start when the engine is not yet operating.

$\Delta t = 1/f_{\text{record}}$   
 $f_{\text{record}}$  = the record rate.

Example for the 55 mi/hr Cruise Cycle:

*Q* = 8790

$v_1 = 55.0$  mi/hr

$v_2 = 55.0$  mi/hr

$v_3 = 55.1$  mi/hr

$f_{\text{record}} = 10$  Hz

$\Delta t = 1/10$  Hz = 0.1 s

$$D_{\text{CD1}} = \sum_{k=1}^{8790} (55.0 \cdot 0.1 + 55.0 \cdot 0.1 + 55.1 \cdot 0.1 + v_{8790} \cdot \Delta t) = 13.4 \text{ mi}$$

$D_{\text{CD2}} = 13.4$  mi

$D_{\text{CD3}} = 13.4$  mi

*N* = 3

$UF_{\text{DCD1}} = 0.05$

$UF_{\text{DCD2}} = 0.11$

$UF_{\text{DCD3}} = 0.21$

$m_{\text{fuel55cruiseCD1}} = 0$  g

$m_{\text{fuel55cruiseCD2}} = 0$  g

$m_{\text{fuel55cruiseCD3}} = 1675.4$  g

*M* = 1

$m_{\text{fuel55cruiseCS}} = 4884.1$  g

$UF_{\text{RCD}} = 0.21$

$$m_{\text{fuelUF55cruise}} = [0 \cdot (0.05 - 0) + 0 \cdot (0.11 - 0.05) + 1675.4 \cdot (0.21 - 0.11)] + 4884.1 \cdot \frac{(1 - 0.21)}{1}$$

$m_{\text{fuelUF55cruise}} = 4026.0$  g

(4) For the transient cycle specified in § 1037.510(a)(2)(i), calculate powertrain output speed per unit of vehicle speed,

$$\left[ \frac{\bar{f}_{\text{powertrain}}}{\bar{v}_{\text{powertrain}}} \right]_{\text{[cycle]}}$$

using one of the following methods:

(i) For testing with torque measurement at the axle input shaft:

$$\left[ \frac{\bar{f}_{\text{powertrain}}}{\bar{v}_{\text{powertrain}}} \right]_{\text{[cycle]}} = \frac{k_a}{2 \cdot \pi \cdot r_{\text{[speed]}}}$$

Eq. 1037.550-10

Example:

$k_a = 4.0$

$r_B = 0.399$  m

$$\left[ \frac{\bar{f}_{\text{powertrain}}}{\bar{v}_{\text{powertrain}}} \right]_{\text{transienttest4}} = \frac{4.0}{2 \cdot 3.14 \cdot 0.399}$$

$$\left[ \frac{\bar{f}_{\text{powertrain}}}{\bar{v}_{\text{powertrain}}} \right]_{\text{transienttest4}} = 1.596 \text{ r/m}$$



■ 122. Amend § 1037.551 by revising the introductory text and paragraphs (b) and (c) to read as follows:

**§ 1037.551 Engine-based simulation of powertrain testing.**

Section 1037.550 describes how to measure fuel consumption over specific duty cycles with an engine coupled to a transmission; § 1037.550(a)(5) describes how to create equivalent duty cycles for repeating those same measurements with just the engine. This § 1037.551 describes how to perform this engine testing to simulate the powertrain test. These engine-based measurements may be used for selective enforcement audits as described in § 1037.301, as long as the test engine's operation represents the engine operation observed in the powertrain test. If we use this approach for confirmatory testing, when making compliance determinations, we will consider the uncertainty associated with this approach relative to full powertrain testing. Use of this approach for engine SEAs is optional for engine manufacturers.

\* \* \* \* \*

(b) Operate the engine over the applicable engine duty cycles corresponding to the vehicle cycles specified in § 1037.510(a)(2) for powertrain testing over the applicable vehicle simulations described in § 1037.550(j). Warm up the engine to prepare for the transient test or one of the highway cruise cycles by operating it one time over one of the simulations of the corresponding duty cycle. Warm up the engine to prepare for the idle test by operating it over a simulation of the 65-mi/hr highway cruise cycle for 600 seconds. Within 60 seconds after concluding the warm up cycle, start emission sampling while the engine operates over the duty cycle. You may perform any number of test runs directly in succession once the engine is warmed up. Perform cycle validation as described in 40 CFR 1065.514 for engine speed, torque, and power.

(c) Calculate the mass of fuel consumed as described in § 1037.550(n) and (o). Correct each measured value for the test fuel's mass-specific net energy content as described in 40 CFR 1036.550. Use these corrected values to determine whether the engine's emission levels conform to the declared fuel-consumption rates from the powertrain test.

■ 123. Amend § 1037.555 by revising the introductory text and paragraph (g) to read as follows:

**§ 1037.555 Special procedures for testing Phase 1 hybrid systems.**

This section describes a powertrain testing procedure for simulating a chassis test with a pre-transmission or post-transmission hybrid system to perform A to B testing of Phase 1 vehicles. These procedures may also be used to perform A to B testing with non-hybrid systems. See § 1037.550 for Phase 2 hybrid systems.

\* \* \* \* \*

(g) The driver model should be designed to follow the cycle as closely as possible and must meet the requirements of § 1037.510 for steady-state testing and 40 CFR 1066.425 for transient testing. The driver model should be designed so that the brake and throttle are not applied at the same time.

\* \* \* \* \*

■ 124. Amend § 1037.560 by revising paragraph (c) to read as follows:

**§ 1037.560 Axle efficiency test.**

\* \* \* \* \*

(c) Measure input and output speed and torque as described in 40 CFR 1065.210(b). You must use a speed-measurement system that meets an accuracy of ±0.05% of point. Use torque transducers that meet an accuracy requirement of ±1.0 N·m for unloaded test points and ±0.2% of the maximum tested axle input torque or output torque, respectively, for loaded test points. Calibrate and verify measurement instruments according to 40 CFR part 1065, subpart D. Command speed and torque at a minimum of 10 Hz, and record all data, including bulk oil temperature, at a minimum of 1 Hz mean values.

\* \* \* \* \*

■ 125. Amend § 1037.601 by revising paragraphs (a)(1) and (c) to read as follows:

**§ 1037.601 General compliance provisions.**

(a) \* \* \*

(1) Except as specifically allowed by this part or 40 CFR part 1068, it is a violation of 40 CFR 1068.101(a)(1) to introduce into U.S. commerce either a tractor or vocational vehicle that is not certified to the applicable requirements of this part or a tractor or vocational vehicle containing an engine that is not certified to the applicable requirements of 40 CFR part 86 or 1036. Further, it is a violation to introduce into U.S. commerce a Phase 1 tractor containing an engine not certified for use in tractors; or to introduce into U.S. commerce a vocational vehicle containing a Light HDE or Medium HDE not certified for use in vocational

vehicles. These prohibitions apply especially to the vehicle manufacturer. Note that this paragraph (a)(1) allows the use of Heavy heavy-duty tractor engines in vocational vehicles.

\* \* \* \* \*

(c) The prohibitions of 40 CFR 1068.101 apply for vehicles subject to the requirements of this part. The following specific provisions apply:

(1) The actions prohibited under this provision include introducing into U.S. commerce a complete or incomplete vehicle subject to the standards of this part where the vehicle is not covered by a valid certificate of conformity or exemption.

(2) Applying a Clean Idle sticker to a vehicles with an installed engine that is not certified to the NO<sub>x</sub> standard of 40 CFR 1036.104(b) violates the prohibition in 40 CFR 1068.101(b)(7)(iii).

\* \* \* \* \*

■ 126. Amend § 1037.605 by revising paragraphs (a) introductory text and (a)(4) to read as follows:

**§ 1037.605 Installing engines certified to alternate standards for specialty vehicles.**

(a) *General provisions.* This section allows vehicle manufacturers to introduce into U.S. commerce certain new motor vehicles using engines certified to alternate emission standards specified in 40 CFR 1036.605 for motor vehicle engines used in specialty vehicles. You may not install an engine certified to these alternate standards if there is an engine certified to the full set of requirements of 40 CFR part 1036 that has the appropriate physical and performance characteristics to power the vehicle. Note that, although these alternate emission standards are mostly equivalent to standards that apply for nonroad engines under 40 CFR part 1039 or 1048, they are specific to motor vehicle engines. The provisions of this section apply for the following types of specialty vehicles:

\* \* \* \* \*

(4) Through model year 2027, vehicles with a hybrid powertrain in which the engine provides energy only for the Rechargeable Energy Storage System.

\* \* \* \* \*

■ 127. Amend § 1037.615 by revising paragraph (f) to read as follows:

**§ 1037.615 Advanced technologies.**

\* \* \* \* \*

(f) For electric vehicles and for fuel cells powered by hydrogen, calculate CO<sub>2</sub> credits using an FEL of 0 g/ton-mile. Note that these vehicles are subject to compression-ignition standards for CO<sub>2</sub>.

\* \* \* \* \*

■ 128. Amend § 1037.635 by revising paragraph (b)(2) to read as follows:

**§ 1037.635 Glider kits and glider vehicles.**

\* \* \* \* \*

(b) \* \* \*

(2) The engine must meet the criteria pollutant standards of 40 CFR part 86 or 40 CFR part 1036 that apply for the engine model year corresponding to the vehicle's date of manufacture.

\* \* \* \* \*

■ 129. Amend § 1037.705 by revising paragraph (b) to read as follows:

**§ 1037.705 Generating and calculating emission credits.**

\* \* \* \* \*

(b) For each participating family or subfamily, calculate positive or negative emission credits relative to the otherwise applicable emission standard. Calculate positive emission credits for a family or subfamily that has an FEL below the standard. Calculate negative emission credits for a family or subfamily that has an FEL above the standard. Sum your positive and negative credits for the model year before rounding. Round the sum of emission credits to the nearest megagram (Mg), using consistent units with the following equation:

$$\text{Emission credits (Mg)} = (\text{Std} - \text{FEL}) \times \text{PL} \times \text{Volume} \times \text{UL} \times 10^{-6}$$

Where:

*Std* = the emission standard associated with the specific regulatory subcategory (g/ton-mile).

*FEL* = the family emission limit for the vehicle subfamily (g/ton-mile).

*PL* = standard payload, in tons.

*Volume* = U.S.-directed production volume of the vehicle subfamily. For example, if you produce three configurations with the same FEL, the subfamily production volume would be the sum of the production volumes for these three configurations.

*UL* = useful life of the vehicle, in miles, as described in §§ 1037.105 and 1037.106. Use 250,000 miles for trailers.

\* \* \* \* \*

■ 130. Amend § 1037.725 by revising the section heading to read as follows:

**§ 1037.725 Required information for certification.**

\* \* \* \* \*

■ 131. Amend § 1037.730 by revising paragraphs (a), (b) introductory text, (c), and (f) to read as follows:

**§ 1037.730 ABT reports.**

(a) If you certify any vehicle families using the ABT provisions of this subpart, send us a final report by September 30 following the end of the model year.

(b) Your report must include the following information for each vehicle

family participating in the ABT program:

\* \* \* \* \*

(c) Your report must include the following additional information:

(1) Show that your net balance of emission credits from all your participating vehicle families in each averaging set in the applicable model year is not negative, except as allowed under § 1037.745. Your credit tracking must account for the limitation on credit life under § 1037.740(c).

(2) State whether you will retain any emission credits for banking. If you choose to retire emission credits that would otherwise be eligible for banking, identify the families that generated the emission credits, including the number of emission credits from each family.

(3) State that the report's contents are accurate.

(4) Identify the technologies that make up the certified configuration associated with each vehicle identification number. You may identify this as a range of identification numbers for vehicles involving a single, identical certified configuration.

\* \* \* \* \*

(f) Correct errors in your report as follows:

(1) If you or we determine by September 30 after the end of the model year that errors mistakenly decreased your balance of emission credits, you may correct the errors and recalculate the balance of emission credits. You may not make these corrections for errors that are determined later than September 30 after the end of the model year. If you report a negative balance of emission credits, we may disallow corrections under this paragraph (f)(1).

(2) If you or we determine any time that errors mistakenly increased your balance of emission credits, you must correct the errors and recalculate the balance of emission credits.

■ 132. Amend § 1037.735 by revising paragraph (b) to read as follows:

**§ 1037.735 Recordkeeping.**

\* \* \* \* \*

(b) Keep the records required by this section for at least eight years after the due date for the final report. You may not use emission credits for any vehicles if you do not keep all the records required under this section. You must therefore keep these records to continue to bank valid credits.

\* \* \* \* \*

■ 133. Amend § 1037.740 by revising paragraph (b) to read as follows:

**§ 1037.740 Restrictions for using emission credits.**

\* \* \* \* \*

(b) *Credits from hybrid vehicles and other advanced technologies.* The following provisions apply for credits you generate under § 1037.615.

(1) Credits generated from Phase 1 vehicles may be used for any of the averaging sets identified in paragraph (a) of this section; you may also use those credits to demonstrate compliance with the CO<sub>2</sub> emission standards in 40 CFR 86.1819 and 40 CFR part 1036. Similarly, you may use Phase 1 advanced-technology credits generated under 40 CFR 86.1819–14(k)(7) or 40 CFR 1036.615 to demonstrate compliance with the CO<sub>2</sub> standards in this part. The maximum amount of advanced-technology credits generated from Phase 1 vehicles that you may bring into each of the following service class groups is 60,000 Mg per model year:

(i) Spark-ignition HDE, Light HDE, and Light HDV. This group comprises the averaging set listed in paragraph (a)(1) of this section and the averaging set listed in 40 CFR 1036.740(a)(1) and (2).

(ii) Medium HDE and Medium HDV. This group comprises the averaging sets listed in paragraph (a)(2) of this section and 40 CFR 1036.740(a)(3).

(iii) Heavy HDE and Heavy HDV. This group comprises the averaging sets listed in paragraph (a)(3) of this section and 40 CFR 1036.740(a)(4).

(iv) This paragraph (b)(1) does not limit the advanced-technology credits that can be used within a service class group if they were generated in that same service class group.

(2) Credits generated from Phase 2 vehicles are subject to all the averaging-set restrictions that apply to other emission credits.

\* \* \* \* \*

■ 134. Amend § 1037.801 by:

■ a. Revising the definitions of “Adjustable parameter”, “Automatic tire inflation system”, and “Automatic transmission (AT)”;

■ b. Adding definitions of “Charge-depleting”, and “Charge-sustaining” in alphabetical order;

■ c. Revising the definitions of “Designated Compliance Officer” and of “Electric vehicle”;

■ d. Adding a definition of “Emission-related component” in alphabetical order; and

■ e. Revising the definitions of “Low rolling resistance tire”, “Neutral coasting”, “Rechargeable Energy Storage System (RESS)”, and “Tire rolling resistance level (TRRL)”.

The additions and revisions read as follows:

**§ 1037.801 Definitions.**

\* \* \* \* \*

*Adjustable parameter* has the meaning given in 40 CFR 1068.30.

\* \* \* \* \*

*Automatic tire inflation system* means a pneumatically or electronically activated system installed on a vehicle to maintain tire pressure at a preset level. These systems eliminate the need to manually inflate tires. Note that this is different than a *tire pressure monitoring system*, which we define separately in this section.

*Automatic transmission (AT)* means a transmission with a torque converter (or equivalent) that uses computerize or other internal controls to shift gears in response to a single driver input for controlling vehicle speed.. Note that automatic manual transmissions are not automatic transmissions because they do not include torque converters.

\* \* \* \* \*

*Charge-depleting* has the meaning given in 40 CFR 1066.1001.

*Charge-sustaining* has the meaning given in 40 CFR 1066.1001.

\* \* \* \* \*

*Designated Compliance Officer* means one of the following:

(1) For compression-ignition engines, *Designated Compliance Officer* means Director, Diesel Engine Compliance Center, U.S. Environmental Protection Agency, 2000 Traverwood Drive, Ann Arbor, MI 48105; *complianceinfo@epa.gov*; *www.epa.gov/ve-certification*.

(2) For spark-ignition engines, *Designated Compliance Officer* means Director, Gasoline Engine Compliance Center, U.S. Environmental Protection Agency, 2000 Traverwood Drive, Ann

Arbor, MI 48105; *complianceinfo@epa.gov*; *www.epa.gov/ve-certification*.

\* \* \* \* \*

*Electric vehicle* means a motor vehicle that does not include an engine, and is powered solely by an external source of electricity and/or solar power. Note that this definition does not include hybrid electric vehicles or fuel cell vehicles that use a chemical fuel such as gasoline, diesel fuel, or hydrogen. Electric vehicles may also be referred to as all-electric vehicles to distinguish them from hybrid vehicles.

\* \* \* \* \*

*Emission-related component* has the meaning given in 40 CFR part 1068, appendix A.

\* \* \* \* \*

*Low rolling resistance tire* means a tire on a vocational vehicle with a TRRL at or below of 7.7 N/kN, a steer tire on a tractor with a TRRL at or below 7.7 N/kN, a drive tire on a tractor with a TRRL at or below 8.1 N/kN, a tire on a non-box trailer with a TRRL at or below of 6.5 N/kN, or a tire on a box van with a TRRL at or below of 6.0 N/kN.

\* \* \* \* \*

*Neutral coasting* means a vehicle technology that automatically puts the transmission in neutral when the vehicle has minimal power demand while in motion, such as driving downhill.

\* \* \* \* \*

*Rechargeable Energy Storage System (RESS)* has the meaning given in 40 CFR 1065.1001.

\* \* \* \* \*

*Tire rolling resistance level (TRRL)* means a value with units of N/kN that represents the rolling resistance of a tire configuration. TRRLs are used as

modeling inputs under §§ 1037.515 and 1037.520. Note that a manufacturer may use the measured value for a tire configuration's coefficient of rolling resistance, or assign some higher value.

\* \* \* \* \*

■ 135. Amend § 1037.805 by revising paragraphs (a), (b), (d), (e), (f), and (g) to read as follows:

**§ 1037.805 Symbols, abbreviations, and acronyms.**

\* \* \* \* \*

(a) *Symbols for chemical species.* This part uses the following symbols for chemical species and exhaust constituents:

TABLE 1 TO PARAGRAPH (a) OF § 1037.805—SYMBOLS FOR CHEMICAL SPECIES AND EXHAUST CONSTITUENTS

Symbol	Species
C	carbon.
CH <sub>4</sub>	methane.
CO	carbon monoxide.
CO <sub>2</sub>	carbon dioxide.
H <sub>2</sub> O	water.
HC	hydrocarbon.
NMHC	nonmethane hydrocarbon.
NMHCE	nonmethane hydrocarbon equivalent.
NO	nitric oxide.
NO <sub>2</sub>	nitrogen dioxide.
NO <sub>x</sub>	oxides of nitrogen.
N <sub>2</sub> O	nitrous oxide.
PM	particulate matter.
THC	total hydrocarbon.
THCE	total hydrocarbon equivalent.

(b) *Symbols for quantities.* This part 1037 uses the following symbols and units of measure for various quantities:

TABLE 2 TO PARAGRAPH (b) OF § 1037.805—SYMBOLS FOR QUANTITIES

Symbol	Quantity	Unit	Unit symbol	Unit in terms of SI base units
A	vehicle frictional load	pound force or newton	lbf or N	kg·m·s <sup>-2</sup> .
a	axle position regression coefficient.			
α	atomic hydrogen-to-carbon ratio	mole per mole	mol/mol	1.
α	axle position regression coefficient.			
α <sub>0</sub>	intercept of air speed correction.			
α <sub>1</sub>	slope of air speed correction.			
a <sub>g</sub>	acceleration of Earth's gravity	meters per second squared	m/s <sup>2</sup>	m·s <sup>-2</sup> .
a <sub>0</sub>	intercept of least squares regression.			
a <sub>1</sub>	slope of least squares regression.			
B	vehicle load from drag and rolling resistance.	pound force per mile per hour or newton second per meter.	lbf/(mi/hr) or N·s/m	kg·s <sup>-1</sup> .
b	axle position regression coefficient.			
β	atomic oxygen-to-carbon ratio	mole per mole	mol/mol	1.
β	axle position regression coefficient.			
β <sub>0</sub>	intercept of air direction correction.			
β <sub>1</sub>	slope of air direction correction.			
C	vehicle-specific aerodynamic effects	pound force per mile per hour squared or newton-second squared per meter squared.	lbf/mph <sup>2</sup> or N·s <sup>2</sup> /m <sup>2</sup>	kg·m <sup>-1</sup> .
c	axle position regression coefficient.			

TABLE 2 TO PARAGRAPH (b) OF § 1037.805—SYMBOLS FOR QUANTITIES—Continued

Symbol	Quantity	Unit	Unit symbol	Unit in terms of SI base units
$c_1$ .....	axle test regression coefficients.			
$C_1$ .....	constant.			
$\Delta C_d A$ .....	differential drag area .....	meter squared .....	$m^2$ .....	$m^2$ .
$C_d A$ .....	drag area .....	meter squared .....	$m^2$ .....	$m^2$ .
$C_d$ .....	drag coefficient.			
$CF$ .....	correction factor.			
$C_{rr}$ .....	coefficient of rolling resistance .....	newton per kilonewton .....	N/kN .....	$10^{-3}$ .
$D$ .....	distance .....	miles or meters .....	mi or m .....	m.
$e$ .....	mass-weighted emission result .....	grams per ton-mile .....	g/ton-mi .....	g/kg-km.
$Eff$ .....	efficiency.			
$F$ .....	adjustment factor.			
$F$ .....	force .....	pound force or newton .....	lbf or N .....	$kg \cdot m \cdot s^{-2}$ .
$f_n$ .....	angular speed (shaft) .....	revolutions per minute .....	r/min .....	$\pi \cdot 30 \cdot s^{-1}$ .
$G$ .....	road grade .....	percent .....	% .....	$10^{-2}$ .
$g$ .....	gravitational acceleration .....	meters per second squared .....	$m/s^2$ .....	$m \cdot s^{-2}$ .
$h$ .....	elevation or height .....	meters .....	m .....	m.
$i$ .....	indexing variable.			
$k_a$ .....	drive axle ratio .....			1.
$k_d$ .....	transmission gear ratio.			
$k_{topgear}$ .....	highest available transmission gear.			
$L$ .....	load over axle .....	pound force or newton .....	lbf or N .....	$kg \cdot m \cdot s^{-2}$ .
$m$ .....	mass .....	pound mass or kilogram .....	lbm or kg .....	kg.
$M$ .....	molar mass .....	gram per mole .....	g/mol .....	$10^{-3} \cdot kg \cdot mol^{-1}$ .
$M$ .....	vehicle mass .....	kilogram .....	kg .....	kg.
$M_e$ .....	vehicle effective mass .....	kilogram .....	kg .....	kg.
$M_{rotating}$ .....	inertial mass of rotating components .....	kilogram .....	kg .....	kg.
$N$ .....	total number in series.			
$n$ .....	number of tires.			
$\dot{n}$ .....	amount of substance rate .....	mole per second .....	mol/s .....	$mol \cdot s^{-1}$ .
$P$ .....	power .....	kilowatt .....	kW .....	$10^3 \cdot m^2 \cdot kg \cdot s^{-3}$ .
$p$ .....	pressure .....	pascal .....	Pa .....	$kg \cdot m^{-1} \cdot s^{-2}$ .
$\rho$ .....	mass density .....	kilogram per cubic meter .....	$kg/m^3$ .....	$kg \cdot m^{-3}$ .
$PL$ .....	payload .....	tons .....	ton .....	kg.
$\varphi$ .....	direction .....	degrees .....	$^\circ$ .....	$^\circ$ .
$\psi$ .....	direction .....	degrees .....	$^\circ$ .....	$^\circ$ .
$r$ .....	tire radius .....	meter .....	m .....	m.
$r^2$ .....	coefficient of determination.			
$Re^\#$ .....	Reynolds number.			
$SEE$ .....	standard error of the estimate.			
$\sigma$ .....	standard deviation.			
$TRPM$ .....	tire revolutions per mile .....	revolutions per mile .....	r/mi.	
$TRRL$ .....	tire rolling resistance level .....	newton per kilonewton .....	N/kN .....	$10^{-3}$ .
$T$ .....	absolute temperature .....	kelvin .....	K .....	K.
$T$ .....	Celsius temperature .....	degree Celsius .....	$^\circ C$ .....	$K - 273.15$ .
$T$ .....	torque (moment of force) .....	newton meter .....	N·m .....	$m^2 \cdot kg \cdot s^{-2}$ .
$t$ .....	time .....	hour or second .....	hr or s .....	s.
$\Delta t$ .....	time interval, period, 1/frequency .....	second .....	s .....	s.
$UF$ .....	utility factor.			
$v$ .....	speed .....	miles per hour or meters per second .....	mi/hr or m/s .....	$m \cdot s^{-1}$ .
$w$ .....	weighting factor.			
$w$ .....	wind speed .....	miles per hour .....	mi/hr .....	$m \cdot s^{-1}$ .
$W$ .....	work .....	kilowatt-hour .....	kW·hr .....	$3.6 \cdot m^2 \cdot kg \cdot s^{-1}$ .
$w_C$ .....	carbon mass fraction .....	gram per gram .....	g/g .....	1.
$WR$ .....	weight reduction .....	pound mass .....	lbm .....	kg.
$x$ .....	amount of substance mole fraction .....	mole per mole .....	mol/mol .....	1.

\* \* \* \* \*

(d) *Subscripts.* This part uses the following subscripts for modifying quantity symbols:

TABLE 4 TO PARAGRAPH (d) OF § 1037.805—SUBSCRIPTS

Subscript	Meaning
$\pm 6$ .....	$\pm 6^\circ$ yaw angle sweep.
A .....	A speed.
air .....	air.
aero .....	aerodynamic.



TABLE 4 TO PARAGRAPH (d) OF § 1037.805—SUBSCRIPTS—Continued

Subscript	Meaning
alt .....	alternative.
act .....	actual or measured condition.
air .....	air.
axle .....	axle.
B .....	B speed.
brake .....	brake.
C .....	C speed.
Ccombdry .....	carbon from fuel per mole of dry exhaust.
CD .....	charge-depleting.
circuit .....	circuit.
CO <sub>2</sub> DEF .....	CO <sub>2</sub> resulting from diesel exhaust fluid decomposition.
CO <sub>2</sub> PTO .....	CO <sub>2</sub> emissions for PTO cycle.
coastdown .....	coastdown.
comp .....	composite.
CS .....	charge-sustaining.
cycle .....	test cycle.
drive .....	drive axle.
drive-idle .....	idle with the transmission in drive.
driver .....	driver.
dyno .....	dynamometer.
effective .....	effective.
end .....	end.
eng .....	engine.
event .....	event.
fuel .....	fuel.
full .....	full.
grade .....	grade.
H <sub>2</sub> Oexhaustdry .....	H <sub>2</sub> O in exhaust per mole of exhaust.
hi .....	high.
i .....	an individual of a series.
idle .....	idle.
in .....	inlet.
inc .....	increment.
lo .....	low.
loss .....	loss.
max .....	maximum.
meas .....	measured quantity.
med .....	median.
min .....	minimum.
moving .....	moving.
out .....	outlet.
P .....	power.
pair .....	pair of speed segments.
parked-idle .....	idle with the transmission in park.
partial .....	partial.
ploss .....	power loss.
plug-in .....	plug-in hybrid electric vehicle.
powertrain .....	powertrain.
PTO .....	power take-off.
rated .....	rated speed.
record .....	record.
ref .....	reference quantity.
RL .....	road load.
rotating .....	rotating.
seg .....	segment.
speed .....	speed.
spin .....	axle spin loss.
start .....	start.
steer .....	steer axle.
t .....	tire.
test .....	test.
th .....	theoretical.
total .....	total.
trac .....	traction.
trac10 .....	traction force at 10 mi/hr.
trailer .....	trailer axle.
transient .....	transient.
TRR .....	tire rolling resistance.
UF .....	utility factor.
urea .....	urea.
veh .....	vehicle.
w .....	wind.

TABLE 4 TO PARAGRAPH (d) OF § 1037.805—SUBSCRIPTS—Continued

Subscript	Meaning
wa .....	wind average.
yaw .....	yaw angle.
ys .....	yaw sweep.
zero .....	zero quantity.

(e) *Other acronyms and abbreviations.*  
 This part uses the following additional abbreviations and acronyms:

TABLE 5 TO PARAGRAPH (e) OF § 1037.805—OTHER ACRONYMS AND ABBREVIATIONS

Acronym	Meaning
ABT .....	averaging, banking, and trading.
AECD .....	auxiliary emission control device.
AES .....	automatic engine shutdown.
APU .....	auxiliary power unit.
CD .....	charge-depleting.
CFD .....	computational fluid dynamics.
CFR .....	Code of Federal Regulations.
CITT .....	curb idle transmission torque.
CS .....	charge-sustaining.
DOT .....	Department of Transportation.
ECM .....	electronic control module.
EPA .....	Environmental Protection Agency.
FE .....	fuel economy.
FEL .....	Family Emission Limit.
FTP .....	Federal Test Procedure.
GAWR .....	gross axle weight rating.
GCWR .....	gross combination weight rating.
GEM .....	greenhouse gas emission model.
GVWR .....	gross vehicle weight rating.
Heavy HDE .....	heavy heavy-duty engine (see 40 CFR 1036.140).
Heavy HDV .....	heavy heavy-duty vehicle (see § 1037.140).
HVAC .....	heating, ventilating, and air conditioning.
ISO .....	International Organization for Standardization.
Light HDE .....	light heavy-duty engine (see 40 CFR 1036.140).
Light HDV .....	light heavy-duty vehicle (see § 1037.140).
LLC .....	Low Load Cycle.
Medium HDE .....	medium heavy-duty engine (see 40 CFR 1036.140).
Medium HDV .....	medium heavy-duty vehicle (see § 1037.140).
NARA .....	National Archives and Records Administration.
NHTSA .....	National Highway Transportation Safety Administration.
PHEV .....	plug-in hybrid electric vehicle.
PTO .....	power take-off.
RESS .....	rechargeable energy storage system.
SAE .....	SAE International.
SEE .....	standard error of the estimate.
SET .....	Supplemental Emission Test.
SKU .....	stock-keeping unit.
Spark-ignition HDE .....	spark-ignition heavy-duty engine (see 40 CFR 1036.140).
TRPM .....	tire revolutions per mile.
TRRL .....	tire rolling resistance level.
U.S.C .....	United States Code.
VSL .....	vehicle speed limiter.

(f) *Constants.* This part uses the following constants:

TABLE 6 TO PARAGRAPH (f) OF § 1037.805—CONSTANTS

Symbol	Quantity	Value
<i>g</i> .....	gravitational constant.	9.80665 m. <sup>-2</sup> .

TABLE 6 TO PARAGRAPH (f) OF § 1037.805—CONSTANTS—Continued

Symbol	Quantity	Value
<i>R</i> .....	specific gas constant.	287.058 J/ (kg·K).

(g) *Prefixes.* This part uses the following prefixes to define a quantity:

TABLE 7 TO PARAGRAPH (g) OF § 1037.805—PREFIXES

Symbol	Quantity	Value
$\mu$ .....	micro .....	10 <sup>-6</sup>
m .....	milli .....	10 <sup>-3</sup>
c .....	centi .....	10 <sup>-2</sup>
k .....	kilo .....	10 <sup>3</sup>
M .....	mega .....	10 <sup>6</sup>

■ 136. Revise § 1037.810 to read as follows:

**§ 1037.810 Incorporation by reference.**

Certain material is incorporated by reference into this part with the approval of the Director of the Federal Register under 5 U.S.C. 552(a) and 1 CFR part 51. To enforce any edition other than that specified in this section, EPA must publish a document in the **Federal Register** and the material must be available to the public. All approved incorporation by reference (IBR) material is available for inspection at EPA and at the National Archives and Records Administration (NARA). Contact EPA at: U.S. EPA, Air and Radiation Docket Center, WJC West Building, Room 3334, 1301 Constitution Ave. NW, Washington, DC 20004; [www.epa.gov/dockets](http://www.epa.gov/dockets); (202) 202-1744. For information on inspecting this material at NARA, visit [www.archives.gov/federal-register/cfr/ibr-locations.html](http://www.archives.gov/federal-register/cfr/ibr-locations.html) or email [fr.inspection@nara.gov](mailto:fr.inspection@nara.gov). The material may be obtained from the following sources:

(a) International Organization for Standardization, Case Postale 56, CH-1211 Geneva 20, Switzerland; (41) 22749 0111; [www.iso.org](http://www.iso.org); or [central@iso.org](mailto:central@iso.org).

(1) ISO 28580:2009(E) “Passenger car, truck and bus tyres—Methods of measuring rolling resistance—Single point test and correlation of measurement results”, First Edition, July 1, 2009, (“ISO 28580”); IBR approved for § 1037.520(c).

(2) [Reserved]

(b) National Institute of Standards and Technology (NIST), 100 Bureau Drive, Stop 1070, Gaithersburg, MD 20899-1070; (301) 975-6478; [www.nist.gov](http://www.nist.gov).

(1) NIST Special Publication 811, 2008 Edition, Guide for the Use of the International System of Units (SI), Physics Laboratory, March 2008; IBR approved for § 1037.805.

(2) [Reserved]

(c) SAE International, 400 Commonwealth Dr., Warrendale, PA 15096-0001, (877) 606-7323 (U.S. and Canada) or (724) 776-4970 (outside the U.S. and Canada), [www.sae.org](http://www.sae.org).

(1) SAE J1025 AUG2012, Test Procedures for Measuring Truck Tire Revolutions Per Kilometer/Mile, Stabilized August 2012, (“SAE J1025”); IBR approved for § 1037.520(c).

(2) SAE J1252 JUL2012, SAE Wind Tunnel Test Procedure for Trucks and Buses, Revised July 2012, (“SAE J1252”); IBR approved for §§ 1037.525(b); 1037.530(a).

(3) SAE J1263 MAR2010, Road Load Measurement and Dynamometer

Simulation Using Coastdown Techniques, Revised March 2010, (“SAE J1263”); IBR approved for §§ 1037.528 introductory text, (a), (b), (c), (e), and (h); 1037.665(a).

(4) SAE J1594 JUL2010, Vehicle Aerodynamics Terminology, Revised July 2010, (“SAE J1594”); IBR approved for § 1037.530(d).

(5) SAE J2071 REV. JUN94, Aerodynamic Testing of Road Vehicles—Open Throat Wind Tunnel Adjustment, Revised June 1994, (“SAE J2071”); IBR approved for § 1037.530(b).

(6) SAE J2263 MAY2020, (R) Road Load Measurement Using Onboard Anemometry and Coastdown Techniques, Revised May 2020, (“SAE J2263”); IBR approved for §§ 1037.528 introductory text, (a), (b), (d), and (f); 1037.665(a).

(7) SAE J2343 JUL2008, Recommended Practice for LNG Medium and Heavy-Duty Powered Vehicles, Revised July 2008, (“SAE J2343”); IBR approved for § 1037.103(e).

(8) SAE J2452 ISSUED JUN1999, Stepwise Coastdown Methodology for Measuring Tire Rolling Resistance, Issued June 1999, (“SAE J2452”); IBR approved for § 1037.528(h).

(9) SAE J2841 MAR2009, Utility Factor Definitions for Plug-In Hybrid Electric Vehicles Using 2001 U.S. DOT National Household Travel Survey Data, Issued March 2009, (“SAE J2841”); IBR approved for § 1037.550(a).

(10) SAE J2966 SEP2013, Guidelines for Aerodynamic Assessment of Medium and Heavy Commercial Ground Vehicles Using Computational Fluid Dynamics, Issued September 2013, (“SAE J2966”); IBR approved for § 1037.532(a).

(d) U.S. EPA, Office of Air and Radiation, 2565 Plymouth Road, Ann Arbor, MI 48105; [www.epa.gov](http://www.epa.gov).

(1) Greenhouse gas Emissions Model (GEM), Version 2.0.1, September 2012 (“GEM version 2.0.1”); IBR approved for § 1037.520.

(2) Greenhouse gas Emissions Model (GEM) Phase 2, Version 3.0, July 2016 (“GEM Phase 2, Version 3.0”); IBR approved for § 1037.150(bb).

(3) Greenhouse gas Emissions Model (GEM) Phase 2, Version 3.5.1, November 2020 (“GEM Phase 2, Version 3.5.1”); IBR approved for § 1037.150(bb).

(4) Greenhouse gas Emissions Model (GEM) Phase 2, Version 4.0, April 2022 (“GEM Phase 2, Version 4.0”); IBR approved for §§ 1037.150(bb); 1037.520; 1037.550(a).

(5) GEM’s MATLAB/Simulink Hardware-in-Loop model, Version 3.8, December 2020 (“GEM HIL model 3.8”); IBR approved for § 1037.150(bb).

Note 1 to paragraph (d): The computer code for these models is available as noted in the introductory paragraph of this section. A working version of the software is also available for download at [www.epa.gov/regulations-emissions-vehicles-and-engines/greenhouse-gas-emissions-model-gem-medium-and-heavy-duty](http://www.epa.gov/regulations-emissions-vehicles-and-engines/greenhouse-gas-emissions-model-gem-medium-and-heavy-duty).

■ 137. Revise § 1037.815 to read as follows:

**§ 1037.815 Confidential information.**

The provisions of 40 CFR 1068.10 and 1068.11 apply for information you submit under this part.

■ 138. Amend § 1037.825 by revising paragraph (e)(1)(i) to read as follows:

**§ 1037.825 Reporting and recordkeeping requirements.**

\* \* \* \* \*

(e) \* \* \*

(1) \* \* \*

(i) In § 1037.150 we include various reporting and recordkeeping requirements related to interim provisions.

\* \* \* \* \*

**Appendix I to Part 1037 [Redesignated as Appendix A to Part 1037]**

**Appendix II to Part 1037 [Redesignated as Appendix B to Part 1037]**

**Appendix III to Part 1037 [Redesignated as Appendix C to Part 1037]**

**Appendix IV to Part 1037 [Redesignated as Appendix D to Part 1037]**

**Appendix V to Part 1037 [Redesignated as Appendix E to Part 1037]**

■ 139. Redesignate appendices to part 1037 as follows:

Old appendix	New appendix
appendix I to part 1037	appendix A to part 1037.
appendix II to part 1037	appendix B to part 1037.
appendix III to part 1037	appendix C to part 1037.
appendix IV to part 1037	appendix D to part 1037.
appendix V to part 1037	appendix E to part 1037.

**PART 1039—CONTROL OF EMISSIONS FROM NEW AND IN-USE NONROAD COMPRESSION-IGNITION ENGINES**

■ 140. The authority citation for part 1039 continues to read as follows:

**Authority:** 42 U.S.C. 7401-7671q.

■ 141. Amend § 1039.105 by revising the section heading and paragraphs (a) introductory text and (b) introductory text to read as follows:

**§ 1039.105 What smoke opacity standards must my engines meet?**

(a) The smoke opacity standards in this section apply to all engines subject to emission standards under this part, except for the following engines:

\* \* \* \* \*

(b) Measure smoke opacity as specified in § 1039.501(c). Smoke opacity from your engines may not exceed the following standards:

\* \* \* \* \*

■ 142. Amend § 1039.115 by revising paragraphs (e) and (f) to read as follows:

**§ 1039.115 What other requirements apply?**

\* \* \* \* \*

(e) *Adjustable parameters.* Engines that have adjustable parameters must meet all the requirements of this part for any adjustment in the practically adjustable range. We may require that you set adjustable parameters to any specification within the practically adjustable range during any testing, including certification testing, selective enforcement auditing, or in-use testing. General provisions for adjustable parameters apply as specified in 40 CFR 1068.50.

(f) *Prohibited controls.* (1) *General provisions.* You may not design your engines with emission control devices, systems, or elements of design that cause or contribute to an unreasonable risk to public health, welfare, or safety while operating. For example, an engine may not emit a noxious or toxic substance it would otherwise not emit that contributes to such an unreasonable risk.

(2) *Vanadium sublimation in SCR catalysts.* For engines equipped with vanadium-based SCR catalysts, you must design the engine and its emission controls to prevent vanadium sublimation and protect the catalyst from high temperatures. We will evaluate your engine design based on the following information that you must include in your application for certification:

(i) Identify the threshold temperature for vanadium sublimation for your specified SCR catalyst formulation as described in 40 CFR 1065.1113 through 1065.1121.

(ii) Describe how you designed your engine to prevent catalyst inlet temperatures from exceeding the temperature you identify in paragraph (f)(2)(i) of this section, including consideration of engine wear through the useful life. Also describe your design for catalyst protection in case catalyst temperatures exceed the specified temperature. In your

description, include how you considered elevated catalyst temperature resulting from sustained high-load engine operation, catalyst exotherms, DPF regeneration, and component failure resulting in unburned fuel in the exhaust stream.

\* \* \* \* \*

■ 143. Amend § 1039.205 by revising paragraph (s) to read as follows:

**§ 1039.205 What must I include in my application?**

\* \* \* \* \*

(s) Describe all adjustable operating parameters (see § 1039.115(e)), including production tolerances. For any operating parameters that do not qualify as adjustable parameters, include a description supporting your conclusion (see 40 CFR 1068.50(c)). Include the following in your description of each adjustable parameter:

(1) For practically adjustable parameters, include the nominal or recommended setting, the intended practically adjustable range, and the limits or stops used to limit adjustable ranges. State that the limits, stops, or other means of inhibiting adjustment are effective in preventing adjustment of parameters on in-use engines to settings outside your intended practically adjustable ranges.

(2) For programmable operating parameters, state that you have restricted access to electronic controls to prevent parameter adjustments on in-use engines that would allow operation outside the practically adjustable range. Describe how your engines are designed to prevent unauthorized adjustments.

\* \* \* \* \*

■ 144. Amend § 1039.245 by adding paragraph (e) to read as follows:

**§ 1039.245 How do I determine deterioration factors from exhaust durability testing?**

\* \* \* \* \*

(e) You may alternatively determine and verify deterioration factors based on bench-aged aftertreatment as described in 40 CFR 1036.245 and 1036.246, with the following exceptions:

(1) The minimum required aging for engines as specified in 40 CFR 1036.245(c)(2) is 1,500 hours. Operate the engine for service accumulation using the same sequence of duty cycles that would apply for determining a deterioration factor under paragraph (c) of this section.

(2) Use good engineering judgment to perform verification testing using the procedures of § 1039.515 rather than 40 CFR 1036.555. For PEMS testing, measure emissions as the equipment

goes through its normal operation over the course of the day (or shift-day).

(3) Apply infrequent regeneration adjustment factors as specified in § 1039.525 rather than 40 CFR 1036.580.

■ 145. Amend § 1039.501 by revising paragraph (c) to read as follows:

**§ 1039.501 How do I run a valid emission test?**

\* \* \* \* \*

(c) Measure smoke opacity using the procedures in 40 CFR part 1065, subpart L, for evaluating whether engines meet the smoke opacity standards in § 1039.105, except that you may test two-cylinder engines with an exhaust muffler like those installed on in-use engines.

\* \* \* \* \*

■ 146. Revise § 1039.655 to read as follows:

**§ 1039.655 What special provisions apply to engines sold in American Samoa or the Commonwealth of the Northern Mariana Islands?**

(a) The prohibitions in 40 CFR 1068.101(a)(1) do not apply to diesel-fueled engines that are intended for use and will be used in American Samoa or the Commonwealth of the Northern Mariana Islands, subject to the following conditions:

(1) The engine meets the latest applicable emission standards in appendix I of this part.

(2) You meet all the requirements of 40 CFR 1068.265.

(b) If you introduce an engine into U.S. commerce under this section, you must meet the labeling requirements in § 1039.135, but add the following statement instead of the compliance statement in § 1039.135(c)(12):

THIS ENGINE DOES NOT COMPLY WITH U.S. EPA TIER 4 EMISSION REQUIREMENTS. IMPORTING THIS ENGINE INTO THE UNITED STATES OR ANY TERRITORY OF THE UNITED STATES EXCEPT AMERICAN SAMOA OR THE COMMONWEALTH OF THE NORTHERN MARIANA ISLANDS MAY BE A VIOLATION OF FEDERAL LAW SUBJECT TO CIVIL PENALTY.

(c) Introducing into commerce an engine exempted under this section in any state or territory of the United States other than American Samoa or the Commonwealth of the Northern Mariana Islands, throughout its lifetime, violates the prohibitions in 40 CFR 1068.101(a)(1), unless it is exempt under a different provision.

(d) The exemption provisions in this section also applied for engines that were introduced into commerce in Guam before January 1, 2024 if they

would otherwise have been subject to Tier 4 standards.

■ 147. Amend § 1039.801 by revising the definitions of “Adjustable parameter”, “Critical emission-related component”, and “Designated Compliance Officer” to read as follows:

§ 1039.801 What definitions apply to this part?

\* \* \* \* \*

Adjustable parameter has the meaning given in 40 CFR 1068.50.

\* \* \* \* \*

Critical emission-related component has the meaning given in 40 CFR 1068.30.

\* \* \* \* \*

Designated Compliance Officer means the Director, Diesel Engine Compliance Center, U.S. Environmental Protection Agency, 2000 Traverwood Drive, Ann Arbor, MI 48105; complianceinfo@epa.gov; www.epa.gov/ve-certification

Arbor, MI 48105; complianceinfo@epa.gov; www.epa.gov/ve-certification

\* \* \* \* \*

■ 148. Amend appendix I of part 1039 by revising paragraphs (a) and (b) to read as follows:

Appendix I to Part 1039—Summary of Previous Emission Standards

\* \* \* \* \*

(a) Tier 1 standards apply as summarized in the following table:

TABLE 1 TO APPENDIX I—TIER 1 EMISSION STANDARDS [g/kW-hr]

Table with 7 columns: Rated power (kW), Starting model year, NOx, HC, NOx + NMHC, CO, PM. Rows include power ranges from kW < 8 to kW > 560 with corresponding emission values.

(b) Tier 2 standards apply as summarized in the following table:

TABLE 2 TO APPENDIX I—TIER 2 EMISSION STANDARDS [g/kW-hr]

Table with 5 columns: Rated power (kW), Starting model year, NOx + NMHC, CO, PM. Rows include power ranges from kW < 8 to kW > 560 with corresponding emission values.

\* \* \* \* \*

PART 1042—CONTROL OF EMISSIONS FROM NEW AND IN-USE MARINE COMPRESSION-IGNITION ENGINES AND VESSELS

■ 149. The authority citation for part 1042 continues to read as follows:

Authority: 42 U.S.C. 7401–7671q.

Subpart B [Amended]

■ 150. Amend § 1042.110 by revising paragraph (a)(1) to read as follows:

§ 1042.110 Recording reductant use and other diagnostic functions.

(a) \* \* \*

(1) The diagnostic system must monitor reductant supply and alert operators to the need to restore the reductant supply, or to replace the

reductant if it does not meet your concentration specifications. Unless we approve other alerts, use a warning lamp and an audible alarm. You do not need to separately monitor reductant quality if your system uses input from an exhaust NOx sensor (or other sensor) to alert operators when reductant quality is inadequate. However, tank level or DEF flow must be monitored in all cases.

\* \* \* \* \*

■ 151. Amend § 1042.115 by revising paragraphs (d) introductory text and (e) to read as follows:

§ 1042.115 Other requirements.

\* \* \* \* \*

(d) Adjustable parameters. General provisions for adjustable parameters apply as specified in 40 CFR 1068.50.

The following additional category-specific provisions apply:

\* \* \* \* \*

(e) Prohibited controls. (1) General provisions. You may not design your engines with emission control devices, systems, or elements of design that cause or contribute to an unreasonable risk to public health, welfare, or safety while operating. For example, an engine may not emit a noxious or toxic substance it would otherwise not emit that contributes to such an unreasonable risk.

(2) Vanadium sublimation in SCR catalysts. For engines equipped with vanadium-based SCR catalysts, you must design the engine and its emission controls to prevent vanadium sublimation and protect the catalyst from high temperatures. We will evaluate your engine design based on

the following information that you must include in your application for certification:

(i) Identify the threshold temperature for vanadium sublimation for your specified SCR catalyst formulation as described in 40 CFR 1065.1113 through 1065.1121.

(ii) Describe how you designed your engine to prevent catalyst inlet temperatures from exceeding the temperature you identify in paragraph (e)(2)(i) of this section, including consideration of engine wear through the useful life. Also describe your design for catalyst protection in case catalyst temperatures exceed the specified temperature. In your description, include how you considered elevated catalyst temperature resulting from sustained high-load engine operation, catalyst exotherms, DPF regeneration, and component failure resulting in unburned fuel in the exhaust stream.

\* \* \* \* \*

■ 152. Amend § 1042.145 by adding paragraph (h) to read as follows:

**§ 1042.145 Interim provisions.**

\* \* \* \* \*

(h) *Expanded production-line testing.* Production-line testing requirements for Category 1 engine families with a projected U.S.-directed production volume below 100 engines and for all families certified by small-volume engine manufacturers start to apply in model year 2024. All manufacturers must test no more than four engine families in a single model year, and small-volume engine manufacturers must test no more than two engine families in a single model year.

\* \* \* \* \*

■ 153. Amend § 1042.205 by revising paragraphs (c) and (s) to read as follows:

**§ 1042.205 Application requirements.**

\* \* \* \* \*

(c) If your engines are equipped with an engine diagnostic system as required under § 1042.110, explain how it works, describing especially the engine conditions (with the corresponding diagnostic trouble codes) that cause the warning lamp to go on. Also identify the communication protocol (SAE J1939, SAE J1979, etc.).

\* \* \* \* \*

(s) Describe all adjustable operating parameters (see § 1042.115(d)), including production tolerances. For any operating parameters that do not qualify as adjustable parameters, include a description supporting your conclusion (see 40 CFR 1068.50(c)). Include the following in your

description of each adjustable parameter:

(1) For practically adjustable parameters, include the nominal or recommended setting, the intended practically adjustable range, and the limits or stops used to establish adjustable ranges.

(i) For Category 1 engines, state that the limits, stops, or other means of inhibiting mechanical adjustment are effective in preventing adjustment of parameters on in-use engines to settings outside your intended practically adjustable ranges and provide information to support this statement.

(ii) For Category 2 and Category 3 engines, propose a range of mechanical adjustment for each adjustable parameter, as described in § 1042.115(d). State that the limits, stops, or other means of inhibiting mechanical adjustment are effective in preventing adjustment of parameters on in-use engines to settings outside your proposed adjustable ranges and provide information to support this statement.

(2) For programmable operating parameters, state that you have restricted access to electronic controls to prevent parameter adjustments on in-use engines that would allow operation outside the practically adjustable range. Describe how your engines are designed to prevent unauthorized adjustments.

\* \* \* \* \*

■ 154. Amend § 1042.245 by adding paragraph (e) to read as follows:

**§ 1042.245 Deterioration factors.**

\* \* \* \* \*

(e) You may alternatively determine and verify deterioration factors based on bench-aged aftertreatment as described in 40 CFR 1036.245 and 1036.246, with the following exceptions:

(1) The minimum required aging as specified in 40 CFR 1036.245(c)(2) is 1,500 hours for Category 1 engines and 3,000 hours for Category 2 engines.

Operate the engine for service accumulation using the same sequence of duty cycles that would apply for determining a deterioration factor under paragraph (c) of this section.

(2) Use good engineering judgment to perform verification testing using the procedures of § 1042.515 rather than 40 CFR 1036.555. For PEMS testing, measure emissions as the vessel goes through its normal operation over the course of the day (or shift-day).

(3) Apply infrequent regeneration adjustment factors as specified in § 1042.525 rather than 40 CFR 1036.580.

■ 155. Revise § 1042.301 to read as follows:

**§ 1042.301 General provisions.**

(a) If you produce freshly manufactured marine engines that are subject to the requirements of this part, you must test them as described in this subpart.

(b) We may suspend or revoke your certificate of conformity for certain engine families if your production-line engines do not meet the requirements of this part or you do not fulfill your obligations under this subpart (see §§ 1042.325 and 1042.340). Similarly, we may deny applications for certification for the upcoming model year if you do not fulfill your obligations under this subpart (see § 1042.255(c)(1)).

(c) Other regulatory provisions authorize us to suspend, revoke, or void your certificate of conformity, or order recalls for engine families, without regard to whether they have passed production-line testing requirements. The requirements of this subpart do not affect our ability to do selective enforcement audits, as described in 40 CFR part 1068. Individual engines in families that pass production-line testing requirements must also conform to all applicable regulations of this part and 40 CFR part 1068.

(d) You may ask to use another alternate program or measurement method for testing production-line engines. In your request, you must show us that the alternate program gives equal assurance that your engines meet the requirements of this part. We may waive some or all of this subpart's requirements if we approve your alternate program.

(e) If you certify a Category 1 or Category 2 engine family with carryover emission data, as described in § 1042.235(d), you may omit production-line testing if you fulfilled your testing requirements with a related engine family in an earlier year, except as follows:

(1) We may require that you perform additional production-line testing under this subpart in any model year for cause, such as if you file a defect report related to the engine family or if you amend your application for certification in any of the following ways:

(i) You designate a different supplier or change technical specifications for any critical emission-related components.

(ii) You add a new or modified engine configuration such that the test data from the original emission-data engine do not clearly continue to serve as worst-case testing for certification.

(iii) You change your family emission limit without submitting new emission data.

(2) If you certify an engine family with carryover emission data with no production-line testing for more than five model years, we may require that you perform production-line testing again for one of those later model years unless you demonstrate that none of the circumstances identified in paragraph (e)(1) of this section apply for the engine family.

(f) We may ask you to make a reasonable number of production-line engines available for a reasonable time so we can test or inspect them for compliance with the requirements of this part. For Category 3 engines, you are not required to deliver engines to us, but we may inspect and test your engines at any facility at which they are assembled or installed in vessels.

■ 156. Amend § 1042.302 by revising the introductory text to read as follows:

**§ 1042.302 Applicability of this subpart for Category 3 engines.**

If you produce Tier 3 or later Category 3 engines that are subject to the requirements of this part, you must test them as described in this subpart, except as specified in this section.

\* \* \* \* \*

■ 157. Amend § 1042.305 by revising paragraph (a) to read as follows:

**§ 1042.305 Preparing and testing production-line engines.**

\* \* \* \* \*

(a) *Test procedures.* Test your production-line engines using the applicable testing procedures in subpart F of this part to show you meet the duty-cycle emission standards in subpart B of this part. For Category 1 and Category 2 engines, the not-to-exceed standards apply for this testing of Category 1 and Category 2 engines, but you need not do additional testing to show that production-line engines meet the not-to-exceed standards. The mode cap standards apply for testing Category 3 engines subject to Tier 3 standards (or for engines subject to the Annex VI Tier III NOx standards under § 1042.650(d)).

\* \* \* \* \*

■ 158. Revise § 1042.310 to read as follows:

**§ 1042.310 Engine selection for Category 1 and Category 2 engines.**

(a) For Category 1 and Category 2 engine families, the minimum sample size is one engine. You may ask us to approve treating commercial and recreational engines as being from the same engine family for purposes of production-line testing if you certify them using the same emission-data engine.

(b) Select engines for testing as follows:

(1) For Category 1 engines, randomly select one engine within the first 60 days of the start of production for each engine family.

(2) For Category 2 engines, randomly select one engine within 60 days after you produce the fifth engine from an engine family (or from successive families that are related based on your use of carryover data under § 1042.230(d)).

(3) If you do not produce an engine from the engine family in the specified time frame, test the next engine you produce.

(4) Test engines promptly after selecting them. You may preferentially select and test engines earlier than we specify.

(5) You meet the requirement to randomly select engines under this section if you assemble the engine in a way that fully represents your normal production and quality procedures.

(c) For each engine that fails to meet emission standards, select two engines from the same engine family from the next fifteen engines produced or within seven days, whichever is later. If you do not produce fifteen additional engines within 90 days, select two additional engines within 90 days or as soon as practicable. Test engines promptly after selecting them. If an engine fails to meet emission standards for any pollutant, count it as a failing engine under this paragraph (c).

(d) Continue testing until one of the following things happens:

(1) You test the number of engines required under paragraphs (b) and (c) of this section. For example, if the initial engine fails and then two engines pass, testing is complete for that engine family.

(2) The engine family does not comply according to § 1042.315 or you choose to declare that the engine family does not comply with the requirements of this subpart.

(e) You may elect to test more randomly chosen engines than we require under this section.

■ 159. Amend § 1042.315 by revising paragraphs (a)(1) and (b) to read as follows:

**§ 1042.315 Determining compliance.**

\* \* \* \* \*

(a) \* \* \*

**(1) Initial and final test results.**

Calculate and round the test results for each engine. If you do multiple tests on an engine in a given configuration (without modifying the engine), calculate the initial results for each test, then add all the test results together and

divide by the number of tests. Round this final calculated value for the final test results on that engine. Include the Green Engine Factor to determine low-hour emission results, if applicable.

\* \* \* \* \*

(b) For Category 1 and Category 2 engines, if a production-line engine fails to meet emission standards and you test additional engines as described in § 1042.310, calculate the average emission level for each pollutant for all the engines. If the calculated average emission level for any pollutant exceeds the applicable emission standard, the engine family fails the production-line testing requirements of this subpart. Tell us within ten working days if an engine fails. You may request to amend the application for certification to raise the FEL of the engine family as described in § 1042.225(f).

■ 160. Amend § 1042.320 by revising paragraph (c) to read as follows:

**§ 1042.320 What happens if one of my production-line engines fails to meet emission standards?**

\* \* \* \* \*

(c) Use test data from a failing engine for the compliance demonstration under § 1042.315 as follows:

(1) Use the original, failing test results as described in § 1042.315, whether or not you modify the engine or destroy it. However, for catalyst-equipped engines, you may ask us to allow you to exclude an initial failed test if all the following are true:

(i) The catalyst was in a green condition when tested initially.

(ii) The engine met all emission standards when retested after degreening the catalyst.

(iii) No additional emission-related maintenance or repair was performed between the initial failed test and the subsequent passing test.

(2) Do not use test results from a modified engine as final test results under § 1042.315, unless you change your production process for all engines to match the adjustments you made to the failing engine. If you change production processes and use the test results from a modified engine, count the modified engine as the next engine in the sequence, rather than averaging the results with the testing that occurred before modifying the engine.

■ 161. Amend § 1042.325 by revising paragraph (b) to read as follows:

**§ 1042.325 What happens if an engine family fails the production-line testing requirements?**

\* \* \* \* \*

(b) We will tell you in writing if we suspend your certificate in whole or in

part. We will not suspend a certificate until at least 15 days after the engine family fails as described in § 1042.315(b). The suspension is effective when you receive our notice.

\* \* \* \* \*

■ 162. Revise § 1042.345 to read as follows:

**§ 1042.345 Reporting.**

(a) Send us a test report within 45 days after you complete production-line testing for a Category 1 or Category 2 engine family, and within 45 days after you finish testing each Category 3 engine. We may approve a later submission for Category 3 engines if it allows you to combine test reports for multiple engines.

(b) Include the following information in the report:

(1) Describe any facility used to test production-line engines and state its location.

(2) For Category 1 and Category 2 engines, describe how you randomly selected engines.

(3) Describe each test engine, including the engine family's identification and the engine's model year, build date, model number, identification number, and number of hours of operation before testing. Also describe how you developed and applied the Green Engine Factor, if applicable.

(4) Identify how you accumulated hours of operation on the engines and describe the procedure and schedule you used.

(5) Provide the test number; the date, time and duration of testing; test procedure; all initial test results; final test results; and final deteriorated test results for all tests. Provide the emission results for all measured pollutants. Include information for both valid and invalid tests and the reason for any invalidation.

(6) Describe completely and justify any nonroutine adjustment, modification, repair, preparation, maintenance, or test for the test engine if you did not report it separately under this subpart. Include the results of any emission measurements, regardless of the procedure or type of engine.

(c) We may ask you to add information to your written report so we can determine whether your new engines conform with the requirements of this subpart. We may also ask you to send less information.

(d) An authorized representative of your company must sign the following statement:

We submit this report under sections 208 and 213 of the Clean Air Act. Our

production-line testing conformed completely with the requirements of 40 CFR part 1042. We have not changed production processes or quality-control procedures for test engines in a way that might affect emission controls. All the information in this report is true and accurate to the best of my knowledge. I know of the penalties for violating the Clean Air Act and the regulations.

(Authorized Company Representative)

(e) Send electronic reports of production-line testing to the Designated Compliance Officer using an approved information format. If you want to use a different format, send us a written request with justification for a waiver. You may combine reports from multiple engines and engine families into a single report.

(f) We will send copies of your reports to anyone from the public who asks for them. See § 1042.915 for information on how we treat information you consider confidential.

■ 163. Amend § 1042.515 by revising paragraph (d) to read as follows:

**§ 1042.515 Test procedures related to not-exceed standards.**

\* \* \* \* \*

(d) Engine testing may occur at any conditions expected during normal operation but that are outside the conditions described in paragraph (c) of this section, as long as measured values are corrected to be equivalent to the nearest end of the specified range, using good engineering judgment. Correct NO<sub>x</sub> emissions for humidity as specified in 40 CFR part 1065, subpart G.

\* \* \* \* \*

■ 164. Amend § 1042.615 by revising paragraph (g) introductory text to read as follows:

**§ 1042.615 Replacement engine exemption.**

\* \* \* \* \*

(g) In unusual circumstances, you may ask us to allow you to apply the replacement engine exemption of this section for repowering a steamship or a vessel that becomes a "new vessel" under § 1042.901 as a result of modifications, as follows:

\* \* \* \* \*

■ 165. Amend § 1042.660 by revising paragraph (b) to read as follows:

**§ 1042.660 Requirements for vessel manufacturers, owners, and operators.**

\* \* \* \* \*

(b) For vessels equipped with SCR systems requiring the use of urea or other reductants, owners and operators must report to the Designated Compliance Officer within 30 days any

operation of such vessels without the appropriate reductant. For each reportable incident, include the cause of the noncompliant operation, the remedy, and an estimate of the extent of operation without reductant. You must remedy the problem as soon as practicable to avoid violating the tampering prohibition in 40 CFR 1068.101(b)(1). If the remedy is not complete within 30 days of the incident, notify the Designated Compliance Officer when the issue is resolved, along with any relevant additional information related to the repair. This reporting requirement applies for all engines on covered vessels even if the engines are certified to Annex VI standards instead of or in addition to EPA standards under this part. Failure to comply with the reporting requirements of this paragraph (b) is a violation of 40 CFR 1068.101(a)(2). Note that operating such engines without reductant is a violation of 40 CFR 1068.101(b)(1).

\* \* \* \* \*

■ 166. Amend § 1042.901 by revising the definitions of "Adjustable parameter", "Category 1", "Category 2", "Critical emission-related component", and "Designated Compliance Officer" and removing the definition of "Designated Enforcement Officer" to read as follows:

**§ 1042.901 Definitions.**

\* \* \* \* \*

*Adjustable parameter* has the meaning given in 40 CFR 1068.50.

\* \* \* \* \*

*Category 1* means relating to a marine engine with specific engine displacement below 7.0 liters per cylinder. See § 1042.670 to determine equivalent per-cylinder displacement for nonreciprocating marine engines (such as gas turbine engines). Note that the maximum specific engine displacement for Category 1 engines subject to Tier 1 and Tier 2 standards was 5.0 liters per cylinder.

*Category 2* means relating to a marine engine with a specific engine displacement at or above 7.0 liters per cylinder but less than 30.0 liters per cylinder. See § 1042.670 to determine equivalent per-cylinder displacement for nonreciprocating marine engines (such as gas turbine engines). Note that the minimum specific engine displacement for Category 2 engines subject to Tier 1 and Tier 2 standards was 5.0 liters per cylinder.

\* \* \* \* \*



*Critical emission-related component* has the meaning given in 40 CFR 1068.30.

*Designated Compliance Officer* means the Director, Diesel Engine Compliance Center, U.S. Environmental Protection

Agency, 2000 Traverwood Drive, Ann Arbor, MI 48105; *complianceinfo@epa.gov*; *www.epa.gov/ve-certification*.

■ 167. Amend appendix I to part 1042 by revising paragraph (a) to read as follows:

**Appendix I to Part 1042—Summary of Previous Emission Standards**

(a) *Engines below 37 kW*. Tier 1 and Tier 2 standards for engines below 37 kW originally adopted under 40 CFR part 89 apply as follows:

TABLE 1 TO APPENDIX I—EMISSION STANDARDS FOR ENGINES BELOW 37 kW [g/kW-hr]

Rated power (kW)	Tier	Model year	NMHC + NO <sub>x</sub>	CO	PM
kW<8	Tier 1	2000	10.5	8.0	1.0
	Tier 2	2005	7.5	8.0	0.80
8≤kW<19	Tier 1	2000	9.5	6.6	0.80
	Tier 2	2005	7.5	6.6	0.80
19≤kW<37	Tier 1	1999	9.5	5.5	0.80
	Tier 2	2004	7.5	5.5	0.60

**PART 1043—CONTROL OF NO<sub>x</sub>, SO<sub>x</sub>, AND PM EMISSIONS FROM MARINE ENGINES AND VESSELS SUBJECT TO THE MARPOL PROTOCOL**

■ 168. The authority citation for part 1043 continues to read as follows:  
**Authority:** 33 U.S.C. 1901–1912.

■ 169. Amend § 1043.20 by removing the definition of “Public vessels” and adding a definition of “Public vessel” in alphabetical order to read as follows:

**§ 1043.20 Definitions.**

*Public vessel* means a warship, naval auxiliary vessel, or other vessel owned or operated by a sovereign country when engaged in noncommercial service. Vessels with a national security exemption under 40 CFR 1042.635 are deemed to be public vessels with respect to compliance with NO<sub>x</sub>-related requirements of this part when engaged in noncommercial service. Similarly, vessels with one or more installed engines that have a national security exemption under 40 CFR 1090.605 are deemed to be public vessels with respect to compliance with fuel content requirements when engaged in noncommercial service.

■ 170. Amend § 1043.55 by revising paragraphs (a) and (b) to read as follows:

**§ 1043.55 Applying equivalent controls instead of complying with fuel requirements.**

(a) The U.S. Coast Guard is the approving authority under APPS for such equivalent methods for U.S.-flagged vessels.

(b) The provisions of this paragraph (b) apply for vessels equipped with controls certified by the U.S. Coast Guard or the Administration of a foreign-flag vessel to achieve emission levels equivalent to those achieved by the use of fuels meeting the applicable fuel sulfur limits of Regulation 14 of Annex VI. Fuels not meeting the applicable fuel sulfur limits of Regulation 14 of Annex VI may be used on such vessels consistent with the provisions of the IAPP certificate, APPS and Annex VI.

■ 171. Amend § 1043.95 by revising paragraph (b) to read as follows:

**§ 1043.95 Great Lakes provisions.**

(b) The following exemption provisions apply for ships qualifying under paragraph (a) of this section:

(1) The fuel-use requirements of this part do not apply through December 31, 2025, if we approved an exemption under this section before [60 days after the date of publication in the **Federal Register**] based on the use of replacement engines certified to applicable standards under 40 CFR part 1042 corresponding to the date the vessel entered dry dock for service. All other requirements under this part 1043 continue to apply to exempted vessels, including requirements related to bunker delivery notes.

(2) A marine diesel engine installed to repower a steamship may be certified to the Tier II NO<sub>x</sub> standard instead of the Tier III NO<sub>x</sub> standard pursuant to Regulation 13 of Annex VI.

**PART 1045—CONTROL OF EMISSIONS FROM SPARK-IGNITION PROPULSION MARINE ENGINES AND VESSELS**

■ 172. The authority citation for part 1045 continues to read as follows:  
**Authority:** 42 U.S.C. 7401–7671q.

■ 173. Amend § 1045.115 by revising paragraphs (e) and (f) to read as follows:

**§ 1045.115 What other requirements apply?**

(e) *Adjustable parameters*. Engines that have adjustable parameters must meet all the requirements of this part for any adjustment in the practically adjustable range. We may require that you set adjustable parameters to any specification within the practically adjustable range during any testing, including certification testing, production-line testing, or in-use testing. General provisions for adjustable parameters apply as specified in 40 CFR 1068.50.

(f) *Prohibited controls*. You may not design your engines with emission control devices, systems, or elements of design that cause or contribute to an unreasonable risk to public health, welfare, or safety while operating. For example, an engine may not emit a noxious or toxic substance it would otherwise not emit that contributes to such an unreasonable risk.

■ 174. Amend § 1045.205 by revising paragraph (r) to read as follows:

**§ 1045.205 What must I include in my application?**

(r) Describe all adjustable operating parameters (see § 1045.115(e)), including production tolerances. For any operating parameters that do not

qualify as adjustable parameters, include a description supporting your conclusion (see 40 CFR 1068.50(c)). Include the following in your description of each adjustable parameter:

(1) For practically adjustable parameters, include the nominal or recommended setting, the intended practically adjustable range, and the limits or stops used to establish adjustable ranges. State that the limits, stops, or other means of inhibiting adjustment are effective in preventing adjustment of parameters on in-use engines to settings outside your intended practically adjustable ranges and provide information to support this statement.

(2) For programmable operating parameters, state that you have restricted access to electronic controls to prevent parameter adjustments on in-use engines that would allow operation outside the practically adjustable range. Describe how your engines are designed to prevent unauthorized adjustments.

\* \* \* \* \*

■ 175. Amend § 1045.801 by revising the definitions of “Adjustable parameter” and “Critical emission-related component” to read as follows:

**§ 1045.801 What definitions apply to this part?**

\* \* \* \* \*

*Adjustable parameter* has the meaning given in 40 CFR 1068.50.

\* \* \* \* \*

*Critical emission-related component* has the meaning given in 40 CFR 1068.30.

\* \* \* \* \*

■ 176. Revise § 1045.815 to read as follows:

**§ 1045.815 What provisions apply to confidential information?**

The provisions of 40 CFR 1068.10 and 1068.11 apply for information you submit under this part.

**PART 1048—CONTROL OF EMISSIONS FROM NEW, LARGE NONROAD SPARK-IGNITION ENGINES**

■ 177. The authority citation for part 1048 continues to read as follows:

Authority: 42 U.S.C. 7401–7671q.

**Subpart B [Amended]**

■ 178. Amend § 1048.115 by revising paragraphs (e) and (f) to read as follows:

**§ 1048.115 What other requirements apply?**

\* \* \* \* \*

(e) *Adjustable parameters.* Engines that have adjustable parameters must

meet all the requirements of this part for any adjustment in the practically adjustable range. We may require that you set adjustable parameters to any specification within the practically adjustable range during any testing, including certification testing, production-line testing, or in-use testing. General provisions for adjustable parameters apply as specified in 40 CFR 1068.50.

(f) *Prohibited controls.* You may not design your engines with emission control devices, systems, or elements of design that cause or contribute to an unreasonable risk to public health, welfare, or safety while operating. For example, an engine may not emit a noxious or toxic substance it would otherwise not emit that contributes to such an unreasonable risk.

\* \* \* \* \*

■ 179. Amend § 1048.205 by revising paragraph (t) to read as follows:

**§ 1048.205 What must I include in my application?**

\* \* \* \* \*

(t) Describe all adjustable operating parameters (see § 1048.115(e)), including production tolerances. For any operating parameters that do not qualify as adjustable parameters, include a description supporting your conclusion (see 40 CFR 1068.50(c)). Include the following in your description of each adjustable parameter:

(1) For practically adjustable parameters, include the nominal or recommended setting, the intended practically adjustable range, and the limits or stops used to establish adjustable ranges. State that the limits, stops, or other means of inhibiting adjustment are effective in preventing adjustment of parameters on in-use engines to settings outside your intended practically adjustable ranges and provide information to support this statement.

(2) For programmable operating parameters, state that you have restricted access to electronic controls to prevent parameter adjustments on in-use engines that would allow operation outside the practically adjustable range. Describe how your engines are designed to prevent unauthorized adjustments.

\* \* \* \* \*

■ 180. Amend § 1048.240 by adding paragraph (f) to read as follows:

**§ 1048.240 How do I demonstrate that my engine family complies with exhaust emission standards?**

\* \* \* \* \*

(f) You may alternatively determine and verify deterioration factors based on

bench-aged aftertreatment as described in 40 CFR 1036.245 and 1036.246, with the following exceptions:

(1) The minimum required aging for engines as specified in 40 CFR 1036.245(c)(2) is 300 hours. Operate the engine for service accumulation using the same sequence of duty cycles that would apply for determining a deterioration factor under paragraph (c) of this section.

(2) Use good engineering judgment to perform verification testing using the procedures of § 1048.515 rather than 40 CFR 1036.555. For PEMS testing, measure emissions as the equipment goes through its normal operation over the course of the day (or shift-day).

■ 181. Amend § 1048.501 by revising paragraph (e)(2) to read as follows:

**§ 1048.501 How do I run a valid emission test?**

\* \* \* \* \*

(e) \* \* \*

(2) For engines equipped with carbon canisters that store fuel vapors that will be purged for combustion in the engine, precondition the canister as specified in 40 CFR 86.132–96(h) and then operate the engine for 60 minutes over repeat runs of the duty cycle specified in appendix II of this part.

\* \* \* \* \*

■ 182. Amend § 1048.620 by revising paragraphs (a)(3), (d), and (e) to read as follows:

**§ 1048.620 What are the provisions for exempting large engines fueled by natural gas or liquefied petroleum gas?**

(a) \* \* \*

(3) The engine must be in an engine family that has a valid certificate of conformity showing that it meets emission standards for engines of that power rating under 40 CFR part 1039.

\* \* \* \* \*

(d) Engines exempted under this section are subject to all the requirements affecting engines under 40 CFR part 1039. The requirements and restrictions of 40 CFR part 1039 apply to anyone manufacturing engines exempted under this section, anyone manufacturing equipment that uses these engines, and all other persons in the same manner as if these were nonroad diesel engines.

(e) You may request an exemption under this section by submitting an application for certification for the engines under 40 CFR part 1039.

■ 183. Amend § 1048.801 by revising the definitions of “Adjustable parameter” and “Critical emission-related component” to read as follows:

§ 1048.801 What definitions apply to this part?

\* \* \* \* \*

Adjustable parameter has the meaning given in 40 CFR 1068.50.

\* \* \* \* \*

Critical emission-related component has the meaning given in 40 CFR 1068.30.

\* \* \* \* \*

■ 184. Revise § 1048.815 to read as follows:

§ 1048.815 What provisions apply to confidential information?

The provisions of 40 CFR 1068.10 and 1068.11 apply for information you submit under this part.

PART 1051—CONTROL OF EMISSIONS FROM RECREATIONAL ENGINES AND VEHICLES

■ 185. The authority citation for part 1051 continues to read as follows:

Authority: 42 U.S.C. 7401–7671q.

Subpart B [Amended]

■ 186. Amend § 1051.115 by revising paragraphs (c), (d) introductory text, (d)(1), (d)(2) introductory text, and (e) to read as follows:

§ 1051.115 What other requirements apply?

\* \* \* \* \*

(c) Adjustable parameters. Vehicles that have adjustable parameters must meet all the requirements of this part for any adjustment in the practically adjustable range. Note that parameters that control the air-fuel ratio may be treated separately under paragraph (d) of this section. We may require that you set adjustable parameters to any specification within the practically adjustable range during any testing, including certification testing, production-line testing, or in-use testing. General provisions for adjustable parameters apply as specified in 40 CFR 1068.50.

(d) Other adjustments. The following provisions apply for engines with carburetor jets or needles, and for engines with any other technology involving service to adjust air-fuel ratio that falls within the time and cost specifications of 40 CFR 1068.50(d)(1):

(1) In your application for certification, specify the practically adjustable range of air-fuel ratios you expect to occur in use. You may specify it in terms of engine parts (such as the carburetor jet size and needle configuration as a function of atmospheric conditions).

(2) The practically adjustable range specified in paragraph (d)(1) of this

section must include all air-fuel ratios between the lean limit and the rich limit, unless you can show that some air-fuel ratios will not occur in use.

\* \* \* \* \*

(e) Prohibited controls. You may not design your engines with emission control devices, systems, or elements of design that cause or contribute to an unreasonable risk to public health, welfare, or safety while operating. For example, an engine may not emit a noxious or toxic substance it would otherwise not emit that contributes to such an unreasonable risk.

\* \* \* \* \*

■ 187. Amend § 1051.205 by revising paragraph (q) to read as follows:

§ 1051.205 What must I include in my application?

\* \* \* \* \*

(q) Describe all adjustable operating parameters (see § 1051.115(e)), including production tolerances. For any operating parameters that do not qualify as adjustable parameters, include a description supporting your conclusion (see 40 CFR 1068.50(c)). Include the following in your description of each adjustable parameter:

(1) For practically adjustable parameters, include the nominal or recommended setting, the intended practically adjustable range, and the limits or stops used to establish adjustable ranges. State that the limits, stops, or other means of inhibiting adjustment are effective in preventing adjustment of parameters on in-use engines to settings outside your intended practically adjustable ranges and provide information to support this statement.

(2) For programmable operating parameters, state that you have restricted access to electronic controls to prevent parameter adjustments on in-use engines that would allow operation outside the practically adjustable range. Describe how your engines are designed to prevent unauthorized adjustments.

\* \* \* \* \*

■ 188. Amend § 1051.501 by revising paragraphs (c)(2), (d)(2)(i) and (d)(3) to read as follows:

§ 1051.501 What procedures must I use to test my vehicles or engines?

\* \* \* \* \*

(c) \* \* \*

(2) To measure fuel-line permeation emissions, use the equipment and procedures specified in SAE J30 as described in 40 CFR 1060.810. Prior to permeation testing, precondition the fuel line by filling it with the fuel

specified in paragraph (d)(3) of this section, sealing the openings, and soaking it for 4 weeks at (23 ±5) °C. Use the fuel specified in paragraph (d)(3) of this section. Perform daily measurements for 14 days, except that you may omit up to two daily measurements in any seven-day period. Maintain an ambient temperature of (23 ±2) °C throughout the sampling period, except for intervals up to 30 minutes for weight measurements.

(d) \* \* \*

(2) \* \* \*

(i) For the preconditioning soak described in § 1051.515(a)(1) and fuel slosh durability test described in § 1051.515(d)(3), use the fuel specified in 40 CFR 1065.710(b), or the fuel specified in 40 CFR 1065.710(c) blended with 10 percent ethanol by volume. As an alternative, you may use Fuel CE10, which is Fuel C as specified in ASTM D471 (see 40 CFR 1060.810) blended with 10 percent ethanol by volume.

\* \* \* \* \*

(3) Fuel hose permeation. Use the fuel specified in 40 CFR 1065.710(b), or the fuel specified in 40 CFR 1065.710(c) blended with 10 percent ethanol by volume for permeation testing of fuel lines. As an alternative, you may use Fuel CE10, which is Fuel C as specified in ASTM D471 (see 40 CFR 1060.810) blended with 10 percent ethanol by volume.

\* \* \* \* \*

■ 189. Amend § 1051.515 by revising paragraph (a)(1) to read as follows:

§ 1051.515 How do I test my fuel tank for permeation emissions?

\* \* \* \* \*

(a) \* \* \*

(1) Fill the tank with the fuel specified in § 1051.501(d)(2)(i), seal it, and allow it to soak at 28 ±5 °C for 20 weeks or at (43 ±5) °C for 10 weeks.

\* \* \* \* \*

■ 190. Amend § 1051.740 by revising paragraph (b)(5) to read as follows:

§ 1051.740 Are there special averaging provisions for snowmobiles?

\* \* \* \* \*

(b) \* \* \*

(5) Credits can also be calculated for Phase 3 using both sets of standards. Without regard to the trigger level values, if your net emission reduction for the redesignated averaging set exceeds the requirements of Phase 3 in § 1051.103 (using both HC and CO in the Phase 3 equation in § 1051.103), then your credits are the difference between the Phase 3 reduction requirement of that section and your calculated value.

■ 191. Amend § 1051.801 by revising the definitions of “Adjustable parameter” and “Critical emission-related component” to read as follows:

**§ 1051.801 What definitions apply to this part?**

\* \* \* \* \*

*Adjustable parameter* has the meaning given in 40 CFR 1068.50.

\* \* \* \* \*

*Critical emission-related component* has the meaning given in 40 CFR 1068.30.

\* \* \* \* \*

■ 192. Revise § 1051.815 to read as follows:

**§ 1051.815 What provisions apply to confidential information?**

The provisions of 40 CFR 1068.10 and 1068.11 apply for information you submit under this part.

**PART 1054—CONTROL OF EMISSIONS FROM NEW, SMALL NONROAD SPARK-IGNITION ENGINES AND EQUIPMENT**

■ 193. The authority citation for part 1054 continues to read as follows:

**Authority:** 42 U.S.C. 7401–7671q.

■ 194. Amend § 1054.115 by revising paragraphs (b) and (d) to read as follows:

**§ 1054.115 What other requirements apply?**

\* \* \* \* \*

(b) *Adjustable parameters.* Engines that have adjustable parameters must meet all the requirements of this part for any adjustment in the practically adjustable range. We may require that you set adjustable parameters to any specification within the practically adjustable range during any testing, including certification testing, production-line testing, or in-use testing. You may ask us to limit idle-speed or carburetor adjustments to a smaller range than the practically adjustable range if you show us that the engine will not be adjusted outside of this smaller range during in-use operation without significantly degrading engine performance. General provisions for adjustable parameters apply as specified in 40 CFR 1068.50.

\* \* \* \* \*

(d) *Prohibited controls.* You may not design your engines with emission control devices, systems, or elements of design that cause or contribute to an unreasonable risk to public health, welfare, or safety while operating. For example, an engine may not emit a noxious or toxic substance it would

otherwise not emit that contributes to such an unreasonable risk.

\* \* \* \* \*

■ 195. Amend § 1054.205 by revising paragraphs (o)(1) and (q) to read as follows:

**§ 1054.205 What must I include in my application?**

\* \* \* \* \*

(o) \* \* \*

(1) Present emission data for hydrocarbon (such as THC, THCE, or NMHC, as applicable), NO<sub>x</sub>, and CO on an emission-data engine to show your engines meet the applicable exhaust emission standards as specified in § 1054.101. Show emission figures before and after applying deterioration factors for each engine. Include test data from each applicable duty cycle as specified in § 1054.505(b). If we specify more than one grade of any fuel type (for example, low-temperature and all-season gasoline), you need to submit test data only for one grade, unless the regulations of this part specify otherwise for your engine.

\* \* \* \* \*

(q) Describe all adjustable operating parameters (see § 1054.115(b)), including production tolerances. For any operating parameters that do not qualify as adjustable parameters, include a description supporting your conclusion (see 40 CFR 1068.50(c)). Include the following in your description of each adjustable parameter:

(1) For practically adjustable parameters, include the nominal or recommended setting, the intended practically adjustable range, and the limits or stops used to establish adjustable ranges. State that the limits, stops, or other means of inhibiting adjustment are effective in preventing adjustment of parameters on in-use engines to settings outside your intended practically adjustable ranges and provide information to support this statement.

(2) For programmable operating parameters, state that you have restricted access to electronic controls to prevent parameter adjustments on in-use engines that would allow operation outside the practically adjustable range. Describe how your engines are designed to prevent unauthorized adjustments.

\* \* \* \* \*

■ 196. Amend § 1054.230 by revising paragraphs (b)(8) and (9) to read as follows:

**§ 1054.230 How do I select emission families?**

\* \* \* \* \*

(b) \* \* \*

(8) Method of control for engine operation, other than governing. For example, multi-cylinder engines with port fuel injection may not be grouped into an emission family with engines that have a single throttle-body injector or carburetor.

(9) The numerical level of the applicable emission standards. For example, an emission family may not include engines certified to different family emission limits, though you may change family emission limits without recertifying as specified in § 1054.225.

\* \* \* \* \*

■ 197. Amend § 1054.505 by revising paragraphs (a), (b) introductory text, (b)(1)(i), (b)(2), and (d)(1) to read as follows:

**§ 1054.505 How do I test engines?**

(a) This section describes how to test engines under steady-state conditions. We may also perform other testing as allowed by the Clean Air Act. Sample emissions separately for each mode, then calculate an average emission level for the whole cycle using the weighting factors specified for each mode. Control engine speed as specified in this section. Use one of the following methods for confirming torque values for nonhandheld engines:

(1) Calculate torque-related cycle statistics and compare with the established criteria as specified in 40 CFR 1065.514 to confirm that the test is valid.

(2) Evaluate each mode separately to validate the duty cycle. All torque feedback values recorded during non-idle sampling periods must be within ±2 percent of the reference value or within ±0.27 N·m of the reference value, whichever is greater. Also, the mean torque value during non-idle sampling periods must be within ±1 percent of the reference value or ±0.12 N·m of the reference value, whichever is greater. Control torque during idle as specified in paragraph (c) of this section.

(b) Measure emissions by testing engines on a dynamometer with the test procedures for constant-speed engines in 40 CFR part 1065 while using the steady-state duty cycles identified in this paragraph (b) to determine whether it meets the exhaust emission standards specified in § 1054.101(a). This paragraph (b) applies for all engines, including those not meeting the definition of “constant-speed engine” in 40 CFR 1065.1001.

(1) \* \* \*

(i) For ungoverned handheld engines used in fixed-speed applications all having approximately the same nominal

in-use operating speed, hold engine speed within 350 rpm of the nominal speed for testing. We may allow you to include in your engine family, without additional testing, a small number of engines that will be installed such that they have a different nominal speed. If your engine family includes a majority of engines with approximately the same nominal in-use operating speed and a substantial number of engines with different nominal speeds, you must test engines as specified in this paragraph (b)(1)(i) and paragraph (b)(1)(ii) of this section.

(2) For nonhandheld engines designed to idle, use the six-mode duty cycle described in paragraph (b)(1) of appendix II of this part; use the five-mode duty cycle described in paragraph (b)(2) of appendix II of this part for engines that are not designed to idle. If an engine family includes engines designed to idle and engines not designed to idle, include in the application for certification the test results for the duty cycle that will result in worst-case HC+NO<sub>x</sub> emissions based on measured values for that engine family. Control engine speed during the full-load operating mode as specified in paragraph (d) of this section. For all other modes, control engine speed to within 5 percent of the nominal speed specified in paragraph (d) of this section or let the installed governor (in the production configuration) control engine speed. For all modes except idle, control torque as needed to meet the cycle-validation criteria in paragraph (a) of this section. The governor may be adjusted before emission sampling to target the nominal speed identified in paragraph (d) of this section, but the installed governor must control engine speed throughout the emission-sampling period whether the governor is adjusted or not.

(d) (1) Select an engine speed for testing as follows:

(i) For engines with a governed speed at full load between 2700 and 4000 rpm,

select appropriate test speeds for the emission family. If all the engines in the emission family are used in intermediate-speed equipment, select a test speed of 3060 rpm. The test associated with intermediate-speed operation is referred to as the A Cycle. If all the engines in the emission family are used in rated-speed equipment, select a test speed of 3600 rpm. The test associated with rated-speed operation is referred to as the B Cycle. If an emission family includes engines used in both intermediate-speed equipment and rated-speed equipment, measure emissions at test speeds of both 3060 and 3600 rpm. In unusual circumstances, you may ask to use a test speed different than that specified in this paragraph (d)(1)(i) if it better represents in-use operation.

(ii) For engines with a governed speed below 2700 or above 4000 rpm, ask us to approve one or more test speeds to represent those engines using the provisions for special procedures in 40 CFR 1065.10(c)(2).

- 198. Amend § 1054.801 by:
a. Revising the definitions of "Adjustable parameter" and "Critical emission-related component".
b. Removing the definition of "Discrete mode".
c. Revising the definition of "Intermediate-speed equipment".
d. Removing the definition of "Ramped-modal".
e. Revising the definitions of "Rated-speed equipment" and "Steady-state".

The revisions read as follows:
§ 1054.801 What definitions apply to this part?

Adjustable parameter has the meaning given in 40 CFR 1068.50.

Critical emission-related component has the meaning given in 40 CFR 1068.30.

Intermediate-speed equipment includes all nonhandheld equipment in which the installed engine's governed

speed at full load is below 3330 rpm. It may also include nonhandheld equipment in which the installed engine's governed speed at full load is as high as 3400 rpm.

\* \* \* \* \*

Rated-speed equipment includes all nonhandheld equipment in which the installed engine's governed speed at full load is at or above 3400 rpm. It may also include nonhandheld equipment in which the installed engine's governed speed at full load is as low as 3330 rpm.

\* \* \* \* \*

Steady-state means relating to emission tests in which engine speed and load are held at a finite set of essentially constant values.

\* \* \* \* \*

199. Revise § 1054.815 to read as follows:

§ 1054.815 What provisions apply to confidential information?

The provisions of 40 CFR 1068.10 and 1068.11 apply for information you submit under this part.

200. Redesignate appendix I to part 1054 as appendix A to part 1054 and amend newly redesignated appendix A by revising paragraph (b)(3) introductory text to read as follows:

Appendix A to Part 1054—Summary of Previous Emission Standards

\* \* \* \* \*

(b) \* \* \*

(3) Note that engines subject to Phase 1 standards were not subject to useful life, deterioration factor, production-line testing, or in-use testing provisions. In addition, engines subject to Phase 1 standards and engines subject to Phase 2 standards were both not subject to the following provisions:

\* \* \* \* \*

201. Redesignate appendix II to part 1054 as appendix B to part 1054 and revise newly redesignated appendix B to read as follows:

Appendix B to Part 1054—Duty Cycles for Laboratory Testing

(a) Test handheld engines with the following steady-state duty cycle:

TABLE 1 TO APPENDIX B—DUTY CYCLE FOR HANDHELD ENGINES

Table with 4 columns: G3 mode No., Engine speed, Torque (percent), and Weighting factors. Row 1: Rated speed, 100, 0.85. Row 2: Warm idle, 0, 0.15.

a Test engines at the specified speeds as described in § 1054.505.
b Test engines at 100 percent torque by setting operator demand to maximum. Control torque during idle at its warm idle speed as described in 40 CFR 1065.510.

(b) Test nonhandheld engines with one of the following steady-state duty cycles:

(1) The following duty cycle applies for engines designed to idle:

TABLE 2 TO APPENDIX B—DUTY CYCLE FOR NONHANDHELD ENGINES WITH IDLE

G2 Mode No. <sup>a</sup>	Torque (percent) <sup>b</sup>	Weighting factors
1 .....	100	0.09
2 .....	75	0.20
3 .....	50	0.29
4 .....	25	0.30
5 .....	10	0.07
6 .....	0	0.05

<sup>a</sup>Control engine speed as described in § 1054.505. Control engine speed for Mode 6 as described in § 1054.505(c) for idle operation.

<sup>b</sup>The percent torque is relative to the value established for full-load torque, as described in § 1054.505.

(2) The following duty cycle applies for engines that are not designed to idle:

TABLE 3 TO APPENDIX B—DUTY CYCLE FOR NONHANDHELD ENGINES WITHOUT IDLE

Mode No. <sup>a</sup>	Torque (percent) <sup>b</sup>	Weighting factors
1 .....	100	0.09
2 .....	75	0.21
3 .....	50	0.31
4 .....	25	0.32
5 .....	10	0.07

<sup>a</sup>Control engine speed as described in § 1054.505.

<sup>b</sup>The percent torque is relative to the value established for full-load torque, as described in § 1054.505.

**PART 1060—CONTROL OF EVAPORATIVE EMISSIONS FROM NEW AND IN-USE NONROAD AND STATIONARY EQUIPMENT**

■ 202. The authority citation for part 1060 continues to read as follows:

**Authority:** 42 U.S.C. 7401–7671q.

■ 203. Amend § 1060.101 by revising paragraph (e)(1) to read as follows:

**§ 1060.101 What evaporative emission requirements apply under this part?**

\* \* \* \* \*

(e) \* \* \*

(1) *Adjustable parameters.*

Components or equipment with adjustable parameters must meet all the requirements of this part for any adjustment in the practically adjustable range. See 40 CFR 1068.50.

\* \* \* \* \*

■ 204. Amend § 1060.515 by revising paragraphs (c) and (d) to read as follows:

**§ 1060.515 How do I test EPA Nonroad Fuel Lines and EPA Cold-Weather Fuel Lines for permeation emissions?**

\* \* \* \* \*

(c) Except as specified in paragraph (d) of this section, measure fuel line permeation emissions using the equipment and procedures for weight-loss testing specified in SAE J30 or SAE J1527 (incorporated by reference in § 1060.810). Start the measurement procedure within 8 hours after draining and refilling the fuel line. Perform the emission test over a sampling period of 14 days. You may omit up to two daily measurements in any seven-day period. Determine your final emission result based on the average of measured values over the 14-day period. Maintain an ambient temperature of (23±2) °C throughout the sampling period, except for intervals up to 30 minutes for daily weight measurements.

(d) For fuel lines with a nominal inner diameter below 5.0 mm, you may alternatively measure fuel line permeation emissions using the equipment and procedures for weight-loss testing specified in SAE J2996 (incorporated by reference in § 1060.810). Determine your final emission result based on the average of measured values over the 14-day sampling period. Maintain an ambient temperature of (23±2) °C throughout the sampling period, except for intervals up to 30 minutes for daily weight measurements.

\* \* \* \* \*

■ 205. Amend § 1060.520 by revising paragraph (b)(1) to read as follows:

**§ 1060.520 How do I test fuel tanks for permeation emissions?**

\* \* \* \* \*

(b) \* \* \*

(1) Fill the fuel tank to its nominal capacity with the fuel specified in paragraph (e) of this section, seal it, and allow it to soak at (28±5) °C for at least 20 weeks. Alternatively, the fuel tank may be soaked for at least 10 weeks at (43±5) °C. You may count the time of the preconditioning steps in paragraph (a) of this section as part of the preconditioning fuel soak as long as the ambient temperature remains within the specified temperature range and the fuel tank continues to be at least 40 percent full throughout the test; you may add or replace fuel as needed to conduct the specified durability procedures. Void the test if you determine that the fuel tank has any kind of leak.

\* \* \* \* \*

■ 206. Amend § 1060.801 by revising the definition of “Adjustable parameter” to read as follows:

**§ 1060.801 What definitions apply to this part?**

\* \* \* \* \*

*Adjustable parameter* has the meaning given in 40 CFR 1068.50.

\* \* \* \* \*

**PART 1065—ENGINE-TESTING PROCEDURES**

■ 207. The authority citation for part 1065 continues to read as follows:

**Authority:** 42 U.S.C. 7401–7671q.

■ 208. Amend § 1065.1 by revising paragraphs (a)(1) through (5) and (8) and adding paragraph (i) to read as follows:

**§ 1065.1 Applicability.**

(a) \* \* \*

(1) Locomotives we regulate under 40 CFR part 1033.

(2) Heavy-duty highway engines we regulate under 40 CFR parts 86 and 1036.

(3) Nonroad compression-ignition engines we regulate under 40 CFR part 1039 and stationary diesel engines that are certified to the standards in 40 CFR part 1039 as specified in 40 CFR part 60, subpart IIII.

(4) Marine compression-ignition engines we regulate under 40 CFR part 1042.

(5) Marine spark-ignition engines we regulate under 40 CFR part 1045.

\* \* \* \* \*

(8) Small nonroad spark-ignition engines we regulate under 40 CFR part 1054 and stationary engines that are certified to the standards in 40 CFR part 1054 as specified in 40 CFR part 60, subpart JJJJ.

\* \* \* \* \*

(i) The following additional procedures apply as described in subpart L of this part:

(1) Measuring brake-specific emissions of semi-volatile organic compounds, which are not subject to separate emission standards.

(2) Identifying the threshold temperature for vanadium sublimation for SCR catalysts.

(3) Measuring the smoke opacity of engine exhaust.

(4) Aging aftertreatment devices in support of determining deterioration factors for certified compression-ignition engines.

■ 209. Amend § 1065.5 by revising paragraphs (a) introductory text and (c) to read as follows:

**§ 1065.5 Overview of this part 1065 and its relationship to the standard-setting part.**

(a) This part specifies procedures that apply generally to measuring brake-specific emissions from various

categories of engines. See subpart L of this part for measurement procedures for testing related to standards other than brake-specific emission standards. See the standard-setting part for directions in applying specific

provisions in this part for a particular type of engine. Before using this part's procedures, read the standard-setting part to answer at least the following questions:

\* \* \* \* \*

(c) The following table shows how this part divides testing specifications into subparts:

TABLE 1 OF § 1065.5—DESCRIPTION OF PART 1065 SUBPARTS

This subpart	Describes these specifications or procedures
Subpart A .....	Applicability and general provisions.
Subpart B .....	Equipment for testing.
Subpart C .....	Measurement instruments for testing.
Subpart D .....	Calibration and performance verifications for measurement systems.
Subpart E .....	How to prepare engines for testing, including service accumulation.
Subpart F .....	How to run an emission test over a predetermined duty cycle.
Subpart G .....	Test procedure calculations.
Subpart H .....	Fuels, engine fluids, analytical gases, and other calibration standards.
Subpart I .....	Special procedures related to oxygenated fuels.
Subpart J .....	How to test with portable emission measurement systems (PEMS).
Subpart L .....	How to test for unregulated and special pollutants and to perform additional measurements related to certification.

■ 210. Amend § 1065.10 by revising paragraph (c)(7)(ii) to read as follows:

**§ 1065.10 Other procedures.**

\* \* \* \* \*

(c) \* \* \*

(7) \* \* \*

(ii) *Submission.* Submit requests in writing to the EPA Program Officer.

\* \* \* \* \*

■ 211. Amend § 1065.12 by revising paragraph (a) to read as follows:

**§ 1065.12 Approval of alternate procedures.**

(a) To get approval for an alternate procedure under § 1065.10(c), send the EPA Program Officer an initial written request describing the alternate procedure and why you believe it is equivalent to the specified procedure. Anyone may request alternate procedure approval. This means that an individual engine manufacturer may request to use an alternate procedure. This also means that an instrument manufacturer may request to have an instrument, equipment, or procedure approved as an alternate procedure to those specified in this part. We may approve your request based on this information alone, whether or not it includes all the information specified in this section. Where we determine that your original submission does not include enough information for us to determine that the alternate procedure is equivalent to the specified procedure, we may ask you to submit supplemental information showing that your alternate procedure is consistently and reliably at least as accurate and repeatable as the specified procedure.

\* \* \* \* \*

■ 212. Amend § 1065.140 by revising paragraph (b)(2) introductory text, (c)(2), (c)(6) introductory text, and (e)(4) to read as follows:

**§ 1065.140 Dilution for gaseous and PM constituents.**

\* \* \* \* \*

(b) \* \* \*

(2) Measure these background concentrations the same way you measure diluted exhaust constituents, or measure them in a way that does not affect your ability to demonstrate compliance with the applicable standards in this chapter. For example, you may use the following simplifications for background sampling:

\* \* \* \* \*

(c) \* \* \*

(2) *Pressure control.* Maintain static pressure at the location where raw exhaust is introduced into the tunnel within ±1.2 kPa of atmospheric pressure. You may use a booster blower to control this pressure. If you test using more careful pressure control and you show by engineering analysis or by test data that you require this level of control to demonstrate compliance at the applicable standards in this chapter, we will maintain the same level of static pressure control when we test.

\* \* \* \* \*

(6) *Aqueous condensation.* You must address aqueous condensation in the CVS as described in this paragraph (c)(6). You may meet these requirements by preventing or limiting aqueous condensation in the CVS from the exhaust inlet to the last emission sample probe. See paragraph (c)(6)(2)(B) of this section for provisions related to the CVS between the last emission sample probe

and the CVS flow meter. You may heat and/or insulate the dilution tunnel walls, as well as the bulk stream tubing downstream of the tunnel to prevent or limit aqueous condensation. Where we allow aqueous condensation to occur, use good engineering judgment to ensure that the condensation does not affect your ability to demonstrate that your engines comply with the applicable standards in this chapter (see § 1065.10(a)).

\* \* \* \* \*

(e) \* \* \*

(4) Control sample temperature to a (47 ±5) °C tolerance, as measured anywhere within 20 cm upstream or downstream of the PM storage media (such as a filter). You may instead measure sample temperature up to 30 cm upstream of the filter or other PM storage media if it is housed within a chamber with temperature controlled to stay within the specified temperature range. Measure sample temperature with a bare-wire junction thermocouple with wires that are (0.500 ±0.025) mm diameter, or with another suitable instrument that has equivalent performance.

■ 213. Amend § 1065.145 by revising paragraph (b)(2) to read as follows:

**§ 1065.145 Gaseous and PM probes, transfer lines, and sampling system components.**

\* \* \* \* \*

(b) \* \* \*

(2) Sample and measure emissions from each stack and calculate emissions separately for each stack. Add the mass (or mass rate) emissions from each stack to calculate the emissions from the entire engine. Testing under this paragraph (b)(2) requires measuring or

calculating the exhaust molar flow for each stack separately. If the exhaust molar flow in each stack cannot be calculated from intake air flow(s), fuel flow(s), and measured gaseous emissions, and it is impractical to measure the exhaust molar flows directly, you may alternatively proportion the engine's calculated total exhaust molar flow rate (where the flow is calculated using intake air mass flow(s), fuel mass flow(s), and emissions concentrations) based on exhaust molar flow measurements in each stack using a less accurate, non-traceable method. For example, you may use a total pressure probe and static pressure measurement in each stack.

\* \* \* \* \*

- 214. Amend § 1065.170 by revising paragraphs (a)(1) and (c)(1)(ii) and (iii) to read as follows:

**§ 1065.170 Batch sampling for gaseous and PM constituents.**

\* \* \* \* \*

(a) \* \* \*

(1) Verify proportional sampling after an emission test as described in § 1065.545. You must exclude from the proportional sampling verification any portion of the test where you are not sampling emissions because the engine is turned off and the batch samplers are not sampling, accounting for exhaust transport delay in the sampling system. Use good engineering judgment to select storage media that will not significantly change measured emission levels (either up or down). For example, do not use sample bags for storing emissions if the bags are permeable with respect to emissions or if they off gas emissions to the extent that it affects your ability to demonstrate compliance with the applicable gaseous emission standards in this chapter. As another example, do not use PM filters that irreversibly absorb or adsorb gases to the extent that it affects your ability to demonstrate

compliance with the applicable PM emission standards in this chapter.

\* \* \* \* \*

(c) \* \* \*

(1) \* \* \*

(ii) The filter must be circular, with an overall diameter of  $(46.50 \pm 0.60)$  mm and an exposed diameter of at least 38 mm. See the cassette specifications in paragraph (c)(1)(vii) of this section.

(iii) We highly recommend that you use a pure PTFE filter material that does not have any flow-through support bonded to the back and has an overall thickness of  $(40 \pm 20)$   $\mu$ m. An inert polymer ring may be bonded to the periphery of the filter material for support and for sealing between the filter cassette parts. We consider Polymethylpentene (PMP) and PTFE inert materials for a support ring, but other inert materials may be used. See the cassette specifications in paragraph (c)(1)(vii) of this section. We allow the use of PTFE-coated glass fiber filter material, as long as this filter media selection does not affect your ability to demonstrate compliance with the applicable standards in this chapter, which we base on a pure PTFE filter material. Note that we will use pure PTFE filter material for compliance testing, and we may require you to use pure PTFE filter material for any compliance testing we require, such as for selective enforcement audits.

\* \* \* \* \*

**§ 1065.190 [Amended]**

- 215. Amend § 1065.190 by removing paragraphs (g)(5) and (6).

- 216. Amend § 1065.210 by revising paragraph (a) to read as follows:

**§ 1065.210 Work input and output sensors.**

(a) *Application.* Use instruments as specified in this section to measure work inputs and outputs during engine operation. We recommend that you use sensors, transducers, and meters that meet the specifications in Table 1 of

§ 1065.205. Note that your overall systems for measuring work inputs and outputs must meet the linearity verifications in § 1065.307. We recommend that you measure work inputs and outputs where they cross the system boundary as shown in Figure 1 of this section. The system boundary is different for air-cooled engines than for liquid-cooled engines. If you choose to measure work before or after a work conversion, relative to the system boundary, use good engineering judgment to estimate any work-conversion losses in a way that avoids overestimation of total work. For example, if it is impractical to instrument the shaft of an exhaust turbine generating electrical work, you may decide to measure its converted electrical work. As another example, you may decide to measure the tractive (*i.e.*, electrical output) power of a locomotive, rather than the brake power of the locomotive engine. In these cases, divide the electrical work by accurate values of electrical generator efficiency ( $\eta < 1$ ), or assume an efficiency of 1 ( $\eta = 1$ ), which would over-estimate brake-specific emissions. For the example of using locomotive tractive power with a generator efficiency of 1 ( $\eta = 1$ ), this means using the tractive power as the brake power in emission calculations. Do not underestimate any work conversion efficiencies for any components outside the system boundary that do not return work into the system boundary. And do not overestimate any work conversion efficiencies for components outside the system boundary that do return work into the system boundary. In all cases, ensure that you are able to accurately demonstrate compliance with the applicable standards in this chapter. Figure 1 follows:

**Figure 1 to Paragraph (a) of § 1065.210: Work Inputs, Outputs, and System Boundaries**



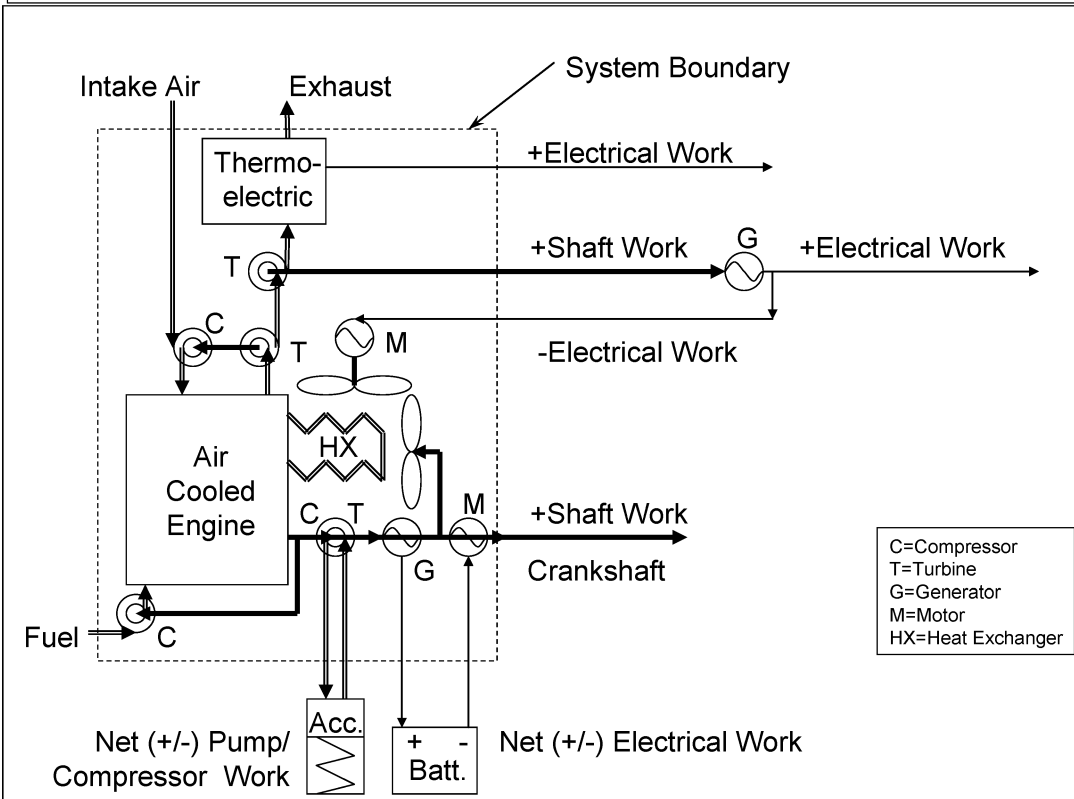
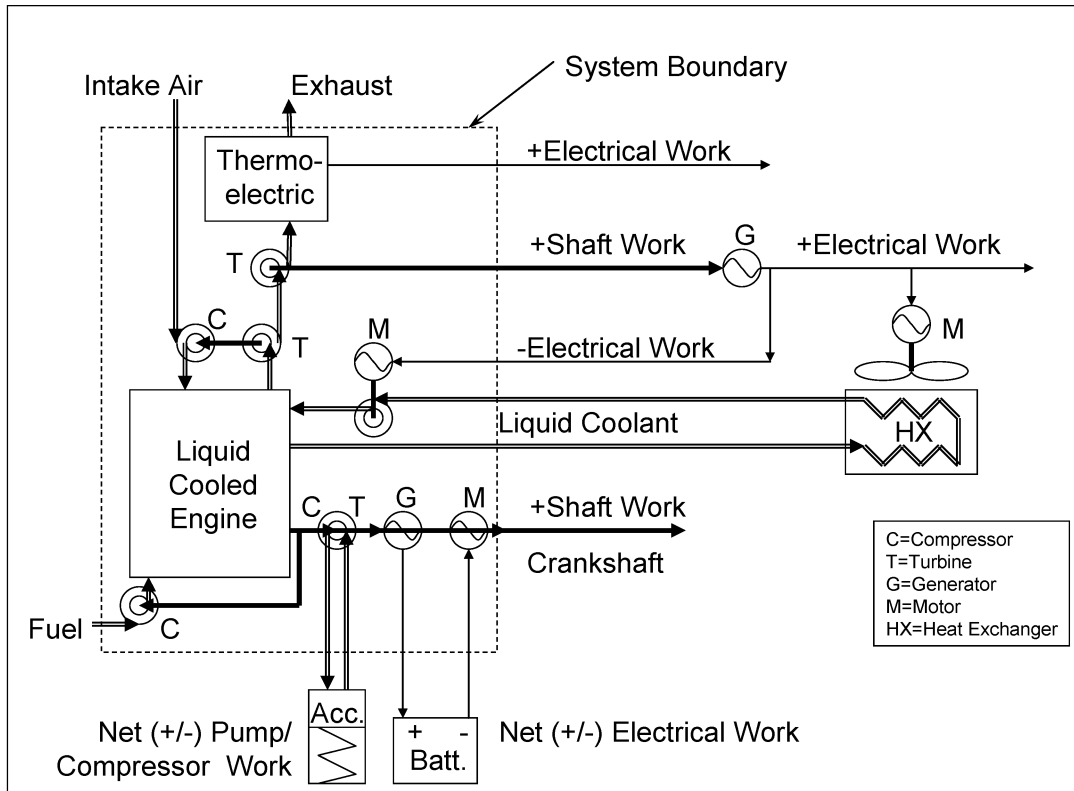

\* \* \* \* \*

■ 217. Amend § 1065.260 by revising paragraph (a) to read as follows:

§ 1065.260 Flame-ionization detector.

(a) *Application.* Use a flame-ionization detector (FID) analyzer to measure hydrocarbon concentrations in raw or diluted exhaust for either batch or continuous sampling. Determine

hydrocarbon concentrations on a carbon number basis of one, C<sub>1</sub>. For measuring THC or THCE you must use a FID analyzer. For measuring CH<sub>4</sub> you must meet the requirements of paragraph (g) of this section. See subpart I of this part

for special provisions that apply to measuring hydrocarbons when testing with oxygenated fuels.

\* \* \* \* \*

■ 218. Add § 1065.274 under undesignated center heading “NO<sub>x</sub> and N<sub>2</sub>O Measurements” to read as follows:

**§ 1065.274 Zirconium dioxide (ZrO<sub>2</sub>) NO<sub>x</sub> analyzer.**

(a) *Application.* You may use a zirconia oxide (ZrO<sub>2</sub>) analyzer to measure NO<sub>x</sub> in raw exhaust for field-testing engines.

(b) *Component requirements.* We recommend that you use a ZrO<sub>2</sub> analyzer that meets the specifications in Table 1 of § 1065.205. Note that your ZrO<sub>2</sub>-based system must meet the linearity verification in § 1065.307.

(c) *Species measured.* The ZrO<sub>2</sub>-based system must be able to measure and report NO and NO<sub>2</sub> together as NO<sub>x</sub>. If the ZrO<sub>2</sub>-based system cannot measure all of the NO<sub>2</sub>, you may develop and apply correction factors based on good engineering judgment to account for this deficiency.

(d) *Interference.* You must account for NH<sub>3</sub> interference with the NO<sub>x</sub> measurement.

■ 219. Amend § 1065.284 by revising the section heading to read as follows:

**§ 1065.284 Zirconium dioxide (ZrO<sub>2</sub>) air-fuel ratio and O<sub>2</sub> analyzer.**

\* \* \* \* \*

■ 220. Add § 1065.298 to read as follows:

**§ 1065.298 Correcting real-time PM measurement based on gravimetric PM filter measurement for field-testing analysis.**

(a) *Application.* You may quantify net PM on a sample medium for field testing with a continuous PM measurement with correction based on gravimetric PM filter measurement.

(b) *Measurement principles.* Photoacoustic or electrical aerosol instruments used in field-testing typically under-report PM emissions. Apply the verifications and corrections described in this section to meet accuracy requirements.

(c) *Component requirements.* (1) Gravimetric PM measurement must meet the laboratory measurement requirements of this part 1065, noting that there are specific exceptions to some laboratory requirements and specification for field testing given in § 1065.905(d)(2). In addition to those exceptions, field testing does not require you to verify proportional flow control as specified in § 1065.545. Note also that the linearity requirements of § 1065.307 apply only as specified in this section.

(2) Check the calibration and linearity of the photoacoustic and electrical aerosol instruments according to the instrument manufacturer’s instructions and the following recommendations:

(i) For photoacoustic instruments we recommend one of the following:

(A) Use a reference elemental carbon-based PM source to calibrate the instrument. Verify the photoacoustic instrument by comparing results either to a gravimetric PM measurement collected on the filter or to an elemental carbon analysis of collected PM.

(B) Use a light absorber that has a known amount of laser light absorption to periodically verify the instrument’s calibration factor. Place the light absorber in the path of the laser beam. This verification checks the integrity of the microphone sensitivity, the power of the laser diode, and the performance of the analog-to-digital converter.

(C) Verify that you meet the linearity requirements in Table 1 of § 1065.307 by generating a maximum reference PM mass concentration (verified gravimetrically) and then using partial-flow sampling to dilute to various evenly distributed concentrations.

(ii) For electrical aerosol instruments we recommend one of the following:

(A) Use reference monodisperse or polydisperse PM-like particles with a mobility diameter or count median diameter greater than 45 nm. Use an electrometer or condensation particle counter that has a d<sub>50</sub> at or below 10 nm to verify the reference values.

(B) Verify that you meet the linearity requirements in Table 1 of § 1065.307 using a maximum reference particle concentration, a zero-reference concentration, and at least two other evenly distributed points. Use partial-flow dilution to create the additional reference PM concentrations. The difference between measured values from the electrical aerosol and reference instruments at each point must be no greater than 15% of the mean value from the two measurements at that point.

(d) *Loss correction.* You may use PM loss corrections to account for PM loss in the sample handling system.

(e) *Correction.* Develop a multiplicative correction factor to ensure that total PM measured by photoacoustic or electrical aerosol instruments equate to the gravimetric filter-based total PM measurement. Calculate the correction factor by dividing the mass of PM captured on the gravimetric filter by the quantity represented by the total concentration of PM measured by the instrument multiplied by the time over the test

interval multiplied by the gravimetric filter sample flow rate.

■ 221. Amend § 1065.301 by revising paragraph (d) to read as follows:

**§ 1065.301 Overview and general provisions.**

\* \* \* \* \*

(d) Use NIST-traceable standards to the tolerances we specify for calibrations and verifications. Where we specify the need to use NIST-traceable standards, you may alternatively use international standards recognized by the CIPM Mutual Recognition Arrangement that are not NIST-traceable.

■ 222. Amend § 1065.305 by revising paragraph (d)(10)(ii) to read as follows:

**§ 1065.305 Verifications for accuracy, repeatability, and noise.**

\* \* \* \* \*

(d) \* \* \*

(10) \* \* \*

(ii) The measurement deficiency does not adversely affect your ability to demonstrate compliance with the applicable standards in this chapter.

■ 223. Amend § 1065.307 by revising paragraphs (b), (d) introductory text, and (f) to read as follows:

**§ 1065.307 Linearity verification.**

\* \* \* \* \*

(b) *Performance requirements.* If a measurement system does not meet the applicable linearity criteria referenced in Table 1 of this section, correct the deficiency by re-calibrating, servicing, or replacing components as needed. Repeat the linearity verification after correcting the deficiency to ensure that the measurement system meets the linearity criteria. Before you may use a measurement system that does not meet linearity criteria, you must demonstrate to us that the deficiency does not adversely affect your ability to demonstrate compliance with the applicable standards in this chapter.

\* \* \* \* \*

(d) *Reference signals.* This paragraph (d) describes recommended methods for generating reference values for the linearity-verification protocol in paragraph (c) of this section. Use reference values that simulate actual values, or introduce an actual value and measure it with a reference-measurement system. In the latter case, the reference value is the value reported by the reference-measurement system. Reference values and reference-measurement systems must be NIST-traceable. We recommend using calibration reference quantities that are NIST-traceable within ±0.5% uncertainty, if not specified elsewhere

in this part 1065. Use the following recommended methods to generate

reference values or use good engineering judgment to select a different reference:

(f) Performance criteria for measurement systems. Table 1 follows:

\* \* \* \* \*

TABLE 1 OF § 1065.307—MEASUREMENT SYSTEMS THAT REQUIRE LINEARITY VERIFICATION

Table with 6 columns: Measurement system, Quantity, |x\_min(a1-1)+a0|, a1, SEE, r^2. Rows include Speed, Torque, Electrical power, Current, Voltage, Fuel flow rate, Fuel mass scale, DEF flow rate, DEF mass scale, Intake-air flow rate, Dilution air flow rate, Diluted exhaust flow rate, Raw exhaust flow rate, Batch sampler flow rates, Gas dividers, Gas analyzers for laboratory testing, Gas analyzers for field testing, Electrical aerosol analyzer for field testing, Photoacoustic analyzer for field testing, PM balance, Pressures, Dewpoint for intake air, PM-stabilization and balance environments, Other dewpoint measurements, Analog-to-digital conversion of temperature signals.

a For flow meters that determine volumetric flow rate, V\_std, you may substitute V\_std for n as the quantity and substitute V\_stdmax for n\_max.

\* \* \* \* \*

■ 224. Amend § 1065.308 by revising paragraph (e)(3) to read as follows:

§ 1065.308 Continuous gas analyzer system-response and updating-recording verification—for gas analyzers not continuously compensated for other gas species.

\* \* \* \* \*

(e) \* \* \*

(3) If a measurement system fails the criteria in paragraphs (e)(1) and (2) of this section, you may use the measurement system only if the deficiency does not adversely affect your ability to show compliance with the applicable standards in this chapter.

\* \* \* \* \*

■ 225. Amend § 1065.309 by revising paragraph (e)(3) to read as follows:

§ 1065.309 Continuous gas analyzer system-response and updating-recording verification—for gas analyzers continuously compensated for other gas species.

\* \* \* \* \*

(e) \* \* \*

(3) If a measurement system fails the criteria in paragraphs (e)(1) and (2) of this section, you may use the measurement system only if the deficiency does not adversely affect

your ability to show compliance with the applicable standards in this chapter.

\* \* \* \* \*

■ 226. Amend § 1065.315 by revising paragraphs (a)(1) through (3) and (b) to read as follows:

§ 1065.315 Pressure, temperature, and dewpoint calibration.

(a) \* \* \*

(1) Pressure. We recommend temperature-compensated, digital-pneumatic, or deadweight pressure calibrators, with data-logging capabilities to minimize transcription errors. We recommend using calibration reference quantities that are NIST-traceable within ±0.5% uncertainty.

(2) Temperature. We recommend digital dry-block or stirred-liquid temperature calibrators, with data logging capabilities to minimize transcription errors. We recommend using calibration reference quantities that are NIST-traceable within ±0.5% uncertainty. You may perform linearity verification for temperature measurement systems with thermocouples, RTDs, and thermistors by removing the sensor from the system and using a simulator in its place. Use a NIST-traceable simulator that is

independently calibrated and, as appropriate, cold-junction compensated. The simulator uncertainty scaled to absolute temperature must be less than 0.5% of T\_max. If you use this option, you must use sensors that the supplier states are accurate to better than 0.5% of T\_max compared with their standard calibration curve.

(3) Dewpoint. We recommend a minimum of three different temperature-equilibrated and temperature-monitored calibration salt solutions in containers that seal completely around the dewpoint sensor. We recommend using calibration reference quantities that are NIST-traceable within ±0.5% uncertainty.

(b) You may remove system components for off-site calibration. We recommend specifying calibration reference quantities that are NIST-traceable within ±0.5% uncertainty.

■ 227. Amend § 1065.320 by revising paragraph (c) to read as follows:

§ 1065.320 Fuel-flow calibration.

\* \* \* \* \*

(c) You may remove system components for off-site calibration. When installing a flow meter with an off-site calibration, we recommend that

you consider the effects of the tubing configuration upstream and downstream of the flow meter. We recommend specifying calibration reference quantities that are NIST-traceable within  $\pm 0.5\%$  uncertainty.

■ 228. Amend § 1065.325 by revising paragraphs (a) and (b) to read as follows:

**§ 1065.325 Intake-flow calibration.**

(a) Calibrate intake-air flow meters upon initial installation. Follow the instrument manufacturer's instructions and use good engineering judgment to repeat the calibration. We recommend using a calibration subsonic venturi, ultrasonic flow meter or laminar flow element. We recommend using calibration reference quantities that are NIST-traceable within  $\pm 0.5\%$  uncertainty.

(b) You may remove system components for off-site calibration. When installing a flow meter with an off-site calibration, we recommend that you consider the effects of the tubing configuration upstream and downstream of the flow meter. We recommend specifying calibration reference quantities that are NIST-traceable within  $\pm 0.5\%$  uncertainty.

\* \* \* \* \*

■ 229. Amend § 1065.330 by revising paragraphs (a) and (b) to read as follows:

**§ 1065.330 Exhaust-flow calibration.**

(a) Calibrate exhaust-flow meters upon initial installation. Follow the instrument manufacturer's instructions and use good engineering judgment to repeat the calibration. We recommend that you use a calibration subsonic venturi or ultrasonic flow meter and simulate exhaust temperatures by incorporating a heat exchanger between the calibration meter and the exhaust-flow meter. If you can demonstrate that the flow meter to be calibrated is insensitive to exhaust temperatures, you may use other reference meters such as laminar flow elements, which are not commonly designed to withstand typical raw exhaust temperatures. We recommend using calibration reference quantities that are NIST-traceable within  $\pm 0.5\%$  uncertainty.

(b) You may remove system components for off-site calibration. When installing a flow meter with an off-site calibration, we recommend that you consider the effects of the tubing configuration upstream and downstream of the flow meter. We recommend specifying calibration reference quantities that are NIST-traceable within  $\pm 0.5\%$  uncertainty.

\* \* \* \* \*

■ 230. Amend § 1065.341 by revising paragraph (e)(3) to read as follows:

**§ 1065.341 CVS and PFD flow verification (propane check).**

\* \* \* \* \*

(e) \* \* \*

(3) Calculate total  $C_3H_8$  mass based on your CVS and HC data as described in § 1065.650 (40 CFR 1066.605 for vehicle testing) and § 1065.660, using the molar mass of  $C_3H_8$ ,  $M_{C_3H_8}$ , instead of the effective molar mass of HC,  $M_{HC}$ .

\* \* \* \* \*

■ 231. Amend § 1065.345 by revising paragraph (d) to read as follows:

**§ 1065.345 Vacuum-side leak verification.**

\* \* \* \* \*

(d) *Dilution-of-span-gas leak test.* You may use any gas analyzer for this test. If you use a FID for this test, correct for any HC contamination in the sampling system according to § 1065.660. If you use an  $O_2$  analyzer described in § 1065.280 for this test, you may use purified  $N_2$  to detect a leak. To avoid misleading results from this test, we recommend using only analyzers that have a repeatability of 0.5% or better at the reference gas concentration used for this test. Perform a vacuum-side leak test as follows:

(1) Prepare a gas analyzer as you would for emission testing.

(2) Supply reference gas to the analyzer span port and record the measured value.

(3) Route overflow reference gas to the inlet of the sample probe or at a tee fitting in the transfer line near the exit of the probe. You may use a valve upstream of the overflow fitting to prevent overflow of reference gas out of the inlet of the probe, but you must then provide an overflow vent in the overflow supply line.

(4) Verify that the measured overflow reference gas concentration is within  $\pm 0.5\%$  of the concentration measured in paragraph (d)(2) of this section. A measured value lower than expected indicates a leak, but a value higher than expected may indicate a problem with the reference gas or the analyzer itself. A measured value higher than expected does not indicate a leak.

\* \* \* \* \*

■ 232. Amend § 1065.350 by revising paragraph (e)(1) to read as follows:

**§ 1065.350  $H_2O$  interference verification for  $CO_2$  NDIR analyzers.**

\* \* \* \* \*

(e) \* \* \*

(1) You may omit this verification if you can show by engineering analysis that for your  $CO_2$  sampling system and your emission-calculation procedures,

the  $H_2O$  interference for your  $CO_2$  NDIR analyzer always affects your brake-specific emission results within  $\pm 0.5\%$  of each of the applicable standards in this chapter. This specification also applies for vehicle testing, except that it relates to emission results in g/mile or g/kilometer.

\* \* \* \* \*

■ 233. Amend § 1065.405 by revising paragraph (a) to read as follows:

**§ 1065.405 Test engine preparation and maintenance.**

\* \* \* \* \*

(a) If you are testing an emission-data engine for certification, make sure it is built to represent production engines, consistent with paragraph (f) of this section.

(1) This includes governors that you normally install on production engines. Production engines should also be tested with their installed governors. If your engine is equipped with multiple user-selectable governor types and if the governor does not manipulate the emission control system (*i.e.*, the governor only modulates an "operator demand" signal such as commanded fuel rate, torque, or power), choose the governor type that allows the test cell to most accurately follow the duty cycle. If the governor manipulates the emission control system, treat it as an adjustable parameter. If you do not install governors on production engines, simulate a governor that is representative of a governor that others will install on your production engines.

(2) In certain circumstances, you may incorporate test cell components to simulate an in-use configuration, consistent with good engineering judgment. For example, §§ 1065.122 and 1065.125 allow the use of test cell components to represent engine cooling and intake air systems.

(3) The provisions in § 1065.110(e) also apply to emission-data engines for certification.

(4) For engines using SCR, use any size DEF tank and fuel tank. We may require you to give us a production-type DEF tank, including any associated sensors, for our testing.

\* \* \* \* \*

■ 234. Amend § 1065.410 by revising paragraph (c) to read as follows:

**§ 1065.410 Maintenance limits for stabilized test engines.**

\* \* \* \* \*

(c) If you inspect an engine, keep a record of the inspection and update your application for certification to document any changes that result. You may use any kind of equipment,

instrument, or tool that is available at dealerships and other service outlets to identify malfunctioning components or perform maintenance. You may inspect using electronic tools or internal engine systems to monitor engine performance, but only if the information is readable without specialized equipment.

\* \* \* \* \*

■ 235. Amend § 1065.501 by revising paragraph (a) introductory text to read as follows:

**§ 1065.501 Overview.**

(a) Use the procedures detailed in this subpart to measure engine emissions over a specified duty cycle. Refer to subpart J of this part for field test procedures that describe how to measure emissions during in-use engine operation. Refer to subpart L of this part for measurement procedures for testing related to standards other than brake-specific emission standards. This section describes how to—

\* \* \* \* \*

■ 236. Amend § 1065.510 by revising paragraphs (a) introductory text, (b) introductory text, (b)(4) through (6), (c)(2), (d) introductory text, (d)(4), (d)(5)(iii), and (g)(2) to read as follows:

**§ 1065.510 Engine mapping.**

(a) *Applicability, scope, and frequency.* An engine map is a data set that consists of a series of paired data points that represent the maximum brake torque versus engine speed, measured at the engine's primary output shaft. Map your engine if the standard-setting part requires engine mapping to generate a duty cycle for your engine configuration. Map your engine while it is connected to a dynamometer or other device that can absorb work output from the engine's primary output shaft according to § 1065.110. Configure any auxiliary work inputs and outputs such as hybrid, turbo-compounding, or thermoelectric systems to represent their in-use configurations, and use the same configuration for emission testing. See Figure 1 of § 1065.210. This may involve configuring initial states of charge and rates and times of auxiliary-work inputs and outputs. We recommend that you contact the EPA Program Officer before testing to determine how you should configure any auxiliary-work inputs and outputs. If your engine has an auxiliary emission control device to reduce torque output that may activate during engine mapping, turn it off before mapping. Use the most recent engine map to transform a normalized duty cycle from the standard-setting part to a reference duty cycle specific to your engine.

Normalized duty cycles are specified in the standard-setting part. You may update an engine map at any time by repeating the engine-mapping procedure. You must map or re-map an engine before a test if any of the following apply:

\* \* \* \* \*

(b) *Mapping variable-speed engines.* Map variable-speed engines using the procedure in this paragraph (b). Note that under § 1065.10(c) we may allow or require you to use "other procedures" if the specified procedure results in unrepresentative testing or if your engine cannot be tested using the specified procedure. If the engine has a user-adjustable idle speed setpoint, you may set it to its minimum adjustable value for this mapping procedure and the resulting map may be used for any test, regardless of where it is set for running each test.

\* \* \* \* \*

(4) Operate the engine at the minimum mapped speed. A minimum mapped speed equal to  $(95 \pm 1)\%$  of its warm idle speed determined in paragraph (b)(3) of this section may be used for any engine or test. A higher minimum mapped speed may be used if all the duty cycles that the engine is subject to have a minimum reference speed higher than the warm idle speed determined in paragraph (b)(3) of this section. In this case you may use a minimum mapped speed equal to  $(95 \pm 1)\%$  of the lowest minimum reference speed in all the duty cycles the engine is subject to. Set operator demand to maximum and control engine speed at this minimum mapped speed for at least 15 seconds. Set operator demand to maximum and control engine speed at  $(95 \pm 1)\%$  of its warm idle speed determined in paragraph (b)(3)(i) of this section for at least 15 seconds.

(5) Perform a continuous or discrete engine map as described in paragraphs (b)(5)(i) or (ii) of this section. A continuous engine map may be used for any engine. A discrete engine map may be used for engines subject only to steady-state duty cycles. Use linear interpolation between the series of points generated by either of these maps to determine intermediate torque values. Use the series of points generated by either of these maps to generate the power map as described in paragraph (e) of this section.

(i) For continuous engine mapping, begin recording mean feedback speed and torque at 1 Hz or more frequently and increase speed at a constant rate such that it takes (4 to 6) min to sweep from the minimum mapped speed described in paragraphs (b)(4) of this

section to the check point speed described in paragraph (b)(5)(iii) of this section. Use good engineering judgment to determine when to stop recording data to ensure that the sweep is complete. In most cases, this means that you can stop the sweep at any point after the power falls to 50% of the maximum value.

(ii) For discrete engine mapping, select at least 20 evenly spaced setpoints from the minimum mapped speed described in paragraph (b)(4) of this section to the check point speed described in paragraph (b)(5)(iii) of this section. At each setpoint, stabilize speed and allow torque to stabilize. We recommend that you stabilize an engine for at least 15 seconds at each setpoint and record the mean feedback speed and torque of the last (4 to 6) seconds. Record the mean speed and torque at each setpoint.

(iii) The check point speed of the map is the highest speed above maximum power at which 50% of maximum power occurs. If this speed is unsafe or unachievable (e.g., for ungoverned engines or engines that do not operate at that point), use good engineering judgment to map up to the maximum safe speed or maximum achievable speed. For discrete mapping, if the engine cannot be mapped to the check point speed, make sure the map includes at least 20 points from 95% of warm idle to the maximum mapped speed. For continuous mapping, if the engine cannot be mapped to the check point speed, verify that the sweep time from 95% of warm idle to the maximum mapped speed is (4 to 6) min.

(iv) Note that under § 1065.10(c)(1) we may allow you to disregard portions of the map when selecting maximum test speed if the specified procedure would result in a duty cycle that does not represent in-use operation.

(6) Determine warm high-idle speed for engines with a high-speed governor. You may skip this if the engine is not subject to transient testing with a duty cycle that includes reference speed values above 100%. You may use a manufacturer-declared warm high-idle speed if the engine is electronically governed. For engines with a high-speed governor that regulates speed by disabling and enabling fuel or ignition at two manufacturer-specified speeds, declare the middle of this specified speed range as the warm high-idle speed. You may alternatively measure warm high-idle speed using the following procedure:

(i) Run an operating point targeting zero torque.

(A) Set operator demand to maximum and use the dynamometer to target zero

torque on the engine's primary output shaft.

(B) Wait for the engine governor and dynamometer to stabilize. We recommend that you stabilize for at least 15 seconds.

(C) Record 1 Hz means of the feedback speed and torque for at least 30 seconds. You may record means at a higher frequency as long as there are no gaps in the recorded data. For engines with a high-speed governor that regulates speed by disabling and enabling fuel or ignition, you may need to extend this stabilization period to include at least one disabling event at the higher speed and one enabling event at the lower speed.

(D) Determine if the feedback speed is stable over the recording period. The feedback speed is considered stable if all the recorded 1 Hz means are within  $\pm 2\%$  of the mean feedback speed over the recording period. If the feedback speed is not stable because of the dynamometer, void the results and repeat measurements after making any necessary corrections. You may void and repeat the entire map sequence, or you may void and replace only the results for establishing warm high-idle speed; use good engineering judgment to warm-up the engine before repeating measurements.

(E) If the feedback speed is stable, use the mean feedback speed over the recording period as the measured speed for this operating point.

(F) If the feedback speed is not stable because of the engine, determine the mean as the value representing the midpoint between the observed maximum and minimum recorded feedback speed.

(G) If the mean feedback torque over the recording period is within  $(0 \pm 1)\%$  of  $T_{\max \text{ mapped}}$ , use the measured speed for this operating point as the warm high-idle speed. Otherwise, continue testing as described in paragraph (b)(6)(ii) of this section.

(i) Run a second operating point targeting a positive torque. Follow the same procedure in paragraphs (b)(6)(i)(A) through (F) of this section, except that the dynamometer is set to target a torque equal to the mean feedback torque over the recording period from the previous operating point plus 20% of  $T_{\max \text{ mapped}}$ .

(iii) Use the mean feedback speed and torque values from paragraphs (b)(6)(i) and (ii) of this section to determine the warm high-idle speed. If the two recorded speed values are the same, use that value as the warm high-idle-speed. Otherwise, use a linear equation passing through these two speed-torque points and extrapolate to solve for the speed at

zero torque and use this speed intercept value as the warm high-idle speed.

(iv) You may use a manufacturer-declared  $T_{\max}$  instead of the measured  $T_{\max \text{ mapped}}$ . If you do this, you may also measure the warm high-idle speed as described in this paragraph (b)(6) before running the operating point and speed sweeps specified in paragraphs (b)(4) and (5) of this section.

\* \* \* \* \*

(c) \* \* \*

(2) Map the amount of negative torque required to motor the engine by repeating paragraph (b) of this section with minimum operator demand, as applicable. You may start the negative torque map at either the minimum or maximum speed from paragraph (b) of this section.

\* \* \* \* \*

(d) *Mapping constant-speed engines.* Map constant-speed engines using the procedure in this paragraph (d). When testing without a motoring dynamometer (e.g., eddy-current or water-brake dynamometer or any device that is already installed on a vehicle, equipment, or vessel) operate these devices over the no-load operating points in the procedure as close to no-load as possible.

\* \* \* \* \*

(4) With the governor or simulated governor controlling speed using operator demand, operate the engine at the no-load, or minimum achievable load, governed speed (at high speed, not low idle) for at least 15 seconds.

(5) \* \* \*

(iii) For any isochronous governed (0% speed droop) constant-speed engine, you may map the engine with two points as described in this paragraph (d)(5)(iii). After stabilizing at the no-load, or minimum achievable load, governed speed in paragraph (d)(4) of this section, record the mean feedback speed and torque. Continue to operate the engine with the governor or simulated governor controlling engine speed using operator demand, and control the dynamometer to target a speed of 99.5% of the recorded mean no-load governed speed. Allow speed and torque to stabilize. Record the mean feedback speed and torque. Record the target speed. The absolute value of the speed error (the mean feedback speed minus the target speed) must be no greater than 0.1% of the recorded mean no-load governed speed. From this series of two mean feedback speed and torque values, use linear interpolation to determine intermediate values. Use this series of two mean feedback speeds and torques to generate a power map as described in paragraph (e) of this

section. Note that the measured maximum test torque as determined in § 1065.610(b)(1) will be the mean feedback torque recorded on the second point.

\* \* \* \* \*

(g) \* \* \*

(2) The purpose of the mapping procedure in this paragraph (g) is to determine the maximum torque available at each speed, such as what might occur during transient operation with a fully charged RESS. Use one of the following methods to generate a hybrid-active map:

(i) Perform an engine map by using a series of continuous sweeps to cover the engine's full range of operating speeds. Prepare the engine for hybrid-active mapping by ensuring that the RESS state of charge is representative of normal operation. Perform the sweep as specified in paragraph (b)(5)(i) of this section, but stop the sweep to charge the RESS when the power measured from the RESS drops below the expected maximum power from the RESS by more than 2% of total system power (including engine and RESS power). Unless good engineering judgment indicates otherwise, assume that the expected maximum power from the RESS is equal to the measured RESS power at the start of the sweep segment. For example, if the 3-second rolling average of total engine-RESS power is 200 kW and the power from the RESS at the beginning of the sweep segment is 50 kW, once the power from the RESS reaches 46 kW, stop the sweep to charge the RESS. Note that this assumption is not valid where the hybrid motor is torque-limited. Calculate total system power as a 3-second rolling average of instantaneous total system power. After each charging event, stabilize the engine for 15 seconds at the speed at which you ended the previous segment with operator demand set to maximum before continuing the sweep from that speed. Repeat the cycle of charging, mapping, and recharging until you have completed the engine map. You may shut down the system or include other operation between segments to be consistent with the intent of this paragraph (g)(2)(i). For example, for systems in which continuous charging and discharging can overheat batteries to an extent that affects performance, you may operate the engine at zero power from the RESS for enough time after the system is recharged to allow the batteries to cool. Use good engineering judgment to smooth the torque curve to eliminate discontinuities between map intervals.

(ii) Perform an engine map by using discrete speeds. Select map setpoints at intervals defined by the ranges of engine speed being mapped. From 95% of warm idle speed to 90% of the expected maximum test speed, select setpoints that result in a minimum of 13 equally spaced speed setpoints. From 90% to 110% of expected maximum test speed, select setpoints in equally spaced intervals that are nominally 2% of expected maximum test speed. Above 110% of expected maximum test speed, select setpoints based on the same speed intervals used for mapping from 95% warm idle speed to 90% maximum test speed. You may stop mapping at the highest speed above maximum power at which 50% of maximum power occurs. We refer to the speed at 50% power as the check point speed as described in paragraph (b)(5)(iii) of this section. Stabilize engine speed at each setpoint, targeting a torque value at 70% of peak torque at that speed without hybrid-assist. Make sure the engine is fully warmed up and the RESS state of charge is within the normal operating range. Snap the operator demand to maximum, operate the engine there for at least 10 seconds, and record the 3-second rolling average feedback speed and torque at 1 Hz or higher. Record the peak 3-second average torque and 3-second average speed at that point. Use linear interpolation to determine intermediate speeds and torques. Follow § 1065.610(a) to calculate the maximum test speed. Verify that the measured maximum test speed falls in the range from 92 to 108% of the estimated maximum test speed. If the measured maximum test speed does not fall in this

range, repeat the map using the measured value of maximum test speed.

\* \* \* \* \*

■ 237. Amend § 1065.512 by revising paragraph (b)(1) to read as follows:

**§ 1065.512 Duty cycle generation.**

\* \* \* \* \*

(b) \* \* \*  
 (1) *Engine speed for variable-speed engines.* For variable-speed engines, normalized speed may be expressed as a percentage between warm idle speed,  $f_{idle}$ , and maximum test speed,  $f_{ntest}$ , or speed may be expressed by referring to a defined speed by name, such as “warm idle,” “intermediate speed,” or “A,” “B,” or “C” speed. Section 1065.610 describes how to transform these normalized values into a sequence of reference speeds,  $f_{nref}$ . Running duty cycles with negative or small normalized speed values near warm idle speed may cause low-speed idle governors to activate and the engine torque to exceed the reference torque even though the operator demand is at a minimum. In such cases, we recommend controlling the dynamometer so it gives priority to follow the reference torque instead of the reference speed and let the engine govern the speed. Note that the cycle-validation criteria in § 1065.514 allow an engine to govern itself. This allowance permits you to test engines with enhanced-idle devices and to simulate the effects of transmissions such as automatic transmissions. For example, an enhanced-idle device might be an idle speed value that is normally commanded only under cold-start conditions to quickly warm up the engine and aftertreatment devices. In this case, negative and very low normalized speeds will generate

reference speeds below this higher enhanced-idle speed. You may do either of the following when using enhanced-idle devices:

(i) Control the dynamometer so it gives priority to follow the reference torque, controlling the operator demand so it gives priority to follow reference speed and let the engine govern the speed when the operator demand is at minimum.

(ii) While running an engine where the ECM broadcasts an enhanced-idle speed that is above the denormalized speed, use the broadcast speed as the reference speed. Use these new reference points for duty-cycle validation. This does not affect how you determine denormalized reference torque in paragraph (b)(2) of this section.

(iii) If an ECM broadcast signal is not available, perform one or more practice cycles to determine the enhanced-idle speed as a function of cycle time. Generate the reference cycle as you normally would but replace any reference speed that is lower than the enhanced-idle speed with the enhanced-idle speed. This does not affect how you determine denormalized reference torque in paragraph (b)(2) of this section.

\* \* \* \* \*

■ 238. Amend § 1065.514 by revising paragraph (d) to read as follows

**§ 1065.514 Cycle-validation criteria for operation over specified duty cycles.**

\* \* \* \* \*

(d) *Omitting additional points.* Besides engine cranking, you may omit additional points from cycle-validation statistics as described in the following table:

TABLE 1 TO PARAGRAPH (d) OF § 1065.514—PERMISSIBLE CRITERIA FOR OMITTING POINTS FROM DUTY-CYCLE REGRESSION STATISTICS

When operator demand is at its . . .	you may omit . . .	if . . .
<b>For reference duty cycles that are specified in terms of speed and torque (<math>f_{nref}</math>, <math>T_{ref}</math>)</b>		
minimum .....	power and torque .....	$T_{ref} < 0\%$ (motoring).
minimum .....	power and speed .....	$f_{nref} = 0\%$ (idle speed) and $T_{ref} = 0\%$ (idle torque) and $T_{ref} - (2\% \cdot T_{max \text{ mapped}}) < T < T_{ref} + (2\% \cdot T_{max \text{ mapped}})$ .
minimum .....	power and speed .....	$f_{nref} < \text{enhanced-idle speed}^a$ and $T_{ref} > 0\%$ .
minimum .....	power and either torque or speed .....	$f_n > f_{nref}$ or $T > T_{ref}$ but not if $f_n > (f_{nref} \cdot 102\%)$ and $T > T_{ref} + (2\% \cdot T_{max \text{ mapped}})$ .
maximum .....	power and either torque or speed .....	$f_n < f_{nref}$ or $T < T_{ref}$ but not if $f_n < (f_{nref} \cdot 98\%)$ and $T < T_{ref} - (2\% \cdot T_{max \text{ mapped}})$ .
<b>For reference duty cycles that are specified in terms of speed and power (<math>f_{nref}</math>, <math>P_{ref}</math>)</b>		
minimum .....	power and torque .....	$P_{ref} < 0\%$ (motoring).
minimum .....	power and speed .....	$f_{nref} = 0\%$ (idle speed) and $P_{ref} = 0\%$ (idle power) and $P_{ref} - (2\% \cdot P_{max \text{ mapped}}) < P < P_{ref} + (2\% \cdot P_{max \text{ mapped}})$ .
minimum .....	power and either torque or speed .....	$f_n > f_{nref}$ or $P > P_{ref}$ but not if $f_n > (f_{nref} \cdot 102\%)$ and $P > P_{ref} + (2\% \cdot P_{max \text{ mapped}})$ .
maximum .....	power and either torque or speed .....	$f_n < f_{nref}$ or $P < P_{ref}$ but not if $f_n < (f_{nref} \cdot 98\%)$ and $P < P_{ref} - (2\% \cdot P_{max \text{ mapped}})$ .

<sup>a</sup> Determine enhanced-idle speed from ECM broadcast or a practice cycle.

\* \* \* \* \*

■ 239. Amend § 1065.530 by revising paragraph (g)(5) introductory text to read as follows:

**§ 1065.530 Emission test sequence.**

\* \* \* \* \*

(g) \* \* \*

(5) If you perform the optional carbon balance error verification, verify carbon balance error as specified in the standard-setting part and § 1065.543. Calculate and report the three carbon balance error quantities for each test interval; carbon mass absolute error for a test interval,  $\epsilon_{aC}$ , carbon mass rate absolute error for a test interval,  $\epsilon_{aCrate}$ , and carbon mass relative error for a test interval,  $\epsilon_{rC}$ . For duty cycles with multiple test intervals, you may calculate and report the composite carbon mass relative error,  $\epsilon_{rCcomp}$ , for the whole duty cycle. If you report  $\epsilon_{rCcomp}$ , you must still calculate and report  $\epsilon_{aC}$ ,  $\epsilon_{aCrate}$ , and  $\epsilon_{rC}$  for each test interval.

\* \* \* \* \*

■ 240. Amend § 1065.543 by revising paragraphs (a) and (b) to read as follows:

**§ 1065.543 Carbon balance error verification.**

(a) This optional carbon balance error verification compares independently calculated quantities of carbon flowing into and out of an engine system. The engine system includes aftertreatment devices as applicable. Calculating carbon intake considers carbon-carrying streams flowing into the system, including intake air, fuel, and optionally DEF or other fluids. Carbon flow out of the system comes from exhaust emission calculations. Note that this verification is not valid if you calculate exhaust molar flow rate using fuel rate and chemical balance as described in § 1065.655(f)(3) because carbon flows into and out of the system are not independent. Use good engineering judgment to ensure that carbon mass in and carbon mass out data signals align.

(b) Perform the carbon balance error verification after emission sampling is complete for a test sequence as described in § 1065.530(g)(5). Testing must include measured values as needed to determine intake air, fuel flow, and carbon-related gaseous exhaust emissions. You may optionally account for the flow of carbon-carrying fluids other than intake air and fuel into the system. Perform carbon balance error verification as follows:

(1) Calculate carbon balance error quantities as described in § 1065.643. The three quantities for individual test intervals are carbon mass absolute error,  $\epsilon_{aC}$ , carbon mass rate absolute error,

$\epsilon_{aCrate}$ , and carbon mass relative error,  $\epsilon_{rC}$ . Determine  $\epsilon_{aC}$ ,  $\epsilon_{aCrate}$ , and  $\epsilon_{rC}$  for all test intervals. You may determine composite carbon mass relative error,  $\epsilon_{rCcomp}$ , as a fourth quantity that optionally applies for duty cycles with multiple test intervals.

(2) You meet the carbon balance error verification for a test sequence if all test intervals pass the test-interval criteria. A test interval passes if at least one of the absolute values of the three carbon balance error quantities for test intervals,  $\epsilon_{aC}$ ,  $\epsilon_{aCrate}$ , and  $\epsilon_{rC}$ , is at or below its respective limit value in paragraphs (b)(2)(i) through (iii) of this section. You meet the carbon balance error verification for a duty cycle with multiple test intervals if the duty cycle passes the duty-cycle criterion. A duty cycle passes if the absolute value of the composite carbon mass relative error quantity,  $\epsilon_{rCcomp}$ , is at or below the limit value in paragraph (b)(2)(iii) of this section. Unless specified otherwise in the standard-setting part, if verification fails for a test sequence, you may repeat the entire test sequence or repeat individual test intervals as described in § 1065.526.

(i) Calculate the carbon mass absolute error limit,  $L_{\epsilon aC}$ , in grams to three decimal places for comparison to the absolute value of  $\epsilon_{aC}$ , using the following equation:

$$L_{\epsilon aC} = c \cdot P_{max}$$

Eq. 1065.543-1

Where:

$c$  = power-specific carbon mass absolute error coefficient = 0.007 g/kW.

$P_{max}$  = maximum power from the engine map generated according to § 1065.510. If measured  $P_{max}$  is not available, use a manufacturer-declared value for  $P_{max}$ .

Example:

$$c = 0.007 \text{ g/kW}$$

$$P_{max} = 230.0 \text{ kW}$$

$$L_{\epsilon aC} = 0.007 \cdot 230.0$$

$$L_{\epsilon aC} = 1.610 \text{ g}$$

(ii) Calculate the carbon mass rate absolute error limit,  $L_{\epsilon aCrate}$ , in grams per hour to three decimal places for comparison to the absolute value of  $\epsilon_{aCrate}$ , using the following equation:

$$L_{\epsilon aCrate} = d \cdot P_{max}$$

Eq. 1065.543-2

Where:

$d$  = power-specific carbon mass rate absolute error coefficient = 0.31 g/(kW·hr).

$P_{max}$  = maximum power from the engine map generated according to § 1065.510. If measured  $P_{max}$  is not available, use a manufacturer-declared value for  $P_{max}$ .

Example:

$$d = 0.31 \text{ g/(kW·hr)}$$

$$P_{max} = 230.0 \text{ kW}$$

$$L_{\epsilon aCrate} = 0.31 \cdot 230.0$$

$$L_{\epsilon aCrate} = 71.300 \text{ g/hr}$$

(iii) The carbon mass relative error limit,  $L_{\epsilon rC}$ , is 0.020 for comparison to the absolute value of  $\epsilon_{rC}$ , and to the absolute value of  $\epsilon_{rCcomp}$ .

\* \* \* \* \*

■ 241. Amend § 1065.545 by revising paragraphs (a) and (b) introductory text to read as follows:

**§ 1065.545 Verification of proportional flow control for batch sampling.**

\* \* \* \* \*

(a) For any pair of sample and total flow rates, use continuous recorded data or 1 Hz means. Total flow rate means the raw exhaust flow rate for raw exhaust sampling and the dilute exhaust flow rate for CVS sampling. For each test interval, determine the standard error of the estimate, *SEE*, of the sample flow rate versus the total flow rate as described in § 1065.602, forcing the intercept to zero. Determine the mean sample flow rate over each test interval as described in § 1065.602. For each test interval, demonstrate that *SEE* is at or below 3.5% of the mean sample flow rate.

(b) For any pair of sample and total flow rates, use continuous recorded data or 1 Hz means. Total flow rate means the raw exhaust flow rate for raw exhaust sampling and the dilute exhaust flow rate for CVS sampling. For each test interval, demonstrate that each flow rate is constant within  $\pm 2.5\%$  of its respective mean or target flow rate. You may use the following options instead of recording the respective flow rate of each type of meter:

\* \* \* \* \*

■ 242. Amend § 1065.610 by:

- a. Revising the introductory text, paragraphs (a) introductory text, (a)(1) introductory text, and (a)(3).
- b. Removing paragraph (a)(4).
- c. Revising paragraphs (b) introductory text, (b)(1) introductory text, (b)(2) and (3), and (c)(2).

The revisions read as follows:

**§ 1065.610 Duty cycle generation.**

This section describes how to generate duty cycles that are specific to your engine, based on the normalized duty cycles in the standard-setting part. During an emission test, use a duty cycle that is specific to your engine to command engine speed, torque, and power, as applicable, using an engine dynamometer and an engine operator demand. Paragraphs (a) and (b) of this section describe how to “normalize” your engine’s map to determine the maximum test speed or torque for your



engine. The rest of this section describes how to use these values to “denormalize” the duty cycles in the standard-setting parts, which are all published on a normalized basis. Thus, the term “normalized” in paragraphs (a) and (b) of this section refers to different values than it does in the rest of the section.

(a) *Maximum test speed,  $f_{ntest}$ .* For variable-speed engines, determine  $f_{ntest}$  from the torque and power maps, generated according to § 1065.510, as follows:

(1) Determine a measured value for  $f_{ntest}$  as follows:

\* \* \* \* \*

(3) Transform normalized speeds to reference speeds according to paragraph (c) of this section by using the measured maximum test speed determined according to paragraphs (a)(1) and (2) of this section—or use your declared maximum test speed, as allowed in § 1065.510.

(b) *Maximum test torque,  $T_{test}$ .* For constant-speed engines, determine  $T_{test}$  from the torque and power-versus-speed maps, generated according to § 1065.510, as follows:

(1) For constant speed engines mapped using the methods in § 1065.510(d)(5)(i) or (ii), determine a measured value for  $T_{test}$  as follows:

\* \* \* \* \*

(2) For constant speed engines using the two-point mapping method in § 1065.510(d)(5)(iii), you may follow paragraph (a)(1) of this section to determine the measured  $T_{test}$ , or you may use the measured torque of the second point as the measured  $T_{test}$  directly.

(3) Transform normalized torques to reference torques according to paragraph (d) of this section by using the measured maximum test torque determined according to paragraph (b)(1) or (2) of this section—or use your declared maximum test torque, as allowed in § 1065.510.

(c) \* \* \*

(2) *A, B, C, and D speeds.* If your normalized duty cycle specifies speeds as A, B, C, or D values, use your power-versus-speed curve to determine the lowest speed below maximum power at which 50% of maximum power occurs. Denote this value as  $n_{lo}$ . Take  $n_{lo}$  to be warm idle speed if all power points at speeds below the maximum power speed are higher than 50% of maximum power. Also determine the highest speed above maximum power at which 70% of maximum power occurs. Denote this value as  $n_{hi}$ . If all power points at

speeds above the maximum power speed are higher than 70% of maximum power, take  $n_{hi}$  to be the declared maximum safe engine speed or the declared maximum representative engine speed, whichever is lower. Use  $n_{hi}$  and  $n_{lo}$  to calculate reference values for A, B, C, or D speeds as follows:

$$f_{nrefA} = 0.25 \cdot (n_{hi} - n_{lo}) + n_{lo}$$

Eq. 1065.610-4

$$f_{nrefB} = 0.50 \cdot (n_{hi} - n_{lo}) + n_{lo}$$

Eq. 1065.610-5

$$f_{nrefC} = 0.75 \cdot (n_{hi} - n_{lo}) + n_{lo}$$

Eq. 1065.610-6

$$f_{nrefD} = 0.15 \cdot (n_{hi} - n_{lo}) + n_{lo}$$

Eq. 1065.610-7

*Example:*

$n_{lo} = 1005$  r/min  
 $n_{hi} = 2385$  r/min  
 $f_{nrefA} = 0.25 \cdot (2385 - 1005) + 1005$   
 $f_{nrefB} = 0.50 \cdot (2385 - 1005) + 1005$   
 $f_{nrefC} = 0.75 \cdot (2385 - 1005) + 1005$   
 $f_{nrefD} = 0.15 \cdot (2385 - 1005) + 1005$   
 $f_{nrefA} = 1350$  r/min  
 $f_{nrefB} = 1695$  r/min  
 $f_{nrefC} = 2040$  r/min  
 $f_{nrefD} = 1212$  r/min  
 \* \* \* \* \*

■ 243. Amend § 1065.630 by revising paragraphs (a) and (b) introductory text to read as follows:

**§ 1065.630 Local acceleration of gravity.**

(a) The acceleration of Earth’s gravity,  $a_g$ , varies depending on the test location. Determine  $a_g$  at your location by entering latitude, longitude, and elevation data into the U.S. National Oceanographic and Atmospheric Administration’s surface gravity prediction website at [https://geodesy.noaa.gov/cgi-bin/grav\\_pdx.prl](https://geodesy.noaa.gov/cgi-bin/grav_pdx.prl).

(b) If the website specified in paragraph (a) of this section is unavailable, or the test location is outside of the continental United States, you may calculate  $a_g$  for your latitude as follows:

\* \* \* \* \*

■ 244. Amend § 1065.643 by revising paragraph (d) to read as follows:

**§ 1065.643 Carbon balance error verification calculations.**

\* \* \* \* \*

(d) *Carbon balance error quantities.* Calculate carbon balance error quantities as follows:

(1) Calculate carbon mass absolute error,  $\epsilon_{aC}$ , for a test interval as follows:

$$\epsilon_{aC} = m_{Cexh} - m_{Cfluid} - m_{Cair}$$

Eq. 1065.643-7

Where:

$m_{Cexh}$  = mass of carbon in exhaust emissions over the test interval as determined in paragraph (d) of this section.

$m_{Cfluid}$  = mass of carbon in all the carbon-carrying fluid streams flowing into the system over the test interval as determined in paragraph (a) of this section.

$m_{Cair}$  = mass of carbon in the intake air flowing into the system over the test interval as determined in paragraph (b) of this section.

*Example:*

$m_{Cexh} = 1247.2$  g  
 $m_{Cfluid} = 975.3$  g  
 $m_{Cair} = 278.6$  g  
 $\epsilon_{aC} = 1247.2 - 975.3 - 278.6$   
 $\epsilon_{aC} = -6.7$  g

(2) Calculate carbon mass rate absolute error,  $\epsilon_{aCrate}$ , for a test interval as follows:

$$\epsilon_{aCrate} = \frac{\epsilon_{aC}}{t}$$

Eq. 1065.643-8

Where:

$t$  = duration of the test interval.

*Example:*

$\epsilon_{aC} = -6.7$  g  
 $t = 1202.2$  s = 0.3339 hr

$$\epsilon_{aCrate} = \frac{-6.7}{0.3339}$$

$\epsilon_{aCrate} = -20.065$  g/hr

(3) Calculate carbon mass relative error,  $\epsilon_{rC}$ , for a test interval as follows:

$$\epsilon_{rC} = \frac{\epsilon_{aC}}{m_{Cfluid} + m_{Cair}}$$

Eq. 1065.643-9

*Example:*

$\epsilon_{aC} = -6.7$  g  
 $m_{Cfluid} = 975.3$  g  
 $m_{Cair} = 278.6$  g

$$\epsilon_{rC} = \frac{-6.7}{975.3 + 278.6}$$

$\epsilon_{rC} = -0.0053$

(4) Calculate composite carbon mass relative error,  $\epsilon_{rCcomp}$ , for a duty cycle with multiple test intervals as follows:

(i) Calculate  $\epsilon_{rCcomp}$  using the following equation:

$$\epsilon_{rCcomp} = \frac{\sum_{i=1}^N WF_i \cdot \frac{(m_{Cexhi} - m_{Cfluidi} - m_{Cairi})}{t_i}}{\sum_{i=1}^N WF_i \cdot \frac{(m_{Cfluidi} + m_{Cairi})}{t_i}}$$

Eq. 1065.643-10

Where:

*i* = an indexing variable that represents one test interval.

*N* = number of test intervals.

*WF* = weighting factor for the test interval as defined in the standard-setting part.

*m<sub>Cexh</sub>* = mass of carbon in exhaust emissions over the test interval as determined in paragraph (c) of this section.

*m<sub>Cfluid</sub>* = mass of carbon in all the carbon-carrying fluid streams that flowed into the system over the test interval as determined in paragraph (a) of this section.

*m<sub>Cair</sub>* = mass of carbon in the intake air that flowed into the system over the test interval as determined in paragraph (b) of this section.

*t* = duration of the test interval. For duty cycles with multiple test intervals of a prescribed duration, such as cold-start and hot-start transient cycles, set *t* = 1 for all test intervals. For discrete-mode steady-state duty cycles with multiple test intervals of varying duration, set *t* equal to the actual duration of each test interval.

(ii) The following example illustrates calculation of  $\epsilon_{rCcomp}$  for cold-start and hot-start transient cycles:

*N* = 2  
*WF*<sub>1</sub> = 1/7  
*WF*<sub>2</sub> = 6/7  
*m<sub>Cexh1</sub>* = 1255.3 g  
*m<sub>Cexh2</sub>* = 1247.2 g  
*m<sub>Cfluid1</sub>* = 977.8 g  
*m<sub>Cfluid2</sub>* = 975.3 g  
*m<sub>Cair1</sub>* = 280.2 g  
*m<sub>Cair2</sub>* = 278.6 g

$$\epsilon_{rCcomp} = \frac{\frac{1}{7} \cdot \frac{(1255.3 - 977.8 - 280.2)}{1} + \frac{6}{7} \cdot \frac{(1247.2 - 975.3 - 278.6)}{1}}{\frac{1}{7} \cdot \frac{(977.8 + 280.2)}{1} + \frac{6}{7} \cdot \frac{(975.3 + 278.6)}{1}}$$

$\epsilon_{rCcomp} = -0.0049$

(iii) The following example illustrates calculation of  $\epsilon_{rCcomp}$  for multiple test intervals with varying duration, such as discrete-mode steady-state duty cycles:

*N* = 2  
*WF*<sub>1</sub> = 0.85  
*WF*<sub>2</sub> = 0.15  
*m<sub>Cexh1</sub>* = 2.873 g  
*m<sub>Cexh2</sub>* = 0.125 g  
*m<sub>Cfluid1</sub>* = 2.864 g

*m<sub>Cfluid2</sub>* = 0.095 g  
*m<sub>Cair1</sub>* = 0.023 g  
*m<sub>Cair2</sub>* = 0.024 g  
*t*<sub>1</sub> = 123 s  
*t*<sub>2</sub> = 306 s

$$\epsilon_{rCcomp} = \frac{0.85 \cdot \left( \frac{2.873 - 2.864 - 0.023}{123} \right) + 0.15 \cdot \left( \frac{0.125 - 0.095 - 0.024}{306} \right)}{0.85 \cdot \left( \frac{2.864 + 0.023}{123} \right) + 0.15 \cdot \left( \frac{0.095 + 0.024}{306} \right)}$$

$\epsilon_{rCcomp} = -0.0047$

■ 245. Amend § 1065.650 by revising paragraphs (a), (c)(2)(i), (c)(3), (c)(4)(i), (c)(6), (d)(7), (e)(1) and (2), (f)(1) and (2), and (g)(1) and (2) to read as follows:

**§ 1065.650 Emission calculations.**

(a) *General.* Calculate brake-specific emissions over each applicable duty cycle or test interval. For test intervals with zero work (or power), calculate the emission mass (or mass rate), but do not calculate brake-specific emissions. Unless specified otherwise, for the purposes of calculating and reporting emission mass (or mass rate), do not alter any negative values of measured or calculated quantities. You may truncate negative values in chemical balance quantities listed in § 1065.655(c) to facilitate convergence. For duty cycles with multiple test intervals, refer to the standard-setting part for calculations you need to determine a composite

result, such as a calculation that weights and sums the results of individual test intervals in a duty cycle. If the standard-setting part does not include those calculations, use the equations in paragraph (g) of this section. This section is written based on rectangular integration, where each indexed value (*i.e.*, “*i*”) represents (or approximates) the mean value of the parameter for its respective time interval, delta-*t*. You may also integrate continuous signals using trapezoidal integration consistent with good engineering judgment.

\* \* \* \* \*  
 (c) \* \* \*  
 (2) \* \* \*

(i) *Varying flow rate.* If you continuously sample from a varying exhaust flow rate, time align and then multiply concentration measurements by the flow rate from which you extracted it. We consider the following to be examples of varying flows that

require a continuous multiplication of concentration times molar flow rate: raw exhaust, exhaust diluted with a constant flow rate of dilution air, and CVS dilution with a CVS flow meter that does not have an upstream heat exchanger or electronic flow control. This multiplication results in the flow rate of the emission itself. Integrate the emission flow rate over a test interval to determine the total emission. If the total emission is a molar quantity, convert this quantity to a mass by multiplying it by its molar mass, *M*. The result is the mass of the emission, *m*. Calculate *m* for continuous sampling with variable flow using the following equations:

$$m = M \cdot \sum_{i=1}^N x_i \cdot \dot{n}_i \cdot \Delta t$$

Eq. 1065.650-4

Where:

$$\Delta t = 1/f_{\text{record}}$$

Eq. 1065.650-5

Example:

$$M_{\text{NMHC}} = 13.875389 \text{ g/mol}$$

$$N = 1200$$

$$x_{\text{NMHC1}} = 84.5 \text{ } \mu\text{mol/mol} = 84.5 \cdot 10^{-6} \text{ mol/mol}$$

$$x_{\text{NMHC2}} = 86.0 \text{ } \mu\text{mol/mol} = 86.0 \cdot 10^{-6} \text{ mol/mol}$$

$$\dot{n}_{\text{exh1}} = 2.876 \text{ mol/s}$$

$$\dot{n}_{\text{exh2}} = 2.224 \text{ mol/s}$$

$$f_{\text{record}} = 1 \text{ Hz}$$

Using Eq. 1065.650-5,

$$\Delta t = 1/1 = 1 \text{ s}$$

$$m_{\text{NMHC}} = 13.875389 \cdot (84.5 \cdot 10^{-6} \cdot 2.876 + 86.0 \cdot 10^{-6} \cdot 2.224 + \dots + x_{\text{NMHC1200}} \cdot \dot{n}_{\text{exh}}) \cdot 1$$

$$m_{\text{NMHC}} = 25.23 \text{ g}$$

\* \* \* \* \*

(3) *Batch sampling.* For batch sampling, the concentration is a single value from a proportionally extracted batch sample (such as a bag, filter, impinger, or cartridge). In this case, multiply the mean concentration of the batch sample by the total flow from which the sample was extracted. You may calculate total flow by integrating a varying flow rate or by determining the mean of a constant flow rate, as follows:

(i) *Varying flow rate.* If you collect a batch sample from a varying exhaust flow rate, extract a sample proportional to the varying exhaust flow rate. We consider the following to be examples of varying flows that require proportional sampling: raw exhaust, exhaust diluted with a constant flow rate of dilution air, and CVS dilution with a CVS flow meter that does not have an upstream heat exchanger or electronic flow control. Integrate the flow rate over a test interval to determine the total flow from which you extracted the proportional sample. Multiply the mean concentration of the batch sample by the total flow from which the sample was extracted to determine the total emission. If the total emission is a molar quantity, convert this quantity to a mass by multiplying it by its molar mass,  $M$ . The result is the total emission mass,  $m$ . In the case of PM emissions, where the mean PM concentration is already in units of mass per mole of exhaust, simply multiply it by the total flow. The result is the total mass of PM,  $m_{\text{PM}}$ . Calculate  $m$  for each constituent as follows:

(A) Calculate  $m$  for measuring gaseous emission constituents with sampling that results in a molar concentration,  $\bar{x}$ , using the following equation:

$$m = M \cdot \bar{x} \cdot \sum_{i=1}^N \dot{n}_i \cdot \Delta t$$

Eq. 1065.650-6

Example:

$$M_{\text{NOx}} = 46.0055 \text{ g/mol}$$

$$N = 9000$$

$$\bar{x} = 85.6 \text{ } \mu\text{mol/mol} = 85.6 \cdot 10^{-6} \text{ mol/mol}$$

$$\dot{n}_{\text{dexh1}} = 25.534 \text{ mol/s}$$

$$\dot{n}_{\text{dexh2}} = 26.950 \text{ mol/s}$$

$$f_{\text{record}} = 5 \text{ Hz}$$

Using Eq. 1065.650-5:

$$\Delta t = 1/5 = 0.2 \text{ s}$$

$$m_{\text{NOx}} = 46.0055 \cdot 85.6 \cdot 10^{-6} \cdot (25.534 + 26.950 + \dots + \dot{n}_{\text{exh9000}}) \cdot 0.2$$

$$m_{\text{NOx}} = 4.201 \text{ g}$$

(B) Calculate  $m$  for sampling PM or any other analysis of a batch sample that yields a mass per mole of exhaust,  $\bar{M}$ , using the following equation:

$$m = \bar{M} \cdot \sum_{i=1}^N \dot{n}_i \cdot \Delta t$$

Eq. 1065.650-7

(ii) *Proportional or constant flow rate.* If you batch sample from a constant exhaust flow rate, extract a sample at a proportional or constant flow rate. We consider the following to be examples of constant exhaust flows: CVS diluted exhaust with a CVS flow meter that has either an upstream heat exchanger, electronic flow control, or both. Determine the mean molar flow rate from which you extracted the sample. Multiply the mean concentration of the batch sample by the mean molar flow rate of the exhaust from which the sample was extracted to determine the total emission and multiply the result by the time of the test interval. If the total emission is a molar quantity, convert this quantity to a mass by multiplying it by its molar mass,  $M$ . The result is the total emission mass,  $m$ . In the case of PM emissions, where the mean PM concentration is already in units of mass per mole of exhaust, simply multiply it by the total flow, and the result is the total mass of PM,  $m_{\text{PM}}$ . Calculate  $m$  for each constituent as follows:

(A) Calculate  $m$  for measuring gaseous emission constituents with sampling that results in a molar concentration,  $\bar{x}$ , using the following equation:

$$m = M \cdot \bar{x} \cdot \bar{\dot{n}} \cdot \Delta t$$

Eq. 1065.650-8

(B) Calculate  $m$  for sampling PM or any other analysis of a batch sample that

yields a mass per mole of exhaust,  $\bar{M}$ , using the following equation:

$$m = \bar{M} \cdot \bar{\dot{n}} \cdot \Delta t$$

Eq. 1065.650-9

(C) The following example illustrates a calculation of  $m_{\text{PM}}$ :

$$\bar{M}_{\text{PM}} = 144.0 \text{ } \mu\text{g/mol} = 144.0 \cdot 10^{-6} \text{ g/mol}$$

$$\bar{\dot{n}}_{\text{dexh}} = 57.692 \text{ mol/s}$$

$$\Delta t = 1200 \text{ s}$$

$$m_{\text{PM}} = 144.0 \cdot 10^{-6} \cdot 57.692 \cdot 1200$$

$$m_{\text{PM}} = 9.9692 \text{ g}$$

(4) \* \* \*

(i) For sampling with a constant dilution ratio,  $DR$ , of diluted exhaust versus exhaust flow (e.g., secondary dilution for PM sampling), calculate  $m$  using the following equation:

$$m_{\text{PM}} = m_{\text{PMdil}} \cdot DR$$

Eq. 1065.650-10

Example:

$$m_{\text{PMdil}} = 6.853 \text{ g}$$

$$DR = 6:1$$

$$m_{\text{PM}} = 6.853 \cdot 6$$

$$m_{\text{PM}} = 41.118 \text{ g}$$

\* \* \* \* \*

(6) *Mass of NMNEHC.* Determine the mass of NMNEHC using one of the following methods:

(i) If the test fuel has less than 0.010 mol/mol of ethane and you omit the NMNEHC calculations as described in § 1065.660(c)(1), take the corrected mass of NMNEHC to be 0.95 times the corrected mass of NMHC.

(ii) If the test fuel has at least 0.010 mol/mol of ethane and you omit the NMNEHC calculations as described in § 1065.660(c)(1), take the corrected mass of NMNEHC to be 1.0 times the corrected mass of NMHC.

(d) \* \* \*

(7) Integrate the resulting values for power over the test interval. Calculate total work as follows:

$$W = \sum_{i=1}^N P_i \cdot \Delta t$$

Eq. 1065.650-11

Where:

$W$  = total work from the primary output shaft.  
 $P_i$  = instantaneous power from the primary output shaft over an interval  $i$ .

$$P_i = f_{ni} \cdot T_i$$

Eq. 1065.650-12

Example:

$$N = 9000$$

$$f_{n1} = 1800.2 \text{ r/min}$$

$$f_{n2} = 1805.8 \text{ r/min}$$

$$T_1 = 177.23 \text{ N}\cdot\text{m}$$

$$T_2 = 175.00 \text{ N}\cdot\text{m}$$

$$C_{\text{rev}} = 2\cdot\pi \text{ rad/r}$$

$$C_{i1} = 60 \text{ s/min}$$

$$C_p = 1000 \text{ (N}\cdot\text{m}\cdot\text{rad/s)/kW}$$

$$f_{\text{record}} = 5 \text{ Hz}$$

$$C_{i2} = 3600 \text{ s/hr}$$

$$P_1 = \frac{1800.2 \cdot 177.23 \cdot 2 \cdot 3.14159}{60 \cdot 1000}$$

$$P_1 = 33.41 \text{ kW}$$

$$P_2 = 33.09 \text{ kW}$$

$$\Delta t = 1/5 = 0.2 \text{ s}$$

Using Eq. 1065.650-5:

$$W = \frac{(33.41 + 33.09 + \dots + P_{9000}) \cdot 0.2}{3600}$$

$$W = 16.875 \text{ kW}\cdot\text{hr}$$

\* \* \* \* \*

(e) \* \* \*

(1) To calculate,  $\bar{m}$ , multiply its mean concentration,  $\bar{x}$ , by its corresponding mean molar flow rate,  $\bar{n}$ . If the result is a molar flow rate, convert this quantity to a mass rate by multiplying it by its molar mass,  $M$ . The result is the mean mass rate of the emission,  $\bar{m}$ . In the case of PM emissions, where the mean PM concentration is already in units of mass per mole of exhaust, simply multiply it by the mean molar flow rate,  $\bar{n}$ . The result is the mass rate of PM,  $\dot{m}_{\text{PM}}$ . Calculate  $\bar{m}$  using the following equation:

$$\bar{m} = M \cdot \bar{x} \cdot \bar{n}$$

Eq. 1065.650-13

(2) To calculate an engine's mean steady-state total power,  $\bar{P}$ , add the mean steady-state power from all the work paths described in § 1065.210 that cross the system boundary including electrical power, mechanical shaft power, and fluid pumping power. For all work paths, except the engine's primary output shaft (crankshaft), the mean steady-state power over the test interval is the integration of the net work flow rate (power) out of the system boundary divided by the period of the test interval. When power flows into the system boundary, the power/work flow rate signal becomes negative; in this case, include these negative power/work rate values in the integration to calculate the mean power from that work path. Some work paths may result in a negative mean power. Include negative mean power values from any work path in the mean total power from the engine rather than setting these values to zero. The rest of this paragraph (e)(2) describes how to calculate the mean power from the engine's primary output shaft. Calculate  $\bar{P}$  using Eq. 1065.650-13, noting that  $\bar{P}$ ,  $\bar{f}_n$ , and  $\bar{T}$  refer to mean power, mean rotational

shaft frequency, and mean torque from the primary output shaft. Account for the power of simulated accessories according to § 1065.110 (reducing the mean primary output shaft power or torque by the accessory power or torque). Set the power to zero during actual motoring operation (negative feedback torques), unless the engine was connected to one or more energy storage devices. Examples of such energy storage devices include hybrid powertrain batteries and hydraulic accumulators, like the ones denoted "Acc." and "Batt." as illustrated in Figure 1 of § 1065.210. Set the power to zero for modes with a zero reference load (0 N·m reference torque or 0 kW reference power). Include power during idle modes with simulated minimum torque or power.

$$\bar{P} = \bar{f}_n \cdot \bar{T}$$

Eq. 1065.650-14

\* \* \* \* \*

(f) \* \* \*

(1) *Total mass.* To determine a value proportional to the total mass of an emission, determine total mass as described in paragraph (c) of this section, except substitute for the molar flow rate,  $\dot{n}$ , or the total flow,  $n$ , with a signal that is linearly proportional to molar flow rate,  $\tilde{n}$ , or linearly proportional to total flow,  $\tilde{n}$ , as follows:

$$\tilde{m}_{\text{fuel}i} = \frac{1}{w_{\text{fuel}}} \cdot \frac{M_C \cdot \tilde{n}_i \cdot x_{\text{Ccomb}dryi}}{1 + x_{\text{H}_2\text{O}exhdryi}}$$

Eq. 1065.650-15

(2) *Total work.* To calculate a value proportional to total work over a test interval, integrate a value that is proportional to power. Use information about the brake-specific fuel consumption of your engine,  $e_{\text{fuel}}$ , to convert a signal proportional to fuel flow rate to a signal proportional to power. To determine a signal

proportional to fuel flow rate, divide a signal that is proportional to the mass rate of carbon products by the fraction of carbon in your fuel,  $w_C$ . You may use a measured  $w_C$  or you may use default values for a given fuel as described in § 1065.655(e). Calculate the mass rate of carbon from the amount of carbon and water in the exhaust, which you determine with a chemical balance of fuel, DEF, intake air, and exhaust as described in § 1065.655. In the chemical balance, you must use concentrations from the flow that generated the signal proportional to molar flow rate,  $\tilde{n}$ , in paragraph (e)(1) of this section. Calculate a value proportional to total work as follows:

$$W = \sum_{i=1}^N \tilde{P}_i \cdot \Delta t$$

Eq. 1065.650-16

Where:

$$\tilde{P}_i = \frac{\tilde{m}_{\text{fuel}i}}{e_{\text{fuel}}}$$

Eq. 1065.650-17

\* \* \* \* \*

(g) \* \* \*

(1) Use the following equation to calculate composite brake-specific emissions for duty cycles with multiple test intervals all with prescribed durations, such as cold-start and hot-start transient cycles:

$$e_{\text{comp}} = \frac{\sum_{i=1}^N WF_i \cdot m_i}{\sum_{i=1}^N WF_i \cdot W_i}$$

Eq. 1065.650-18

Where:

- $i$  = test interval number.
- $N$  = number of test intervals.
- $WF$  = weighting factor for the test interval as defined in the standard-setting part.

$m$  = mass of emissions over the test interval as determined in paragraph (c) of this section.  
 $W$  = total work from the engine over the test interval as determined in paragraph (d) of this section.

*Example:*  
 $N = 2$   
 $WF_1 = 0.1428$   
 $WF_2 = 0.8572$   
 $m_1 = 70.125$  g

$m_2 = 64.975$  g  
 $W_1 = 25.783$  kW·hr  
 $W_2 = 25.783$  kW·hr

$$e_{NO_x\text{comp}} = \frac{(0.1428 \cdot 70.125) + (0.8572 \cdot 64.975)}{(0.1428 \cdot 25.783) + (0.8572 \cdot 25.783)}$$

$e_{NO_x\text{comp}} = 2.548$  g/kW·hr

(2) Calculate composite brake-specific emissions for duty cycles with multiple test intervals that allow use of varying duration, such as discrete-mode steady-state duty cycles, as follows:

(i) Use the following equation if you calculate brake-specific emissions over test intervals based on total mass and total work as described in paragraph (b)(1) of this section:

$$e_{\text{comp}} = \frac{\sum_{i=1}^N WF_i \cdot \frac{m_i}{t_i}}{\sum_{i=1}^N WF_i \cdot \frac{W_i}{t_i}}$$

Eq. 1065.650-19

Where:  
 $i$  = test interval number.  
 $N$  = number of test intervals.  
 $WF$  = weighting factor for the test interval as defined in the standard-setting part.  
 $m$  = mass of emissions over the test interval as determined in paragraph (c) of this section.

$W$  = total work from the engine over the test interval as determined in paragraph (d) of this section.  
 $t$  = duration of the test interval.

*Example:*

$N = 2$   
 $WF_1 = 0.85$   
 $WF_2 = 0.15$   
 $m_1 = 1.3753$  g  
 $m_2 = 0.4135$  g  
 $t_1 = 120$  s  
 $t_2 = 200$  s  
 $W_1 = 2.8375$  kW · hr  
 $W_2 = 0.0$  kW · hr

$$e_{NO_x\text{comp}} = \frac{\left(0.85 \cdot \frac{1.3753}{120}\right) + \left(0.15 \cdot \frac{0.4135}{200}\right)}{\left(0.85 \cdot \frac{2.8375}{120}\right) + \left(0.15 \cdot \frac{0.0}{200}\right)}$$

$e_{NO_x\text{comp}} = 0.5001$  g/kW·hr

(ii) Use the following equation if you calculate brake-specific emissions over test intervals based on the ratio of mass rate to power as described in paragraph (b)(2) of this section:

$$e_{\text{comp}} = \frac{\sum_{i=1}^N WF_i \cdot \bar{m}_i}{\sum_{i=1}^N WF_i \cdot \bar{P}_i}$$

Eq. 1065.650-20

Where:  
 $i$  = test interval number.  
 $N$  = number of test intervals.  
 $WF$  = weighting factor for the test interval as defined in the standard-setting part.  
 $\bar{m}$  = mean steady-state mass rate of emissions over the test interval as determined in paragraph (e) of this section.  
 $\bar{P}$  = mean steady-state power over the test interval as described in paragraph (e) of this section.

*Example:*

$N = 2$   
 $WF_1 = 0.85$   
 $WF_2 = 0.15$   
 $\bar{m}_1 = 2.25842$  g/hr  
 $\bar{m}_2 = 0.063443$  g/hr  
 $\bar{P}_1 = 4.5383$  kW  
 $\bar{P}_2 = 0.0$  kW

$$e_{NO_x\text{comp}} = \frac{(0.85 \cdot 2.25842) + (0.15 \cdot 0.063443)}{(0.85 \cdot 4.5383) + (0.15 \cdot 0.0)}$$

$e_{NO_x\text{comp}} = 0.5001$  g/kW·hr

\* \* \* \* \*

■ 246. Amend § 1065.655 by revising paragraphs (c) introductory text, (e)(1)(i), (e)(4), and (f)(3) to read as follows:

**§ 1065.655 Chemical balances of fuel, DEF, intake air, and exhaust.**

\* \* \* \* \*

(c) *Chemical balance procedure.* The calculations for a chemical balance involve a system of equations that require iteration. We recommend using a computer to solve this system of

equations. You must guess the initial values of up to three quantities: the amount of water in the measured flow,  $x_{H_2O\text{exh}}$ , fraction of dilution air in diluted exhaust,  $x_{\text{dil/exh}}$ , and the amount of products on a  $C_1$  basis per dry mole of dry measured flow,  $x_{\text{Ccombdry}}$ . You may use time-weighted mean values of intake air humidity and dilution air humidity in the chemical balance; as long as your intake air and dilution air humidities remain within tolerances of  $\pm 0.0025$  mol/mol of their respective mean values over the test interval. For each emission concentration,  $x$ , and

amount of water,  $x_{H_2O\text{exh}}$ , you must determine their completely dry concentrations,  $x_{\text{dry}}$  and  $x_{H_2O\text{exhdry}}$ . You must also use your fuel mixture's atomic hydrogen-to-carbon ratio,  $\alpha$ , oxygen-to-carbon ratio,  $\beta$ , sulfur-to-carbon ratio,  $\gamma$ , and nitrogen-to-carbon ratio,  $\delta$ ; you may optionally account for diesel exhaust fluid (or other fluids injected into the exhaust), if applicable. You may calculate  $\alpha$ ,  $\beta$ ,  $\gamma$ , and  $\delta$  based on measured fuel composition or based on measured fuel and diesel exhaust fluid (or other fluids injected into the exhaust) composition together, as

described in paragraph (e) of this section. You may alternatively use any combination of default values and measured values as described in paragraph (e) of this section. Use the following steps to complete a chemical balance:

\* \* \* \* \*

(e) \* \* \*

(1) \* \* \*

(i) Determine the carbon and hydrogen mass fractions according to ASTM D5291 (incorporated by reference

in § 1065.1010). When using ASTM D5291 to determine carbon and hydrogen mass fractions of gasoline (with or without blended ethanol), use good engineering judgment to adapt the method as appropriate. This may include consulting with the instrument manufacturer on how to test high-volatility fuels. Allow the weight of volatile fuel samples to stabilize for 20 minutes before starting the analysis; if the weight still drifts after 20 minutes, prepare a new sample). Retest the

sample if the carbon, hydrogen, oxygen, sulfur, and nitrogen mass fractions do not add up to a total mass of  $100 \pm 0.5\%$ ; you may assume oxygen has a zero mass contribution for this specification for diesel fuel and neat (E0) gasoline. You may also assume that sulfur and nitrogen have a zero mass contribution for this specification for all fuels except residual fuel blends.

\* \* \* \* \*

(4) Calculate  $\alpha$ ,  $\beta$ ,  $\gamma$ , and  $\delta$  using the following equations:

$$\alpha = \frac{M_C}{M_H} \cdot \frac{\sum_{j=1}^N \dot{m}_j \cdot w_{Hj}}{\sum_{j=1}^N \dot{m}_j \cdot w_{Cj}} \quad \text{Eq. 1065.655-20}$$

$$\beta = \frac{M_C}{M_O} \cdot \frac{\sum_{j=1}^N \dot{m}_j \cdot w_{Oj}}{\sum_{j=1}^N \dot{m}_j \cdot w_{Cj}} \quad \text{Eq. 1065.655-21}$$

$$\gamma = \frac{M_C}{M_S} \cdot \frac{\sum_{j=1}^N \dot{m}_j \cdot w_{Sj}}{\sum_{j=1}^N \dot{m}_j \cdot w_{Cj}} \quad \text{Eq. 1065.655-22}$$

$$\delta = \frac{M_C}{M_N} \cdot \frac{\sum_{j=1}^N \dot{m}_j \cdot w_{Nj}}{\sum_{j=1}^N \dot{m}_j \cdot w_{Cj}} \quad \text{Eq. 1065.655-23}$$

Where:

$N$  = total number of fuels and injected fluids over the duty cycle.

$j$  = an indexing variable that represents one fuel or injected fluid, starting with  $j = 1$ .

$\dot{m}_j$  = the mass flow rate of the fuel or any injected fluid  $j$ . For applications using a single fuel and no DEF fluid, set this value to 1. For batch measurements, divide the total mass of fuel over the test interval duration to determine a mass rate.

$w_{Hj}$  = hydrogen mass fraction of fuel or any injected fluid  $j$ .

$w_{Cj}$  = carbon mass fraction of fuel or any injected fluid  $j$ .

$w_{Oj}$  = oxygen mass fraction of fuel or any injected fluid  $j$ .

$w_{Sj}$  = sulfur mass fraction of fuel or any injected fluid  $j$ .

$w_{Nj}$  = nitrogen mass fraction of fuel or any injected fluid  $j$ .

Example:

$N = 1$

$j = 1$

$\dot{m}_1 = 1$

$w_{H1} = 0.1239$

$w_{C1} = 0.8206$

$w_{O1} = 0.0547$

$w_{S1} = 0.00066$

$w_{N1} = 0.000095$

$M_C = 12.0107$  g/mol

$M_H = 1.00794$  g/mol

$M_O = 15.9994$  g/mol

$M_S = 32.065$  g/mol

$M_N = 14.0067$

$$\alpha = \frac{12.0107 \cdot 1 \cdot 0.1239}{1.00794 \cdot 1 \cdot 0.8206}$$

$$\beta = \frac{15.9994 \cdot 1 \cdot 0.8206}{12.0107 \cdot 1 \cdot 0.00066}$$

$$\gamma = \frac{32.065 \cdot 1 \cdot 0.8206}{12.0107 \cdot 1 \cdot 0.000095}$$

$$\delta = \frac{14.0067 \cdot 1 \cdot 0.8206}{14.0067 \cdot 1 \cdot 0.8206}$$

$$\alpha = 1.799$$

$\alpha = 1.799$

$\beta = 0.05004$

$\gamma = 0.0003012$

$\delta = 0.0001003$

\* \* \* \* \*

(f) \* \* \*

(3) *Fluid mass flow rate calculation.* This calculation may be used only for steady-state laboratory testing. You may not use this calculation if the standard-setting part requires carbon balance error verification as described in § 1065.543. See § 1065.915(d)(5)(iv) for application to field testing. Calculate  $\dot{n}_{\text{exh}}$  based on  $\dot{m}_j$  using the following equation:

$$\dot{n}_{\text{exh}} = \frac{1 + x_{\text{H}_2\text{Oexhdry}}}{M_C \cdot x_{\text{Ccombdry}}} \cdot \sum_{j=1}^N \dot{m}_j \cdot w_{Cj}$$

Where:

$\dot{n}_{\text{exh}}$  = raw exhaust molar flow rate from which you measured emissions.  
 $j$  = an indexing variable that represents one fuel or injected fluid, starting with  $j = 1$ .  
 $N$  = total number of fuels and injected fluids over the duty cycle.

$\dot{m}_j$  = the mass flow rate of the fuel or any injected fluid  $j$ .  
 $w_{Cj}$  = carbon mass fraction of the fuel and any injected fluid  $j$ .  
**Example:**  
 $N = 1$   
 $j = 1$

$\dot{m}_1 = 7.559 \text{ g/s}$   
 $w_{C1} = 0.869 \text{ g/g}$   
 $M_C = 12.0107 \text{ g/mol}$   
 $X_{C\text{combdry}1} = 99.87 \text{ mmol/mol} = 0.09987 \text{ mol/mol}$   
 $X_{H2O\text{exhdry}1} = 107.64 \text{ mmol/mol} = 0.10764 \text{ mol/mol}$

$$\dot{n}_{\text{exh}} = \frac{1 + 0.10764}{12.0107 \cdot 0.09987} \cdot 7.559 \cdot 0.869$$

$n_{\text{exh}} = 6.066 \text{ mol/s}$   
 \* \* \* \* \*

■ 247. Amend § 1065.660 by revising paragraphs (b)(2)(i) introductory text, (c)(1), and (d)(1)(i) introductory text to read as follows:

**§ 1065.660 THC, NMHC, NMNEHC, CH<sub>4</sub>, and C<sub>2</sub>H<sub>6</sub> determination.**

\* \* \* \* \*

(b) \* \* \*  
 (2) \* \* \*

(i) If you need to account for penetration fractions determined as a function of molar water concentration, use Eq. 1065.660–4. Otherwise, use the following equation for penetration fractions determined using an NMC configuration as outlined in § 1065.365(d):

\* \* \* \* \*

(c) \* \* \*

(1) Calculate  $X_{NMNEHC}$  based on the test fuel’s ethane content as follows:  
 (i) If the content of your test fuel contains less than 0.010 mol/mol of ethane, you may omit the calculation of NMNEHC concentration and calculate the mass of NMNEHC as described in § 1065.650(c)(6)(i).

(ii) If the content of your fuel test contains at least 0.010 mol/mol of ethane, you may omit the calculation of NMNEHC concentration and calculate the mass of NMNEHC as described in § 1065.650(c)(6)(ii).

\* \* \* \* \*

(d) \* \* \*

(1) \* \* \*

(i) If you need to account for penetration fractions determined as a function of molar water concentration, use Eq. 1065.660–11. Otherwise, use the following equation for penetration fractions determined using an NMC configuration as outlined in § 1065.365(d):

\* \* \* \* \*

■ 248. Amend § 1065.667 by revising paragraph (a) to read as follows:

**§ 1065.667 Dilution air background emission correction.**

(a) To determine the mass of background emissions to subtract from a

diluted exhaust sample, first determine the total flow of dilution air,  $n_{\text{dil}}$ , over the test interval. This may be a measured quantity or a calculated quantity. Multiply the total flow of dilution air by the mean mole fraction (*i.e.*, concentration) of a background emission. This may be a time-weighted mean or a flow-weighted mean (*e.g.*, a proportionally sampled background). Finally, multiply by the molar mass,  $M$ , of the associated gaseous emission constituent. The product of  $n_{\text{dil}}$  and the mean molar concentration of a background emission and its molar mass,  $M$ , is the total background emission mass,  $m$ . In the case of PM, where the mean PM concentration is already in units of mass per mole of exhaust, multiply it by the total amount of dilution air flow, and the result is the total background mass of PM,  $m_{\text{PM}}$ . Subtract total background mass from total mass to correct for background emissions.

\* \* \* \* \*

■ 249. Amend § 1065.670 by revising the introductory text to read as follows:

**§ 1065.670 NO<sub>x</sub> intake-air humidity and temperature corrections.**

See the standard-setting part to determine if you may correct NO<sub>x</sub> emissions for the effects of intake-air humidity or temperature. Use the NO<sub>x</sub> intake-air humidity and temperature corrections specified in the standard-setting part instead of the NO<sub>x</sub> intake-air humidity correction specified in this part 1065. If the standard-setting part does not prohibit correcting NO<sub>x</sub> emissions for intake-air humidity according to this part 1065, correct NO<sub>x</sub> concentrations for intake-air humidity as described in this section. See § 1065.650(c)(1) for the proper sequence for applying the NO<sub>x</sub> intake-air humidity and temperature corrections. You may use a time-weighted mean intake air humidity to calculate this correction if your intake air humidity remains within a tolerance of ±0.0025 mol/mol of the mean value over the test interval. For intake-air humidity

correction, use one of the following approaches:

\* \* \* \* \*

■ 250. Amend § 1065.672 by revising paragraphs (d)(3) and (4) to read as follows:

**§ 1065.672 Drift correction.**

\* \* \* \* \*

(d) \* \* \*

(3) For any pre-test interval concentrations, use the last concentration determined before the test interval. For some test intervals, the last pre-zero or pre-span might have occurred before one or more earlier test intervals.

(4) For any post-test interval concentrations, use the first concentration determined after the test interval. For some test intervals, the first post-zero or post-span might occur after one or more later test intervals.

\* \* \* \* \*

■ 251. Amend § 1065.675 by revising paragraph (b) to read as follows:

**§ 1065.675 CLD quench verification calculations.**

\* \* \* \* \*

(b) Estimate the maximum expected mole fraction of water during emission testing,  $X_{H2O\text{exp}}$ . Make this estimate where the humidified NO span gas was introduced in § 1065.370(e)(6). When estimating the maximum expected mole fraction of water, consider the maximum expected water content in intake air, fuel combustion products, and dilution air (if applicable). If you introduced the humidified NO span gas into the sample system upstream of a sample dryer during the verification test, you need not estimate the maximum expected mole fraction of water and you must set  $X_{H2O\text{exp}}$  equal to  $X_{H2O\text{meas}}$ .

\* \* \* \* \*

■ 252. Amend § 1065.680 by revising the introductory text to read as follows:

**§ 1065.680 Adjusting emission levels to account for infrequently regenerating aftertreatment devices.**

This section describes how to calculate and apply emission adjustment factors for engines using aftertreatment technology with infrequent regeneration events that may occur during testing. These adjustment factors are typically calculated based on measurements conducted for the purposes of engine certification, and then used to adjust the results of testing related to demonstrating compliance with emission standards. For this section, “regeneration” means an intended event during which emission levels change while the system restores aftertreatment performance. For example, exhaust gas temperatures may increase temporarily to remove sulfur from an adsorber or SCR catalyst or to oxidize accumulated particulate matter in a trap. The duration of this event extends until the aftertreatment performance and emission levels have returned to normal baseline levels. Also,

“infrequent” refers to regeneration events that are expected to occur on average less than once over a transient or ramped-modal duty cycle, or on average less than once per mode in a discrete-mode test.

\* \* \* \* \*

■ 253. Amend § 1065.695 by revising paragraphs (a) and (c)(12)(ix) to read as follows:

**§ 1065.695 Data requirements.**

(a) To determine the information we require from engine tests, refer to the standard-setting part and request from your EPA Program Officer the format used to apply for certification or demonstrate compliance. We may require different information for different purposes, such as for certification applications, approval requests for alternate procedures, selective enforcement audits, laboratory audits, production-line test reports, and field-test reports.

\* \* \* \* \*

(c) \* \* \*

(12) \* \* \*  
(ix) Warm idle speed value, any enhanced-idle speed value.

\* \* \* \* \*

■ 254. Amend § 1065.715 by revising paragraph (b)(3) to read as follows:

**§ 1065.715 Natural gas.**

\* \* \* \* \*

(b) \* \* \*

(3) You may ask for approval to use fuel that does not meet the specifications in paragraph (a) of this section, but only if using the fuel would not adversely affect your ability to demonstrate compliance with the applicable standards in this chapter.

\* \* \* \* \*

■ 255. Amend § 1065.720 by revising paragraphs (a) and (b)(3) to read as follows:

**§ 1065.720 Liquefied petroleum gas.**

(a) Except as specified in paragraph (b) of this section, liquefied petroleum gas for testing must meet the specifications in the following table:

TABLE 1 TO PARAGRAPH (a) OF § 1065.720—TEST FUEL SPECIFICATIONS FOR LIQUEFIED PETROLEUM GAS

Property	Value	Reference procedure <sup>a</sup>
Propane, C <sub>3</sub> H <sub>8</sub> .....	Minimum, 0.85 m <sup>3</sup> /m <sup>3</sup> .....	ASTM D2163.
Vapor pressure at 38°C .....	Maximum, 1400 kPa .....	ASTM D1267 or ASTM D2598 <sup>b</sup> .
Butanes .....	Maximum, 0.05 m <sup>3</sup> /m <sup>3</sup> .....	ASTM D2163.
Butenes .....	Maximum, 0.02 m <sup>3</sup> /m <sup>3</sup> .....	ASTM D2163.
Pentenes and heavier .....	Maximum, 0.005 m <sup>3</sup> /m <sup>3</sup> .....	ASTM D2163.
Propene .....	Maximum, 0.1 m <sup>3</sup> /m <sup>3</sup> .....	ASTM D2163.
Residual matter (residue on evaporation of 100 ml oil stain observation).	Maximum, 0.05 ml pass <sup>c</sup> .....	ASTM D2158.
Corrosion, copper strip .....	Maximum, No. 1 .....	ASTM D1838.
Sulfur .....	Maximum, 80 mg/kg .....	ASTM D6667.
Moisture content .....	pass .....	ASTM D2713.

<sup>a</sup> Incorporated by reference; see § 1065.1010. See § 1065.701(d) for other allowed procedures.

<sup>b</sup> If these two test methods yield different results, use the results from ASTM D1267.

<sup>c</sup> The test fuel must not yield a persistent oil ring when you add 0.3 ml of solvent residue mixture to a filter paper in 0.1 ml increments and examine it in daylight after two minutes.

(b) \* \* \*

(3) You may ask for approval to use fuel that does not meet the specifications in paragraph (a) of this section, but only if using the fuel would not adversely affect your ability to demonstrate compliance with the applicable standards in this chapter.

\* \* \* \* \*

■ 256. Revise § 1065.790 to read as follows:

**§ 1065.790 Mass standards.**

(a) *PM balance calibration weights.* Use PM balance calibration weights that are certified as NIST-traceable within ±0.1% uncertainty. Make sure your highest calibration weight has no more than ten times the mass of an unused PM-sample medium.

(b) *Dynamometer, fuel mass scale, and DEF mass scale calibration weights.*

Use dynamometer and mass scale calibration weights that are certified as NIST-traceable within ±0.1% uncertainty.

■ 257. Amend § 1065.901 by revising paragraphs (a) and (b)(3) to read as follows:

**§ 1065.901 Applicability.**

(a) *Field testing.* This subpart specifies procedures for field-testing engines to determine brake-specific emissions and mass rate emissions using portable emission measurement systems (PEMS). These procedures are designed primarily for in-field measurements of engines that remain installed in vehicles or equipment the

field. Field-test procedures apply to your engines only as specified in the standard-setting part.

(b) \* \* \*

(3) Do not use PEMS for laboratory measurements if it prevents you from demonstrating compliance with the applicable standards in this chapter. Some of the PEMS requirements in this part 1065 are less stringent than the corresponding laboratory requirements. Depending on actual PEMS performance, you might therefore need to account for some additional measurement uncertainty when using PEMS for laboratory testing. If we ask, you must show us by engineering analysis that any additional measurement uncertainty due to your use of PEMS for laboratory testing is



offset by the extent to which your engine's emissions are below the applicable standards in this chapter. For example, you might show that PEMS versus laboratory uncertainty represents 5% of the standard, but your engine's deteriorated emissions are at least 20% below the standard for each pollutant.

■ 258. Amend § 1065.910 by revising paragraphs (b) and (d)(2) to read as follows:

**§ 1065.910 PEMS auxiliary equipment for field testing.**

\* \* \* \* \*

(b) Locate the PEMS to minimize the effects of the following parameters or place the PEMS in an environmental enclosure that minimizes the effect of these parameters on the emission measurement:

- (1) Ambient temperature changes.
(2) Electromagnetic radiation.
(3) Mechanical shock and vibration.

\* \* \* \* \*

(d) \* \* \*

(2) You may install your own portable power supply. For example, you may use batteries, fuel cells, a portable generator, or any other power supply to supplement or replace your use of vehicle power. You may connect an external power source directly to the vehicle's, vessel's, or equipment's power system; however, you must not supply power to the vehicle's power system in excess of 1% of the engine's maximum power.

■ 259. Amend § 1065.915 by revising paragraph (d)(6) to read as follows:

**§ 1065.915 PEMS instruments.**

\* \* \* \* \*

(d) \* \* \*

(6) Permissible deviations. ECM signals may deviate from the specifications of this part 1065, but the expected deviation must not prevent you from demonstrating that you meet the applicable standards in this chapter. For example, your emission results may be sufficiently below an applicable standard, such that the deviation would not significantly change the result. As another example, a very low engine-coolant temperature may define a logical statement that determines when a test interval may start. In this case, even if the ECM's sensor for detecting coolant temperature was not very accurate or repeatable, its output would never deviate so far as to significantly affect when a test interval may start.

■ 260. Amend § 1065.920 by:

- a. Revising paragraphs (b)(2), (b)(4) introductory text, and (b)(4)(iii).
■ b. Removing paragraph (b)(5).
■ c. Redesignating paragraphs (b)(6) and (7) as (b)(5) and (6), respectively.

■ d. Revising newly redesignated paragraph (b)(6)(ii).

The revisions read as follows:

**§ 1065.920 PEMS calibrations and verifications.**

\* \* \* \* \*

(b) \* \* \*

(2) Select or create a duty cycle that has all the following characteristics:

(i) Engine operation that represents normal in-use speeds, loads, and degree of transient activity. Consider using data from previous field tests to generate a cycle.

(ii) A duration of (6 to 9) hours.

\* \* \* \* \*

(4) Determine the brake-specific emissions and mass rate emissions, as applicable, for each test interval for both laboratory and the PEMS measurements, as follows:

\* \* \* \* \*

(iii) If the standard-setting part specifies the use of a measurement allowance for field testing, also apply the measurement allowance during calibration using good engineering judgment. If the measurement allowance is normally added to the standard, this means you must subtract the measurement allowance from measured PEMS emission results.

\* \* \* \* \*

(6) \* \* \*

(ii) The entire set of test-interval results passes the 95% confidence alternate-procedure statistics for field testing (t-test and F-test) specified in § 1065.12.

■ 261. Amend § 1065.935 by revising paragraphs (d)(4) and (g) to read as follows:

**§ 1065.935 Emission test sequence for field testing.**

\* \* \* \* \*

(d) \* \* \*

(4) Conduct periodic verifications such as zero and span verifications on PEMS gas analyzers and use these to correct for drift according to paragraph (g) of this section. Do not include data recorded during verifications in emission calculations. Conduct the verifications as follows:

(i) For PEMS gas analyzers used to determine NTE emission values, perform verifications as recommended by the PEMS manufacturer or as indicated by good engineering judgment.

(ii) For PEMS gas analyzers used to determine bin emission values, perform zero verifications at least hourly using purified air. Perform span verification at the end of the shift-day or more frequently as recommended by the

PEMS manufacturer or as indicated by good engineering judgment.

\* \* \* \* \*

(g) Take the following steps after emission sampling is complete:

(1) As soon as practical after emission sampling, analyze any gaseous batch samples.

(2) If you used dilution air, either analyze background samples or assume that background emissions were zero. Refer to § 1065.140 for dilution-air specifications.

(3) After quantifying all exhaust gases, record mean analyzer values after stabilizing a zero gas to each analyzer, then record mean analyzer values after stabilizing the span gas to the analyzer. Stabilization may include time to purge an analyzer of any sample gas and any additional time to account for analyzer response. Use these recorded values, including pre-test verifications and any zero verifications during testing, to correct for drift as described in § 1065.550.

(4) Verify PEMS gas analyzers used to determine NTE emission values as follows:

(i) Invalidate any data that does not meet the range criteria in § 1065.550. Note that it is acceptable that analyzers exceed 100% of their ranges when measuring emissions between test intervals, but not during test intervals. You do not have to retest an engine if the range criteria are not met.

(ii) Invalidate any data that does not meet the drift criterion in § 1065.550. For HC, invalidate any data if the difference between the uncorrected and the corrected brake-specific HC emission values are not within ±10% of the uncorrected results or the applicable standard, whichever is greater. For data that does meet the drift criterion, correct those test intervals for drift according to § 1065.672 and use the drift corrected results in emissions calculations.

(5) Verify PEMS gas analyzers used to determine bin emission values as follows:

(i) Invalidate data from a whole shift-day if more than 1% of recorded 1 Hz data exceeds 100% of the selected gas analyzer range. For analyzer outputs exceeding 100% of range, calculate emission results using the reported value. You must retest an engine if the range criteria are not met.

(ii) Invalidate any data for periods in which the CO and CO2 gas analyzers do not meet the drift criterion in § 1065.550. For HC, invalidate data if the difference between the uncorrected and the corrected brake-specific HC emission values are not within ±10% of the uncorrected results or the applicable

standard, whichever is greater. For data that do meet the drift criterion, correct the data for drift according to § 1065.672 and use the drift-corrected results in emissions calculations.

(iii) For PEMS NO<sub>x</sub> analyzers used to determine bin emission values, invalidate data for the engine over the entire shift-day if any data do not meet the following drift limits instead of meeting the drift criteria specified in § 1065.550:

(A) The allowable analyzer zero-drift between successive zero verifications is ±2.5 ppm. The analyzer zero-drift limit over the shift-day is ±10 ppm.

(B) The allowable analyzer span-drift limit is ±4% of the measured span value between successive span verifications.

(6) Unless you weighed PM in-situ, such as by using an inertial PM balance, place any used PM samples into covered or sealed containers and return them to the PM-stabilization environment and weigh them as described in § 1065.595.

■ 262. Amend § 1065.1001 by:

■ a. Removing the definition of “Designated Compliance Officer”.

■ b. Adding definitions of “Dual-fuel”, “EPA Program Officer”, and “Flexible-fuel” in alphabetical order.

■ c. Removing the definition of “Intermediate test speed”.

■ d. Adding a definition of “Intermediate speed” in alphabetical order.

■ e. Revising the definition of “NIST-traceable”.

■ f. Adding definitions of “No-load” and “Rechargeable Energy Storage System (RESS)” in alphabetical order.

■ g. Revising the definition of “Steady-state”.

The additions and revisions read as follows:

**§ 1065.1001 Definitions.**

\* \* \* \* \*

*Dual-fuel* has the meaning given in the standard-setting part.

\* \* \* \* \*

*EPA Program Officer* means the Director, Compliance Division, U.S. Environmental Protection Agency, 2000 Traverwood Dr., Ann Arbor, MI 48105.

\* \* \* \* \*

*Flexible-fuel* has the meaning given in the standard-setting part.

\* \* \* \* \*

*Intermediate speed* has the meaning given in § 1065.610.

\* \* \* \* \*

*NIST-traceable* means relating to a standard value that can be related to NIST-stated references through an unbroken chain of comparisons, all having stated uncertainties, as specified

in NIST Technical Note 1297 (incorporated by reference in § 1065.1010). Allowable uncertainty limits specified for NIST-traceability refer to the propagated uncertainty specified by NIST.

\* \* \* \* \*

*No-load* means a dynamometer setting of zero torque.

\* \* \* \* \*

*Rechargeable Energy Storage System (RESS)* means the components of a hybrid engine or vehicle that store recovered energy for later use, such as the battery system in a hybrid electric vehicle.

\* \* \* \* \*

*Steady-state* means relating to emission tests in which engine speed and load are held at a finite set of nominally constant values. Steady-state tests are generally either discrete-mode tests or ramped-modal tests.

\* \* \* \* \*

■ 263. Amend § 1065.1005 by adding an entry in Table 1 in paragraph (a) for “κ” in alphanumeric order and revising paragraphs (b) and (f)(1), (3), and (4) to read as follows:

**§ 1065.1005 Symbols, abbreviations, acronyms, and units of measure.**

\* \* \* \* \*

(a) \* \* \*

TABLE 1 OF § 1065.1005—SYMBOLS FOR QUANTITIES

Symbol	Quantity	Unit	Unit Symbol	Units in terms of SI base units
* * * * *				
κ	opacity			
* * * * *				

\* \* \* \* \* chemical species and exhaust constituents:

(b) *Symbols for chemical species.* This part uses the following symbols for

TABLE 2 OF § 1065.1005—SYMBOLS FOR CHEMICAL SPECIES AND EXHAUST CONSTITUENTS

Symbol	Species
Ar	argon.
C	carbon.
CH <sub>2</sub> O	formaldehyde.
CH <sub>2</sub> O <sub>2</sub>	formic acid.
CH <sub>3</sub> OH	methanol.
CH <sub>4</sub>	methane.
C <sub>2</sub> H <sub>4</sub> O	acetaldehyde.
C <sub>2</sub> H <sub>5</sub> OH	ethanol.
C <sub>2</sub> H <sub>6</sub>	ethane.
C <sub>3</sub> H <sub>7</sub> OH	propanol.
C <sub>3</sub> H <sub>8</sub>	propane.
C <sub>4</sub> H <sub>10</sub>	butane.
C <sub>5</sub> H <sub>12</sub>	pentane.
CO	carbon monoxide.
CO <sub>2</sub>	carbon dioxide.

TABLE 2 OF § 1065.1005—SYMBOLS FOR CHEMICAL SPECIES AND EXHAUST CONSTITUENTS—Continued

Symbol	Species
H	atomic hydrogen.
H <sub>2</sub>	molecular hydrogen.
H <sub>2</sub> O	water.
H <sub>2</sub> SO <sub>4</sub>	sulfuric acid.
HC	hydrocarbon.
He	helium.
<sup>85</sup> Kr	krypton 85.
N <sub>2</sub>	molecular nitrogen.
NH <sub>3</sub>	ammonia.
NMHC	nonmethane hydrocarbon.
NMHCE	nonmethane hydrocarbon equivalent.
NMNEHC	nonmethane-nonethane hydrocarbon.
NO	nitric oxide.
NO <sub>2</sub>	nitrogen dioxide.
NO <sub>x</sub>	oxides of nitrogen.
N <sub>2</sub> O	nitrous oxide.
NMOG	nonmethane organic gases.
NONMHC	non-oxygenated nonmethane hydrocarbon.
NOTHC	non-oxygenated total hydrocarbon.
O <sub>2</sub>	molecular oxygen.
OHC	oxygenated hydrocarbon.
<sup>210</sup> Po	polonium 210.
PM	particulate matter.
S	sulfur.
SVOC	semi-volatile organic compound.
THC	total hydrocarbon.
THCE	total hydrocarbon equivalent.
ZrO <sub>2</sub>	zirconium dioxide.

\* \* \* \* \*  
(f) \* \* \*

(1) This part uses the following constants for the composition of dry air:

TABLE 6 OF § 1065.1005—CONSTANTS

Symbol	Quantity	mol/mol
γ <sub>Ar</sub> air	amount of argon in dry air	0.00934
γ <sub>CO2</sub> air	amount of carbon dioxide in dry air	0.000375
γ <sub>N2</sub> air	amount of nitrogen in dry air	0.78084
γ <sub>O2</sub> air	amount of oxygen in dry air	0.209445

\* \* \* \* \*

(3) This part uses the following molar gas constant for ideal gases:

TABLE 8 OF § 1065.1005—MOLAR GAS CONSTANT FOR IDEAL GASES

Symbol	Quantity	J/(mol·K) (m <sup>2</sup> ·kg·s <sup>-2</sup> ·mol <sup>-1</sup> ·K <sup>-1</sup> )
R	molar gas constant	8.314472

(4) This part uses the following ratios of specific heats for dilution air and diluted exhaust:

TABLE 9 OF § 1065.1005—RATIOS OF SPECIFIC HEATS FOR DILUTION AIR AND DILUTED EXHAUST

Symbol	Quantity	[J/(kg·K)]/[J/(kg·K)]
γ <sub>air</sub>	ratio of specific heats for intake air or dilution air	1.399
γ <sub>dil</sub>	ratio of specific heats for diluted exhaust	1.399
γ <sub>exh</sub>	ratio of specific heats for raw exhaust	1.385

\* \* \* \* \*

■ 264. Amend § 1065.1010 by:

■ a. Adding introductory text;

- b. Removing paragraph (a); and
- c. Redesignating paragraphs (b) through (g) as paragraphs (a) through (f).

The addition reads as follows:

#### § 1065.1010 Incorporation by reference.

Certain material is incorporated by reference into this part with the approval of the Director of the Federal Register under 5 U.S.C. 552(a) and 1 CFR part 51. To enforce any edition other than that specified in this section, EPA must publish a document in the **Federal Register** and the material must be available to the public. All approved incorporation by reference (IBR) material is available for inspection at EPA and at the National Archives and Records Administration (NARA). Contact EPA at: U.S. EPA, Air and Radiation Docket Center, WJC West Building, Room 3334, 1301 Constitution Ave. NW, Washington, DC 20004; [www.epa.gov/dockets](http://www.epa.gov/dockets); (202) 202-1744. For information on inspecting this material at NARA, visit [www.archives.gov/federal-register/cfr/ibr-locations.html](http://www.archives.gov/federal-register/cfr/ibr-locations.html) or email [fr.inspection@nara.gov](mailto:fr.inspection@nara.gov). The material may be obtained from the following sources:

\* \* \* \* \*

- 265. Revise the heading for subpart L to read as follows:

#### Subpart L—Methods for Unregulated and Special Pollutants and Additional Procedures

- 266. Amend subpart L by adding a new center header “VANADIUM SUBLIMATION IN SCR CATALYSTS” after § 1065.1111 and adding §§ 1065.1113, 1065.1115, 1065.1117, 1065.1119, and 1065.1121 under the new center header to read as follows:

#### **Vanadium Sublimation In SCR Catalysts**

##### § 1065.1113 General provisions related to vanadium sublimation temperatures in SCR catalysts.

Sections 1065.1113 through 1065.1121 specify procedures for

determining vanadium emissions from a catalyst based on catalyst temperature. Vanadium can be emitted from the surface of SCR catalysts at temperatures above 550°C, dependent on the catalyst formulation. These procedures are appropriate for measuring the vanadium sublimation product from a reactor by sampling onto an equivalent mass of alumina and performing analysis by Inductively Coupled Plasma—Optical Emission Spectroscopy (ICP—OES). Follow standard analytic chemistry methods for any aspects of the analysis that are not specified.

(a) The procedure is adapted from “Behavior of Titania-supported Vanadia and Tungsta SCR Catalysts at High Temperatures in Reactant Streams: Tungsten and Vanadium Oxide and Hydroxide Vapor Pressure Reduction by Surficial Stabilization” (Chapman, D.M., *Applied Catalysis A: General*, 2011, 392, 143–150) with modifications to the acid digestion method from “Measuring the trace elemental composition of size-resolved airborne particles” (Herner, J.D. *et al*, *Environmental Science and Technology*, 2006, 40, 1925–1933).

(b) Laboratory cleanliness is especially important throughout vanadium testing. Thoroughly clean all sampling system components and glassware before testing to avoid sample contamination.

##### § 1065.1115 Reactor design and setup.

Vanadium measurements rely on a reactor that adsorbs sublimation vapors of vanadium onto an alumina capture bed with high surface area.

(a) Configure the reactor with the alumina capture bed downstream of the catalyst in the reactor’s hot zone to adsorb vanadium vapors at high temperature. You may use quartz beads upstream of the catalyst to help stabilize reactor gas temperatures. Select an alumina material and design the reactor to minimize sintering of the alumina. For a 1-inch diameter reactor, use 4 to 5 g of 1/8 inch extrudates or -14/+24 mesh (approximately 0.7 to 1.4 mm) gamma alumina (such as Alfa Aesar,

aluminum oxide, gamma, catalyst support, high surface area, bimodal). Position the alumina downstream from either an equivalent amount of -14/+24 mesh catalyst sample or an approximately 1-inch diameter by 1 to 3-inch long catalyst-coated monolith sample cored from the production-intent vanadium catalyst substrate. Separate the alumina from the catalyst with a 0.2 to 0.4 g plug of quartz wool. Place a short 4 g plug of quartz wool downstream of the alumina to maintain the position of that bed. Use good engineering judgment to adjust as appropriate for reactors of different sizes.

(b) Include the quartz wool with the capture bed to measure vanadium content. We recommend analyzing the downstream quartz wool separately from the alumina to see if the alumina fails to capture some residual vanadium.

(c) Configure the reactor such that both the sample and capture beds are in the reactor’s hot zone. Design the reactor to maintain similar temperatures in the capture bed and catalyst. Monitor the catalyst and alumina temperatures with Type K thermocouples inserted into a thermocouple well that is in contact with the catalyst sample bed.

(d) If there is a risk that the quartz wool and capture bed are not able to collect all the vanadium, configure the reactor with an additional capture bed and quartz wool plug just outside the hot zone and analyze the additional capture bed and quartz wool separately.

(e) An example of a catalyst-coated monolith and capture bed arrangement in the reactor tube are shown in the following figure:

#### **Figure 1 to paragraph (e) of § 1065.1115— Example of Reactor Setup**

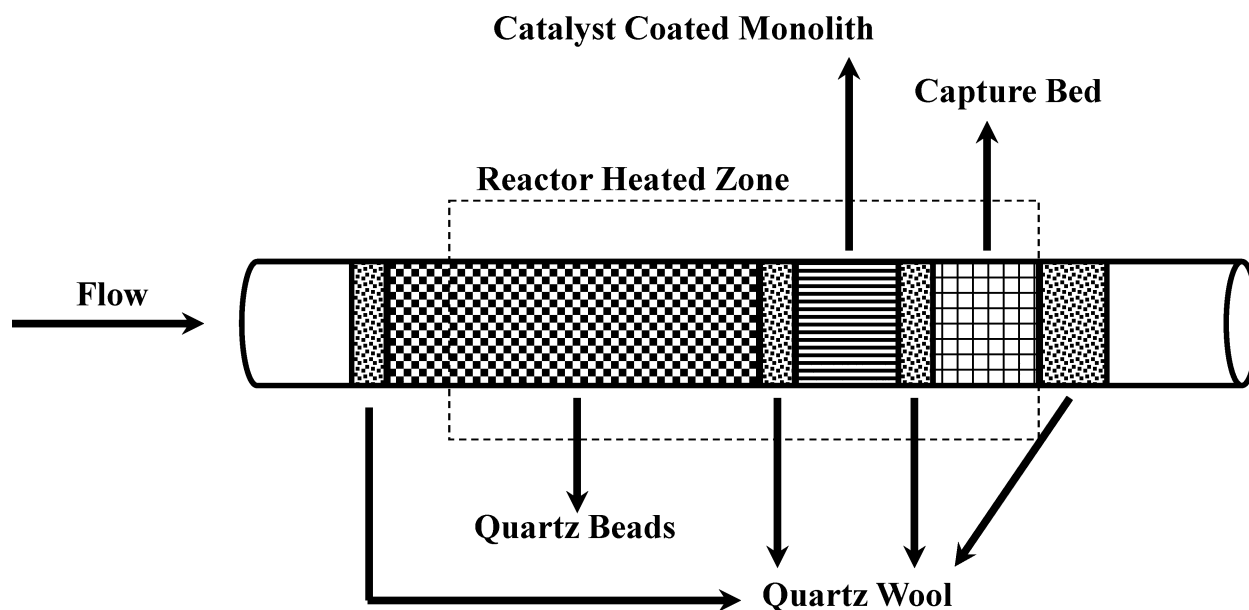

(f) You may need to account for vanadium-loaded particles contaminating catalyst-coated monoliths as a result of physical abrasion. To do this, determine how much titanium is in the capture bed and compare to an alumina blank. Using these values and available information about the ratio of vanadium to titanium in the catalyst, subtract the mass of vanadium catalyst material associated with the catalyst particles from the total measured vanadium on the capture bed to determine the vanadium recovered due to sublimation.

**§ 1065.1117 Reactor aging cycle for determination of vanadium sublimation temperature.**

This section describes the conditions and process required to operate the reactor described in § 1065.1115 for collection of the vanadium sublimation samples for determination of vanadium sublimation temperature. The reactor aging cycle constitutes the process of testing the catalyst sample over all the test conditions described in paragraph (b) of this section.

(a) Set up the reactor to flow gases with a space velocity of at least 35,000/hr with a pressure drop across the catalyst and capture beds less than 35 kPa. Use test gases meeting the following specifications, noting that not all gases will be used at the same time:

- (1) 5 vol% O<sub>2</sub>, balance N<sub>2</sub>.
- (2) NO, balance N<sub>2</sub>. Use an NO concentration of (200 to 500) ppm.
- (3) NH<sub>3</sub>, balance N<sub>2</sub>. Use an NH<sub>3</sub> concentration of (200 to 500) ppm.

(b) Perform testing as follows:

(1) Add a new catalyst sample and capture bed into the reactor as described in § 1065.1113. Heat the reactor to 550°C

while flowing the oxygen blend specified in paragraph (a)(1) of this section as a pretest gas mixture. Ensure that no H<sub>2</sub>O is added to the pretest gas mixture to reduce the risk of sintering and vanadium sublimation.

(2) Start testing at a temperature that is lower than the point at which vanadium starts to sublime. Start testing when the reactor reaches 550°C unless testing supports a lower starting temperature. Once the reactor reaches the starting temperature and the catalyst has been equilibrated to the reactor temperature, flow NO and NH<sub>3</sub> test gases for 18 hours with a nominal H<sub>2</sub>O content of 5 volume percent. If an initial starting temperature of 550°C results in vanadium sublimation, you may retest using a new catalyst sample and a lower initial starting temperature.

(3) After 18 hours of exposure, flow the pretest oxygen blend as specified in paragraph (b)(1) of this section and allow the reactor to cool down to room temperature.

(4) Analyze the sample as described in § 1065.1121.

(5) Repeat the testing in paragraphs (b)(1) through (4) of this section by raising the reactor temperature in increments of 50°C up to the temperature at which vanadium sublimation begins.

(6) Once sublimation has been detected, repeat the testing in paragraphs (b)(1) through (4) of this section by decreasing the reactor temperature in increments of 25 °C until the vanadium concentration falls below the sublimation threshold.

(7) Repeat the testing in paragraphs (b)(1) through (6) of this section with a nominal H<sub>2</sub>O concentration of 10

volume percent or the maximum water concentration expected at the standard.

(8) You may optionally test in a manner other than testing a single catalyst formulation in series across all test temperatures. For example, you may test additional samples at the same reactor temperature before moving on to the next temperature.

(c) The effective sublimation temperature for the tested catalyst is the lowest reactor temperature determined in paragraph (b) of this section below which vanadium emissions are less than the method detection limit.

**§ 1065.1119 Blank testing.**

This section describes the process for analyzing blanks. Use blanks to determine the background effects and the potential for contamination from the sampling process.

(a) Take blanks from the same batch of alumina used for the capture bed.

(b) Media blanks are used to determine if there is any contamination in the sample media. Analyze at least one media blank for each reactor aging cycle or round of testing performed under § 1065.1117. If your sample media is taken from the same lot, you may analyze media blanks less frequently consistent with good engineering judgment.

(c) Field blanks are used to determine if there is any contamination from environmental exposure of the sample media. Analyze at least one field blank for each reactor aging cycle or round of testing performed under § 1065.1117. Field blanks must be contained in a sealed environment and accompany the reactor sampling system throughout the course of a test, including reactor disassembly, sample packaging, and

storage. Use good engineering judgment to determine how frequently to generate field blanks. Keep the field blank sample close to the reactor during testing.

(d) Reactor blanks are used to determine if there is any contamination from the sampling system. Analyze at least one reactor blank for each reactor aging cycle or round of testing performed under § 1065.1117.

(1) Test reactor blanks with the reactor on and operated identically to that of a catalyst test in § 1065.1117 with the exception that when loading the reactor, only the alumina capture bed will be loaded (no catalyst sample is loaded for the reactor blank). We recommend acquiring reactor blanks with the reactor operating at average test temperature you used when acquiring your test samples under § 1065.1117.

(2) You must run at least three reactor blanks if the result from the initial blank analysis is above the detection limit of the method, with additional blank runs based on the uncertainty of the reactor blank measurements, consistent with good engineering judgment.

#### § 1065.1121 Vanadium sample dissolution and analysis in alumina capture beds.

This section describes the process for dissolution of vanadium from the vanadium sublimation samples collect in § 1065.1117 and any blanks collected in § 1065.1119 as well as the analysis of the digestates to determine the mass of vanadium emitted and the associated sublimation temperature threshold based on the results of all the samples taken during the reactor aging cycle.

(a) Digest the samples using the following procedure, or an equivalent procedure:

(1) Place the recovered alumina, a portion of the ground quartz tube from the reactor, and the quartz wool in a Teflon pressure vessel with a mixture made from 1.5 mL of 16 N HNO<sub>3</sub>, 0.5 mL of 28 N HF, and 0.2 mL of 12 N HCl. Note that the amount of ground quartz tube from the reactor included in the digestion can influence the vanadium concentration of both the volatilized vanadium from the sample and the method detection limit. You must be consistent with the amount ground quartz tube included in the sample analysis for your testing. You must limit the amount of quartz tube to include only portions of the tube that would be likely to encounter volatilized vanadium.

(2) Program a microwave oven to heat the sample to 180 °C over 9 minutes, followed by a 10-minute hold at that temperature, and 1 hour of ventilation/cooling.

(3) After cooling, dilute the digests to 30 mL with high purity 18MΩ water prior to ICP-MS (or ICP-OES) analysis. Note that this digestion technique requires adequate safety measures when working with HF at high temperature and pressure. To avoid “carry-over” contamination, rigorously clean the vessels between samples as described in “Microwave digestion procedures for environmental matrixes” (Lough, G.C. *et al*, *Analyst*. 1998, 123 (7), 103R–133R).

(b) Analyze the digestates for vanadium as follows:

(1) Perform the analysis using ICP-OES (or ICP-MS) using standard plasma conditions (1350 W forward power) and a desolvating microconcentric nebulizer, which will significantly reduce oxide- and chloride-based interferences.

(2) We recommend that you digest and analyze a minimum of three solid vanadium NIST Standard Reference Materials in duplicate with every batch of 25 vanadium alumina capture bed samples that you analyze in this section, as described in “Emissions of metals associated with motor vehicle roadways” (Herner, J.D. *et al*, *Environmental Science and Technology*. 2005, 39, 826–836). This will serve as a quality assurance check to help gauge the relative uncertainties in each measurement, specifically if the measurement errors are normally distributed and independent.

(3) Use the 3-sigma approach to determine the analytical method detection limits for vanadium and the 10-sigma approach if you determine the reporting limit. This process involves analyzing at least seven replicates of a reactor blank using the analytical method described in paragraphs (a) and (b)(1) of this section, converting the responses into concentration units, and calculating the standard deviation. Determine the detection limit by multiplying the standard deviation by 3 and adding it to the average. Determine the reporting limit by multiplying the standard deviation by 10 and adding it to the average. Determine the following analytical method detection limits:

(i) Determine the ICP-MS (or ICP-OES) instrumental detection limit (ng/L) by measuring at least seven blank samples made up of the reagents from paragraph (a) of this section.

(ii) Determine the method detection limit (µg/m<sup>3</sup> of flow) by measuring at least seven reactor blank samples taken as described in § 1065.1119(d).

(iii) We recommend that your method detection limit determined under paragraph (b)(3)(ii) of this section is at or below 15 µg/m<sup>3</sup>. You must report your detection limits determined in this

paragraph (b)(3) and reporting limits (if determined) with your test results.

(4) If you account for vanadium-loaded particles contaminating catalyst-coated monoliths as a result of physical abrasion as allowed in § 1065.1115(f), use the 3-sigma approach to determine the analytical method detection limits for titanium and the 10-sigma approach if you determine the reporting limit. This process involves analyzing at least seven replicates of a blank using the analytical method described in paragraphs (a) and (b)(1) of this section, converting the responses into concentration units, and calculating the standard deviation. Determine the detection limit by multiplying the standard deviation by 3 and subtracting it from the average. Determine the reporting limit by multiplying the standard deviation by 10 and subtracting it from the average.

(i) Determine the ICP-MS (or ICP-OES) instrumental detection limit (ng/L) by measuring at least seven blank samples made up of the reagents from paragraph (a) of this section.

(ii) Determine the method detection limit (µg/m<sup>3</sup> of flow) by measuring at least seven reactor blank samples taken as described in § 1065.1119(d).

■ 267. Amend subpart L by adding a new center header “SMOKE OPACITY” after the newly added § 1065.1121 and adding §§ 1065.1123, 1065.1125, and 1065.1127 under the new center header to read as follows:

#### Smoke Opacity

##### § 1065.1123 General provisions for determining exhaust opacity.

The provisions of § 1065.1125 describe system specifications for measuring percent opacity of exhaust for all types of engines. The provisions of § 1065.1127 describe how to use such a system to determine percent opacity of engine exhaust for applications other than locomotives. See 40 CFR 1033.525 for measurement procedures for locomotives.

##### § 1065.1125 Exhaust opacity measurement system.

Smokemeters measure exhaust opacity using full-flow open-path light extinction with a built-in light beam across the exhaust stack or plume. Prepare and install a smokemeter system as follows:

(a) Except as specified in paragraph (d) of this section, use a smokemeter capable of providing continuous measurement that meets the following specifications:

(1) Use an incandescent lamp with a color temperature between (2800 and 3250) K or a different light source with

a spectral peak between (550 and 570) nm.

(2) Collimate the light beam to a nominal diameter of 3 centimeters and maximum divergence angle of 6 degrees.

(3) Include a photocell or photodiode as a detector. The detector must have a maximum spectral response between (550 and 570) nm, with less than 4 percent of that maximum response

below 430 nm and above 680 nm. These specifications correspond to visual perception with the human eye.

(4) Use a collimating tube with an aperture that matches the diameter of the light beam. Restrict the detector to viewing within a 16 degree included angle.

(5) Optionally use an air curtain across the light source and detector

window to minimize deposition of smoke particles, as long as it does not measurably affect the opacity of the sample.

(6) The diagram in the following figure illustrates the smokemeter configuration:

Figure 1 to paragraph (a)(6) of § 1065.1125—Smokemeter Diagram

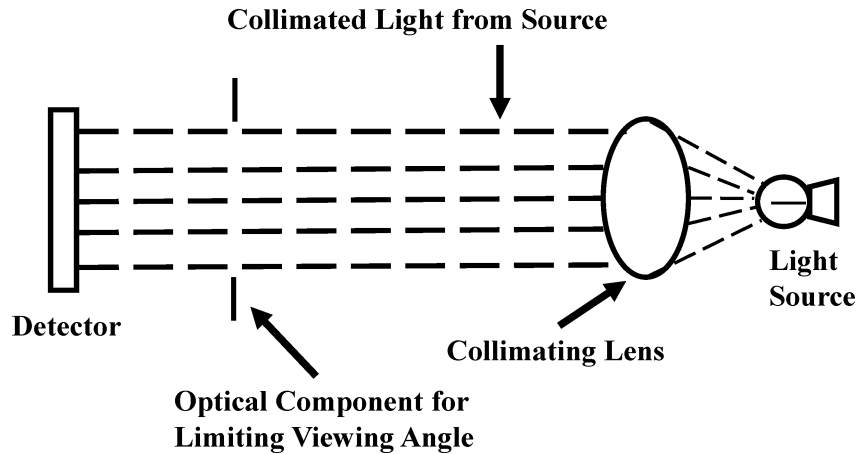

(b) Smokemeters for locomotive applications must have a full-scale response time of 0.5 seconds or less. Smokemeters for locomotive applications may attenuate signal responses with frequencies higher than 10 Hz with a separate low-pass electronic filter that has the following performance characteristics:

- (1) Three decibel point: 10 Hz.
- (2) Insertion loss: (0.0 ±0.5) dB.
- (3) Selectivity: 12 dB down at 40 Hz minimum.
- (4) Attenuation: 27 dB down at 40 Hz minimum.

(c) Configure exhaust systems as follows for measuring exhaust opacity:

- (1) For locomotive applications:
  - (i) Optionally add a stack extension to the locomotive muffler.
  - (ii) For in-line measurements, the smokemeter is integral to the stack extension.
  - (iii) For end-of-line measurements, mount the smokemeter directly at the end of the stack extension or muffler.
  - (iv) For all testing, minimize distance from the optical centerline to the muffler outlet; in no case may it be more than 300 cm. The maximum allowable distance of unducted space upstream of the optical centerline is 50 cm, whether the unducted portion is upstream or downstream of the stack extensions.

(2) Meet the following specifications for all other applications:

- (i) For in-line measurements, install the smokemeter in an exhaust pipe segment downstream of all engine

components. This will typically be part of a laboratory configuration to route the exhaust to an analyzer. The exhaust pipe diameter must be constant within 3 exhaust pipe diameters before and after the smokemeter's optical centerline. The exhaust pipe diameter may not change by more than a 12-degree half-angle within 6 exhaust pipe diameters upstream of the smokemeter's optical centerline.

(ii) For end-of-line measurements with systems that vent exhaust to the ambient, add a stack extension and position the smokemeter such that its optical centerline is (2.5 ±0.625) cm upstream of the stack extension's exit. Configure the exhaust stack and extension such that at least the last 60 cm is a straight pipe with a circular cross section with an approximate inside diameter as specified in the following table:

TABLE 1 TO PARAGRAPH (c)(2)(ii) OF § 1065.1125—APPROXIMATE EXHAUST PIPE DIAMETER BASED ON ENGINE POWER

Maximum rated power	Approximate exhaust pipe diameter (mm)
kW<40 .....	38
40≤kW<75 .....	50
75≤kW<150 .....	76
150≤kW<225 .....	102
225≤kW<375 .....	127

TABLE 1 TO PARAGRAPH (c)(2)(ii) OF § 1065.1125—APPROXIMATE EXHAUST PIPE DIAMETER BASED ON ENGINE POWER—Continued

Maximum rated power	Approximate exhaust pipe diameter (mm)
kW≥ 375 .....	152

(iii) For both in-line and end-of-line measurements, install the smokemeter so its optical centerline is (3 to 10) meters further downstream than the point in the exhaust stream that is farthest downstream considering all the following components: exhaust manifolds, turbocharger outlets, exhaust aftertreatment devices, and junction points for combining exhaust flow from multiple exhaust manifolds.

(3) Orient the light beam perpendicular to the direction of exhaust flow. Install the smokemeter so it does not influence exhaust flow distribution or the shape of the exhaust plume. Set up the smokemeter's optical path length as follows:

- (i) For locomotive applications, the optical path length must be at least as wide as the exhaust plume.
- (ii) For all other applications, the optical path length must be the same as the diameter of the exhaust flow. For noncircular exhaust configurations, set up the smokemeter such that the light beam's path length is across the longest

axis with an optical path length equal to the hydraulic diameter of the exhaust flow.

(4) The smokemeter must not interfere with the engine's ability to meet the exhaust backpressure requirements in § 1065.130(h).

(5) For engines with multiple exhaust outlets, measure opacity using one of the following methods:

(i) Join the exhaust outlets together to form a single flow path and install the smokemeter (3 to 10) m downstream of the point where the exhaust streams converge or the last exhaust aftertreatment device, whichever is farthest downstream.

(ii) Install a smokemeter in each of the exhaust flow paths. Report all measured values. All measured values must comply with standards.

(6) The smokemeter may use purge air or a different method to prevent carbon or other exhaust deposits on the light source and detector. Such a method used with end-of-line measurements may not cause the smoke plume to change by more than 0.5 cm at the smokemeter. If such a method affects the smokemeter's optical path length, follow the smokemeter manufacturer's instructions to properly account for that effect.

(d) You may use smokemeters meeting alternative specifications as follows:

(1) You may use smokemeters that use other electronic or optical techniques if they employ substantially identical measurement principles and produce substantially equivalent results.

(2) You may ask us to approve the use of a smokemeter that relies on partial flow sampling. Follow the instrument manufacturer's installation, calibration, operation, and maintenance procedures if we approve your request. These procedures must include correcting for any change in the path length of the exhaust plume relative to the diameter of the engine's exhaust outlet.

#### § 1065.1127 Test procedure for determining percent opacity.

The test procedure described in this section applies for everything other than locomotives. The test consists of a sequence of engine operating points on an engine dynamometer to measure exhaust opacity during specific engine operating modes to represent in-use operation. Measure opacity using the following procedure:

(a) Use the equipment and procedures specified in this part 1065.

(b) Calibrate the smokemeter as follows:

(1) Calibrate using neutral density filters with approximately 10, 20, and

40 percent opacity. Confirm that the opacity values for each of these reference filters are NIST-traceable within 185 days of testing, or within 370 days of testing if you consistently protect the reference filters from light exposure between tests.

(2) Before each test and optionally during engine idle modes, remove the smokemeter from the exhaust stream, if applicable, and calibrate as follows:

(i) *Zero*. Adjust the smokemeter to give a zero response when there is no detectable smoke.

(ii) *Linearity*. Insert each of the qualified reference filters in the light path perpendicular to the axis of the light beam and adjust the smokemeter to give a result within 1 percentage point of the named value for each reference filter.

(c) Prepare the engine, dynamometer, and smokemeter for testing as follows:

(1) Set up the engine to run in a configuration that represents in-use operation.

(2) Determine the smokemeter's optical path length to the nearest mm.

(3) If the smokemeter uses purge air or another method to prevent deposits on the light source and detector, adjust the system according to the system manufacturer's instructions and activate the system before starting the engine.

(4) Program the dynamometer to operate in torque-control mode throughout testing. Determine the dynamometer load needed to meet the cycle requirements in paragraphs (d)(4)(ii) and (iv) of this section.

(5) You may program the dynamometer to apply motoring assist with negative flywheel torque, but only during the first 0.5 seconds of the acceleration events in paragraphs (d)(4)(i) and (ii) of this section. Negative flywheel torque may not exceed 13.6 N·m.

(d) Operate the engine and dynamometer over repeated test runs of the duty cycle illustrated in Figure 1 of this appendix. As noted in the figure, the test run includes an acceleration mode from points A through F in the figure, followed by a lugging mode from points I to J. Detailed specifications for testing apply as follows:

(1) Continuously record opacity, engine speed, engine torque, and operator demand over the course of the entire test at 10 Hz; however, you may interrupt measurements to recalibrate during each idle mode.

(2) Precondition the engine by operating it for 10 minutes at maximum mapped power.

(3) Operate the engine for (5.0 to 5.5) minutes at warm idle speed,  $f_{\text{idle}}$ , with

load set to Curb Idle Transmission Torque.

(4) Operate the engine and dynamometer as follows during the acceleration mode:

(i) *First acceleration event—AB*. Partially increase and hold operator demand to stabilize engine speed briefly at  $(200 \pm 50)$  r/min above  $f_{\text{idle}}$ . The start of this acceleration is the start of the test ( $t = 0$  s).

(ii) *Second acceleration event—CD*. As soon as measured engine speed is within the range specified in paragraph (d)(4)(i) of this section, but not more than 3 seconds after the start of the test, rapidly set and hold operator demand at maximum. Operate the dynamometer using a preselected load to accelerate engine speed to 85 percent of maximum test speed,  $f_{\text{ntest}}$ , in  $(5 \pm 1.5)$  seconds. The engine speed throughout the acceleration must be within  $\pm 100$  r/min of a target represented by a linear transition between the low and high engine speed targets.

(iii) *Transition—DEF*. As soon as measured engine speed reaches 85 percent of  $f_{\text{ntest}}$ , rapidly set and hold operator demand at minimum and simultaneously apply a load to decelerate to intermediate speed in (0.5 to 3.5) seconds. Use the same load identified for the acceleration event in paragraph (d)(4)(iv) of this section.

(iv) *Third acceleration event—FGH*. Rapidly set and hold operator demand at maximum when the engine is within  $\pm 50$  r/min of intermediate speed. Operate the dynamometer using a preselected load to accelerate engine speed to at least 95 percent of  $f_{\text{ntest}}$  in  $(10 \pm 2)$  seconds.

(5) Operate the engine and dynamometer as follows during the lugging mode:

(i) *Transition—HI*. When the engine reaches 95 percent of  $f_{\text{ntest}}$ , keep operator demand at maximum and immediately set dynamometer load to control the engine at maximum mapped power. Continue the transition segment for (50 to 60) seconds. For at least the last 10 seconds of the transition segment, hold engine speed within  $\pm 50$  r/min of  $f_{\text{ntest}}$  and power at or above 95 percent of maximum mapped power. Conclude the transition by increasing dynamometer load to reduce engine speed as specified in paragraph (d)(4)(iii) of this section, keeping operator demand at maximum.

(ii) *Lugging—IJ*. Apply dynamometer loading as needed to decrease engine speed from 50 r/min below  $f_{\text{ntest}}$  to intermediate speed in  $(35 \pm 5)$  seconds. The engine speed must remain within  $\pm 100$  r/min of a target represented by a



linear transition between the low and high engine speed targets.

(6) Return the dynamometer and engine controls to the idle position described in paragraph (d)(3) of this section within 60 seconds of completing the lugging mode.

(7) Repeat the procedures in paragraphs (d)(3) through (6) of this section as needed to complete three valid test runs. If you fail to meet the specifications during a test run, continue to follow the specified duty cycle before starting the next test run.

(8) Shut down the engine or remove the smokemeter from the exhaust stream to verify zero and linearity. Void the test if the smokemeter reports more than 2 percent opacity for the zero verification, or if the smokemeter's error for any of the linearity checks specified in paragraph (b)(2) of this section is more than 2 percent.

(e) Analyze and validate the test data as follows:

(1) Divide each test run into test segments. Each successive test segment starts when the preceding segment ends. Identify the test segments based on the following criteria:

(i) The idle mode specified in paragraph (d)(3) of this section for the first test run starts immediately after engine preconditioning is complete. The idle mode for later test runs must start within 60 seconds after the end of the previous test run as specified in paragraph (d)(6) of this section. The idle mode ends when operator demand increases for the first acceleration event (Points A and B).

(ii) The first acceleration event in paragraph (d)(4)(i) of this section ends when operator demand is set to maximum for the second acceleration event (Point C).

(iii) The second acceleration event in paragraph (d)(4)(ii) of this section ends when the engine reaches 85 percent of maximum test speed,  $f_{ntest}$ . (Point D) and

operator demand is set to minimum (Point E).

(iv) The transition period in paragraph (d)(4)(iii) of this section ends when operator demand is set to maximum (Point F).

(v) The third acceleration event in paragraph (d)(4)(iv) of this section ends when engine speed reaches 95 percent of  $f_{ntest}$  (Point H).

(vi) The transition period in paragraph (d)(5)(i) of this section ends when engine speed first decreases to a point more than 50 r/min below  $f_{ntest}$  (Point I).

(vii) The lugging mode in paragraph (d)(5)(ii) of this section ends when the engine reaches intermediate speed (Point J).

(2) Convert measured instantaneous values to standard opacity values,  $\kappa_{std}$ , based on the appropriate optical path length specified in Table 1 of § 1065.1125 using the following equation:

$$\kappa_{std} = 100 \cdot \left( 1 - \left( 1 - \frac{\kappa_{meas}}{100} \right)^{\frac{l_{std}}{l_{meas}}} \right)$$

Eq. 1065.1127-1

Where:

$\kappa_{std}$  = standard instantaneous percent opacity.

$\kappa_{meas}$  = measured instantaneous percent opacity.

$l_{std}$  = standard optical path length corresponding with engine power, in millimeters.

$l_{meas}$  = the smokemeter's optical path length, in millimeters.

Example for an engine < 40 kW:

$\kappa_{meas} = 14.1\%$

$l_{std} = 38\text{ mm}$

$l_{meas} = 41\text{ mm}$

$$\kappa_{std} = 100 \cdot \left( 1 - \left( 1 - \frac{14.1}{100} \right)^{\frac{38}{41}} \right) = 13.1\%$$

(3) Select opacity results from corrected measurements collected across test segments as follows:

(i) Divide measurements from acceleration and lugging modes into half-second intervals. Determine average opacity values during each half-second interval.

(ii) Identify the 15 highest half-second values during the acceleration mode of each test run.

(iii) Identify the five highest half-second values during the lugging mode of each test run.

(iv) Identify the three overall highest values from paragraphs (e)(3)(ii) and (iii) of this section for each test run.

(f) Determine percent opacity as follows:

(1) *Acceleration.* Determine the percent opacity for the acceleration mode by calculating the average of the 45 readings from paragraph (e)(3)(ii) of this section.

(2) *Lugging.* Determine the percent opacity for the lugging mode by calculating the average of the 15 readings from paragraph (e)(3)(iii) of this section.

(3) *Peak.* Determine the percent opacity for the peaks in either acceleration or lugging mode by calculating the average of the 9 readings from paragraph (e)(3)(iv) of this section.

(g) Submit the following information in addition to what is required by § 1065.695:

(1) Exhaust pipe diameter(s).

(2) Measured maximum exhaust system backpressure over the entire test.

(3) Most recent date for establishing that each of the reference filters from paragraph (b) of this section are NIST-traceable.

(4) Measured smokemeter zero and linearity values after testing.

(5) 10 Hz data from all valid test runs.

(h) The following figure illustrates the dynamometer controls and engine speeds for exhaust opacity testing:

**Figure 1 to paragraph (h) of § 1065.1127—Schemati of Smoke Opacity Duty Cycle**

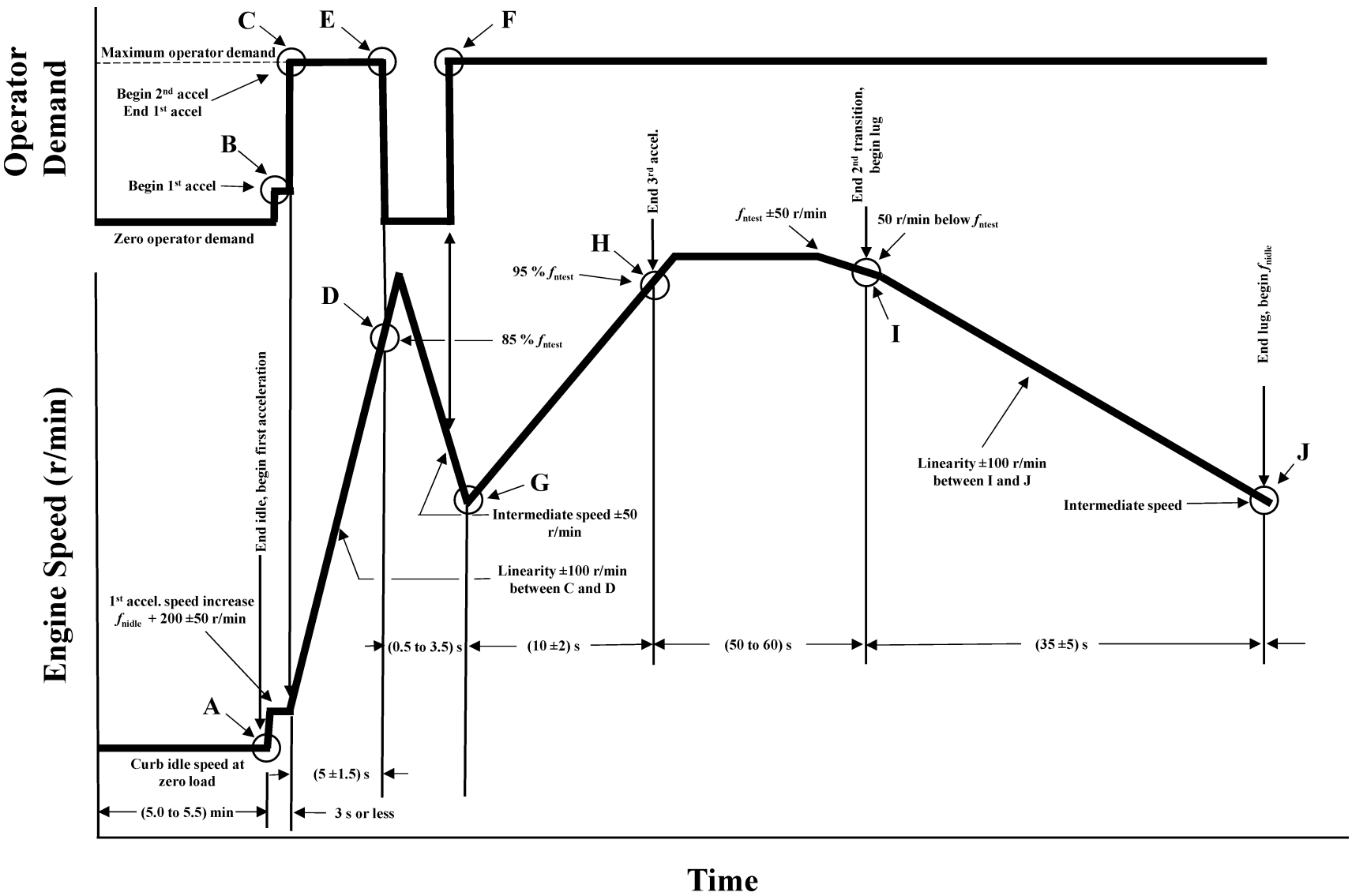

■ 268. Amend subpart L by adding a new center header "ACCELERATED

AFTERTREATMENT AGING" after the newly added § 1065.1127 and adding

§§ 1065.1131 through 1065.1145 under

the new center header to read as follows:

### Accelerated Aftertreatment Aging

#### § 1065.1131 General provisions related to accelerated aging of compression-ignition aftertreatment for deterioration factor determination.

Sections 1065.1131 through 1065.1145 specify procedures for aging compression-ignition engine aftertreatment systems in an accelerated fashion to produce an aged aftertreatment system for durability demonstration. Determine the target number of hours that represents useful life for an engine family as described in the standard setting part. The method described is a procedure for translating field data that represents a given application into an accelerated aging cycle for that specific application, as well as methods for carrying out aging using that cycle. The procedure is intended to be representative of field aging, includes exposure to elements of both thermal and chemical aging, and is designed to achieve an acceleration of aging that is ten times a dynamometer or field test (1,000 hours of accelerated aging is equivalent to 10,000 hours of standard aging).

(a) Development of an application-specific accelerated aging cycle generally consists of the following steps:

- (1) Gathering and analysis of input field data.
- (2) Determination of key components for aging.
- (3) Determination of a thermal deactivation coefficient for each key component.
- (4) Determination of potential aging modes using clustering analysis.
- (5) Down-selection of final aging modes.
- (6) Incorporation of regeneration modes (if necessary).
- (7) Cycle generation.
- (8) Calculation of thermal deactivation.
- (9) Cycle scaling to reach thermal deactivation.
- (10) Determination of oil exposure rates.
- (11) Determination of sulfur exposure rates.

(b) There are two methods for using field data to develop aging cycles, as described in § 1065.1139(b)(1) and (2). Method selection depends on the type of field data available. Method 1 directly uses field data to generate aging modes, while Method 2 uses field data to weight appropriate regulatory duty cycles that are used for emissions certification.

(c) Carry out accelerated aging on either a modified engine platform or a

reactor-based burner platform. The requirements for these platforms are described in § 1065.1141 for engine bench aging and § 1065.1143 for burner-based bench aging.

#### § 1065.1133 Application selection, data gathering, and analysis.

This section describes the gathering and analysis of the field generated data that is required for generation of the data cycle. Gather data for the determination of aftertreatment exposure to thermal, lubricating oil, and sulfur related aging factors. You are not required to submit this data as part of your application, but you must make this data available if we request it.

(a) *Field data target selection.* Use good engineering judgment to select one or more target applications for gathering of input field data for the accelerated aging cycle generation that represent a greater than average exposure to potential field aging factors. It should be noted that the same application may not necessarily represent the worst case for all aging factors. If sufficient data is not available to make this determination with multiple applications, you may select the application that is expected to have the highest sales volume for a given engine family.

(1) *Thermal exposure.* We recommend that you select applications for a given engine family that represent the 90th percentile of exposure to thermal aging. For example, if a given engine family incorporates a periodic infrequent regeneration event that involves exposure to higher temperatures than are observed during normal (non-regeneration) operation, we recommend that you select an application wherein the total duration of the cumulative regeneration events is at the 90th percentile of expected applications for that family. For an engine that does not incorporate a distinct regeneration event, we recommend selecting an application that represents the 90th percentile in terms of the overall average temperature.

(2) *Oil exposure.* Use a combination of field and laboratory measurements to determine an average rate of oil consumption in grams per hour that reaches the exhaust. You may use the average total oil consumption rate of the engine if you are unable to determine what portion of the oil consumed reaches the exhaust aftertreatment.

(3) *Sulfur exposure.* The total sulfur exposure is the sum of fuel- and oil-related sulfur. Oil-related sulfur will be accounted for in the acceleration of oil exposure directly. We recommend that you determine fuel-related sulfur exposure by selecting an application

that represents the 90th percentile of fuel consumption. Use good engineering judgment to determine that average rate of fuel consumption for the target application. You may use a combination of field and laboratory measurements to make this determination. Calculate the average rate of fuel-related sulfur exposure in grams per hour from the average rate of fuel consumption assuming a fuel sulfur level of 10 ppm by weight.

(b) *Application data gathering.* Use good engineering judgment to gather data from one or more field vehicles to support the accelerated aging cycle generation. We recommend that you gather data at a recording frequency of 1 Hz. The type of data that you gather will depend on the method you plan to use for cycle generation. Record both the data and the number of engine operating hours which that data represents regardless of method, as this information will be used to scale the cycle calculations. Use good engineering judgment to ensure that the amount of data recorded provides an accurate representation of field operation for the target application. If your application includes a periodic regeneration event, you must record multiple events to ensure that you have accurately captured the variation of those events. We recommend that you record at least 300 hours of field operation, and at least 3 different regeneration events if applicable.

(1) When using Method 1, direct field data use, as described in § 1065.1139(b)(1), record data for exhaust flow rate and at least one representative inlet temperature for each major aftertreatment system catalyst component, such as a diesel oxidation catalyst (DOC), diesel particulate filter (DPF), or selective catalytic reduction (SCR) catalyst. If a given catalyst component has multiple substrates installed directly in sequence, it is sufficient to record only the inlet temperature for the first catalyst substrate in the sequence. It is not necessary to record separate temperatures for substrates that are "zone-coated" with multiple catalyst functions. Record a representative outlet temperature for any major catalyst component that is used to elevate the temperature of downstream components. This could be the inlet of the next major component if that would be representative. We recommend that you record engine fuel rate to assist in the determination of sulfur exposure rates, but you may use other data for this purpose.

(2) When using Method 2, weighting of certification cycles, as described

§ 1065.1139(b)(2), record data for engine speed and engine load. Record sufficient ECM load parameters to determine a torque value that can be compared directly to engine torque as measured in the laboratory. You may optionally use ECM fuel rate measurements to determine load, but only if the same measurements can also be performed during laboratory testing on certification test cycles using sensors with comparable response characteristics. For example, you could use ECM fuel consumption rates for both field data and during laboratory tests.

(i) Optionally, as an alternative to the parameters required in this paragraph (b)(2), you may use a system exhaust temperature measurement to represent load. This requires one recorded temperature that represents the aftertreatment system. We recommend that you use a temperature recorded at the outlet of the first major catalyst component. If you choose to use this option, you must use the same temperature sensor for both field and laboratory measurements. Do not compare measurements between on-engine production temperature sensors with laboratory temperature sensors.

(ii) Optionally, as an alternative to the parameters required in this paragraph (b)(2), you may use exhaust flow and temperature measurements recorded in the field to support Method 2 calculations. Only one recorded temperature that represents the aftertreatment system is needed in this case. We recommend that you use a temperature recorded at the outlet of the first major catalyst component. Do not compare measurements between on-engine production temperature sensors with laboratory temperature sensors.

(3) If you have an aftertreatment system which involves periodic regeneration events where the temperature is raised above levels observed during normal operation, you must record data to characterize each such event. Data must be recorded at a frequency of at least 1 Hz, and you must record the exhaust flow rate and inlet temperature of each key catalyst component that will experience elevated temperatures during the regeneration. In addition, record a flag or variable that can be used to determine the beginning and end of a regeneration event. You must record at least three such events to allow determination of the average regeneration profile. If you have multiple types of regeneration events which influence different catalyst components in the system, you must record this data for each type of event separately. Use good engineering

judgment to determine the average duration of each type of regeneration event, and the average interval of time between successive regeneration events of that type. You may use the data recorded for this cycle determination, or any other representative data to determine average regeneration duration or regeneration interval. These values may be determined from the analysis used to determine emission adjustments to account for infrequent regeneration of aftertreatment devices in § 1065.680.

**§ 1065.1135 Determination of key aftertreatment system components.**

Most compression-ignition engine aftertreatment systems contain multiple catalysts, each with their own aging characteristics. However, in the accelerated aging protocol the system will be aged as a whole. Therefore, it is necessary to determine which catalyst components are the key components that will be used for deriving and scaling the aging cycle.

(a) The primary aging catalyst in an aftertreatment system is the catalyst that is directly responsible for the majority of NO<sub>x</sub> reduction, such as a urea SCR catalyst in a compression ignition aftertreatment system. This catalyst will be used as the basis for cycle generation. If a system contains multiple SCR catalysts that are separated by other heat generating components that would result in a different rate of heat exposure, then each SCR catalyst must be tracked separately. Use good engineering judgment to determine when there are multiple primary catalyst components. An example of this would be a light-off SCR catalyst placed upstream of a DOC which is used to generate heat for regeneration and is followed by a DPF and a second downstream SCR catalyst. In this case, both the light-off SCR and the downstream SCR would have very different thermal history, and therefore must be tracked separately. In applications where there is no SCR catalyst in the aftertreatment system, the primary catalyst is the first oxidizing catalyst component in the system which is typically a DOC or catalyzed DPF.

(b) The secondary aging catalyst in an aftertreatment system is the catalyst that is intended to either alter exhaust characteristics or generate elevated temperature upstream of the primary catalyst. An example of a secondary component catalyst would be a DOC placed upstream of an SCR catalyst, with or without a DPF in between.

**§ 1065.1137 Determination of thermal reactivity coefficient.**

This section describes the method for determining the thermal reactivity coefficient(s) used for thermal heat load calculation in the accelerated aging protocol.

(a) The calculations for thermal degradation are based on the use of an Arrhenius rate law function to model cumulative thermal degradation due to heat exposure. Under this model, the thermal aging rate constant,  $k$ , is an exponential function of temperature which takes the form shown in the following equation:

$$k = A \cdot e^{-\frac{E_a}{R \cdot T}}$$

Eq. 1065.1137-1

Where:

$A$  = frequency factor or pre-exponential factor.

$E_a$  = thermal reactivity coefficient in kJ/mol.

$R$  = molar gas constant.

$T$  = catalyst temperature in K.

(b) The process of determining  $E_a$  begins with determining what catalyst characteristic will be tracked as the basis for measuring thermal deactivation. This metric varies for each type of catalyst and may be determined from the experimental data using good engineering judgment. We recommend the following metrics; however, you may also use a different metric based on good engineering judgment:

(1) *Copper-based zeolite SCR.* Total ammonia storage capacity is a key aging metric for copper-zeolite SCR catalysts, and they typically contain multiple types of storage sites. It is typical to model these catalysts using two different storage sites, one of which is more active for NO<sub>x</sub> reduction, as this has been shown to be an effective metric for tracking thermal aging. In this case, the recommended aging metric is the ratio between the storage capacity of the two sites, with more active site being in the denominator.

(2) *Iron-based zeolite SCR.* Total ammonia storage capacity is a key aging metric for iron-zeolite SCR catalysts using a single storage site at 250 °C for tracking thermal aging.

(3) *Vanadium SCR.* Vanadium-based SCR catalysts do not feature a high level of ammonia storage like zeolites, therefore NO<sub>x</sub> reduction efficiency at lower temperatures in the range of 250 °C is the recommended metric for tracking thermal aging.

(4) *Diesel oxidation catalysts.* Conversion rate of NO to NO<sub>2</sub> at 200 °C is the key aging metric for tracking thermal aging for DOCs which are used to optimize exhaust characteristics for a

downstream SCR system. HC reduction efficiency (as measured using ethylene) at 200 °C is the key aging metric for DOCs which are part of a system that does not contain an SCR catalyst for NO<sub>x</sub> reduction. This same guidance applies to an oxidation catalyst coated onto the surface of a DPF, if there is no other DOC in the system.

(c)(1) Use good engineering judgment to select at least three different temperatures to run the degradation experiments at. We recommend selecting these temperatures to accelerated thermal deactivation such that measurable changes in the aging metric can be observed at multiple time points over the course of no more than 50 hours. Avoid temperatures that are too high to prevent rapid catalyst failure by a mechanism that does not represent normal aging. An example of temperatures to run the degradation experiment at for a small-pore copper zeolite SCR catalyst is 600 °C, 650 °C, and 725 °C.

(2) For each temperature selected, perform testing to assess the aging metric at different times. These time intervals do not need to be evenly spaced and it is typical to run these experiments using increasing time intervals (e.g., after 2, 4, 8, 16, and 32 hours). Use good engineering judgment to stop each temperature experiment after sufficient data has been generated to characterize the shape of the deactivation behavior at a given temperature.

(d) Generate a fit of the deactivation data generated in paragraph (b) of this section at each temperature using the generalized deactivation equation:

$$-\frac{d\Omega}{dt} = k \cdot (\Omega - \Omega_{EQ})^m$$

Eq. 1065.1137-2

Where:

$\Omega$  = aging metric.

$k$  = thermal aging rate constant for a given temperature.

$\Omega_{EQ}$  = aging metric at equilibrium (set to 0 unless there is a known activity minimum).

$m$  = model order (the model order should be set at the lowest value that best fits the data at all temperatures, minimum = 1).

(e) Using the data pairs of temperature and thermal aging rate constant,  $k$ , from paragraph (c)(2) of this section, determine the thermal reactivity coefficient,  $E_a$ , by performing a regression analysis of the natural log of  $k$  versus the inverse of temperature,  $T$ , in Kelvin. Determine  $E_a$  from the slope of the resulting line using the following equation:

$$E_a = -\frac{m}{R}$$

Eq. 1065.1137-3

Where:

$m$  = the slope of the regression line of  $\ln(k)$  versus  $1/T$ .

$R$  = molar gas constant.

#### § 1065.1139 Aging cycle generation.

Generation of the accelerated aging cycle for a given application involves analysis of the field data to determine a set of aging modes that will represent that field operation. There are two methods of cycle generation, each of which is described separately below. Method 1 involves the direct application of field data and is used when the recorded data includes sufficient exhaust flow and temperature data to allow for determination of aging conditions directly from the field data set and must be available for all of the key components. Method 2 is meant to be used when insufficient flow and temperature data is available from the field data. In Method 2, the field data is used to weight a set of modes derived from the laboratory certification cycles for a given application. These weighted modes are then combined with laboratory recorded flow and temperatures on the certification cycles to derive aging modes. There are two different cases to consider for aging cycle generation, depending on whether or not a given aftertreatment system incorporates the use of a periodic regeneration event. For the purposes of this section, a “regeneration” is any event where the operating temperature of some part of the aftertreatment system is raised beyond levels that are observed during normal (non-regeneration) operation. The analysis of regeneration data is considered separately from normal operating data.

(a) *Cycle generation process overview.* The process of cycle generation begins with the determination of the number of bench aging hours. The input into this calculation is the number of real or field hours that represent the useful life for the target application. This could be given as a number of hours or miles, and for miles, the manufacturer must use field data and good engineering judgment to translate this to an equivalent number of operating hours for the target application. The target for the accelerated aging protocol is a 10-time acceleration of the aging process, therefore the total number of aging hours is always set at useful life hours divided by 10. For example, if an on-highway heavy duty engine has a full useful life of 750,000 miles and this is determined to be represented by 24,150

field hours, the target duration for the DAAAC protocol for this application would be 2,415 bench-aging hours. The 2,415 hours will then be divided among different operating modes that will be arranged to result in repetitive temperature cycling over that period. For systems that incorporate periodic regeneration, the total duration will be split between regeneration and normal (non-regeneration) operation. The analysis of normal operation data is given in paragraph (b) of this section. The analysis of regeneration data is given in paragraph (c) of this section.

(b) *Analysis of normal (non-regeneration) operating data.* This analysis develops a reduced set of aging modes that represent normal operation. As noted earlier, there are two methods for conducting this analysis, based on the data available.

(1) *Method 1—Direct clustering.* Use Method 1 when sufficient exhaust flow and temperature data are available directly from the field data. The data requirements for Method 1 are described in § 1065.1133(b)(1). The method involves three steps: clustering analysis, mode consolidation, and cycle building.

(i) The primary method for determining modes from a field data set involves the use of k-means clustering. K-means clustering is a method where a series of observations is partitioned into set of clusters of “similar” data points, where every observation is a member of a cluster with the nearest mean, which is referred to as the centroid of that cluster. The number of clusters is a parameter of the analysis, and the k-means algorithm generally seeks an optimal number of clusters to minimize the least-squares distance of all points to their respective centroids. There are a number of different commercially available software programs to perform k-means clustering, as well as freely available algorithm codes. K-means clustering can arrive at many different solutions, and we are providing the following guidance to help select the optimal solution for use in accelerated aging cycle generation. The process involves analyzing the data multiple time using an increasing number of clusters for each analysis. Use at least 5 clusters, and we recommend developing solutions for the range between 5 and 8 clusters, although you may use more if desired. Each cluster is a potential aging mode with a temperature and flow rate defined by the centroid. More clusters result in more aging modes, although this number may be reduced later via model consolidation.

(ii) The cubic clustering criteria (CCC) is a metric calculated for each solution having a different number of clusters.

The computation of CCC is complex and described in more detail in the following reference. The CCC computation is normally available as one of the metrics in commercially available software packages that can be used for k-means clustering. The optimal solution is typically the one with the number of clusters corresponding to the highest CCC.

(iii) Check each solution, starting with the one with the highest CCC to determine if it satisfies the following requirements:

(A) No more than one cluster contains fewer than 3% of the data points.

(B) The temperature ratio between the centroid with the maximum temperature and the centroid with the minimum temperature is at least 1.6 for clusters containing more than 3% of the data points.

(C) If that solution does not satisfy these requirements move to the solution with the next highest CCC.

(iv) The process described in paragraph (c)(1)(iii) of this section generally works well for most data sets, but if you have difficulty with the CCC

metric in a particular data set, use good engineering judgment to leverage additional criteria to help the down-selection process. Examples of alternate clustering metrics include a Davies-Bouldin Index (optimizing on the minimum value) or a Calinski-Harabasz Index (optimize on the maximum value).

(v) The initial candidate mode conditions are temperature and flow rate combinations that are the centroids for each cluster from the analysis in paragraph (c)(1)(iii) of this section. As part of the analysis, you must also determine the 10th percentile and 90th percentile temperatures for each cluster. These additional values may be needed later for the cycle heat load tuning process described in § 1065.1143.

(vi) The mode weight factor for a given cluster is the fraction of data points contained within that cluster.

(2) *Method 2—Cluster-based weighting of certification cycle modes.* Use Method 2 if there is insufficient exhaust flow and temperature data from the field at the time the cycle is being developed. The data requirements for

Method 2 are described in § 1065.1133(b)(2). You also need laboratory data recorded in the form of 1 Hz data sets for the regulatory duty cycles you are certifying to for your application as described in the standard setting part. Include exhaust flow rate and the inlet temperature for each key catalyst component in the laboratory data sets, as described in paragraph (e) of this section. The laboratory data sets must also include parameters that match the field data as described in § 1065.1133(b)(2), which will be used to facilitate the clustering analysis.

(i) Perform k-means clustering is described in § 1065.1133(b)(1) but using data sets containing the two parameters recorded in the field data sets. For example, you might use speed and torque, as recorded both in the field and the laboratory for Method 2 clustering.

(ii) Determine the fraction of points from each of the regulatory laboratory duty-cycles that are within each cluster, in addition to the overall fraction of points from the entire data set.

(iii) For each cycle, calculate a square sum error, *SSE*, as follows:

$$SSE = \sum_{i=1}^N (Cycle_{probi} - RefData_{probi})^2$$

Eq. 1065.1139-1

Where:

$i$  = an indexing variable that represents one cluster.

$N$  = total number of clusters.

$Cycle_{prob}$  = the fraction of points in a given cluster,  $i$ , for the regulatory duty-cycle of interest.

$RefData_{prob}$  = the fraction of points in a given cluster,  $i$ , for the full data set.

(iv) For each cycle, calculate a dissimilarity index as follows:

$$Dissimilarity = \sqrt{\frac{SSE}{N}}$$

Eq. 1065.1139-2

Where:

$SSE$  = sum square error from Eq. 1065.1139-2.

$N$  = total number of clusters.

(v) If you have more than one regulatory duty cycle, weight the regulatory cycles.

(A) Determine the weighting factors for a given regulatory cycle,  $w_i$ , by solving a system of equations:

$$w_i = \frac{1}{1 + \sum_{j \neq i} \frac{d_j}{d_i}}$$

Eq. 1065.1139-3

Where:

$d_i$  = dissimilarity for a given regulatory cycle,  $i$ .

$d_j$  = dissimilarity for a given regulatory cycle,  $j$ .

(B) For example, for three duty cycles, calculate  $w_1$  as follows:

$$w_1 = \frac{1}{1 + \frac{d_1}{d_2} + \frac{d_1}{d_3}}$$

Eq. 1065.1139-4

(C) Calculate subsequent  $w_i$  values after calculating  $w_1$  as follows:

$$w_i = w_1 \cdot \frac{d_1}{d_i}$$

Eq. 1065.1139-5

(D) Calculate the sum of the weighting factors to verify that they are equal to one.

$$w_1 + \dots + w_n = 1$$

Eq. 1065.1139-6

Where:

$n$  = number of regulatory cycles for the application.

(vi) For each regulatory cycle determine the average exhaust flow and the average inlet temperature for each key catalyst. Determine the 25th and 90th percentile inlet temperatures for the primary catalyst and the respective associated exhaust flow rate for each data point.

(vii) Use the cycle weights from paragraph (b)(2)(v) of this section and the mode conditions from paragraph (b)(2)(vi) of this section to generate a set of candidate aging modes by multiplying the cycle weight factor,  $w_{[cycle]}$  by 0.25 for the 25th percentile temperature mode, 0.65 for the 50th percentile temperature mode, and by 0.10 for the 90th percentile temperature mode. This will generate a weighted set of mode numbers three times the number of regulatory cycles for the target application. Each mode will have a target temperature and exhaust flow rate.

(viii) If you have only one regulatory cycle for your application, use the cycle modes and weighting factors as they are given in the standard setting part.

(3) *Determination of mode total durations.* The output for either method will be a set of mode exhaust conditions, with an associated weighting factor for each mode. Multiply the mode weight factors by the total number of normal operating (non-regenerating) hours, to get a target mode duration for each mode. This will be used in the heat load calculations.

(c) *Mode consolidation.* Sometimes the clustering analysis process will generate multiple modes that are very similar to each other in temperature, such that although they are distinct modes they will not have a significantly different impact on aftertreatment aging. To reduce the complexity of the aging cycle, you may consolidate modes that are similar into a single mode as described below.

(1) Consolidate any two or more modes which have a target temperature within 10 °C into a single mode. If you choose to do this, the target temperature of the single consolidated mode is the temperature associated with the highest weight factor mode before consolidation. If the modes being consolidated all have weighting factors within 0.05 of each other, use the highest temperature among the modes.

(2) Use the highest exhaust flow target among the modes being combined as the target exhaust flow for new consolidate mode.

(3) Use the combined sum of the weighting factors for all modes being consolidate as the weighting factor for the new consolidated mode. Similarly, the total duration of the new consolidated mode is the sum of the durations of the modes being consolidated.

(d) *Analysis of regeneration data.* Regeneration data is treated separately from the normal operating mode data. Generally, the target for accelerated aging cycle operation is to run all of the regenerations that would be expected over the course of useful life. If multiple types of regeneration are conducted on different system components, each type of regeneration must be analyzed separately using the steps in this paragraph (d). The data requirements for input into this process are described in § 1065.1133(b)(3). The process described below is meant to determine a representative regeneration profile that will be used during aging. You may also ask us to allow the use of other engineering data or analysis to determine a representative regeneration profile.

(1) The total number of regenerations that will be run during the accelerated aging process will be the same as the total number of regenerations over useful life. Calculate this number by dividing the total number of useful life hours by the interval between regenerations as determined in § 1065.1133(b)(3).

(2) Use the 1 Hz regeneration data to determine an appropriate regeneration profile. The recorded regeneration event begins when the engine indicates it has started regeneration using the recorded regeneration indicator and ends when the aftertreatment has returned back to the normal operating temperature after the flag indicates the regeneration is complete.

(3) For each recorded regeneration, calculate the cumulative deactivation,  $D_i$ , using the equations in paragraph (e) of this section.

(4) If you have a large number of recorded regenerations in your data set, select a regeneration event with a cumulative deactivation representing the 75th percentile of the distribution of heat loads in your recorded data set. If you have a smaller number of recorded regenerations, such that you cannot clearly identify the real distribution, select the recorded regeneration with the highest recorded cumulative deactivation.

(5) This regeneration event will be used as the regeneration profile for that type of event during aging. The profile should include the entire event, include the temperature ramp and cool-down period.

(6) The regeneration must be conducted in the same manner as it is run in the field. For instance, if the regeneration temperature is generated from an exothermic reaction by injecting fuel in front of a DOC, this methodology should also be used during bench aging.

(7) If part of the system is at a lower temperature during regeneration because it is upstream of the temperature generating component, the set the target temperature for the aftertreatment system inlet to be equivalent to the system inlet temperature used during the highest duration non-regeneration mode, or 350 °C, whichever is lower.

(e) *Heat load calculation and tuning for systems that have regeneration events.* Perform this procedure after the preliminary cycles are completed for both normal and regeneration operation. The target cumulative deactivation is determined from the input field data, and then a similar calculation is performed for the preliminary aging cycle. If the cumulative deactivation for the preliminary cycle does not match

cumulative deactivation from the field data, then the cycle is tuned over a series of steps until the target is matched.

(1) The deactivation for a given catalyst is calculated for each time step as follows:

$$D_i = e^{\left(\frac{E_a}{R}\right) \cdot \left(\frac{1}{T_{std}} - \frac{1}{T+273.15}\right)}$$

Eq. 1065.1139-7

Where:

$D_i$  = incremental deactivation for time step  $i$ .  
 $E_a$  = thermal reactivity coefficient for the catalyst as determined in § 1065.1137.

$R$  = molar gas constant in kJ/mol·K.

$T_{std}$  = standard temperature = 293.15 K.

$T$  = catalyst temperature in K.

(2) Calculate the cumulative deactivation,  $D_t$ , for a given catalyst over a series of time steps,  $N$ , using the following equation:

$$D_t = \sum_{i=0}^N D_i$$

Eq. 1065.1139-8

Where:

$i$  = an indexing variable that represents one time step.

$N$  = total number of cumulative deactivation time steps in the data set.

$D_i$  = incremental deactivation for each time step.

(3) Calculate the cumulative deactivation,  $D_t$ , for the input field data set. The time step for the calculations should be 1 second for 1-Hz input data.

(i) First calculate  $D_t$  for the non-regeneration portion of the field data set. For Method 2 use the 1-Hz data from the regulatory cycles as the field data set.

(ii) Divide the calculate field  $D_t$  by the number of hours represented in the field data set.

(iii) Multiply the hourly  $D_t$  by the number of hours required to reach full useful life. This is the target  $D_{t,field-norm}$ .

(iv) Multiply the total number of regenerations for full useful life by the cumulative deactivation  $D_t$  for the target regeneration profile determined in paragraph (d)(4) of this section. This is the target  $D_{t,field-regen}$ .

(v) The total target cumulative deactivation for the field data,  $D_{t,field}$ , is the sum of  $D_{t,field-norm}$  and  $D_{t,field-regen}$ .

(4) Calculate the cumulative deactivation for the candidate aging cycle generated under paragraphs (c) and (d) of this section as follows:

(i) Using the modes and mode durations for normal operation generated in paragraph (c) of this section, calculate the cumulative deactivation,  $D_{t,cycle-norm}$ , using the

method given in paragraph (e)(2) of this section.

(ii) The total cumulative deactivation for the candidate aging cycle,  $D_t$ , is the sum of  $D_{t,cycle-norm}$  and  $D_{t,field-regen}$ .

(5) If  $D_{t,cycle}$  is within  $\pm 1\%$  of  $D_{t,field}$ , the candidate cycle is deemed representative and may be used for aging.

(6) If  $D_{t,cycle}$  is not within  $\pm 1\%$  of  $D_{t,field}$ , the candidate cycle must be adjusted to meet this criterion using the following steps. It should be noted that if the  $D_{t,cycle}$  is outside of the criteria it will usually be lower than the  $D_{t,field}$ .

(i) Increase the duration of the stable portion of the regeneration profile, which is defined as the portion of the regeneration profile where the temperature has completed ramping and is being controlled to a stationary target temperature. Note that this will increase the number of hours of regeneration time. You must compensate for this by decreasing the total number of normal operation (non-regeneration) hours in the cycle. Recalculate the duration of all the normal operation modes. You may not increase the duration of the stable portion of the regeneration profile by more than a factor of 2. If you reach this limit and you still do not meet the criteria in paragraph (e)(5) of this section, proceed to the next step.

(ii) Increase the target temperature of the stable portion of the regeneration profile by the amount necessary to reach the target criteria. You may not increase this temperature higher than the temperature observed in the regeneration profile with the highest  $D_t$  observed in the field. If you reach this limit and you still do not meet the criteria in paragraph (e)(5) of this section, proceed to the next step.

(iii) Increase the target temperature of the highest temperature normal operation mode. You may not increase this temperature above the 90th percentile determined in paragraph (b)(1)(v) of this section for Method 1, or above the maximum temperature for the regulatory cycle from which the mode was derived for Method 2. If you reach this limit and you still do not meet the criteria in paragraph (e)(5) of this section, you may repeat this step using the next highest temperature mode, until you reach the target, or all modes have been adjusted.

(iv) If you are unable to reach the target deactivation by following paragraphs (e)(6)(i) through (iii) of this section, use good engineering judgment to increase the number of regenerations to meet the criteria in paragraph (e)(5) of this section. Note that this will increase the total regeneration hours, therefore you must decrease the number

of normal operation hours and recalculate mode durations for the normal operation modes.

(f) *Heat load calculation and tuning for systems that do not have regeneration events.* Follow the steps described for systems with regeneration events to calculate  $D_{t,field}$  and  $D_{t,cycle}$ , omitting the steps related to regeneration events. The  $D_{t,cycle}$  will be well below the  $D_{t,field}$ . Follow the steps given below to adjust the cycle until you meet the criteria in paragraph (e)(5) of this section.

(1) Increase the temperature of the highest temperature mode. Use good engineering judgment to ensure that this temperature does not exceed the limits of the catalyst in a way that might cause rapid deactivation or failure via a mechanism that is not considered normal degradation.

(2) Increase the duration of the highest temperature mode and decrease the duration of the other modes in proportion. You may not increase the duration highest temperature mode by more than a factor of 2.

(g) *Final aging cycle assembly.* The final step of aging cycle development is the assembly of the actual cycle based on the mode data from either paragraph (e) of this section for systems with infrequent regeneration, or paragraph (f) of this section for systems that do not incorporate infrequent regeneration. This cycle will repeat a number of times until the total target aging duration has been reached.

(1) *Cycle assembly with infrequent regenerations.* For systems that use infrequent regenerations, the number of cycle repeats is equal to the number of regeneration events that happen over full useful life. The infrequent regenerations are placed at the end of the cycle. The total cycle duration of the aging cycle is calculated as the total aging duration in hours divided by the number of infrequent regeneration events. In the case of systems with multiple types of infrequent regenerations, use the regeneration with the lowest frequency to calculate the cycle duration.

(i) If you have multiple types of infrequent regenerations, arrange the more frequent regenerations such that they are spaced evenly throughout the cycle.

(ii) Determine the length of the normal (non-regeneration) part of the cycle by subtracting the regeneration duration, including any regeneration extension determined as part of cycle tuning from paragraph (e) of this section, from the total cycle duration. If you have multiple types of regeneration, then the combined total duration of

regeneration events performed in the cycle must be subtracted from the total. For example, if you have one type of regeneration that is performed for 30 minutes every 30 cycle hours, and a second type that is performed for 30 minutes every 10 cycle hours (such that 3 of these secondary events will happen during each cycle), then you would subtract a total of 2 hours of regeneration time from the total cycle duration considering all 4 of these events.

(iii) Divide the duration of the normal part of the cycle into modes based on the final weighting factors determined in paragraph (c) of this section following any mode consolidation.

(iv) Place the mode with the lowest temperature first, then move to the highest temperature mode, followed by the next lowest temperature mode, and then the next highest mode, continuing in this alternating pattern until all modes are included.

(v) Transition between normal modes within (60 to 300) seconds. The transition period is considered complete when you are within  $\pm 5$  °C of the target temperature for the primary key component. Transitions may follow any pattern of flow and temperature to reach this target within the required 300 seconds.

(vi) For normal modes longer than 30 minutes, you may count the transition time as time in mode. Account for the transition time for modes shorter than 30 minutes by shortening the duration of the longest mode by an equivalent amount of time.

(vii) If the shortest normal operating mode is longer than 60 minutes, you must divide the normal cycle into shorter sub-cycles with the same pattern in paragraph (g)(1)(iii) of this section, but with shorter durations, so that the pattern repeats two or more times. You must divide the cycle into sub-cycles until the duration of the shortest mode in each sub-cycle is no longer than 30 minutes. No mode may have a duration shorter than 15 minutes, not including transition time.

(viii) If a regeneration event is scheduled to occur during a normal mode, shift the start of regeneration to the end of the nearest normal mode.

(2) *Cycle assembly without infrequent regenerations.* For systems that do not use infrequent regenerations, the cycle will be arranged to achieve as much thermal cycling as possible using the following steps.

(i) Assign a duration of 15 minutes to the mode with the lowest weight factor. Calculate the duration of the remaining modes in proportion to the final weight factors after mode durations have been



adjusted during heat load tuning in paragraph (f) of this section.

(ii) Place the mode with the lowest temperature first, then move to the highest temperature mode, followed by the next lowest temperature mode, and then the next highest mode, continuing in this alternating pattern until all modes are included.

(iii) Transition between normal modes within (60 to 300) seconds. The transition period is considered complete when you are within ±5 °C of the target temperature for the primary key component. Transitions may follow any pattern of flow and temperature to reach this target within the required 300 seconds.

(iv) For normal modes longer than 30 minutes, you may count the transition time as time in mode. Account for the transition time for modes shorter than 30 minutes by shortening the duration

of the longest mode by an equivalent amount of time.

(v) This cycle will be repeated the number of times necessary to reach the target aging duration.

(h) *Determination of accelerated oil exposure targets.* The target oil exposure rate during accelerated aging is 10 times the field average oil consumption rate determined in § 1065.1133(a)(2). You must achieve this target exposure rate on a cycle average basis during aging. Use good engineering judgment to determine the oil exposure rates for individual operating modes that will achieve this cycle average target. For engine-based aging stands you will likely have different oil consumption rates for different modes depending on the speed and load conditions you set. For burner-based aging stands, you may find that you have to limit oil exposure rates at low exhaust flow or low temperature modes to ensure good

atomization of injected oil. On a cycle average basis, the portion of oil exposure from the volatile introduction pathway (*i.e.*, oil doped in the burner or engine fuel) must be between (10 to 30)% of the total. The remainder of oil exposure must be introduced through bulk pathway.

(1) *Determination of accelerated fuel sulfur exposure targets.* The target sulfur exposure rate for fuel-related sulfur is determined by utilizing the field mean fuel rate data for the engine determined in § 1065.1133(a)(3). Calculate the total sulfur exposure mass using this mean fuel rate, the total number of non-accelerated hours to reach full useful life, and a fuel sulfur level of 10 ppmw.

(i) For an engine-based aging stand, if you perform accelerated sulfur exposure by adding engine fuel to a higher sulfur level, determine the accelerated aging target additized fuel sulfur mass fraction,  $w_s$ , as follows:

$$w_{S,target} = \frac{\bar{m}_{fuel,field}}{\bar{m}_{fuel,cycle}} \cdot m_{Sfuel,ref} \cdot S_{acc,rate}$$

Eq. 1065.1139-9

Where:

$\bar{m}_{fuel,field}$  = field mean fuel flow rate.

$\bar{m}_{fuel,cycle}$  = accelerated aging cycle mean fuel flow rate.

$m_{Sfuel,ref}$  = reference mass of sulfur per mass of fuel = 0.00001 kg/kg

$S_{acc,rate}$  = sulfur acceleration rate = 10

*Example:*

$\bar{m}_{fuel,field}$  = 54.3 kg/hr

$\bar{m}_{fuel,cycle}$  = 34.1 kg/hr

$m_{Sfuel,ref}$  = 0.00001 kg/kg.

$S_{acc,rate}$  = 10.

$$w_{S,target} = \frac{54.3}{34.1} \cdot 0.00001 \cdot 10$$

$w_{S,target} = 0.000159$

(ii) If you use gaseous SO<sub>2</sub> to perform accelerated sulfur exposure, such as on a burner-based stand, calculate the target SO<sub>2</sub> concentration to be introduced,  $x_{SO2,target}$ , as follows:

$$x_{SO2,target} = \frac{\bar{m}_{fuel,field}}{\bar{m}_{exhaust,cycle}} \cdot \left( \frac{x_{Sfuel,ref} \cdot S_{acc,rate} \cdot M_{exh}}{M_S} \right)$$

Eq. 1065.1139-10

Where:

$\bar{m}_{fuel,field}$  = field mean fuel flow rate.

$\bar{m}_{exhaust,cycle}$  = mean exhaust flow rate during the burner aging cycle.

$x_{Sfuel,ref}$  = reference mol fraction of sulfur in fuel = 10 μmol/mol.

$S_{acc,rate}$  = sulfur acceleration rate = 10.

$M_{exh}$  = molar mass of exhaust = molar mass of air.

$M_S$  = molar mass of sulfur.

*Example:*

$\bar{m}_{fuel,field}$  = 54.3 kg/hr

$\bar{m}_{exhaust,cycle}$  = 1000.8 kg/hr

$x_{Sfuel,ref}$  = 10 μmol/mol

$S_{acc,rate}$  = 10

$M_{exh}$  = 28.96559 g/mol

$M_S$  = 32.065 g/mol

$$x_{SO2,target} = \frac{54.3}{1000.8} \cdot \left( \frac{10 \cdot 10 \cdot 28.96559}{32.065} \right)$$

$x_{SO2,target} = 4.90$  μmol/mol

(iii) You may choose to turn off gaseous sulfur injection during infrequent regeneration modes, but if you do you must increase the target SO<sub>2</sub> concentration by the ratio of total aging

time to total normal (non-regeneration) aging time.

(2) [Reserved]

**§ 1065.1141 Facility requirements for engine-based aging stands.**

An engine-based accelerated aging platform is built around the use of a compression-ignition engine for generation of heat and flow. You are not

required to use the same engine as the target application that is being aged. You may use any compression-ignition engine as a bench aging engine, and the engine may be modified as needed to support meeting the aging procedure requirements. You may use the same bench aging engine for deterioration factor determination from multiple engine families. The engine must be capable of reaching the combination of temperature, flow, NO<sub>x</sub>, and oil consumption targets required. We recommend using an engine platform larger than the target application for a given aftertreatment system to provide more flexibility to achieve the target conditions and oil consumption rates. You may modify the bench aging engine controls in any manner necessary to help reach aging conditions. You may bypass some of the bench aging engine exhaust around the aftertreatment system being aged to reach targets, but you must account for this in all calculations and monitoring to ensure that the correct amount of oil and sulfur are reaching the aftertreatment system. If you bypass some of the engine exhaust around the aftertreatment system, you must directly measure exhaust flow rate through the aftertreatment system. You may dilute bench aging engine exhaust prior to introduction to the aftertreatment system, but you must account for this in all calculations and monitoring to ensure that the correct engine conditions and the correct amount of oil and sulfur are reaching the aftertreatment system. Your engine-based aging stand must incorporate the following capabilities:

(a) Use good engineering judgment to incorporate a means of controlling temperature independent of the engine. An example of such a temperature control would be an air-to-air heat exchanger. The temperature control system must be designed to prevent condensation in the exhaust upstream of the aftertreatment system. This independent temperature control is necessary to provide the flexibility required to reach temperature, flow, oil consumption targets, and NO<sub>x</sub> targets.

(b) Use good engineering judgment to modify the engine to increase oil consumption rates to levels required for accelerated aging. These increased oil consumption levels must be sufficient to reach the bulk pathway exposure targets determined in § 1065.1139(h). A combination of engine modifications and careful operating mode selection will be used to reach the final bulk pathway oil exposure target on a cycle average. You must modify the engine in a fashion that will increase oil

consumption in a manner such that the oil consumption is still generally representative of oil passing the piston rings into the cylinder. Use good engineering judgment to break in the modified engine to stabilize oil consumption rates. We recommend the following methods of modification (in order of preference):

(1) Install the top compression rings inverted (upside down) on all the cylinders of the bench aging engine.

(2) If the approach in paragraph (b)(1) of the section is insufficient to reach the targets, modify the oil control rings in one or more cylinders to create small notches or gaps (usually no more than 2 per cylinder) in the top portion of the oil control rings that contact the cylinder liner (care must be taken to avoid compromising the structural integrity of the ring itself).

(c) We recommend that the engine-aging stand include a constant volume oil system with a sufficiently large oil reservoir to avoid oil “top-offs” between oil change intervals.

(d) If the engine-aging stand will be used for aging of systems that perform infrequent regenerations, the aging stand must incorporate a means of increasing temperature representative of the target application. For example, if the target application increases temperature for regeneration by introducing fuel into the exhaust upstream of an oxidation catalyst, the aging stand must incorporate a similar method of introducing fuel into the exhaust.

(e) If the engine-aging stand will be used for aging systems that incorporate SCR-based NO<sub>x</sub> reduction, the aging stand must incorporate a representative means of introducing DEF at the appropriate location(s).

(f) Use good engineering judgment to incorporate a means of monitoring oil consumption on at least a periodic basis. You may use a periodic drain and weigh approach to quantify oil consumption. You must validate that the aging stand reaches oil consumption targets prior to the start of aging. You must verify oil consumption during aging prior to each emission testing point, and at each oil change interval. Validate or verify oil consumption over a running period of at least 72 hours to obtain a valid measurement. If you do not include the constant volume oil system recommended in paragraph (c) of this section, you must account for all oil additions.

(g) Use good engineering judgment to establish an oil change interval that allows you to maintain relatively stable oil consumption rates over the aging process. Note that this interval may be

shorter than the normal recommended interval for the engine due to the modifications that have been made.

(h) If the engine-aging stand will be used for aging of systems that incorporate a diesel particulate filter (DPF), we recommend you perform secondary tracking of oil exposure by using clean (soot free) DPF weights to track ash loading and compare this mass of ash to the amount predicted using the measured oil consumption mass and the oil ash concentration. The mass of ash found by DPF weight should fall within (55 to 70)% of the of mass predicted from oil consumption measurements.

(i) Incorporate a means of introducing lubricating oil into the engine fuel to enable the volatile pathway of oil exposure. You must introduce sufficient oil to reach the volatile pathway oil exposure targets determined in paragraph (h) of this section. You must measure the rate of volatile pathway oil introduction on a continuous basis.

(j) If you perform sulfur acceleration by increasing the sulfur level of the engine fuel, you must meet the target sulfur level within  $\pm 5$  ppmw. Verify the sulfur level of the fuel prior to starting aging, or whenever a new batch of aging fuel is acquired.

(k) If you use gaseous SO<sub>2</sub> for sulfur acceleration, you must incorporate a means to introduce the gaseous SO<sub>2</sub> upstream of the aftertreatment system. Use good engineering judgment to ensure that gaseous SO<sub>2</sub> is well mixed prior to entering the aftertreatment system. You must monitor the rate of gaseous SO<sub>2</sub> introduction on a continuous basis.

#### **§ 1065.1143 Requirements for burner-based aging stands.**

A burner-based aging platform is built using a fuel-fired burner as the primary heat generation mechanism. The burner must utilize diesel fuel and it must produce a lean exhaust gas mixture. You must configure the burner system to be capable of controlling temperature, exhaust flow rate, NO<sub>x</sub>, oxygen, and water to produce a representative exhaust mixture that meets the accelerated aging cycle targets for the aftertreatment system to be aged. You may bypass some of the bench aging exhaust around the aftertreatment system being aged to reach targets, but you must account for this in all calculations and monitoring to ensure that the correct amount of oil and sulfur are reaching the aftertreatment system. The burner system must incorporate the following capabilities:

(a) Directly measure the exhaust flow through the aftertreatment system being aged.

(b) Ensure transient response of the system is sufficient to meet the cycle transition time targets for all parameters.

(c) Incorporate a means of oxygen and water control such that the burner system is able to generate oxygen and water levels representative of compression-ignition engine exhaust.

(d) Incorporate a means of oil introduction for the bulk pathway. You must implement a method that introduces lubricating oil in a region of the burner that does not result in complete combustion of the oil, but at the same time is hot enough to oxidize oil and oil additives in a manner similar to what occurs when oil enters the cylinder of an engine past the piston rings. Care must be taken to ensure the oil is properly atomized and mixed into the post-combustion burner gases before they have cooled to normal exhaust temperatures, to insure proper digestion and oxidation of the oil constituents.

You must measure the bulk pathway oil injection rate on a continuous basis. You must validate that this method produces representative oil products using the secondary method in § 1065.1141(h) regardless of whether you will use the burner-based aging stand to age systems which include a DPF. Use good engineering judgment to select a DPF for the initial validation of the system. Perform this validation when the burner-based aging stand is first commissioned or if any system modifications are made that affect the oil consumption introduction method. We also recommend that you examine ash distribution on the validation DPF in comparison to a representative engine aged DPF.

(e) Incorporate a means of introducing lubricating oil into the burner fuel to enable the volatile pathway of oil exposure. You must introduce sufficient oil to reach the volatile pathway oil exposure targets determined in § 1065.1139(h). You must measure the rate of volatile pathway oil introduction on a continuous basis.

(f) If the burner-based aging stand will be used for aging of systems that perform infrequent regenerations, the aging stand must incorporate a means of increasing temperature representative of the target application. For example, if the target application increases temperature for regeneration by introducing fuel into the exhaust upstream of an oxidation catalyst, the aging stand must incorporate a similar method of introducing fuel into the exhaust.

(g) If the burner-based aging stand will be used for aging of systems that incorporate SCR-based NO<sub>x</sub> reduction, the aging stand must incorporate a

representative means of introducing DEF at the appropriate location(s).

(h) If the burner-based aging stand will be used for aging of systems that incorporate a diesel particulate filter (DPF), we recommend you perform secondary tracking of oil exposure by using clean (soot free) DPF weights to track ash loading and compare this mass of ash to the amount predicted using the measured oil consumption mass and the oil ash concentration. The mass of ash found by DPF weight should fall within (55 to 70)% of the of mass predicted from oil consumption measurements.

(i) You must incorporate a means to introduce the gaseous SO<sub>2</sub> upstream of the aftertreatment system. Use good engineering judgment to ensure that gaseous SO<sub>2</sub> is well mixed prior to entering the aftertreatment system. You must monitor the rate of gaseous SO<sub>2</sub> introduction on a continuous basis.

**§ 1065.1145 Execution of accelerated aging, cycle tracking, and cycle validation criteria.**

The aging cycle generally consists first of practice runs to validate and tune the final cycle, followed by the actual running of the repeat cycles needed to accumulate field equivalent hours to reach full useful life. During the course of the aging run, various aging parameters are tracked to allow verification of proper cycle execution, as well as to allow for correction of the aging parameters to stay within the target limits.

(a) *Preliminary cycle validation runs.* Prior to the start of aging, conduct a number of practice runs to tune the cycle parameters. It is recommended that initial practice runs be conducted without the aftertreatment installed, but with the backpressure of the aftertreatment simulated to help ensure that the tuned cycle is representative. For final cycle tuning, including regenerations, it is recommended to use a duplicate or spare aftertreatment system of similar design to the target system, to avoid damage or excessive initial aging during the tuning. However, it is permissible to conduct final tuning using the target system being aged, but you must limit the total duration to no more than 100 field equivalent hours (10 hours of accelerated aging), including both thermal and chemical components. The process followed for these initial runs will vary depending on whether you are using an engine-based platform or a burner-based platform.

(1) *Engine-based platform.* (i) *Initial cycle development.* It will be necessary to determine a set of engine modes that will generate the required combinations

of temperature, exhaust flow, oil consumption, and NO<sub>x</sub> to meet the target aging requirements. The development of these modes will be an iterative process using the engine and independent temperature control features of the aging stand. This process assumes that you have already implemented the oil consumption increase modifications, and that these have already been stabilized and validated to reach the necessary levels of bulk oil exposure. In general, we recommend the use of higher engine speeds and loads to generate the desired oil consumption, leveraging the temperature controls as needed to lower temperature to the targets. Several iterations will likely be needed to reach all targets. Note that during transitions you may utilize any combination of conditions necessary to help primary component catalysts reach the target temperature and flow conditions within no more than 5 minutes. For example, you may use a higher exhaust flow rate and lower temperature to rapidly cool the aftertreatment system to the next temperature. NO<sub>x</sub> targets do not need to be met during transitions. It is permissible to deviate from engine-out NO<sub>x</sub> emission targets if needed to reach the temperature, exhaust flow, and oil consumption targets. We recommend that you maintain a NO<sub>x</sub> level that is at the target level or higher, but you may lower NO<sub>x</sub> by up to 25%, if necessary, on some modes. Note that validation of oil consumption requires at least 72 hours of operation. Tune the parameters for infrequent regeneration towards then end of this initial development process (such as hydrocarbon injection schedules and temperature ramp rates).

(ii) *Final cycle validation.* Once the cycle is tuned, conduct a final run using the target aftertreatment system to verify conditions and log temperatures for heat load calculation. Using the recorded cycle data, calculate  $D_i$  for all primary component catalysts to ensure that you are matching the desired  $D_{i,cycle}$  targets. If you are not within  $\pm 3\%$  of the target  $D_{i,cycle}$ , adjust the cycle accordingly. Calculate  $D_i$  for any secondary catalyst components to verify that they are within  $\pm 3\%$  of either the target  $D_i$  or the target aging metric. Note that the accelerated aging methodology assumes that the relationship between the temperature of the primary and secondary catalyst components will be the same as the field observations. If this relationship deviates in the lab by having more or less heat transfer through the system, it may be necessary to modify that relationship on the aging stand. You may need to take measures

such as adding or removing insulation or utilize external cooling fans to help these parameters match more closely.

(2) *Burner-based platform.* (i) *Cycle development.* The burner-based platform will be able to meet the exhaust flow, temperature, NO<sub>x</sub>, and oil consumption targets directly without the need for additional cycle development. This process assumes that you have already implemented and validated your oil consumption exposure methods to reach the necessary levels of bulk oil exposure. In addition, you must meet the oxygen and water targets during aging modes within  $\pm 2\%$  for oxygen and  $\pm 2\%$  for water. Note that during transitions you may utilize any combination of conditions necessary to help primary component catalysts reach the target temperature and flow conditions within no more than 5 minutes. For example, you may use a higher exhaust flow rate and lower temperature to rapidly cool the aftertreatment system to the next temperature. NO<sub>x</sub>, oxygen, and water targets do not need to be met during transitions.

(ii) *Final cycle validation.* Once the cycle is tuned, conduct a final run using the target aftertreatment system to verify conditions and log temperatures for heat load calculation. Using the recorded cycle data, calculate  $D_t$  for all primary components catalysts to ensure that you are matching the desired  $D_{t,cycle}$  targets. If you are not within  $\pm 3\%$  of the target  $D_{t,cycle}$ , adjust the cycle accordingly. Calculate  $D_t$  for any secondary catalyst components to check that they are within  $\pm 3\%$  of either the target  $D_t$  or the target aging metric. Note that the accelerated aging methodology assumes that the relationship between the temperature of the primary and secondary catalyst components will be the same as that observed in the field. If this relationship deviates in the lab by having more or less heat transfer through the system, it may be necessary to modify that relationship on the aging stand. You may need to take measures such as adding or removing insulation or utilize external cooling fans to help these parameters match more closely.

(b) *Aftertreatment break in.* Break in the emission-data engine and aftertreatment prior to the initial zero-hour test by running both on an engine dynamometer as described in subpart E of this part. Use good engineering judgment to develop a representative cycle that represents the field data. You may use the same data used for accelerated aging cycle development or other data. If your system utilizes infrequent regeneration, include at least one complete regeneration event, but we

recommend that you include at least two such events to stabilize emissions performance. Your break in process must include at least 125 hours of engine operation with the aftertreatment system. You may ask to use a longer break in duration based on good engineering judgment, to ensure that emission performance is stabilized prior to the zero-hour testing.

(c) *Initial emission testing.* Prior to the start of accelerated aging conduct the initial zero-hour emission test and any required engine dynamometer aging following the requirements of the standard setting part for your engine. Dynamometer aging hours count toward the total aging hours.

(d) *Accelerated aging.* Following zero-hour emission testing and any engine dynamometer aging, perform accelerated aging using the cycle validated in either paragraph (a)(1) or (2) of this section. Repeat the cycle the number of times required to reach full useful life equivalent aging. Interrupt the aging cycle as needed to conduct any scheduled intermediate emission tests, clean the DPF of accumulated ash, and for any facility related reasons. We recommend you interrupt aging at the end of a given aging cycle, following the completion of any scheduled infrequent regeneration event.

(e) *QA tracking and validation.* During aging, track a number of aging parameters to ensure that fall within the required limits. Correct aging parameters as need to remain within the required control limits.

(1) *Thermal load tracking.* For each primary catalyst component, generate a target line which describes the relationship between aging hours on the cycle and cumulative deactivation,  $D_t$ . Generate control limit lines that are  $\pm 3\%$  of the target line. You must remain within these control limits over the course of aging. Adjust aging parameters as needed to remain within these limits for the primary catalyst components. For each secondary catalyst component, generate both a target  $D_t$  line and a line describing the target behavior of the aging metric directly. You must remain within either  $\pm 10\%$  of either the  $D_t$  line or  $\pm 3\%$  of the aging metric target line for any secondary catalyst component. Adjust aging parameters as needed to remain within these limits noting that you must remain within limits for the primary components. Adjusting the secondary catalyst aging may require altering heat transfer through the system to make it more representative of the field aging.

(2) *Oil consumption tracking.* Generate a target oil consumption line for both the bulk and volatile pathway

which describes the relationship between oil exposure and aging hours on the cycle. For the engine-based stand the control limits are  $\pm 10\%$  for total oil consumption, noting that the volatile pathway must not exceed 30% of the total. For the burner-based stand, the controls limits are  $\pm 5\%$  for both pathways, which are tracked separately.

(i) *Changing engine oil.* For an engine-based platform, periodically change engine oil to maintain stable oil consumption rates and maintain the health of the aging engine. Interrupt aging as needed to perform oil changes. Perform a drain-and-weigh measurement. Following an oil change you must run at least 4 hours with the exhaust bypassing the aftertreatment system to stabilize the new oil. If you see a sudden change in oil consumption it may be necessary to stop aging and either change oil or correct an issue with the accelerated oil consumption. If the aging engine requires repairs to correct an oil consumption issue in the middle of aging, you must re-validate the oil consumption rate for 72 hours before you continue aging. The engine exhaust should be left bypassing the aftertreatment system until the repaired engine has been validated.

(ii) *Secondary oil consumption validation.* If your aftertreatment includes a diesel particulate filter, we recommend that you perform secondary validation of oil consumption by using clean (soot free) DPF weights to track ash loading and compare this mass of ash to the amount predicted using the measured oil consumption mass and the oil ash concentration. The mass of ash found by DPF weight should fall within a range of (55 to 70)% of the of mass predicted from oil consumption measurements. Perform this validation at the end of aging, at any intermediate emission test points, and at any point where you need to clean the DPF of accumulated ash in according with recommended maintenance.

(iii) *Sulfur tracking.* Generate a fuel sulfur exposure line describing the relationship between aging hours and cumulative target sulfur exposure mass. The control limits for sulfur exposure are  $\pm 3\%$ . Log actual fuel consumption and the measured fuel sulfur level of the current batch of fuel (if you are doping fuel to accelerate sulfur exposure) for engine stand aging. Use these measurements to ensure that sulfur exposure remains within the control limits. Adjust sulfur doping levels in the fuel from batch to batch as needed to stay within limits. If you use gaseous SO<sub>2</sub> for sulfur acceleration, monitor the mass flow rate of the gaseous sulfur. Use these measurements to calculate total

sulfur mass exposure, and correct SO<sub>2</sub> gas flow rates as needed to stay within the control limits.

(f) *Emission testing at intermediate and final test points.* Conduct emission testing at the end of aging and at any intermediate emission test points as described in the standard setting part. Following installation of the aged aftertreatment system on the emission-data engine at intermediate or final test points, prior to the start of emission testing, use good engineering judgment to operate the engine and aftertreatment system for a number of hours to stabilize emission controls and to allow any adaptive controls to update. Declare the number of stabilization hours prior to the start of the accelerated aging program.

**PART 1066—VEHICLE—TESTING PROCEDURES**

■ 269. The authority citation for part 1066 continues to read as follows:

Authority: 42 U.S.C. 7401–7671q.

■ 270. Amend § 1066.110 by revising paragraphs (b)(1)(vi), (b)(2)(i) and (b)(2)(v) introductory text to read as follows:

**§ 1066.110 Equipment specifications for emission sampling systems.**

\* \* \* \* \*

- (b) \* \* \*
- (1) \* \* \*

(vi) You must seal your system to the extent necessary to ensure that any remaining leaks do not affect your ability to demonstrate compliance with the applicable standards in this chapter. We recommend that you seal all known leaks.

\* \* \* \* \*

- (2) \* \* \*

(i) For PM background measurement, the following provisions apply in addition to the provisions in 40 CFR 1065.140(b):

\* \* \* \* \*

(v) If you choose to dilute the exhaust by using a remote mix tee, which dilutes the exhaust at the tailpipe, you may use the following provisions consistent with good engineering judgment, as long as they do not affect your ability to demonstrate compliance with the applicable standards in this chapter:

\* \* \* \* \*

■ 271. Amend § 1066.220 by revising paragraph (b) to read as follows:

**§ 1066.220 Linearity verification for chassis dynamometer systems.**

\* \* \* \* \*

(b) *Performance requirements.* If a measurement system does not meet the applicable linearity criteria in Table 1 of

this section, correct the deficiency by recalibrating, servicing, or replacing components as needed. Repeat the linearity verification after correcting the deficiency to ensure that the measurement system meets the linearity criteria. Before you may use a measurement system that does not meet linearity criteria, you must demonstrate to us that the deficiency does not adversely affect your ability to demonstrate compliance with the applicable standards in this chapter.

\* \* \* \* \*

■ 272. Amend § 1066.301 by revising paragraph (b) to read as follows:

**§ 1066.301 Overview of road-load determination procedures.**

\* \* \* \* \*

(b) The general procedure for determining road-load force is performing coastdown tests and calculating road-load coefficients. This procedure is described in SAE J1263 and SAE J2263 (incorporated by reference in § 1066.1010). Continued testing based on the 2008 version of SAE J2263 is optional, except that it is no longer available for testing starting with model year 2026. This subpart specifies certain deviations from those procedures for certain applications.

\* \* \* \* \*

■ 273. Amend § 1066.415 by revising paragraph (e)(2) to read as follows:

**§ 1066.415 Vehicle operation.**

\* \* \* \* \*

- (e) \* \* \*

(2) If vehicles have features that preclude dynamometer testing, you may modify these features as necessary to allow testing, consistent with good engineering judgment, as long as it does not affect your ability to demonstrate that your vehicles comply with the applicable standards in this chapter. Send us written notification describing these changes along with supporting rationale.

\* \* \* \* \*

■ 274. Amend § 1066.420 by revising paragraph (b) to read as follows:

**§ 1066.420 Test preparation.**

\* \* \* \* \*

(b) Minimize the effect of nonmethane hydrocarbon contamination in the hydrocarbon sampling system for vehicles with compression-ignition engines as follows:

(1) For vehicles at or below 14,000 pounds GVWR, account for contamination using one of the following methods:

(i) Introduce zero and span gas during analyzer calibration using one of the following methods, noting that the

hydrocarbon analyzer flow rate and pressure during zero and span calibration (and background bag reading) must be exactly the same as that used during testing to minimize measurement errors:

(A) Close off the hydrocarbon sampling system sample probe and introduce gases downstream of the probe making sure that you do not pressurize the system.

(B) Introduce zero and span gas directly at the hydrocarbon sampling system probe at a flow rate greater than 125% of the hydrocarbon analyzer flow rate allowing some gas to exit probe inlet.

(ii) Perform the contamination verification in paragraph (b)(2) of this section, except use 0.5 μmol/mol in 40 CFR 1065.520(f)(8)(iii).

(2) For vehicles above 14,000 pounds GVWR, verify the amount of nonmethane hydrocarbon contamination as described in 40 CFR 1065.520(f).

\* \* \* \* \*

■ 275. Amend § 1066.710 by revising the introductory text and paragraph (b)(1), removing Figure 1 of § 1066.710, and adding paragraph (f) to read as follows:

**§ 1066.710 Cold temperature testing procedures for measuring CO and NMHC emissions and determining fuel economy.**

This section describes procedures for measuring carbon monoxide (CO) and nonmethane hydrocarbon (NMHC) emissions and determining fuel economy on a cold day using the FTP test cycle (see § 1066.801).

\* \* \* \* \*

- (b) \* \* \*

(1) *Ambient temperature for emission tests.* Measure and record ambient temperature in the test cell at least once every 60 seconds during the sampling period. The temperature must be (–7.0 ±1.7)°C at the start of the test and average temperature must be (–7.0 ±2.8)°C during the test. Instantaneous temperature values may be above –4.0°C or below –9.0°C, but not for more than 3 minutes at a time during the test. At no time may the ambient temperatures be below –12.0°C or above –1.0°C.

\* \* \* \* \*

(f) The following figure illustrates the cold temperature testing sequence for measuring CO and NMHC emissions and determining fuel economy:

**Figure 1 to paragraph (f) § 1066.710—Cold Temperature Testing Sequence for Measuring CO and NMHC Emissions and Determining Fuel Economy**

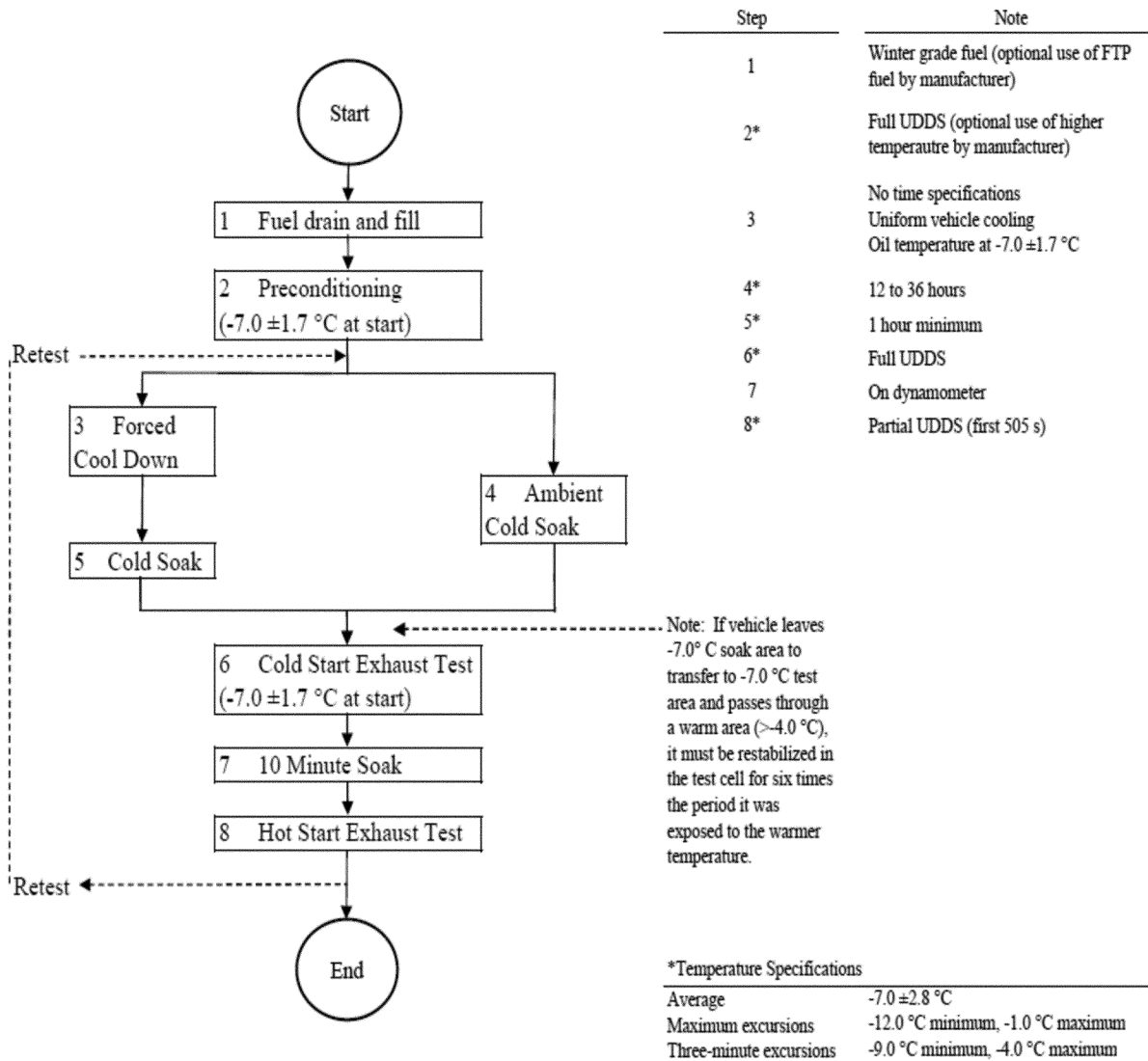

■ 276. Amend § 1066.815 by revising paragraph (d)(1)(ii) to read as follows:

**§ 1066.815 Exhaust emission test procedures for FTP testing.**

\* \* \* \* \*

- (d) \* \* \*
- (1) \* \* \*

(ii) Simultaneously start any electronic integrating devices, continuous data recording, and batch sampling before attempting to start the engine. Initiate the sequence of points in the test cycle when the engine starts. Place the vehicle in gear 15 seconds after engine starting, which is 5 seconds before the first acceleration.

\* \* \* \* \*

■ 277. Amend § 1066.831 by revising paragraph (d) to read as follows:

**§ 1066.831 Exhaust emission test procedures for aggressive driving.**

\* \* \* \* \*

(d) For diesel-fueled vehicles, measure THC emissions on a

continuous basis. For separate measurement of the city and highway test intervals as described in paragraph (c) of this section, perform separate calculations for each portion of the test cycle.

\* \* \* \* \*

■ 278. Amend § 1066.835 by revising paragraphs (f)(1), (2), and (f)(3)(iii) to read as follows:

**§ 1066.835 Exhaust emission test procedure for SC03 emissions.**

\* \* \* \* \*

- (f) \* \* \*

(1) *Ambient temperature and humidity.* Measure and record ambient temperature and humidity in the test cell at least once every 30 seconds during the sampling period. Alternatively, if you collect data of at least once every 12 seconds, you may use a moving average of up to 30 second intervals to measure and record ambient temperature and humidity. Control

ambient temperature throughout the test sequence to  $(35.0 \pm 3.0)^\circ\text{C}$ . Control ambient temperature during emission sampling to  $(33.6 \text{ to } 36.4)^\circ\text{C}$  on average. Control ambient humidity during emission sampling as described in § 1066.420(d).

(2) *Conditions before testing.* Use good engineering judgment to demonstrate that you meet the specified temperature and humidity tolerances in paragraph (f)(1) of this section during the preconditioning cycle and during the vehicle soak period in paragraph (c)(6) of this section.

- (3) \* \* \*

(iii) Determine radiant energy intensity experienced by the vehicle as the average value between two measurements along the vehicle's centerline, one at the base of the windshield and the other at the bottom of the rear window (or equivalent location for vehicles without a rear window). This value must be  $(850 \pm 45)$

W/m<sup>2</sup>. Instruments for measuring radiant energy intensity must meet the following minimum specifications:

\* \* \* \* \*

■ 279. Amend § 1066.845 by revising paragraphs (c), (f)(3) and (g) and adding paragraph (h) to read as follows:

**§ 1066.845 AC17 air conditioning efficiency test procedure.**

\* \* \* \* \*

(c) *Ambient conditions.* Measure and control ambient conditions as specified in § 1066.835(f), except that you must control ambient temperature during emission sampling to (22.0 to 28.0)°C throughout the test and (23.5 to 26.5)°C on average. These tolerances apply to the combined SC03 and HFET drive cycles during emission sampling. Note that you must set the same ambient

temperature target for both the air conditioning on and off portions of emission sampling. Control ambient temperature during the preconditioning cycle and 30 minute soak to (25.0 ± 5.0)°C. For these same modes with no emission sampling, target the specified ambient humidity levels, but you do not need to meet the humidity tolerances. Note that solar heating is disabled for certain test intervals as described in this section.

\* \* \* \* \*

(f) \* \* \*

(3) Turn on solar heating within one minute after turning off the engine. Once the solar energy intensity reaches 805 W/m<sup>2</sup>, let the vehicle soak for (30 ± 1) minutes. You may alternatively rely on prior measurements to start the soak

period after a defined period of warming up to the specified solar heat load. Close the vehicle's windows at the start of the soak period; ensure that the windows are adequately closed where instrumentation and wiring pass through to the interior.

\* \* \* \* \*

(g) *Calculations.* (1) Determine the mass of CO<sub>2</sub> emissions for each of the two test intervals as described in § 1066.605.

(2) Calculate separate composite mass-weighted emissions of CO<sub>2</sub>,  $e_{CO_2-AC17compAC[status]}$ , representing the average of the SC03 and HFET emissions, in grams per mile for operation with the vehicle's air conditioner and the solar heating on and off using the following equation:

$$e_{CO_2-AC17compAC[status]} = 0.5 \cdot \left( \frac{m_{SC03}}{D_{SC03}} \right) + 0.5 \cdot \left( \frac{m_{HFET}}{D_{HFET}} \right)$$

Eq. 1066.845-1

Where:

- $m_{SC03}$  = mass emissions from the SC03 test interval, in grams.
- $D_{SC03}$  = measured driving distance during the SC03 test interval, in miles.
- $m_{HFET}$  = mass emissions from the HFET test interval, in grams.
- $D_{HFET}$  = measured driving distance during the HFET test interval, in miles.

(3) Calculate the incremental CO<sub>2</sub> emissions due to air conditioning operation by subtracting the composite mass-weighted emissions of CO<sub>2</sub> with the vehicle's air conditioner and the solar heating on,  $e_{CO_2-AC17compACon}$ , from the composite mass-weighted emissions of CO<sub>2</sub> with the vehicle's air conditioner and the solar heating off,

$e_{CO_2-AC17compACoff}$ .

(h) Record information for each test as specified in § 1066.695. Emission results and the results of all calculations must be reported for each phase of the test. The manufacturer must also report the following information for each vehicle tested: interior volume, climate control system type and characteristics, refrigerant used, compressor type, and evaporator/condenser characteristics.

■ 280. Amend § 1066.1001 by adding definitions of "Charge-depleting" and "Charge-sustaining" in alphabetical order and revising the definition of "Test interval" to read as follows:

**§ 1066.1001 Definitions.**

\* \* \* \* \*

*Charge-depleting* means relating to the test interval of a plug-in hybrid engine or powertrain in which the engine or powertrain consumes electric energy from the RESS that has been charged from an external power source until the RESS is depleted to the point that a test interval qualifies as charge-sustaining. The engine might consume fuel to produce power during a charge-depleting test interval.

*Charge-sustaining* means relating to the test interval of a plug-in hybrid engine or powertrain in which the engine or powertrain consumes fuel to produce power such that the battery's net-energy change meets the end-of-test criterion of SAE J1711 or SAE J2711, as applicable (incorporated by reference in § 1066.1010).

\* \* \* \* \*

*Test interval* means a period over which a vehicle's emission rates are determined separately. For many standards, compliance with the standard is based on a weighted average of the mass emissions from multiple test intervals. For example, the standard-setting part may specify a complete duty cycle as a cold-start test interval and a hot-start test interval. In cases where multiple test intervals occur over a duty cycle, the standard-setting part may specify additional calculations that weight and combine results to arrive at composite values for comparison against the applicable standards in this chapter.

\* \* \* \* \*

■ 281. Amend § 1066.1005 by revising paragraphs (b), (g), and (h) to read as follows:

**§ 1066.1005 Symbols, abbreviations, acronyms, and units of measure.**

\* \* \* \* \*

(b) *Symbols for chemical species.* This part uses the following symbols for chemical species and exhaust constituents:

TABLE 2 TO PARAGRAPH (b) OF § 1066.1005—SYMBOLS FOR CHEMICAL SPECIES AND EXHAUST CONSTITUENTS

Symbol	Species
CH <sub>4</sub> .....	methane.
CH <sub>3</sub> OH .....	methanol.
CH <sub>2</sub> O .....	formaldehyde.
C <sub>2</sub> H <sub>4</sub> O .....	acetaldehyde.
C <sub>2</sub> H <sub>5</sub> OH .....	ethanol.
C <sub>2</sub> H <sub>6</sub> .....	ethane.
C <sub>3</sub> H <sub>7</sub> OH .....	propanol.

TABLE 2 TO PARAGRAPH (b) OF § 1066.1005—SYMBOLS FOR CHEMICAL SPECIES AND EXHAUST CONSTITUENTS—Continued

Symbol	Species
C <sub>3</sub> H <sub>8</sub> .....	propane.
C <sub>4</sub> H <sub>10</sub> .....	butane.
C <sub>5</sub> H <sub>12</sub> .....	pentane.
CO .....	carbon monoxide.
CO <sub>2</sub> .....	carbon dioxide.
H <sub>2</sub> O .....	water.
HC .....	hydrocarbon.
N <sub>2</sub> .....	molecular nitrogen.
NMHC .....	nonmethane hydrocarbon.
NMHCE .....	nonmethane hydrocarbon equivalent.
NMOG .....	nonmethane organic gas.
NO .....	nitric oxide.
NO <sub>2</sub> .....	nitrogen dioxide.
NO <sub>x</sub> .....	oxides of nitrogen.
N <sub>2</sub> O .....	nitrous oxide.
O <sub>2</sub> .....	molecular oxygen.
OHC .....	oxygenated hydrocarbon.
PM .....	particulate matter.
THC .....	total hydrocarbon.
THCE .....	total hydrocarbon equivalent.

\* \* \* \* \*

(g) *Constants.* (1) This part uses the following constants for the composition of dry air:

TABLE 7 TO PARAGRAPH (g)(1) OF § 1066.1005—CONSTANTS FOR THE COMPOSITION OF DRY AIR

Symbol	Quantity	mol/mol
X <sub>Ar</sub> air .....	amount of argon in dry air.	0.00934
X <sub>CO2</sub> air .....	amount of carbon dioxide in dry air.	0.000375
X <sub>N2</sub> air .....	amount of nitrogen in dry air.	0.78084
X <sub>O2</sub> air .....	amount of oxygen in dry air.	0.209445

(2) This part uses the following molar masses or effective molar masses of chemical species:

TABLE 8 TO PARAGRAPH (g)(2) OF § 1066.1005—MOLAR MASSES OR EFFECTIVE MOLAR MASSES OF CHEMICAL SPECIES

Symbol	Quantity	g/mol (10 <sup>-3</sup> .kg.mol <sup>-1</sup> )
M <sub>air</sub> .....	molar mass of dry air <sup>1</sup> .	28.96559

TABLE 8 TO PARAGRAPH (g)(2) OF § 1066.1005—MOLAR MASSES OR EFFECTIVE MOLAR MASSES OF CHEMICAL SPECIES—Continued

Symbol	Quantity	g/mol (10 <sup>-3</sup> .kg.mol <sup>-1</sup> )
M <sub>H2O</sub> .....	molar mass of water.	18.01528

<sup>1</sup> See paragraph (g)(1) of this section for the composition of dry air.

(3) This part uses the following molar gas constant for ideal gases:

TABLE 9 TO PARAGRAPH (g)(3) OF § 1066.1005—MOLAR GAS CONSTANT FOR IDEAL GASES

Symbol	Quantity	J/(mol·K) (m <sup>2</sup> .kg.s <sup>-2</sup> .mol <sup>-1</sup> .K <sup>-1</sup> )
R .....	molar gas constant	8.314472

(h) *Prefixes.* This part uses the following prefixes to define a quantity:

TABLE 10 TO PARAGRAPH (h) OF § 1066.1005—PREFIXES TO DEFINE A QUANTITY

Symbol	Quantity	Value
n .....	nano .....	10 <sup>-9</sup>
μ .....	micro .....	10 <sup>-6</sup>
m .....	milli .....	10 <sup>-3</sup>
c .....	centi .....	10 <sup>-2</sup>
k .....	kilo .....	10 <sup>3</sup>
M .....	mega .....	10 <sup>6</sup>

■ 282. Revise § 1066.1010 to read as follows:

**§ 1066.1010 Incorporation by reference.**

Certain material is incorporated by reference into this part with the approval of the Director of the Federal Register under 5 U.S.C. 552(a) and 1 CFR part 51. To enforce any edition other than that specified in this section, EPA must publish a document in the **Federal Register** and the material must be available to the public. All approved incorporation by reference (IBR) material is available for inspection at

EPA and at the National Archives and Records Administration (NARA). Contact EPA at: U.S. EPA, Air and Radiation Docket Center, WJC West Building, Room 3334, 1301 Constitution Ave. NW, Washington, DC 20004; [www.epa.gov/dockets](http://www.epa.gov/dockets); (202) 202-1744. For information on inspecting this material at NARA, visit [www.archives.gov/federal-register/cfr/ibr-locations.html](http://www.archives.gov/federal-register/cfr/ibr-locations.html) or email [fr.inspection@nara.gov](mailto:fr.inspection@nara.gov). The material may be obtained from the following sources:



(a) National Institute of Standards and Technology (NIST), 100 Bureau Drive, Stop 1070, Gaithersburg, MD 20899–1070; (301) 975–6478; [www.nist.gov](http://www.nist.gov).

(1) NIST Special Publication 811, 2008 Edition, Guide for the Use of the International System of Units (SI), Physics Laboratory, March 2008; IBR approved for §§ 1066.20(a); 1066.1005.

(2) [Reserved]

(b) SAE International, 400 Commonwealth Dr., Warrendale, PA 15096–0001; (877) 606–7323 (U.S. and Canada) or (724) 776–4970 (outside the U.S. and Canada); [www.sae.org](http://www.sae.org).

(1) SAE J1263 MAR2010, Road Load Measurement and Dynamometer Simulation Using Coastdown Techniques, Revised March 2010, (“SAE J1263”); IBR approved for §§ 1066.301(b); 1066.305(a); 1066.310(b).

(2) SAE J1634 JUL2017, Battery Electric Vehicle Energy Consumption and Range Test Procedure, Revised July 2017, (“SAE J1634”); IBR approved for § 1066.501(a).

(3) SAE J1711 JUN2010, Recommended Practice for Measuring the Exhaust Emissions and Fuel Economy of Hybrid-Electric Vehicles, Including Plug-In Hybrid Vehicles, Revised June 2010, (“SAE J1711”); IBR approved for §§ 1066.501(a); 1066.1001.

(4) SAE J2263 DEC2008, Road Load Measurement Using Onboard Anemometry and Coastdown Techniques, Revised December 2008; IBR approved for §§ 1066.301(b); 1066.305; 1066.310(b).

(5) SAE J2263 MAY2020, (R) Road Load Measurement Using Onboard Anemometry and Coastdown Techniques, Revised May 2020, (“SAE J2263”); IBR approved for §§ 1066.301(b); 1066.305; 1066.310(b).

(6) SAE J2264 JAN2014, Chassis Dynamometer Simulation of Road Load Using Coastdown Techniques, Revised January 2014, (“SAE J2264”); IBR approved for § 1066.315.

(7) SAE J2711 MAY2020, (R) Recommended Practice for Measuring Fuel Economy and Emissions of Hybrid-Electric and Conventional Heavy-Duty Vehicles, Revised May 2020, (“SAE J2711”); IBR approved for §§ 1066.501(a); 1066.1001.

(8) SAE J2951 JAN2014, Drive Quality Evaluation for Chassis Dynamometer Testing, Revised January 2014, (“SAE J2951”); IBR approved for § 1066.425(j).

**PART 1068—GENERAL COMPLIANCE PROVISIONS FOR HIGHWAY, STATIONARY, AND NONROAD PROGRAMS**

■ 283. The authority citation for part 1068 continues to read as follows:

Authority: 42 U.S.C. 7401–7671q.

■ 284. Amend § 1068.1 by revising paragraphs (a)(2), (4), (5), (6), (8), (9), and (13) and adding paragraph (a)(15) to read as follows:

**§ 1068.1 Does this part apply to me?**

(a) \* \* \*

(2) This part 1068 applies for heavy-duty motor vehicles and motor vehicle engines we regulate under 40 CFR parts 1036 and 1037. This includes trailers. This part 1068 applies to heavy-duty motor vehicles and motor vehicle engines certified under 40 CFR part 86 to the extent and in the manner specified in 40 CFR parts 85, 86, and 1036.

\* \* \* \* \*

(4) This part applies to aircraft and aircraft engines we regulate under 40 CFR parts 1030 and 1031 to the extent and in the manner specified in 40 CFR parts 1030 and 1031.

(5) This part 1068 applies for locomotives that are subject to the provisions of 40 CFR part 1033.

(6) This part 1068 applies for land-based nonroad compression-ignition engines that are subject to the provisions of 40 CFR part 1039. This part 1068 applies for engines certified under 40 CFR part 89 to the extent and in the manner specified in 40 CFR part 1039.

\* \* \* \* \*

(8) This part 1068 applies for marine compression-ignition engines that are subject to the provisions of 40 CFR part 1042. This part 1068 applies for marine compression-ignition engines certified under 40 CFR part 94 to the extent and in the manner specified in 40 CFR part 1042.

(9) This part 1068 applies for marine spark-ignition engines that are subject to the provisions of 40 CFR part 1045. This part 1068 applies for marine spark-ignition engines certified under 40 CFR part 91 to the extent and in the manner specified in 40 CFR part 1045.

\* \* \* \* \*

(13) This part applies for small nonroad spark-ignition engines that are subject to the provisions of 40 CFR part 1054. This part 1068 applies for nonroad spark-ignition engines certified under 40 CFR part 90 to the extent and in the manner specified in 40 CFR part 1054.

\* \* \* \* \*

(15) This part 1068 applies to portable fuel containers we regulate under 40 CFR part 59 to the extent and in the manner specified in 40 CFR part 59, subpart F.

\* \* \* \* \*

■ 285. Revise § 1068.10 to read as follows:

**§ 1068.10 Practices for handling confidential business information.**

The provisions of this section apply both to any information you send us and to any information we collect from inspections, audits, or other site visits.

(a) When you submit information to us, if you claim any of that information as confidential, you may identify what you claim to be confidential by marking, circling, bracketing, stamping, or some other method; however, we will not consider any claims of confidentiality over information we have determined to be not entitled to confidential treatment under § 1068.11 or other applicable provisions.

(b) If you send us information without claiming it is confidential, we may make it available to the public without further notice to you, as described in 40 CFR 2.301(j).

(c) For submissions that include information that may be entitled to confidential treatment, we may require that you send a “public” copy of the report that does not include the confidential information. We may require that you substantiate your claim to confidential treatment for any items not contained in the public version. We will release additional information from the complete version of such a submission only as allowed under 40 CFR 2.301(j) and as described in this subpart and the standard-setting part.

(d) We will safeguard your confidential business information (CBI) as described in 40 CFR 2.301(j). Also, we will treat certain information as confidential and will only disclose this information if it has been determined to be not entitled to confidential treatment as specified in § 1068.11(c). The following general provisions describe how we will process requests for making information publicly available:

(1) *Certification information.* We will treat information submitted in an application for certification as confidential until the introduction-into-commerce date you identify in your application for certification consistent with 40 CFR 2.301(a)(2)(ii)(B). If you do not identify an introduction-into-commerce date or if we issue the certificate after your specified date, we will treat information submitted in an application for certification as described in § 1068.11 after the date we issue the certificate.

(2) *Preliminary and superseded information.* Preliminary and superseded versions of information you submit are covered by confidentiality determinations in the same manner as

final documents. However, we will generally not disclose preliminary or superseded information unless we receive a request under 5 U.S.C. 552 that specifically asks for all versions of a document, including preliminary and superseded versions. We will consider a document preliminary if we have not reviewed it to verify its accuracy or if the reporting deadline has not yet passed. We will consider information superseded if you submit a new document or a revised application for certification to replace the earlier version.

(3) *Authorizing CBI disclosure.* The provisions of this section do not prevent us from disclosing protected information if you specifically authorize it.

(4) *Relationship to the standard-setting part.* The standard-setting part may identify additional provisions related to confidentiality determinations. Note that the standard-setting part identifies information requirements that apply for each type of engine/equipment. If this section identifies information that is not required for a given engine, that does not create a requirement to submit the information.

(5) *Changes in law.* The confidentiality determinations in this section and in the standard-setting parts may be changed through the processes described in 40 CFR 2.301(j)(4).

■ 286. Add § 1068.11 to subpart A to read as follows:

**§ 1068.11 Confidentiality determinations and related procedures.**

This section characterizes various categories of information for purposes of making confidentiality determinations, as follows:

(a) This paragraph (a) applies the definition of “Emission data” in 40 CFR 2.301(a) for information related to engines/equipment subject to this part. “Emission data” cannot be treated as confidential business information and shall be available to be disclosed to the public except as specified in § 1068.10(d)(1). The following categories of information qualify as emission data, except as specified in paragraph (c) of this section:

(1) Certification and compliance information, including information submitted in an application for a certificate of conformity that is used to assess compliance.

(2) Fleet value information, including information submitted for compliance with fleet average emission standards and emissions related ABT credit information, including the information used to generate credits.

(3) Source family information. For example, engine family information or test group information would identify the regulated emission source.

(4) Test information and results, including emission test results and other data from emission testing that are submitted in an application for a certificate of conformity, test results from in-use testing, production-line testing, and any other testing to demonstrate emissions. The information in this category includes all related information to characterize test results, document the measurement procedure, and modeling inputs and outputs where the compliance demonstration is based on computer modeling.

(5) ABT credit information, including information submitted for current and future compliance demonstrations using credits under an ABT program.

(6) Production volume, including information submitted for compliance with fleet average emission standards, compliance with requirements to test production engines/equipment, or compliance through ABT programs.

(7) Defect and recall information, including all information submitted in relation to a defect or recall except the remedial steps you identify in § 1068.510(a)(2).

(8) Selective enforcement audit compliance information.

(b) The following categories of information are not eligible for confidential treatment, except as specified in § 1068.10(d)(1):

(1) Published information, including information that is made available in annual and quarterly filings submitted to the U.S. Securities and Exchanges Commission, on company websites, or otherwise made publicly available by the information submitter.

(2) Observable information available to the public after the introduction to commerce date.

(c) The following categories of information are subject to the process for confidentiality determinations in 40 CFR part 2 as described in 40 CFR 2.301(j)(5):

(1) Projected sales volume and projected production volume.

(2) Production start and end dates.

(3) Detailed description of emission control operation and function.

(4) Design specifications related to aftertreatment devices.

(5) Description of auxiliary emission control devices (AECDS).

(6) Plans for meeting regulatory requirements. For example, this applies for any projections of emission credits for the coming model year or determinations of the number of

required repair facilities that are based on projected production volumes.

(7) The following information related to deterioration factors and other adjustment factors:

(i) Procedures to determine deterioration factors and other emission adjustment factors.

(ii) Any information used to justify those procedures.

(iii) Emission measurements you use to compare procedures or demonstrate that the procedures are appropriate.

(8) Financial information related to the following items:

(i) ABT credit transactions, including dollar amount, identity of parties, and contract information.

(ii) Meeting bond requirements, including aggregate U.S. asset holdings, financial details regarding specific assets, whether the manufacturer or importer obtains a bond, and copies of bond policies.

(9) Serial numbers or other information to identify specific engines or equipment selected for testing.

(10) Procedures that apply based on your request to test engines/equipment differently than we specify in the regulation. This applies for special and alternative test procedures. This also applies, for example, if we approve a broader or narrower zone of engine operation for not-to-exceed testing.

(11) Information related to testing vanadium catalysts in 40 CFR part 1065, subpart L.

(12) GPS data identifying the location for in-use emission measurements.

(13) Information related to possible defects that are subject to further investigation (not confirmed defects).

(14) Information submitted in support of a requested exemption.

(d) If you submit information that is not addressed in paragraphs (a) through (c) of this section, you may claim the information as confidential. We may require you to provide us with information to substantiate your claims. If claimed, we may consider this substantiating information to be confidential to the same degree as the information for which you are requesting confidential treatment. We will make our determination based on your statements to us, the supporting information you send us, and any other available information. However, we may determine that your information is not subject to confidential treatment consistent with 40 CFR part 2 and 5 U.S.C. 552(b)(4).

(e) Applications for certification and submitted reports typically rely on software or templates to identify specific categories of information. If you submit information in a comment field

designated for users to add general information, we will respond to requests for disclosing that information consistent with paragraphs (a) through (d) of this section.

■ 287. Amend § 1068.30 by adding a definition of “Critical emission-related component” in alphabetical order and revising the definition of “Designated Compliance Officer” to read as follows:

**§ 1068.30 Definitions.**

\* \* \* \* \*

*Critical emission-related component* means a part or system whose primary purpose is to reduce emissions or whose failure would commonly increase emissions without significantly degrading engine/equipment performance.

\* \* \* \* \*

*Designated Compliance Officer* means one of the following:

(1) For motor vehicles regulated under 40 CFR part 86, subpart S: Director, Light-Duty Vehicle Center, U.S. Environmental Protection Agency, 2000 Traverwood Drive, Ann Arbor, MI 48105; [complianceinfo@epa.gov](mailto:complianceinfo@epa.gov); [www.epa.gov/ve-certification](http://www.epa.gov/ve-certification).

(2) For compression-ignition engines used in heavy-duty highway vehicles regulated under 40 CFR part 86, subpart A, and 40 CFR parts 1036 and 1037, and for nonroad and stationary compression-ignition engines or equipment regulated under 40 CFR parts 60, 1033, 1039, and 1042: Director, Diesel Engine Compliance Center, U.S. Environmental Protection Agency, 2000 Traverwood Drive, Ann Arbor, MI 48105; [complianceinfo@epa.gov](mailto:complianceinfo@epa.gov); [www.epa.gov/ve-certification](http://www.epa.gov/ve-certification).

(3) Director, Gasoline Engine Compliance Center, U.S. Environmental Protection Agency, 2000 Traverwood Drive, Ann Arbor, MI 48105; [complianceinfo@epa.gov](mailto:complianceinfo@epa.gov); [www.epa.gov/ve-certification](http://www.epa.gov/ve-certification), for all the following engines and vehicles:

(i) For spark-ignition engines used in heavy-duty highway vehicles regulated under 40 CFR part 86, subpart A, and 40 CFR parts 1036 and 1037.

(ii) For highway motorcycles regulated under 40 CFR part 86, subpart E.

(iii) For nonroad and stationary spark-ignition engines or equipment regulated under 40 CFR parts 60, 1045, 1048, 1051, 1054, and 1060.

■ 288. Add § 1068.50 to subpart A to read as follows:

**§ 1068.50 Adjustable parameters.**

(a) The standard-setting part requires as a condition of certification that engines with adjustable parameters meet

all the requirements of the standard-setting part for any setting in the practically adjustable range. This section defines these terms and describes general provisions that apply broadly across sectors. This section refers to engines, because most adjustable parameters are integral to the engine even in the case of equipment-based standards; this section also applies for equipment-based adjustable parameters. The provisions of this section apply starting with model year 2027 and are optional for earlier model years.

(b) You must use good engineering judgment for all decisions related to adjustable parameters. We recommend that you ask for preliminary approval for decisions related to new technologies, substantially changed engine designs, or new methods for limiting adjustability. The standard-setting part describes the information you must include in the application for certification related to adjustable parameters. Decisions related to adjustable parameters include the following:

(1) Determining which engine operating parameters qualify as adjustable parameters.

(2) Establishing the adequacy of the limits, stops, seals, programming limits, inducements, or other means used to limit adjustment, limit reprogramming, or ensure replenishment.

(3) Defining the practically adjustable range for each such parameter.

(c) For purposes of this section, “operating parameter” means any feature that can, by the nature of its design, be adjusted to affect engine performance. For example, while bolts used to assemble the engine are practically adjustable (can be loosened or tightened), they are not adjustable parameters because they are not operating parameters. Consider all programmable parameters not involving user-selectable controls to be a single, collective operating parameter.

(d) Operating parameters are considered adjustable parameters if they are practically adjustable by a user or other person by physical adjustment, programmable adjustment, or regular replenishment of a fluid or other consumable material. However, an operating parameter is not an adjustable parameter if—

(1) We determine it is permanently sealed or it is not practically adjustable using available tools, as described in paragraph (e) of this section; or

(2) We determine that engine operation over the full range of adjustment does not affect emissions without also degrading engine

performance to the extent that operators will be aware of the problem.

(e) An operating parameter is considered practically adjustable as follows:

(1) Physically adjustable parameters are considered practically adjustable if the adjustment is accessible and can be performed by an experienced mechanic using appropriate tools within the following time and cost thresholds, excluding extraordinary measures:

(i) For engines at or below 30 kW, physically adjustable parameters are considered practically adjustable if a typical user can make adjustments with ordinary tools within 15 minutes using service parts that cost no more than \$30.

(ii) For 30–560 kW engines, physically adjustable parameters are considered practically adjustable if a qualified mechanic can make adjustments with ordinary tools within 60 minutes using service parts that cost no more than \$60.

(iii) For engines above 560 kW, physically adjustable parameters are considered practically adjustable if a qualified mechanic can make adjustments with any available supplies and tools within 60 minutes.

(iv) Cost thresholds in this section are expressed in 2020 dollars. Adjust these values for certification by comparing most recently available Consumer Price Index for All Urban Consumers (CPI-U) value published by the Bureau of Labor Statistics at [www.bls.gov/data/inflation\\_calculator.htm](http://www.bls.gov/data/inflation_calculator.htm).

(v) Cost thresholds do not include the cost of labor or the cost of any necessary tools or nonconsumable supplies. Time thresholds refer to the time required to access and adjust the parameter, excluding any time necessary to purchase parts, tools, or supplies, or to perform testing.

(vi) The term “ordinary tools” has the following meanings for different sizes of engines:

(A) Ordinary tools consist of slotted and Phillips head screwdrivers, pliers, hammers, awls, wrenches, electric screwdrivers, electric drills, and any tools supplied by the manufacturer, where those tools are used for their intended purpose.

(B) For 30–560 kW engines, ordinary tools includes the tools identified in paragraph (e)(1)(vi)(A) of this section and any other hand tools, solvents, or other supplies sold at hardware stores, automotive parts supply stores or on the internet.

(vii) The following extraordinary measures are not included when determining whether a physically adjustable parameter is considered

“practically adjustable” according to the specified time and cost thresholds:

(A) Removing the cylinder head(s) from the engine block.

(B) Fully or partially removing a carburetor.

(C) Drilling or grinding through caps or plugs.

(D) Causing damage to engine or equipment if the associated repair would exceed the time or cost thresholds in this paragraph (e)(1).

(E) Making special tools to override design features that prevent adjustment. Note that extraordinary measures do not include purchase of such special tools if they become available as described in paragraph (e)(1)(vi)(B) of this section.

(2) A programmable operating parameter is considered “practically adjustable” if an experienced mechanic can adjust the parameter using any available tools (including devices that are used to alter computer code). Conversely, such parameters are not practically adjustable if you limit access to electronic control modules with password or encryption protection. You must have adequate protections in place to prevent distribution and use of passwords or encryption keys. This paragraph (e)(2) applies for engines with any degree of programmable control. Programmable settings are considered practically adjustable if any of the following apply:

(i) The user can make the adjustment by following instructions in the owners manual.

(ii) An experienced mechanic can make the adjustment using ordinary digital interface tools for selecting available settings or options as described in this paragraph (e)(2).

(f) The practically adjustable range for physically adjustable operating parameters is based on design features to create physical limits or stops to limit adjustment. A physical limit or stop is adequate for defining the limits of the practically adjustable range if it has the following characteristics:

(1) In the case of a threaded adjustment, the head is sheared off after adjustment at the factory or the threads are terminated, pinned, or crimped to prevent additional travel without causing damage for which the repair would exceed the time or cost thresholds in paragraph (e)(1) of this section.

(2) In the case of fasteners, bimetal springs, or other mechanical devices used to limit adjustment, those devices are recessed within a larger, permanent body and sealed with a plug, cap, or cover plate that limits access to the device consistent with the time and cost

thresholds in paragraph (e)(1) of this section.

(3) Operators cannot exceed the travel or rotation limits using appropriate tools without causing damage for which the repairs would exceed the time or cost thresholds specified in paragraph (e)(1) of this section. For example, if a vehicle has a shim, bushing, or other device to limit flow rates, range of travel, or other parameters to prevent operating outside of a specified range of engine or vehicle speeds, you must take steps to prevent operators or mechanics from removing, replacing, or altering those parts to operate at a wider range of engine or vehicle speeds.

(g) Apply the following provisions to determine the practically adjustable range for programmable parameters that can be adjusted by changing software or operating parameters (“reflashed”):

(1) If an engine includes multiple operating modes or other algorithms that can be selected or are easily accessible, consider each of the selectable or accessible modes or settings to be within the practically adjustable range.

(2) If you sell or offer to sell software or other tools that an experienced mechanic not affiliated with the manufacturer could use to reflash or otherwise modify the electronic control module, consider all those settings to be within the practically adjustable range.

(3) The following systems and features illustrate examples of the types of programmable settings for which this paragraph (g) applies:

(i) Air-fuel setpoints for closed-loop fuel systems.

(ii) Reductant flow systems.

(iii) Base maps for fuel injection or spark timing.

(iv) Exhaust gas recirculation maps.

(h) The following provisions apply for adjustable parameters related to elements of design involving consumption and replenishment, such as DEF tank fill level and hybrid battery state of charge:

(1) We will determine the range of adjustability based on the likelihood of in-use operation at a given point in the physically adjustable range. We may determine that operation in certain subranges within the physically adjustable range is sufficiently unlikely that the subranges should be excluded from the allowable adjustable range for testing. In such cases, the engines/equipment are not required to meet the emission standards for operation in an excluded subrange.

(2) Shipping new engines/equipment in a state or configuration requiring replenishment to be within the range of adjustability for a certified configuration

does not cause a violation of the prohibition in § 1068.101(a)(1).

(i) We will make determinations regarding in-use adjustments of adjustable parameters under this section for certifying engines as follows:

(1) Our determinations will depend on in-use maintenance practices conforming to the maintenance and service information you provide. For example, if your published maintenance instructions describe routine procedures for adjusting engines or if you or your dealers make specialized tools available to operators, we will conclude that such adjustments are likely to occur. Also, your maintenance and service information may not specify adjustable ranges that are broader than those that you specify in your application for certification.

(2) We may review manufacturer statements under this section for certifying engines for a later model year if we learn from observation of in-use engines or other information that a parameter was in fact practically adjustable or that the specified operating range was in fact not correct. We may require you to include a new adjustable parameter or to revise your specified operating range for an adjustable parameter.

(j) We may inspect your engines at any time to determine whether they meet the specifications of this section. We may purchase engines for testing, or we may ask you to supply engines for such inspections. We will inspect using appropriate tools and time limits and using any available devices that alter computer code, as specified in paragraph (e)(2) of this section. The inspection will determine the following:

(1) If the adjustable parameter is limited to the adjustable range specified in the manufacturer’s certification application.

(2) If physical stops for physically adjustable parameters can be bypassed using methods outlined in paragraph (f) of this section.

(k) Except as provided in the standard-setting part and this paragraph (k), engines are not in the certified configuration if you produce them with adjustable parameters set outside the range specified in your application for certification. Similarly, engines are not in the certified configuration if you produce them with other operating parameters that do not conform to the certified configuration. Where we determine that you failed to identify something that should be considered an adjustable parameter, we may require you to treat the parameter as defective under § 1068.501. If we determine you deliberately misrepresented the

accessibility of the parameter or that you did not act in good faith, we may take action regarding your certificate as described in the standard-setting part (see, for example, 40 CFR 1054.255).

(l) Nothing in this section limits the tampering prohibition of § 1068.101(b)(1) or the defeat device prohibition of § 1068.101(b)(2).

■ 289. Amend § 1068.101 by revising paragraphs (a) introductory text and (b)(5) to read as follows:

**§ 1068.101 What general actions does this regulation prohibit?**

\* \* \* \* \*

(a) The following prohibitions and requirements apply to manufacturers of new engines, manufacturers of equipment containing these engines, manufacturers of new equipment, and other persons as provided by § 1068.1(a), except as described in subparts C and D of this part:

\* \* \* \* \*

(b) \* \* \*

(5) *Importation.* You may not import an uncertified engine or piece of equipment if it is defined to be new in the standard-setting part with a model year for which emission standards applied. Anyone violating this paragraph (b)(5) is deemed to be a manufacturer in violation of paragraph (a)(1) of this section. We may assess a civil penalty up to \$44,539 for each engine or piece of equipment in violation. Note the following:

\* \* \* \* \*

■ 290. Amend § 1068.210 by revising paragraph (c) introductory text to read as follows:

**§ 1068.210 Exempting test engines/equipment.**

\* \* \* \* \*

(c) If you are a certificate holder, you may request an exemption for engines/equipment you intend to include in a test program.

\* \* \* \* \*

■ 291. Amend § 1068.220 by revising paragraph (b) to read as follows:

**§ 1068.220 Exempting display engines/equipment.**

\* \* \* \* \*

(b) Nonconforming display engines/equipment will be exempted if they are used for displays in the interest of a business or the general public. The exemption in this section does not apply to engines/equipment displayed for any purpose we determine is inappropriate for a display exemption.

\* \* \* \* \*

■ 292. Amend § 1068.240 by revising paragraphs (a)(1), (b)(3), and (c)(3)(ii) to read as follows:

**§ 1068.240 Exempting new replacement engines.**

\* \* \* \* \*

(a) \* \* \*

(1) Paragraphs (b) and (c) of this section describe different approaches for exempting new replacement engines where the engines are specially built to correspond to an engine model from an earlier model year that was subject to less stringent standards than those that apply for current production (or is no longer covered by a certificate of conformity). You must comply with the requirements of paragraph (b) of this section for any number of replacement engines you produce in excess of what we allow under paragraph (c) of this section. You must designate engines you produce under this section as tracked engines under paragraph (b) of this section or untracked engines under paragraph (c) of this section by the deadline for the report specified in paragraph (c)(3) of this section.

\* \* \* \* \*

(b) \* \* \*

(3) An old engine block replaced by a new engine exempted under this paragraph (b) may be reintroduced into U.S. commerce as part of an engine that meets either the current standards for new engines, the provisions for new replacement engines in this section, or another valid exemption. Otherwise, you must destroy the old engine block (or confirm that it has been destroyed), or export the engine block without its emission label. Note that this paragraph (b)(3) does not require engine manufacturers to take possession of the engine being replaced. Owners may arrange to keep the old engine if they demonstrate that the engine block has been destroyed. An engine block is destroyed under this paragraph (b)(3) if it can never be restored to a running configuration.

\* \* \* \* \*

(c) \* \* \*

(3) \* \* \*

(ii) Count exempt engines as tracked under paragraph (b) of this section only if you meet all the requirements and conditions that apply under paragraph (b)(2) of this section by the due date for the annual report. In the annual report you must identify any replaced engines from the previous year whose final disposition is not resolved by the due date for the annual report. Continue to report those engines in later reports until the final disposition is resolved. If the final disposition of any replaced engine is not resolved for the fifth

annual report following the production report, treat this as an untracked replacement in the fifth annual report for the preceding year.

\* \* \* \* \*

■ 293. Amend § 1068.261 by revising paragraphs (b), (c) introductory text, and (d) introductory text to read as follows:

**§ 1068.261 Delegated assembly and other provisions related to engines not yet in the certified configuration.**

\* \* \* \* \*

(b) If you manufacture engines and install them in equipment you or an affiliated company also produce, you must take steps to ensure that your facilities, procedures, and production records are set up to ensure that equipment and engines are assembled in their proper certified configurations. For example, you may demonstrate compliance with the requirements of this section by maintaining a database showing how you pair aftertreatment components with the appropriate engines such that the final product is in its certified configuration.

(c) If you manufacture engines and ship them to an unaffiliated company for installation in equipment and you include the price of all aftertreatment components in the price of the engine (whether or not you ship the aftertreatment components directly to the equipment manufacturer), all the following conditions apply:

\* \* \* \* \*

(d) If you manufacture engines and ship them to an unaffiliated company for installation in equipment, but you do not include the price of all aftertreatment components in the price of the engine, you must meet all the conditions described in paragraphs (c)(1) through (9) of this section, with the following additional provisions:

\* \* \* \* \*

■ 294. Amend § 1068.301 by revising paragraph (b) to read as follows:

**§ 1068.301 General provisions for importing engines/equipment.**

\* \* \* \* \*

(b) In general, engines/equipment that you import must be covered by a certificate of conformity unless they were built before emission standards started to apply. This subpart describes the limited cases where we allow importation of exempt or excluded engines/equipment. If an engine has an exemption from exhaust emission standards, you may import the equipment under the same exemption. Imported engines/equipment that are exempt or excluded must have a label as described in the specific exemption

or exclusion. If the regulation does not include specific labeling requirements, apply a label meeting the requirements of § 1068.45 that identifies your corporate name and describes the basis for the exemption or exclusion.

\* \* \* \* \*

■ 295. Amend § 1068.310 by revising the introductory text and paragraph (e)(4) to read as follows:

**§ 1068.310 Exclusions for imported engines/equipment.**

If you show us that your engines/equipment qualify under one of the paragraphs of this section, we will approve your request to import such excluded engines/equipment. You must have our approval before importing engines/equipment under paragraph (a) of this section. You may, but are not required, to request our approval to import the engines/equipment under paragraph (b) through (d) of this section. Qualifying engines/equipment are excluded as follows:

\* \* \* \* \*

(e) \* \* \*

(4) State: “THIS ENGINE IS EXEMPT FROM THE REQUIREMENTS OF [identify the part referenced in § 1068.1(a) that would otherwise apply], AS PROVIDED IN [identify the paragraph authorizing the exemption (for example, “40 CFR 1068.310(a))]. INSTALLING THIS ENGINE IN ANY DIFFERENT APPLICATION MAY BE A VIOLATION OF FEDERAL LAW SUBJECT TO CIVIL PENALTY.”

■ 296. Amend § 1068.315 by revising paragraphs (a) and (h) and removing paragraph (i) to read as follows:

**§ 1068.315 Permanent exemptions for imported engines/equipment.**

\* \* \* \* \*

(a) *National security exemption.* You may import an engine or piece of equipment under the national security exemption in § 1068.225.

\* \* \* \* \*

(h) *Identical configuration exemption.* Unless specified otherwise in the standard-setting part, you may import nonconforming engines/equipment if they are identical in all material respects to certified engines/equipment produced by the same manufacturer, subject to the following provisions:

(1) You must meet all the following criteria:

(i) You have owned the engines/equipment for at least six months.

(ii) You agree not to sell, lease, donate, trade, or otherwise transfer ownership of the engines/equipment for at least five years. The only acceptable way to dispose of the engines/

equipment during this five-year period is to destroy or export them.

(iii) You use data or evidence sufficient to show that the engines/equipment are in a configuration that is identical in all material respects to engines/equipment the original manufacturer has certified to meet emission standards that apply at the time the manufacturer finished assembling or modifying the engines/equipment in question. If you modify the engines/equipment to make them identical, you must completely follow the original manufacturer’s written instructions.

(2) We will tell you in writing if we find the information insufficient to show that the engines/equipment are eligible for the identical configuration exemption. We will then not consider your request further until you address our concerns.

■ 297. Amend § 1068.325 by revising the introductory text, paragraphs (a) through (c), (e), and (g) to read as follows:

**§ 1068.325 Temporary exemptions for imported engines/equipment.**

You may import engines/equipment under certain temporary exemptions, subject to the conditions in this section. We may ask U.S. Customs and Border Protection to require a specific bond amount to make sure you comply with the requirements of this subpart. You may not sell or lease one of these exempted engines/equipment while it is in the United States except as specified in this section or § 1068.201(i). You must eventually export the engine/equipment as we describe in this section unless it conforms to a certificate of conformity or it qualifies for one of the permanent exemptions in § 1068.315 or the standard-setting part.

(a) *Exemption for repairs or alterations.* You may temporarily import nonconforming engines/equipment solely for repair or alteration, subject to our advance approval as described in paragraph (j) of this section. You may operate the engine/equipment in the United States only as necessary to repair it, alter it, or ship it to or from the service location. Export the engine/equipment directly after servicing is complete, or confirm that it has been destroyed.

(b) *Testing exemption.* You may temporarily import nonconforming engines/equipment for testing if you follow the requirements of § 1068.210, subject to our advance approval as described in paragraph (j) of this section. You may operate the engines/equipment in the United States only as needed to perform tests. The testing

exemption expires one year after you import the engine/equipment unless we approve an extension. The engine/equipment must be exported before the exemption expires. You may sell or lease the engines/equipment consistent with the provisions of § 1068.210.

(c) *Display exemption.* You may temporarily import nonconforming engines/equipment for display if you follow the requirements of § 1068.220, subject to our advance approval as described in paragraph (j) of this section. The display exemption expires one year after you import the engine/equipment, unless we approve your request for an extension. The engine/equipment must be exported (or destroyed) by the time the exemption expires or directly after the display concludes, whichever comes first.

\* \* \* \* \*

(e) *Diplomatic or military exemption.* You may temporarily import nonconforming engines/equipment if you represent a foreign government in a diplomatic or military capacity. U.S. Customs and Border Protection may require that you show your written confirmation from the U.S. State Department that you qualify for the diplomatic or military exemption or a copy of your orders for military duty in the United States. We will rely on the State Department or your military orders to determine when your diplomatic or military status expires, at which time you must export your exempt engines/equipment.

\* \* \* \* \*

(g) *Exemption for partially complete engines.* The following provisions apply for importing partially complete engines and used engines that become new as a result of importation:

(1) You may import a partially complete engine by shipping it from one of your facilities to another under the provisions of § 1068.260(c) if you also apply a removable label meeting the requirements of § 1068.45 that identifies your corporate name and states that the engine is exempt under the provisions of § 1068.325(g).

(2) You may import an engine if another company already has a certificate of conformity and will be modifying the engine to be in its final certified configuration or a final exempt configuration if you meet the labeling and other requirements of § 1068.262. If you are importing a used engine that becomes new as a result of importation, you must meet all the requirements that apply to original engine manufacturers under § 1068.262. You may sell or lease

the engines consistent with the provisions of § 1068.262.

\* \* \* \* \*

■ 298. Amend § 1068.450 by revising paragraph (e) to read as follows:

**§ 1068.450 What records must I send to EPA?**

\* \* \* \* \*

(e) We may post test results on publicly accessible databases and we will send copies of your reports to anyone from the public who asks for them, consistent with § 1068.11.

■ 299. Amend § 1068.601 by revising the introductory text and paragraph (b) to read as follows:

**§ 1068.601 Overview.**

The regulations of this chapter involve numerous provisions that may result in EPA making a decision or judgment that you may consider adverse to your interests. For example, our decisions might require you to pay penalties, or you might consider that our decisions will limit your business activities or put you at a competitive disadvantage. As specified in the regulations in this chapter, this might involve an opportunity for an informal hearing or a formal hearing that follows specific procedures and is directed by a Presiding Officer. The regulations in this chapter generally specify when we would hold a hearing. In limited circumstances, we may grant a request for a hearing related to adverse decisions regarding regulatory provisions for which we do not specifically describe the possibility of asking for a hearing.

\* \* \* \* \*

(b) For other issues where the regulation allows for a hearing in response to an adverse decision, you may request an informal hearing as described in § 1068.650. Sections 1068.610 through 1068.630 describe

when and how to request an informal hearing under various circumstances.

\* \* \* \* \*

■ 300. Add § 1068.630 to read as follows:

**§ 1068.630 Request for hearing—allowable maintenance.**

(a) Any manufacturer may request an informal hearing as described in § 1068.650 in response to our decision to identify allowable maintenance associated with new technology as part of the certification process.

(b) You must send your hearing request in writing to the Designated Compliance Officer no later than 30 days after we publish our decision in the **Federal Register**. If the deadline passes, we may nevertheless grant you a hearing at our discretion.

(c) Your hearing request must include the information specified in § 1068.610(d).

(d) We will approve your request for an informal hearing if we find that your request raises a substantial factual issue in the decision we made that, if addressed differently, could alter the outcome of that decision.

■ 301. Redesignate appendix I to part 1068 as appendix A to part 1068 and amend newly redesignated appendix A by revising the introductory text and paragraph IV to read as follows:

**Appendix A to Part 1068—Emission-Related Components**

This appendix specifies emission-related components that we refer to for describing such things as emission-related warranty or maintenance or requirements related to rebuilding engines. Note that inclusion of a component in Section III of this Appendix does not make it an emission-related component for engines/equipment that are not subject to evaporative emission standards.

\* \* \* \* \*

IV. Any other part or system that meets the definition of critical emission-related component.

**Appendix II to Part 1068 [Redesignated as Appendix B to Part 1068]**

■ 302. Redesignate appendix II to part 1068 as appendix B to part 1068.

**Appendix III to Part 1068 [Redesignated as Appendix C to Part 1068]**

■ 303. Redesignate appendix III to part 1068 as appendix C to part 1068.

**PART 1090—REGULATION OF FUELS, FUEL ADDITIVES, AND REGULATED BLENDSTOCKS**

■ 304. The authority citation for part 1090 continues to read as follows:

**Authority:** 42 U.S.C. 7414, 7521, 7522–7525, 7541, 7542, 7543, 7545, 7547, 7550, and 7601.

**Subpart P [Amended]**

■ 305. Revise § 1090.1550 to read as follows:

**§ 1090.1550 Requirements for gasoline dispensing nozzles used with motor vehicles.**

The following requirements apply for any nozzle installation used for dispensing gasoline into motor vehicles:

(a) Nozzles must meet the following hardware specifications:

(1) The outside diameter of the terminal end must not be greater than 21.3 mm.

(2) The terminal end must have a straight section of at least 63 mm.

(3) The retaining spring must terminate at least 76 mm from the terminal end.

(b) The dispensing flow rate must not exceed a maximum value of 10 gallons per minute. The flow rate may be controlled through any means in the pump/dispenser system, as long as it does not exceed the specified maximum value.

[FR Doc. 2022–27957 Filed 1–11–23; 4:15 pm]

**BILLING CODE 6560–50–P**